

de

Sichere Diagnose. Zeitsparende Reparatur. Bosch-Diagnostics und Ersatzteile.

Aus einer Hand: Diagnostics, Teile und Services. Bosch bietet der Werkstatt ein Komplettprogramm zur Steigerung von Effizienz und Qualität in der täglichen Arbeit.

Vom weltweit aktiven Entwickler und führenden Hersteller von Kfz-Systemtechnik kommen die Ersatzteile in bekannter Original-Qualität.

Kompetenz und Qualität – für die Zukunft Ihrer Werkstatt.

en

Reliable diagnosis. Time-saving repairs. Bosch diagnostics and service parts.

From a single source: Diagnostics, parts and services. Bosch has a complete program available which increases efficiency and quality in the workshop's daily work.

The service parts from the globally active development expert and leading manufacturer of automotive system technology are in renowned Bosch OE quality. Competence and quality: Assuring your workshop's future success.

fr

Diagnostic fiable. Réparation rapide. Diagnostics et pièces de rechange Bosch.

À partir d'une source unique: diagnostic, pièces et services. Bosch propose aux réparateurs une gamme complète qui améliore au quotidien l'efficacité et la qualité du travail.

En tant que concepteur présent dans le monde entier et leader dans la fabrication de systèmes pour automobiles, ses pièces de rechange sont reconnues pour offrir la qualité des pièces d'origine.

it

Diagnosi sicure. Riparazioni rapide. Diagnostica, ricambi e formazione: tutto da un unico fornitore.

Tutto da un unico fornitore: diagnostics, componenti e service. Bosch offre all'officina un programma completo per migliorare l'efficienza e la qualità nel lavoro quotidiano.

Lo sviluppatore attivo a livello mondiale e costruttore leader di sistemi automobilistici offre ricambi di comprovata qualità originale. Competenza e qualità, quindi, per il futuro dell'officina.

es

Diagnóstico seguro. Ahorro de tiempo en la reparación. Diagnosis Bosch y piezas de recambio.

De un solo proveedor: diagnósticos, repuestos y servicios. Bosch ofrece al taller un programa completo para incrementar la eficiencia y la calidad del trabajo diario.

De activos desarrolladores de todo el mundo y fabricantes de sistemas técnicos para el automóvil proceden los repuestos en la conocida calidad original. Competencia y calidad para el futuro de su taller.



2016 | 2017



Bosch parts fast and easy on:
www.bosch-automotive-catalog.com

2016 | 2017



BOSCH

☎ 1 987 720 410/201511

AA/MK12 – 11.2015 – Int

© 2015 Robert Bosch GmbH
Automotive Aftermarket
Postfach 41 09 60
76225 Karlsruhe

Token fee: € 10,00

www.bosch.de/aa

Editorial closing: 15. 09. 2015
Subject to change without notice. Please direct questions and comments to our Authorized Representative in your country.
This edition supersedes all previous editions.



BOSCH



BOSCH



Inhalt / Contents / Sommaire / Indice / Índice Inhoud / Innehåll / Conteúdo Obsah / Содержание

Angebot / Offer / Offre / Offerta / Oferta
Assortiment / Utbud / Proposta / Nabídka / Предложение

A2		A75	
A24		A87	
A47		A90	
A58		A91	
A63		A94	
A72		A95	

Verwendung / Applications / Affectation / Impiego / Aplicación
Toepassing / Användning / Utilização / Použití / Применение

B2



Häufigste Bauart: Faustsattel

Dieser Bremsattel wandelt den hydraulischen Druck um und erzeugt damit die Anpresskraft der Bremsbeläge an die Scheiben. In einem beweglich gelagerten Gehäuse presst der Kolben dabei den inneren Bremsbelag direkt auf die Scheibe. Die erzeugte Reaktionskraft verschiebt das Gehäuse und drückt indirekt auch den äußeren Belag gegen die Scheibe. An der Hinterachse wird häufig eine Faustsattelbremse mit integrierter Feststellbremse eingesetzt.

Most common design: Floating caliper

This brake caliper converts the hydraulic pressure and so generates the press force of the brake pads on the disks. Inside a flexibly mounted housing, the piston presses the inner brake pad directly onto the disk. The reaction force generated moves the housing and also indirectly presses the outer pad against the disk. A floating caliper with integrated parking brake is often used on the rear axle.

Type le plus fréquent: Etrier flottant

Cet étrier de frein convertit la pression hydraulique et produit la force de pression des garnitures de frein sur les disques. A l'intérieur d'un boîtier mobile, le piston pousse la garniture de frein intérieure directement contre le disque. La force de réaction produite déplace le boîtier et pousse indirectement la garniture extérieure également contre le disque. On utilise très souvent sur l'essieu arrière un frein à étrier flottant avec frein de stationnement intégré.

Tipo costruttivo più frequente: Pinza flottante

Questa pinza freno trasforma la pressione idraulica e genera in questo modo la forza di spinta delle pastiglie contro i dischi. All'interno di una scatola a supporto mobile il pistone spinge la pastiglia interna del freno direttamente sul disco. La forza di reazione generata sposta la scatola e spinge indirettamente anche la pastiglia esterna contro il disco. Sull'assale posteriore viene frequentemente impiegato un freno a pinza flottante con freno di stazionamento integrato.

Tipo de ejecución más frecuente Pinza flotante

Esta pinza de freno transforma la presión hidráulica y genera así la fuerza de apriete de las pastillas de freno en los discos. En una carcasa alojada en forma móvil, el émbolo apreta en ello la pastilla de freno interior directamente sobre el disco. La fuerza de reacción generada, desplaza la carcasa y apreta indirectamente también la pastilla exterior contra el disco. En el eje trasero se aplica frecuentemente un freno de pinza flotante con freno de estacionamiento integrado.

Bremsattel mit integrierter Feststellbremse

- ① Betätigung Handbremse
- ② Bremsattelgehäuse
- ③ Nachstelleinheit für Handbremsbetätigung
- ④ Kolben
- ⑤ Kolbendichtung
- ⑥ Staubschutzmanschette

Brake caliper with integrated parking brake

- ① Handbrake operation
- ② Brake-caliper housing
- ③ Adjuster unit for handbrake operation
- ④ Piston
- ⑤ Piston seal
- ⑥ Dust-guard sleeve

Etrier de frein avec frein de stationnement intégré

- ① Commande du frein à main
- ② Boîtier de l'étrier de frein
- ③ Unité de rattrapage du jeu de la commande du frein à main
- ④ Piston
- ⑤ Joint de piston
- ⑥ Pare-poussière

Pinza freno con freno di stazionamento integrato

- ① Azionamento freno a mano
- ② Scatola pinza freno
- ③ Unità di regolazione per azionamento freno a mano
- ④ Pistoncino
- ⑤ Guarnizione del pistoncino
- ⑥ Cuffia parapolvere

Pinza de freno con freno de estacionamiento integrado

- ① Accionamiento del freno
- ② Carcasa de la pinza de freno
- ③ Unidad de reajuste para el accionamiento de freno de mano
- ④ Émbolo
- ⑤ Junta de émbolo
- ⑥ Guardapolvo

nl

Zwevend remzadel van schijfrem

sv

Gaffelok

pt

Pinça flutuante

cs

Plovoucí třmen

ru

Плавающий суппорт

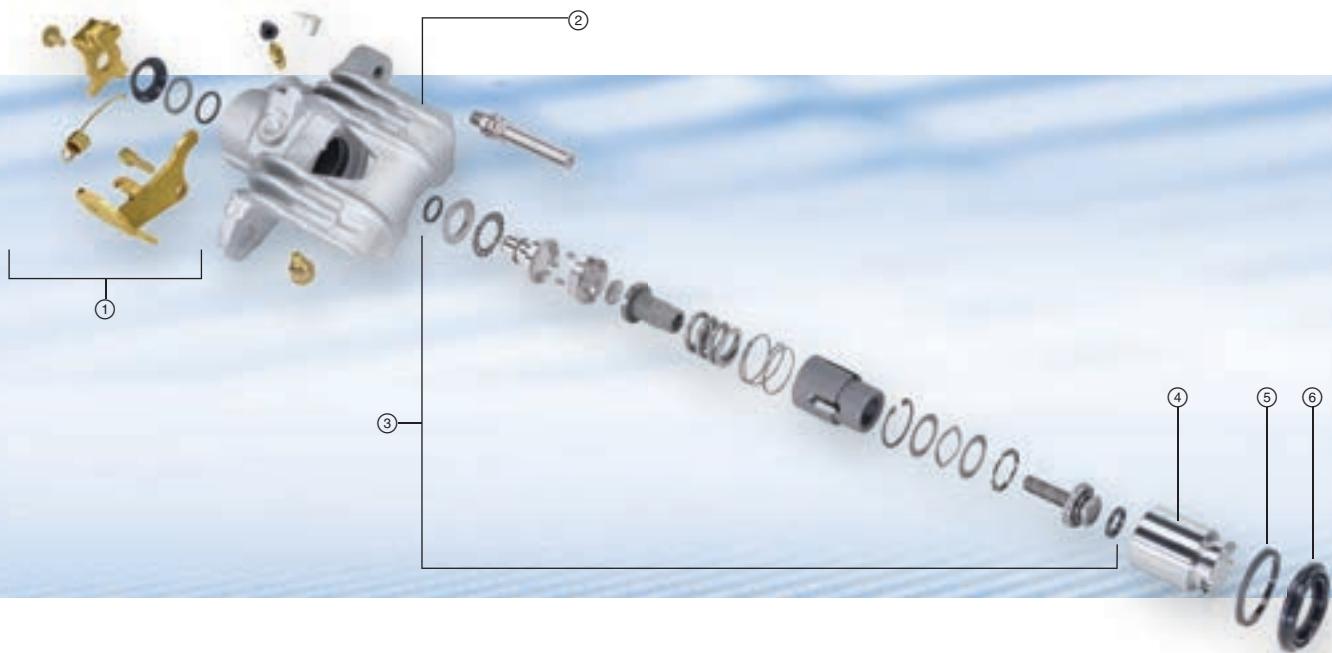

Meest voorkomende bouwwijze: Zwevend remzadel van schijfrem

Dit remzadel verandert de hydraulische druk en genereert hiermee de aandrukkracht van de remvoeringen tegen de schijven. In een flexibel gelagerde behuizing perst de zuiger daarbij de inwendige remvoering rechtstreeks op de schijf. De gegenereerde reactiekracht verschuift de behuizing en drukt indirect ook de uitwendige remvoering tegen de schijf. Op de achteras wordt vaak een schijfrem met zwevend remzadel met geïntegreerde parkeerrem gebruikt.

Remzadel met geïntegreerde parkeerrem

- ① Bediening van de parkeerrem
- ② Remzadelhuis
- ③ Afsteleenheid voor parkeerrembediening
- ④ Zuiger
- ⑤ Zuigerafdichting
- ⑥ Manchet voor stofbescherming

Oftast förekommande konstruktion: Gaffelok

Detta bromsok omvandlar det hydrauliska trycket och alstrar bromsbeläggens anliggningskraft mot skivorna. I ett rörligt lagrat hus pressar kolven det inre bromsbelägget direkt mot skivan. Den alstrade reaktionskraften förskjuter huset och trycker indirekt även det yttre belägget mot skivan. På bakaxeln används ofta ett gaffelok med integrerad parkeringsbroms.

Bromsok med integrerad parkeringsbroms

- ① Manövrering av handbroms
- ② Bromsokshus
- ③ Justerenhet för handbromsmanövrering
- ④ Kolvar
- ⑤ Kolvtätning
- ⑥ Dammskyddsschett

Modelo mais comum: Pinça flutuante

Esta pinça do travão converte a pressão hidráulica, gerando, dessa forma, a força de pressão das pastilhas do travão nos discos. O pistão aperta a pastilha interior do travão directamente contra o disco numa carcaça com apoio móvel. A força de reacção gerada empurra a carcaça e também pressiona, de forma indirecta, a pastilha exterior contra o disco. No eixo traseiro, é usado com frequência um travão com pinça flutuante e travão de mão integrado.

Pinça do travão com travão de mão integrado

- ① Accionamento do travão de mão
- ② Carcaça da pinça do travão
- ③ Afinador do accionamento do travão de mão
- ④ Pistão
- ⑤ Junta do pistão
- ⑥ Gaxeta guarda-pó

Nejčastější konstrukce: Plovoucí třmen

Tento třmen brzdy převádí hydraulický tlak a vytváří přítlačnou sílu brzdových obložení ke kotoučům. U pohyblivě uloženého tělesa přímo přitlačuje píst vnitřní brzdové obložení přímo ke kotouči. Vytvořená síla reakce posunuje těleso a nepřímo přitlačuje ke kotouči také vnější obložení. Na zadní nápravě se často používá brzda s plovoucím třmenem s integrovanou parkovací brzdou.

Třmen brzdy s integrovanou parkovací brzdou

- ① Aktivace ruční brzdy
- ② Těleso třmenu brzdy
- ③ Seřizovací jednotka pro aktivaci ruční brzdy
- ④ Píst
- ⑤ Těsnění pístu
- ⑥ Protiprachová manžeta

Наиболее часто используемая конструкция: плавающий суппорт

Этот суппорт преобразует гидравлическое давление и создает тем самым усилие прижима тормозных накладок к диску. В подвижном корпусе поршень при этом прижимает внутреннюю тормозную накладку непосредственно к диску. Возникающее противоусилие перемещает корпус и прижимает также наружную тормозную накладку к диску. На заднем мосту часто используется дисковый тормоз с плавающим суппортом и интегрированным стояночным тормозом.

Суппорт дискового тормоза с интегрированным стояночным тормозом

- ① Элементы управления ручным тормозом
- ② Корпус суппорта дискового тормоза
- ③ Узел регулировки элементов управления ручным тормозом
- ④ Поршень
- ⑤ Уплотнение поршня
- ⑥ Пылезащитная манжета

de

**Tandem-
Hauptzylinder**

en

**Tandem
master cylinder**

fr

**Maitre-cylindre
tandem**

it

**Cilindro maestro
a tandem**

es

**Cilindro principal
tándem**

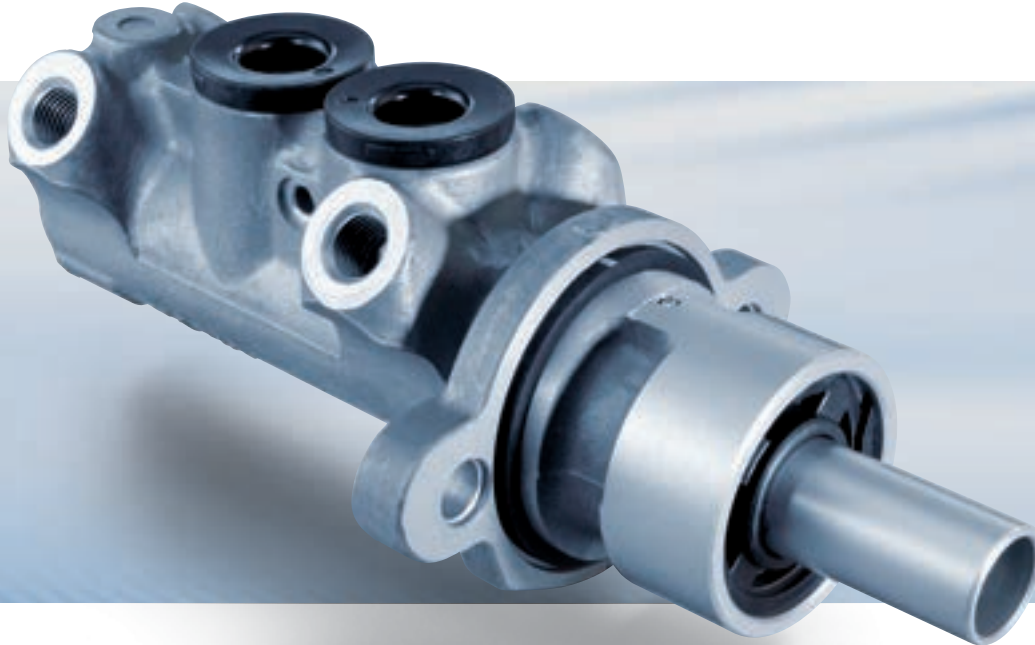

Volle Bremskraft auf lange Sicht

Der Hauptzylinder wandelt den Druck auf das Bremspedal in hydraulischen Druck für zwei getrennte Bremskreise.

Full braking force over the long term

The master cylinder converts the pressure on the brake pedal into hydraulic pressure for two separate brake circuits.

Toute la force de freinage, longtemps

Le maître-cylindre convertit la pression exercée sur la pédale de frein en une pression hydraulique pour deux circuits de freinage séparés.

Piena forza frenante per molto tempo

Il cilindro maestro del freno trasforma la pressione sul pedale del freno in pressione idraulica per due circuiti frenanti separati.

Plena fuerza de frenado a largo plazo

El cilindro principal de freno convierte la presión ejercida sobre el pedal de freno en presión hidráulica para dos circuitos de freno separados.

Tandem-Hauptzylinder

- ① Gehäuse
- ② Federn
- ③ Kolben
- ④ Manschetten

Tandem master cylinder

- ① Housing
- ② Springs
- ③ Piston
- ④ Sleeves

Maitre-cylindre tandem

- ① Boîtier
- ② Ressorts
- ③ Piston
- ④ Manchons

Cilindro maestro a tandem

- ① Scatola
- ② Molle
- ③ Pistoncino
- ④ Manicotti

Cilindro principal tándem

- ① Carcasa
- ② Resortes
- ③ Embolo
- ④ Manguitos

nl

**Tandem-
hoofdcilinder**

sv

**Tandemhuvud-
cylinder**

pt

**Cilindro
principal tandem**

cs

**Tandemový
hlavní válec**

ru

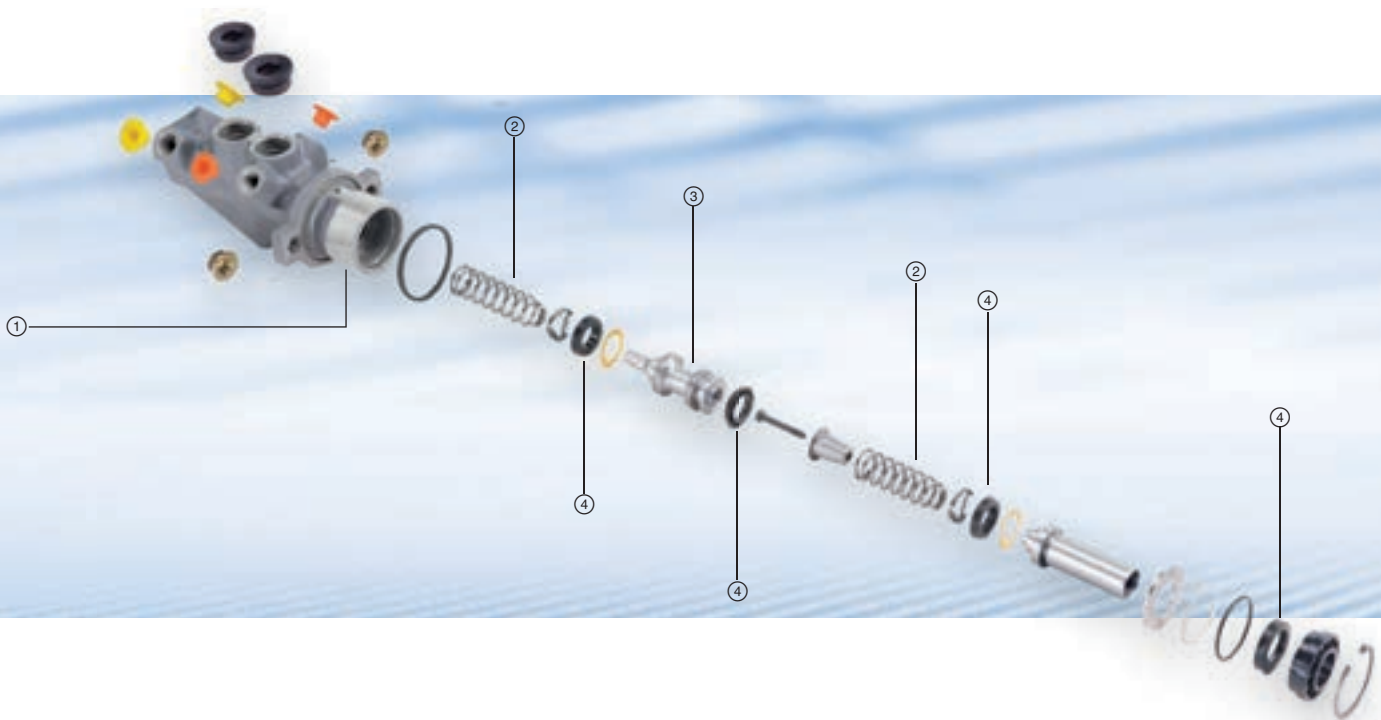
**Главный тормозной
цилиндр tandemного
типа****Volle remkracht op lange termijn.**

De hoofdcilinder verandert de druk op het rempedaal in hydraulische druk voor twee afzonderlijke remcircuits.

Full bromskraft på lång sikt

Huvudcylindern omvandlar trycket mot bromspedalen till ett hydrauliskt tryck för två separata bromskretsar.

Força de travagem total a longo prazo

O cilindro principal converte a pressão do pedal do travão em pressão hidráulica para os dois circuitos do travão separados.

Plná brzdná síla dlouhodobě

Hlavní válec převádí sílu na brzdovém pedálu na hydraulický tlak pro dva samostatné brzdové okruhy.

Полное тормозное усилие надолго

Главный тормозной цилиндр преобразует давление на педаль тормоза в гидравлическое давление для двух отдельных контуров тормозного привода.

Tandem-hoofdcilinder

- ① Behuizing
- ② Veren
- ③ Zuiger
- ④ Manchetten

Tandemhuvudcylinder

- ① Hus
- ② Fjädrar
- ③ Kolvar
- ④ Manschetter

Cilindro principal tandem

- ① Carcaça
- ② Molas
- ③ Pistão
- ④ Gaxetas

Tandemový hlavní válec

- ① Těleso
- ② Pružiny
- ③ Píst
- ④ Manžety

Главный тормозной цилиндр tandemного типа

- ① Корпус
- ② Пружины
- ③ Поршень
- ④ Манжеты

de

**Radbremszylinder
mit integriertem
Regler (CRCI)**

en

**Wheel-brake cylinder
with integrated
regulator (CRCI)**

fr

**Cylindre de roue
correcteur
intégré (CRCI)**

it

**Cilindretto del freno
con regolatore
integrato (CRCI)**

es

**Cilindros de rueda
con regulador
integrado (CRCI)**

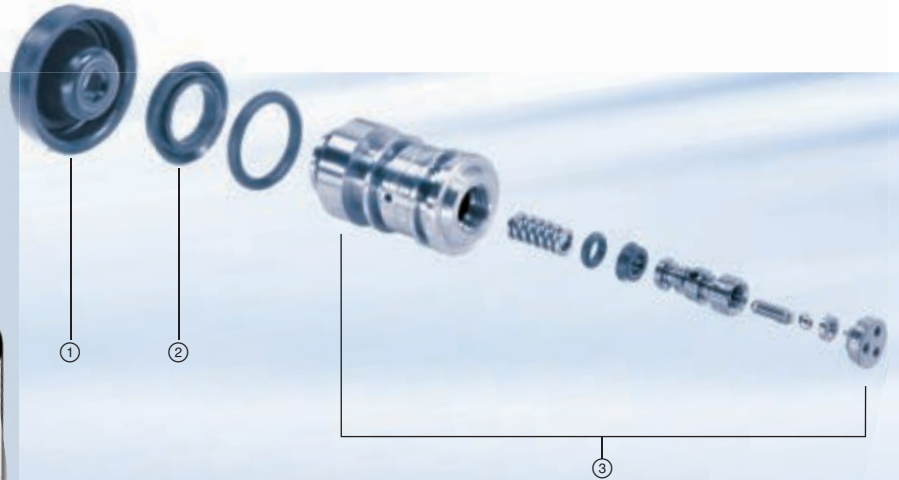
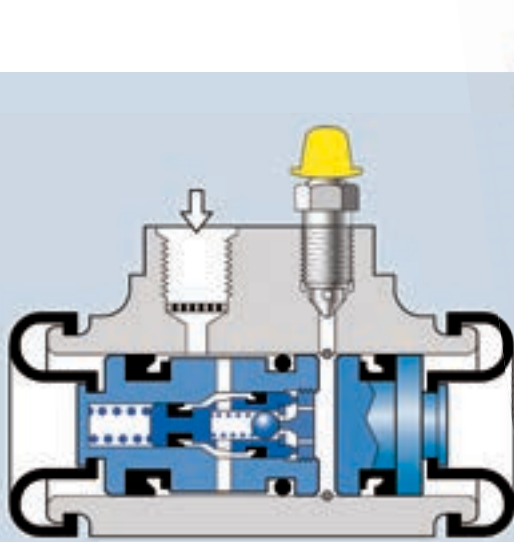

Beim CRCI-Radbremszylinder sitzt die Entlüftungsschraube asymmetrisch zur Achse. CRCI-Radbremszylinder ersparen einen externen Bremskraftregler, reduzieren das Fahrzeuggewicht und ermöglichen eine radselektive Drucksteuerung. Ohne Druckverlust.

CRCI type – the bleeder screw is located asymmetrically to the wheel-brake cylinder axis. With CRCI wheel-brake cylinders, the external braking-force regulator and the wear involved become a thing of the past. The vehicle's weight is reduced, and wheel-selective pressure control becomes possible. All with no loss of pressure.

La vis de purge d'air du cylindre de frein de roue CRCI est excentré par rapport à l'axe. Avec un cylindre de roue CRCI, il n'y a pas de compensateur dans le circuit de freinage – ce qui réduit le poids du véhicule. La correction de l'effort de freinage se fait indépendamment et sans perte sur chaque roue de l'axe arrière.

Nel cilindretto del freno CRCI la vite di spurgo è asimmetrica rispetto all'asse. I cilindretti del freno CRCI non necessitano un correttore di frenata esterno, evitando così una loro usura. Si riduce il peso del veicolo e viene reso possibile un controllo della pressione frenante su ogni singola ruota, senza calo di pressione.

En el cilindro de rueda CRCI el tornillo de purga se asienta asimétricamente respecto al eje. Los cilindros de rueda CRCI no necesitan un regulador de fuerza de frenado externo y evitan su desgaste. Reducen el peso del vehículo y permiten el control de la presión de frenado selectivo por rueda, sin pérdida de presión.

- ① Staubschutzmanschette
- ② Kolbendichtung
- ③ Integrierter Ventilmechanismus zur präzisen Steuerung des Bremsdruckes
- ④ Entlüftungsschraube
- ⑤ Kolben

- ① Dust sleeve
- ② Piston seal
- ③ Incorporated valve mechanism for the precise braking-pressure control
- ④ Bleeder screw
- ⑤ Piston

- ① Pare-poussière
- ② Joint de piston
- ③ Mécanisme de soupape intégré pour un pilotage précis de la pression de freinage
- ④ Vis de purge d'air
- ⑤ Piston

- ① Cuffia parapolvere
- ② Guarnizione del pistoncino
- ③ Meccanismo integrato a valvola per una gestione precisa della pressione frenante
- ④ Vite di spurgo d'aria
- ⑤ Pistoncino

- ① Guardapolvo
- ② Guarnición del émbolo
- ③ Mecanismo de válvulas integrado para un control preciso de la presión de frenado
- ④ Tornillo de purga de aire
- ⑤ Pistón

nl

Wielremcilinder met geïntegreerde regelaar (CRCI)

sv

Hjulbromscylin- der med integrerad regulator (CRCI)

pt

Cilindro do travão da roda com regulador integrado (CRCI)

cs

Brzdový válec kola s integrovaným regulátorem (CRCI)

ru

Колесный тормозной цилиндр с интегрированным регулятором (CRCI)

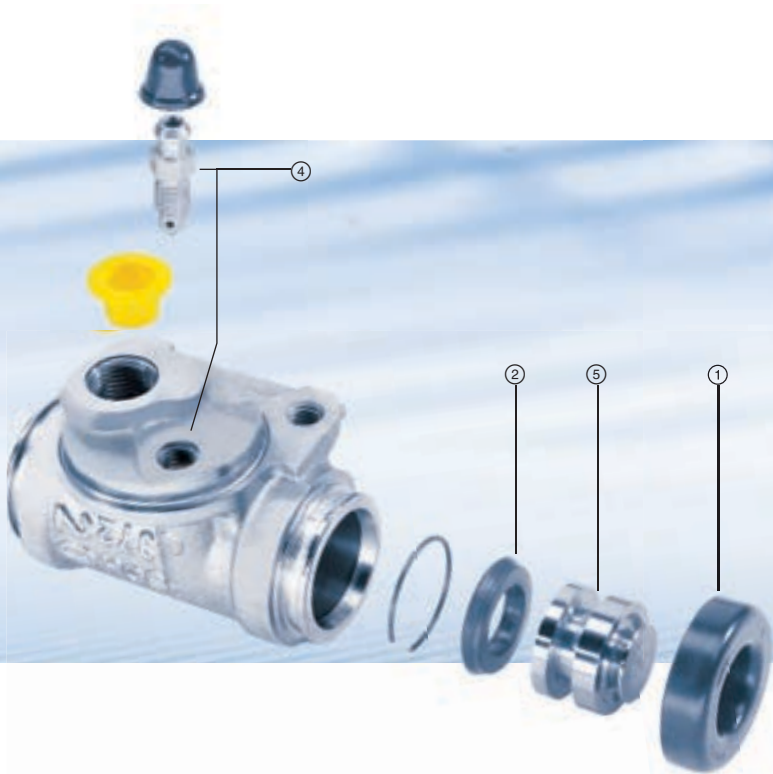

Bij de CRCI-wielremcilinder is de ontluuchtingschroef t.o.v. de as asymmetrisch geplaatst. CRCI-wielremcilinders maken een externe remkrachtregelaar overbodig, verlagen het voertuiggewicht en maken een drukregeling per afzonderlijk wiel mogelijk. Zonder drukverlies.

På CRCI-hjulbromscylin-
dern sitter luftningsskru-
ven asymmetriskt mot
axeln.
CRCI-hjulbromscylin-
dern kräver ingen extern
bromskraftregulator, red-
ucerar fordonets vikt och
möjliggör en hjulsektiv
tryckstyrning. Utan tryck-
förlust.

No cilindro do travão da
roda CRCI existe
um parafuso de sangria
colocado de forma
assimétrica ao eixo.
Os cilindros do travão da
roda CRCI permitem pres-
cindir da utilização de um
regulador da pressão do
travão externo, reduzir
o peso do veículo e um
comando da pressão
exclusivo de cada roda.
Sem perda de pressão.

U brzdového válce kola
CRCI je odvzdušňovací
šroub umístěn
asymetricky k ose.
Brzdové válce kola
CRCI nevyžadují externí
regulátor brzdné síly,
snižují hmotnost vozidla a
umožňují selektivní řízení
tlaku u jednotlivých kol.
Bez tlakové ztráty.

У колесного тормозного
цилиндра CRCI
резьбовая пробка
отверстия для удаления
воздуха расположена
асимметрично к оси.
Благодаря колесным
тормозным цилиндрам
CRCI отпадает
необходимость в
установке отдельного
регулятора тормозных
сил, уменьшается вес
автомобиля и
обеспечивается
индивидуальная
регулировка давления
для каждого колеса. Без
потери давления.

- ① Manchet voor
stofbescherming
- ② Zuigerafdichting
- ③ Geïntegreerde klep-
mechanisme voor een
nauwkeurige regeling
van de remdruk
- ④ Ontluchtingsschroef
- ⑤ Zuiger

- ① Dammskyddsman-
schett
- ② Kolvtätning
- ③ Integrerad ventilmeka-
nism för exakt styrning
av bromstrycket
- ④ Luftningsskruv
- ⑤ Kolvar

- ① Gaxeta guarda-pó
- ② Junta do pistão
- ③ Mecanismo da válvula
integrado para um con-
trole preciso da pres-
são de travagem
- ④ Parafuso de sangria
- ⑤ Pistão

- ① Protiprachová manžeta
- ② Těsnění pístu
- ③ Integrovaný me-
chanismus ventilu
k přesnému řízení
brzdného tlaku
- ④ Odvzdušňovací šroub
- ⑤ Píst

- ① Пылезащитная
манжета
- ② Уплотнение поршня
- ③ Интегрированный
клапанный механизм
для точной
регулировки давления
в тормозном приводе
- ④ Резьбовая пробка
отверстия для
удаления воздуха
- ⑤ Поршень

de

Klassischer
Radbremszylinder

en

Classic wheel-brake
cylinder

fr

Cylindre de roue
classique

it

Cilindretto del freno
classico

es

Cilindro de rueda
clásico

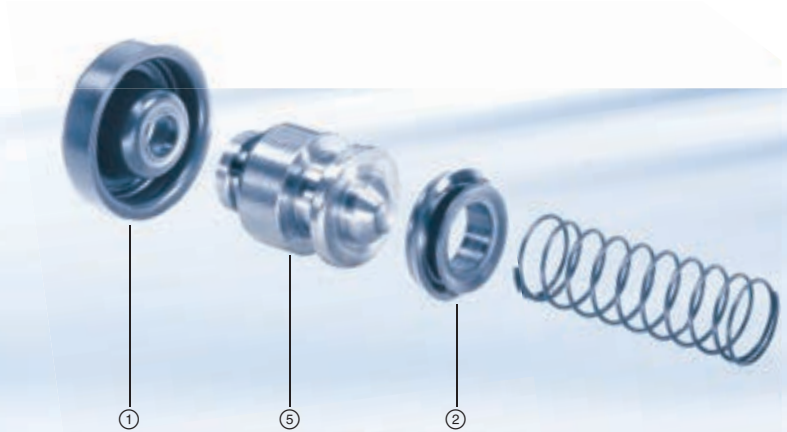
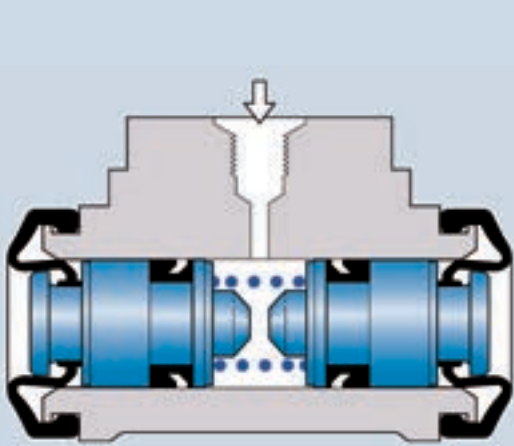

Beim klassischen Radbremszylinder sitzt die Entlüftungsschraube mittig zur Achse des Radbremszylinders.

Classic type – the bleeder screw is located centrally referred to the axis of the wheel-brake cylinder.

La vis de purge d'air du cylindre de roue classique est au centre de l'axe du cylindre de roue.

Nel cilindretto del freno classico la vite di spurgo è situata centralmente rispetto all'asse del cilindretto stesso.

En los cilindros de rueda clásicos se asienta el tornillo de purga centrado respecto al eje del cilindro de rueda.

- ① Staubschutzmanschette
- ② Kolbendichtung
- ④ Entlüftungsschraube
- ⑤ Kolben

- ① Dust sleeve
- ② Piston seal
- ④ Bleeder screw
- ⑤ Piston

- ① Pare-poussière
- ② Kolbendichtung
- ④ Vis de purge d'air
- ⑤ Piston

- ① Cuffia parapolvere
- ② Guarnizione del pistoncino
- ④ Vite di spurgo d'aria
- ⑤ Pistoncino

- ① Guardapolvo
- ② Guarnición del émbolo
- ④ Tornillo de purga de aire
- ⑤ Pistón

nl

Klassieke
wielremcilinder

sv

Klassisk
hjulbromscylinder

pt

Cilindro do travão da
roda clássico

cs

Klasický
brzdový válec kola

ru

Классический
колесный
тормозной цилиндр

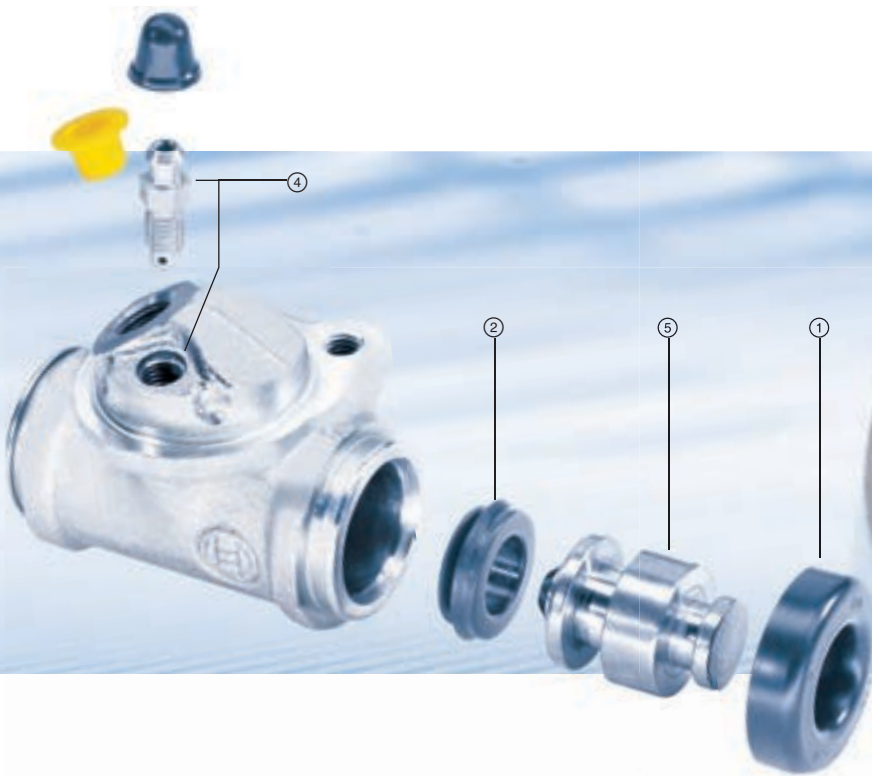

Bij de klassieke wielremcilinder is de ontluchtingsschroef centrisch geplaatst t.o.v. de as van de wielremcilinder.

På den klassiska hjulbromscylindern sitter luftningsskruven centriskt mot hjulbromscylinderns axel.

No cilindro do travão da roda clássico, o parafuso de sangria está colocado a meio do eixo daquele.

U klasického brzdového válce kola je odvzdušňovací šroub umístěn v ose brzdového válce kola.

У классического колесного тормозного цилиндра резьбовая пробка отверстия для удаления воздуха расположена по оси цилиндра.

- ① Manchet voor stofbescherming
- ② Zuigerafdichting
- ④ Ontluchtingsschroef
- ⑤ Zuiger

- ① Dammskyddsman-schett
- ② Kolvtätning
- ④ Luftningsskruv
- ⑤ Kolvar

- ① Gaxeta guarda-pó
- ② Junta do pistão
- ④ Parafuso de sangria
- ⑤ Pistão

- ① Protiprachová manžeta
- ② Těsnění pístu
- ④ Odvzdušňovací šroub
- ⑤ Píst

- ① Пылезащитная манжета
- ② Уплотнение поршня
- ④ Резьбовая пробка отверстия для удаления воздуха
- ⑤ Поршень

Bosch-Electronic Repair Service

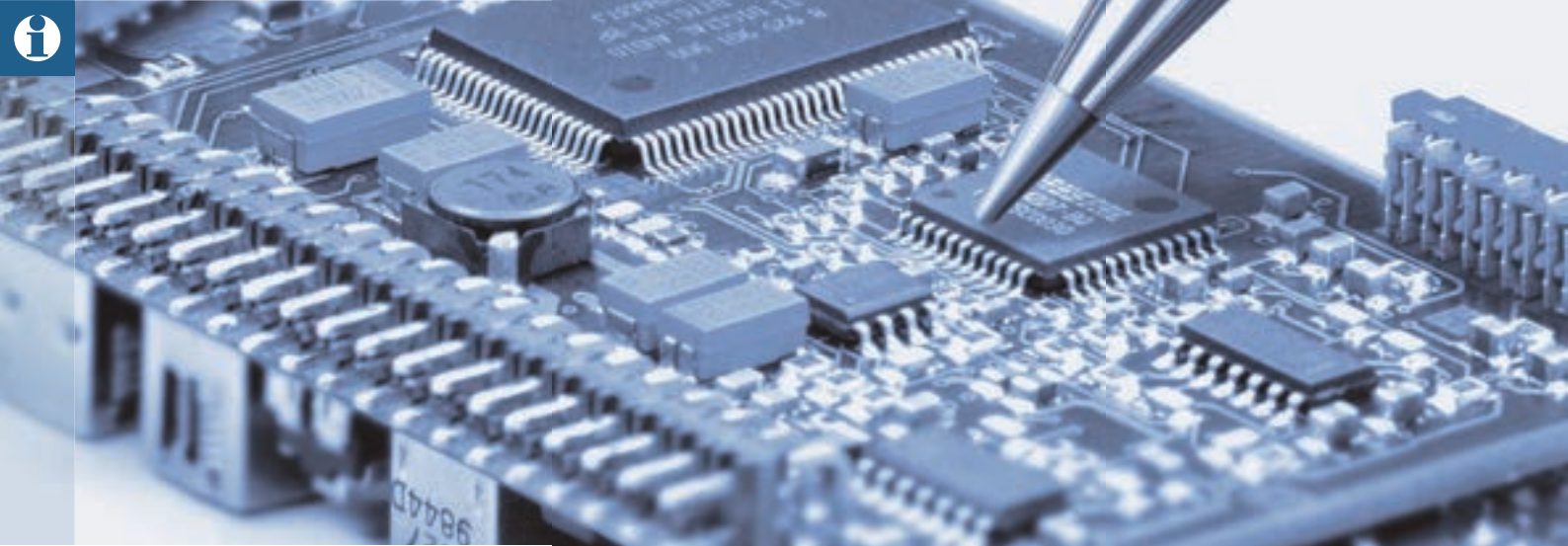
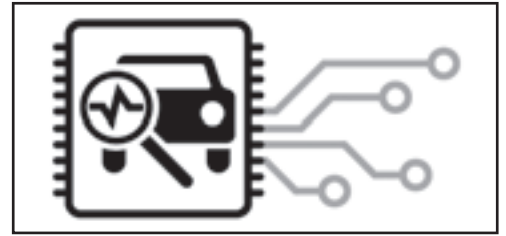

de

Profi-Lösung für Kfz-Werkstätten

Profi-Service für Ihre Kunden

en

Solution for workshops

Professional service for your customers

fr

Solutions professionnelles pour ateliers

Un service de pro pour vos clients

it

La soluzione professionale per le officine

Assistenza professionale per i vostri clienti

es

Soluciones profesionales para talleres

Asistencia profesional para sus clientes

Ihre Vorteile:

- ▶ **Fair Repair:**
Die Reparatur von elektronischen Komponenten als zeitwertgerechte Lösung
- ▶ **Mehr Service:**
Zufriedene Kunden kommen wieder!
- ▶ **Zuverlässig und schnell:**
Versand der reparierten Komponente in der Regel innerhalb von 48 Stunden nach Anlieferung beim Bosch-Electronic Repair Service
- ▶ **Qualität bleibt Qualität:**
Dafür steht Bosch, weltweit führender Erstausrüster und Entwickler von elektronischen Fahrzeugsystemen

Your benefits at a glance:

- ▶ **Fair repair:**
The repair of electronic components as a value-driven solution
- ▶ **Better service:**
Satisfied customers come back!
- ▶ **Reliable and fast:**
Repaired components are usually dispatched within 48 hours of arriving at the Bosch Electronic Repair Service
- ▶ **Quality is quality:**
That is what Bosch, the world's leading original equipment manufacturer and developer of electronic vehicle systems, stands for

Les avantages :

- ▶ **Fair Repair :**
la réparation des composants électroniques adaptée à leur valeur marchande
- ▶ **Davantage de service :**
les clients satisfaits sont des clients fidèles !
- ▶ **Fiable et rapide :**
réexpédition du composant réparé en général 48 heures après son arrivée au Bosch Electronic Repair Service
- ▶ **Des experts de la qualité :**
Bosch, premier équipementier et leader mondial de la conception de systèmes électroniques pour l'automobile

I vantaggi:

- ▶ **Riparazioni a un giusto prezzo:**
la riparazione di un componente difettoso viene effettuata solo se risulta una soluzione adeguata rispetto al valore attuale del componente
- ▶ **Assistenza al top:**
i clienti soddisfatti ritornano!
- ▶ **Affidabilità e velocità:**
spedizione dei componenti riparati di regola entro 48 ore dalla consegna presso il Bosch Electronic Repair Service
- ▶ **La qualità resta qualità:**
è la missione principale di Bosch, fornitore OEM leader mondiale e sviluppatore di sistemi elettronici per autoveicoli

Todas las ventajas:

- ▶ **Reparación fiable:**
una reparación de componentes electrónicos como solución adaptada al valor actual del mercado.
- ▶ **Más servicios:**
los clientes satisfechos vuelven al taller.
- ▶ **Eficacia y rapidez:**
el componente reparado se envía, como norma general, 48 horas después de su llegada al Bosch Electronic Repair Service.
- ▶ **Calidad significa verdadera calidad:**
calidad es sinónimo de Bosch, líder mundial en el desarrollo y fabricación de sistemas electrónicos para vehículos.

Robert Bosch Car Multimedia GmbH
AA-ES/MFR1
Robert-Bosch-Strasse 200
DE-31139 Hildesheim
Telefon 0180 5000 535



www.bosch-repair-service.com



nl

Professionele oplossing voor werkplaatsen

Professionele service voor uw klanten

Uw voordelen in één oogopslag:

- ▶ **Fair Repair:** reparatie van elektronische componenten als oplossing die past bij de restwaarde
- ▶ **Meer service:** tevreden klanten komen terug!
- ▶ **Betrouwbaar en snel:** verzending van gerepareerde componenten doorgaans binnen 48 uur na ontvangst bij Bosch Electronic Repair Service
- ▶ **Kwaliteit blijft kwaliteit:** dat garandeert Bosch, de wereldwijd toonaangevende OEM-fabrikant en ontwikkelaar van elektronische voertuigsystemen

sv

Profffslösning för fordonverkstäder

Profsservice för dina kunder

Dina fördelar:

- ▶ **Ärlig reparation:** Reparation av elektroniska komponenter som marknadsvärdesanpassad lösning
- ▶ **Mer service:** Nöjda kunder kommer tillbaka!
- ▶ **Tillförlitligt och snabbt:** Den reparerade komponenten sänds i regel tillbaka inom 48 timmar efter inleverans hos Bosch Electronic Repair Service
- ▶ **Kvalitet består kvalitet:** Det står Bosch för, globalt ledande leverantör av originalutrustning och utvecklare av elektroniska fordonssystem

pt

Solução profissional para oficinas

Serviço profissional para os seus clientes

As suas vantagens:

- ▶ **Reparação justa:** A reparação de componentes electrónicos como uma solução ajustada ao valor actual
- ▶ **Mais serviço:** Os clientes satisfeitos acabam por voltar!
- ▶ **Seguro e rápido:** Envio dos componentes reparados normalmente no espaço de 48 horas após chegada ao Bosch Electronic Repair Service
- ▶ **Qualidade é sempre qualidade:** Este é o lema da Bosch, fabricante de equipamento de origem e criador líder a nível mundial de sistemas electrónicos para veículos

cs

Profesionální řešení pro servisní dílny osobních vozidel

Profesionální řešení pro vaše zákazníky

Vaše výhody:

- ▶ **Poctivá oprava:** Oprava elektronických komponent jako řešení odpovídající aktuální hodnotě
- ▶ **Více služeb:** Spokojený zákazník přijde opět!
- ▶ **Spolehlivě a rychle:** Expedice opravených komponent zpravidla během 48 hodin po dodání u Bosch Electronic Repair Service
- ▶ **Kvalita zůstává kvalitou:** Za ní stojí Bosch, přední přímá dodavatelská a vývojová společnost elektronických systémů vozidel ve světě

ru

Профессиональное решение для станций техобслуживания автомобилей

Профессиональный сервис для Ваших клиентов

Ваши преимущества:

- ▶ **Корректный ремонт:** Ремонт электронных компонентов как современное решение
- ▶ **Больше сервиса:** Удовлетворенные клиенты придут еще раз!
- ▶ **Надежность и быстрота:** Отправка отремонтированных компонентов, как правило, в течение 48 часов после доставки в Bosch Electronic Repair Service
- ▶ **Качество остается качеством:** Это олицетворяет собой Bosch, ведущий в мире производитель первичной комплектации и разработчик электронных автомобильных систем

de

Der Reparaturprozess

en

The repair process

fr

Le processus de réparation

it

Il processo di riparazione

es

Proceso de reparación



① Diagnose

Eine elektronische Fahrzeugkomponente ist defekt.

② Produktsuche

Suchen Sie die entsprechende elektronische Komponente über die Suchfunktion. Halten Sie dafür am Besten gleich die Bosch-Nummer oder Gerätenummer bereit.

③ Reparaturauftrag

Wir reparieren je nach Gerät zum Festpreis oder erstellen Ihnen einen Kostenvoranschlag.

④ Abholung in Ihrer Werkstatt

Wir beauftragen einen Kurier, der die defekte Komponente kurz darauf bei Ihnen in der Werkstatt abholt.

⑤ Reparatur durch die Profis

Die Elektronik-Spezialisten von Bosch führen die Reparatur durch.

⑥ Auslieferung an die Werkstatt

In der Regel ist die reparierte elektronische Komponente 48 Stunden nach Eingang bei uns wieder auf dem Weg in Ihre Werkstatt.

① Diagnosis

An electronic vehicle component is faulty.

② Product search

Search for the corresponding electronic component using the search function. When doing so, have the Bosch number or device number to hand.

③ Repair order

Depending on the unit, we repair it at a fixed price or create a cost estimate for you.

④ Collection from your workshop

We arrange for a courier to quickly collect the faulty component from your workshop.

⑤ Repair by the professionals

The electronics specialists at Bosch perform the repair.

⑥ Delivery to the workshop

The repaired electronic component is usually on its way back to your workshop 48 hours after we receive it.

① Diagnostic

Un composant électronique d'un véhicule est défectueux.

② Recherche de produit

Recherchez le composant électronique correspondant à l'aide de la fonction de recherche. Ayez la référence Bosch ou la référence de l'appareil à portée de main.

③ Ordre de réparation

Selon l'appareil, nous effectuons la réparation à prix fixe ou nous vous établissons un devis.

④ Enlèvement à votre garage

Nous envoyons un courrier chercher peu de temps après le composant défectueux à votre garage.

⑤ Réparation par des professionnels

Les spécialistes de l'électronique de Bosch effectuent la réparation.

⑥ Livraison au garage

En règle générale, le composant électronique réparé reprend le chemin de votre garage 48 heures après être arrivé chez nous.

① Diagnosi

Un componente elettronico del veicolo è difettoso.

② Ricerca prodotto

Va effettuata la ricerca del corrispondente componente elettronico tramite la funzione di ricerca. A tale scopo è opportuno tenere a portata di mano il numero Bosch o il numero del dispositivo.

③ Ordine di riparazione

A seconda del relativo dispositivo, eseguiamo la riparazione a un prezzo fisso oppure vi forniamo un preventivo dei costi.

④ Ritiro in officina

Incarichiamo un corriere che entro pochissimo tempo provvede a ritirare il componente difettoso nella vostra officina.

⑤ Riparazione da parte di esperti

Gli specialisti in elettronica di Bosch eseguono la riparazione.

⑥ Consegna all'officina

In genere il componente elettronico riparato 48 ore dopo l'arrivo nei nostri laboratori è già di nuovo sul viaggio di ritorno verso l'officina.

① Diagnóstico

Un componente electrónico del vehículo está averiado.

② Búsqueda de producto

Buscar el componente electrónico correspondiente mediante la función de búsqueda. Para ello es conveniente tener a mano el número Bosch o el número del equipo.

③ Orden de reparación

Hacemos reparaciones a un precio fijo según el equipo o elaboramos para usted un presupuesto de gastos.

④ Recogida en su taller

Encargamos a un servicio de paquetería para que pase inmediatamente por su taller a recoger el componente averiado.

⑤ Reparación por profesionales

Los especialistas en sistemas electrónicos de Bosch efectúan la reparación.

⑥ Entrega en el taller

Como norma general, el componente electrónico reparado se encuentra en camino de regreso a su taller sólo 48 horas después de haberlo recepcionado.

nl

Het reparatieproces

sv

Reparationsprocessen

pt

O processo de reparação

cs

Proces opravy

ru

Процесс ремонта

1 Diagnose
Een elektronische voertuigcomponent is defect.

2 Product zoeken
Zoek de desbetreffende elektronische component via de zoekfunctie. Houd hiervoor direct het Bosch-nummer of apparaatnummer bij de hand.

3 Reparatie-opdracht
Wij repareren naar gelang het apparaat voor een vaste prijs of maken een kostenraming.

4 Afhalen in de werkplaats
Wij geven een koerier de opdracht de defecte component korte tijd daarna bij u in de werkplaats op te halen.

5 Reparatie door de expert
De elektronica-specialisten van Bosch voeren de reparatie uit.

6 Levering aan de werkplaats
Over het algemeen is de gerepareerde elektronische component 48 uur na aankomst bij ons weer onderweg naar uw werkplaats.

1 Diagnos
En elektronisk fordonskomponent är defekt.

2 Produktsökning
Sök upp motsvarande elektroniska komponent med sökfunktionen. Bäst är det om du redan håller Bosch-numret eller apparatens nummer i beredskap.

3 Reparationsorder
Beroende på apparat reparerar vi till fast pris eller ger dig en offert.

4 Hämtning i din verkstad
Vi ger en kurir i uppdrag att kort därefter hämta den defekta komponenten hos dig i verkstaden.

5 Reparationer genom proffs
Elektronikspecialisterna hos Bosch utför reparationen.

6 Utleverans till verkstaden
I regel är den reparerade elektroniska komponenten på väg tillbaka till din verkstad inom 48 timmar efter att den kommit fram till oss.

1 Diagnóstico
Um componente eletrônico do veículo está defeituoso.

2 Pesquisa do produto
Procure o respetivo componente eletrónico através da função de busca. Para o efeito, convém ter à mão o número Bosch ou número do aparelho.

3 Ordem de reparação
Consoante o aparelho, efetuamos reparações a preço fixo ou elaboramos um orçamento para si.

4 Recolha na sua oficina
Encarregamos um estafeta de recolher o componente defeituoso pouco depois na sua oficina.

5 Reparação por profissionais
Os peritos em eletrónica da Bosch executam a reparação.

6 Entrega na oficina
Normalmente, devolvemos o componente eletrónico reparado à sua oficina 48 horas após a receção.

1 Diagnostika
Některá elektronická komponenta vozidla je vadná.

2 Vyhledávání produktu
Vyhledání příslušné elektronické komponenty pomocí vyhledávací funkce. Nejlépe je, máte-li k tomu připraveno číslo Bosch nebo číslo přístroje.

3 Zakázka opravy
Podle druhu přístroje opravujeme za pevnou cenu nebo vám zpracujeme cenovou nabídku.

4 Odběr ve vašem servisu
Pověříme kurýra, který krátce poté odebere vadnou komponentu ve vašem servisu.

5 Opravu provádějí profesionálové
Opravu provedou specialisté na elektroniku firmy Bosch.

6 Expedice do servisu
Zpravidla je opravená elektronická komponenta již za 48 hodin od dodání k nám opět na cestě do vašeho servisu.

1 Диагностика
Электронный компонент автомобиля неисправен.

2 Поиск продукта
Найдите соответствующий электронный компонент с помощью функции поиска. Лучше всего, сразу же приготовьте для этого номер Bosch или номер устройства.

3 Заказ на ремонт
В зависимости от устройства мы ремонтируем за фиксированную цену или составляем предварительную смету.

4 Заезд на Вашу СТО
Мы заказываем курьера, который через короткое время забирает неисправный компонент на Вашей СТО.

5 Ремонт профессионалами
Специалисты по электронике компании Bosch проводят ремонт.

6 Доставка на СТО
Как правило, через 48 часов после получения нами отремонтированный электронный компонент уже будет в пути на Вашу СТО.

**ALFA ROMEO**

Brera [939]	B2
GT [937]	B2
GTV [916]	B3
MiTo [955]	B4
Spider [115]	B5
Spider [916]	B5
Spider [939]	B6
4C Spider [960]	B7
4C [960]	B7
33 Berlina [907A]	B7
33 Sportwagon [907B]	B7
145 [930 MY95]	B8
145 [930 MY97]	B9
145 [930 MY99]	B9
146 [930 MY95]	B10
146 [930 MY97]	B11
146 [930 MY99]	B11
147 [937]	B12
155 [167 MY92]	B14
155 [167 MY96]	B15
156 Berlina [932]	B15
156 Sport Wagon Q4 [932]	B17
156 Sport Wagon [932]	B18
156 Sportwagon [932]	B20
159 Berlina Q4 [939]	B20
159 Berlina [939]	B20
159 Sport Wagon Q4 [939]	B21
159 Sport Wagon [939]	B21
159 Sportwagon [939]	B21
164 [164]	B21
166 [936]	B22

**ALPINA
(B.BOVENSIEPEN KG)**

B7 [E65/66]	B23
Roadster [Z8]	B24

AUDI

A1 Sportback [8X]	B24
A1 [8X]	B24
A2 [8Z0]	B25
A3 Cabriolet [8P7]	B25
A3 Cabriolet [8V7]	B25
A3 Limousine [8VS]	B26
A3 Sportback [8PA]	B26
A3 Sportback [8VA]	B27
A3 [8L1]	B27
A3 [8P1]	B28
A3 [8V1]	B29
A4 Allroad [8KH]	B30
A4 Avant [8D5; B5]	B30
A4 Avant [8ED; B7]	B37
A4 Avant [8E5; B6]	B39



A4 Avant [8K5; B8]	B41
A4 Cabriolet [8HE; B7]	B41
A4 Cabriolet [8H7; B6]	B42
A4 Sportback [8TA]	B43
A4 [8D2; B5]	B43
A4 [8EC; B7]	B51
A4 [8E2; B6]	B53
A4 [8K2; B4]	B54
A4 [8K2; B8]	B54
A5 Cabriolet [8F7]	B55
A5 Coupé [8T3]	B56
A5 Sportback [8TA]	B57
A6 Allroad [4BH; C5]	B58
A6 Allroad [4FH; C6]	B58
A6 Avant [4A5; C4]	B59
A6 Avant [4B; C5]	B61
A6 Avant [4B5; C5]	B61
A6 Avant [4B5; C5]	B66
A6 Avant [4B6; C5]	B66
A6 Avant [4F5; C6]	B67
A6 [4A2; C4]	B68
A6 [4B2; C5]	B71
A6 [4B4; C5]	B76
A6 [4F2; C6]	B76
A6 [4F2; C6]	B76
A8 [4D2; D2]	B78
A8 [4E; D3]	B81
Cabriolet [8G7; B4]	B81
Coupé S2 [89; B3]	B82
Coupé [89; B3]	B83
Q3 [8U]	B84
Q5 [8RB]	B84
RS4 Avant [8D5; B5]	B84
RS4 Avant [8ED; B7]	B85
RS4 Avant [8K5; B8]	B85
RS4 Cabriolet [8HE; B7]	B85
RS4 [8EC; B7]	B85
RS5 Cabriolet [8F7]	B86
RS5 Coupé [8T3]	B86
RS6 Avant [4B6]	B86
RS6 Avant [4F5; C6]	B86
RS6 [4B4]	B86
RS6 [4F2; C6]	B86
R8 Spyder GT [427]	B87
R8 Spyder [429]	B87
R8 [422]	B87
R8 [423]	B87
SQ5 [8RB]	B87
S3 Cabriolet [8V7]	B87
S3 Limousine [8VS]	B87
S3 Sportback [8PA]	B87
S3 Sportback [8VA]	B88
S3 [8L1]	B88
S3 [8P1]	B88
S3 [8V1]	B88



S4 Avant [8D5; B5]	B88
S4 Avant [8ED; B7]	B89
S4 Avant [8E5; B6]	B89
S4 Avant [8K5; B8]	B89
S4 Cabriolet [8HE; B7]	B89
S4 Cabriolet [8H7; B7]	B90
S4 [4A2; C4]	B90
S4 [8D2; B5]	B90
S4 [8EC; B7]	B91
S4 [8E2; B6]	B91
S4 [8K2; B8]	B92
S5 Cabriolet [8F7]	B92
S5 Coupé [8T3]	B92
S5 Sportback [8TA]	B92
S6 Avant [4A5; C4]	B92
S6 Avant [4B; C5]	B93
S6 Avant [4B6; C5]	B93
S6 Avant [4F5; C6]	B93
S6 [4A2; C4]	B93
S6 [4B4; C5]	B94
S6 [4F2; C6]	B94
S8 [4D2]	B94
S8 [4E2]	B95
TT Coupé [8J3]	B95
TT Coupé [8N3]	B95
TT Roadster [8J9]	B96
TT Roadster [8N9]	B96
TT RS Coupé [8J3]	B96
TT RS Roadster [8J9]	B97
TTS Coupé [8J3]	B97
TTS Roadster [8J9]	B97
80 Avant [8C5; B4]	B97
80 [8C2; B4]	B98
90 [89; 8A2; B3]	B100
100 Avant [4A5; C4]	B100
100 [4A2; C4]	B101

AUTOBIANCHI

Y 10 [R.92]	B103
-------------	------

BENTLEY

Continental Flying Spur	B103
Continental Flying Spur Speed	B103
Continental GT	B104
Continental GT Speed	B104
Continental GTC	B104
Continental GTC Speed	B104
Continental Supersport	B105
Continental Supersports	B105
Continental Supersports Cabrio	B105
Continental Supersports ISR Cabrio	B105
Flying Spur	B105

**BMW**

i8 [I 12]	B105
Serie X [E 53]	B105
Serie X [E 70]	B106
Serie X [E 71]	B106
Serie X [E 72]	B107
Serie X [E 83]	B107
Serie X [E 84]	B108
Serie X [F 25]	B108
Serie X [F 26]	B108
Serie Z Coupé [E 36/8]	B108
Serie Z Coupé [E 86]	B108
Serie Z [E 36/7]	B109
Serie Z [E 52]	B109
Serie Z [E 85]	B109
Serie Z [E 89]	B110
Serie 1 Cabrio [E 88]	B110
Serie 1 Coupé [E 82]	B110
Serie 1 [E 81]	B110
Serie 1 [E 87]	B111
Serie 1 [F 20]	B111
Serie 1 [F 21]	B112
Serie 1 [F20]	B113
Serie 2 Active Tourer [F 45]	B113
Serie 2 Cabrio [F 23]	B113
Serie 2 Coupé [F 22]	B113
Serie 2 Grand Tourer [F 46]	B114
Serie 3 Cabrio [E 36]	B114
Serie 3 Cabrio [E 46]	B115
Serie 3 Cabrio [E 93]	B116
Serie 3 Compact [E 36]	B116
Serie 3 Compact [E 46]	B116
Serie 3 Coupé [E 36]	B117
Serie 3 Coupé [E 46]	B118
Serie 3 Coupé [E 92]	B119
Serie 3 [E 36]	B120
Serie 3 [E 46]	B122
Serie 3 [E 90]	B123
Serie 3 [F 30]	B124
Serie 3 [F 80]	B126
Serie 3 GT [F 34]	B126
Serie 3 Touring [E 30]	B126
Serie 3 Touring [E 36]	B127
Serie 3 Touring [E 46]	B127
Serie 3 Touring [E 91]	B128
Serie 3 Touring [F 31]	B129
Serie 4 Cabrio [F 33]	B130
Serie 4 Cabrio [F 83]	B131
Serie 4 Coupé [F 32]	B131
Serie 4 Coupé [F 82]	B132
Serie 4 GC [E 36]	B132
Serie 4 GC [F 36]	B132
Serie 5 [E 34]	B132
Serie 5 [E 39]	B133

nl

Inhoudsopgave

sv

Innehållsöversikt

pt

Vista geral
do conteúdo

cs

Přehled obsahu

ru

Оглавление



Serie 5 [E 60]	B136
Serie 5 [F 10]	B138
Serie 5 GT [F 07]	B138
Serie 5 Touring [E 34]	B138
Serie 5 Touring [E 39]	B139
Serie 5 Touring [E 61]	B141
Serie 5 Touring [F 11]	B143
Serie 6 Cabrio [E 64]	B143
Serie 6 [E 63]	B144
Serie 7 [E 32]	B144
Serie 7 [E 38]	B145
Serie 7 [E 65]	B146
Serie 7 [E 66]	B146
Serie 7 [F 01]	B147
Serie 7 [F 02]	B147
Serie 8 [E 31]	B147

BOGDAN

2110	B148
2111	B148
2310	B148

CADILLAC

Catera	B148
--------	------

CHEVROLET

Aveo Hatchback [T300]	B148
Aveo [T300]	B148
Calibra	B148
Captiva [C140]	B149
Corsa Wagon	B149
Corvette Cabrio	B149
Corvette Coupé	B149
Cruze Hatchback [J305]	B149
Cruze [J300]	B149
Cruze Station Wagon [J308]	B149
Evanda [V200]	B149
Lacetti [J200]	B150
Lanos	B150
Matiz [M200]	B150
Niva	B150
Niva [212360]	B150
Nubira [J200]	B151
Nubira Wagon [J200]	B151
Optra Hatchback [J200]	B151
Rezzo [U100]	B151
Spark [M200]	B151
Tavera	B152
Trax	B152

CHRYSLER

Neon [PL]	B152
-----------	------

CITROEN

AX	B152
----	------



Berlingo [B9]	B153
Berlingo [M49]	B154
Berlingo [M59]	B155
C 15	B157
C 25	B157
C-Elysee	B157
C1 [B0]	B158
C1 [B4]	B158
C2 [A6]	B159
C3	B159
C3 [A8]	B159
C3 [A31]	B160
C3 [A51]	B160
C3-Pluriel [A42]	B162
C4 [B5]	B162
C4 [B71]	B164
C4 Cactus [E3]	B164
C4 Coupé [B5]	B164
C4 Grand Picasso [B58]	B166
C4 Picasso [B58]	B166
C4 Sedan [B5]	B167
C5 Break [X3]	B168
C5 Break [X4]	B168
C5 Tourer [X7]	B169
C5 [X3]	B169
C5 [X4]	B169
C5 [X7]	B170
C6 [X6]	B170
C8 [V3]	B170
DS3 [A5]	B171
DS3 [A55]	B171
DS3 Cabrio [A56]	B172
DS4 [B75]	B172
DS5 [B81]	B173
Evasion [U60]	B173
Jumper	B174
Jumper [U5]	B174
Jumper [U6]	B175
Jumper [U9]	B175
Jumper [23]	B175
Jumpy [G9]	B177
Jumpy [U64]	B177
Picasso	B178
Saxo [S8]	B179
Xsara Break [N6]	B180
Xsara Break [N7]	B181
Xsara Coupé [N6]	B181
Xsara Coupé [N7]	B182
Xsara [N6]	B183
Xsara [N7]	B184
Xsara Picasso	B185
Xsara Picasso [N68]	B185
ZX	B186
ZX [N20/N21]	B186

**DACIA**

Duster [HS]	B190
Logan [LS]	B190
Logan MCV [KS/FS]	B190
Logan Pick-Up [US]	B191
Sandero [BS]	B191
Serie 1300	B191

DAEWOO

Espero [KLEJ]	B191
Evanda	B191
Korando [KJ]	B191
Lacetti [J200]	B192
Lacetti [T200]	B192
Lanos Hatchback [T100]	B192
Lanos II	B192
Lanos [T100]	B192
Leganza [V100]	B193
Matiz	B193
Matiz [M100]	B193
Musso [FJ]	B193
New Prince	B194
Nexia	B194
Nexia Hatchback [KLETN]	B194
Nexia [KLETN]	B194
Nubira Hatchback [J100]	B194
Nubira [J100]	B194
Nubira [J150]	B195
Nubira [J200]	B195
Nubira Station Wagon [J100]	B195
Nubira Station Wagon [J150]	B195
Nubira Station Wagon [J200]	B195
Rezzo [U100]	B195

DAIHATSU

Charade [G2]	B196
Copen [81]	B196
Cuore [L2]	B196
Delta	B196
Materia	B196
Sirion II [M3]	B197
YRV	B197

DODGE

Caravan [RS]	B197
Journey [JC]	B198
Neon [PL]	B198

FERRARI

456	B198
512	B198

FIAT

Albea [172]	B198
-------------	------



Barchetta [183]	B199
Brava	B199
Brava [182 MY 95]	B199
Brava [182 MY 98]	B200
Bravo [182 MY95]	B201
Bravo [182 MY98]	B202
Bravo [198]	B203
Bravo [198 MY07]	B203
Bravo [198 MY10]	B204
Cinquecento [170]	B204
Coupé [175 MY93]	B204
Coupé [175 MY96]	B205
Croma [154 MY90]	B205
Croma [194 MY05]	B206
Doblo	B206
Doblo Cargo [223..]	B206
Doblo Cargo [223]	B207
Doblo Cargo [263]	B207
Doblo [Fase I]	B208
Doblo [223 MY00]	B208
Doblo [223 MY05]	B209
Doblo [263]	B209
Ducato	B210
Ducato Cargo	B210
Ducato Minibus	B211
Ducato 10 [230]	B211
Ducato 10 [290]	B213
Ducato 11 [244]	B214
Ducato 11 [250]	B215
Ducato 12 [290]	B216
Ducato 14 [230]	B216
Ducato 14 [290]	B218
Ducato 15 [244]	B219
Ducato 15 [250]	B221
Ducato 17 [250]	B222
Ducato 18 [230]	B223
Ducato 18 [244]	B224
Ducato 18 [290]	B225
Ducato 20 [250]	B225
Ducato 110 [250]	B226
Ducato 115 [250]	B227
Ducato 130 [250]	B227
Ducato 140 [290]	B227
Ducato 150 [250]	B227
Ducato 180 [250..]	B228
Ducato [290]	B228
Fiorino Furgao	B229
Fiorino [146..]	B229
Fiorino [225..]	B230
Fiorino [225]	B230
Grande Punto [199]	B230
Idea [350]	B231
Linea	B232
Linea [110]	B232
Linea [323]	B232

de

Inhaltsübersicht (Fortsetzung)

en

Contents overview (continued)

fr

Sommaire (suite)

it

Indice (seguito)

es

Índice (continuación)



Marea	B233
Marea Weekend	B233
Marea [185]	B233
Marengo [259..]	B235
Marengo [285..]	B236
Multipla [186..]	B236
Palio	B237
Palio [Fase I]	B237
Palio [Fase II]	B238
Palio Weekend [Fase I]	B238
Palio Weekend [178..]	B239
Palio [178..]	B240
Panda Cross [312]	B242
Panda [141..]	B242
Panda [169..]	B243
Panda [169]	B244
Panda [312..]	B244
Petra [172..]	B245
Punto Cabrio [176]	B245
Punto Evo [199]	B246
Punto Grande Abarth SS [199]	B246
Punto Grande Abarth [199]	B247
Punto Grande [199]	B247
Punto GT [176]	B249
Punto Van [276]	B250
Punto Van [288]	B250
Punto [176]	B252
Punto [188]	B254
Punto [199]	B257
Qubo [300..]	B258
Quobo [300]	B258
Scudo [222..]	B258
Scudo [270]	B259
Scudo [272..]	B259
Sedici [189]	B259
Seicento [187..]	B260
Siena	B260
Siena [Fase I]	B260
Siena [172..]	B261
Siena [178..]	B261
Stilo	B261
Stilo Multi Wagon [192..]	B262
Stilo [192..]	B264
Strada	B266
Strada [Fase I]	B266
Strada [Fase II]	B267
Strada [278]	B267
Talento	B268
Tempra	B268
Tempra SW [159]	B268
Tempra [159]	B270
Tipo	B271
Tipo [160..]	B271
Ulysse [179..]	B273
Ulysse [220..]	B273



Uno Van [246..]	B274
Uno [146..]	B274
Uno [158..]	B275
500 [312]	B275
500C [312]	B276
500L [199]	B277
500X [334]	B277
FORD	
B-Max [12]	B278
C-MAX [07]	B278
C-MAX [11]	B278
Cougar	B278
Courier	B279
Courier [PC]	B279
Courier [PD]	B279
Courier [PE]	B279
Econovan	B279
Econovan [JG]	B279
Escort	B280
Escort [Fase I]	B280
Escort [Fase II]	B280
Escort Hobby	B280
Escort Sedan	B280
Escort Sedan [Fase II]	B280
Escort SW	B280
Escort VII Cabrio [95]	B281
Escort VII Express [95]	B281
Escort VII RS [95]	B281
Escort VII Turnier [95]	B281
Escort VII XR3i Cabrio [95]	B282
Escort VII [95]	B282
Escort V/VI Cabrio [91]	B282
Escort V/VI Express [91]	B282
Escort V/VI RS [91]	B283
Escort V/VI Turnier [91]	B283
Escort V/VI XR3i Cabrio [91]	B283
Escort V/VI XR3i [91]	B283
Escort V/VI [91]	B283
Explorer [EX]	B284
Fairlane [NC II]	B284
Fairlane [NL]	B284
Falcon	B284
Falcon [AU III]	B284
Falcon [EF]	B284
Falcon Utility [XG]	B284
Festiva Hatchback [WA]	B284
Fiesta	B284
Fiesta [Fase II]	B285
Fiesta III Courier [89]	B285
Fiesta III [89]	B285
Fiesta IV Courier [96]	B286
Fiesta IV [96]	B287
Fiesta V [02]	B287
Fiesta VI [08]	B288





Fiesta VII [13]	B289
Focus C-MAX [04]	B289
Focus [Fase I]	B290
Focus [GA]	B290
Focus I Turnier [99]	B290
Focus I [99]	B291
Focus II Cabriolet [06]	B292
Focus II Turnier [04]	B292
Focus II Turnier [08]	B293
Focus II [04]	B293
Focus II [08]	B293
Focus III Turnier [11]	B294
Focus III [11]	B294
Focus Sedan	B294
Focus Sedan [Fase I]	B294
Fusion [02]	B294
Galaxy [00]	B295
Galaxy [95]	B295
Ka [Fase I]	B295
Ka [08]	B296
Ka [97]	B296
Kuga [08]	B296
Kuga [13]	B296
Maverick [UDS, UNS]	B296
Mondeo	B296
Mondeo I Turnier [93]	B296
Mondeo I [93]	B297
Mondeo I [97]	B297
Mondeo II Turnier [97]	B298
Mondeo II [97]	B299
Mondeo III Turnier [01]	B299
Mondeo III [01]	B302
Mondeo IV Turnier [07]	B305
Mondeo IV [07]	B305
Probe	B305
Puma [ECT]	B305
Ranger	B306
Ranger [12]	B306
Scorpio II Turnier [95]	B306
Scorpio II [95]	B306
Serie F	B306
Streetka	B307
Taurus	B307
Tourneo Connect [02]	B307
Tourneo Courier	B307
Transit	B307
Transit Connect [02]	B307
Transit Courier	B307
Transit Custom [13]	B308
Transit Euroline [00]	B308
Transit Euroline [06]	B308
Transit Euroline [12]	B309
Transit Euroline [95]	B309
Transit Nugget [00]	B309
Transit Nugget [06]	B310



Transit Nugget [12]	B310
Transit Nugget [95]	B310
Transit Tourneo Custom [13]	B311
Transit Tourneo [00]	B311
Transit Tourneo [06]	B311
Transit Tourneo [12]	B312
Transit Tourneo [95]	B312
Transit [00]	B313
Transit [06]	B325
Transit [12]	B329
Transit [14]	B330
Transit [92]	B330
Transit [95]	B331
GAZ	
GAZelle [2705,3221,3302]	B333
GAZelle [3705,3221,3302]	B333
Sobol [2217,2310,2752]	B333
HOLDEN	
Astra [G]	B333
Barina [XC]	B334
Jackaroo [U8]	B334
Rodeo [RA]	B334
Rodeo 4x4 [TF]	B334
HONDA	
Accord	B334
Accord Aerodeck [CB/CC/CD/CE]	B335
Accord [CF]	B335
Accord [CG/CH/CL]	B335
Accord [CL/CN/CM]	B335
Accord [CM]	B335
Accord Coupé [CB/CC/CD/CE]	B336
Accord Coupé [CG]	B336
Accord Hatchback [CG/CH/CL]	B336
Accord Sedan [CC]	B336
Accord Sedan [CE/CF]	B336
Accord Sedan [CG/CH/CL]	B337
Accord Tourer [CL/CN/CM]	B337
City	B337
City [GM]	B338
City New [MN]	B338
City Sedan [FD]	B338
Civic	B338
Civic Aerodeck [MB/MC]	B338
Civic Coupé	B338
Civic Coupé [EJ]	B339
Civic CRX [EG/EH]	B339
Civic Fastback [MA]	B339
Civic Fastback [MB/MC]	B339
Civic Hatchback [EG/EH]	B339
Civic Hatchback [EJ/EK]	B340
Civic Hatchback [EU/EP]	B340
Civic Hatchback [FK/FN]	B340



nl

Inhoudsopgave
(vervolg)

	
Civic Sedan	B341
Civic Sedan [EG/EH]	B341
Civic Sedan [EJ/EK]	B341
Civic Sedan [ES]	B341
Civic Sedan [FB]	B341
Civic Sedan [FD]	B341
Civic Sedan [FD6]	B341
Civic Shuttle [EC/ED/EE]	B342
Civiv Sedan [EJ/EK]	B342
Concerto Hatchback	B342
Concerto Sedan	B342
CR-V	B342
CR-V [RD]	B342
CR-V [RE]	B342
CR-Z [ZF]	B343
Fit	B343
FR-V [BE]	B343
HR-V [GH]	B343
Integra Type R [DC]	B344
Jazz [GD]	B344
Jazz [GE/GG]	B344
Legend	B344
Prelude [BB]	B344
Stream [RN]	B344
HYUNDAI	
Accent	B345
Accent blue [RB]	B345
Accent Hatchback [LC]	B345
Accent Hatchback [MC]	B345
Accent Hatchback [X3]	B345
Accent [LC]	B345
Accent [MC, MCT]	B346
Accent [RB]	B346
Accent [X3]	B346
Atos [MX]	B346
Atos Prime [MX]	B346
Avante [J2]	B347
Azera	B347
Coupé [GK]	B347
Coupé [RD]	B347
Elantra	B347
Elantra Hatchback [XD]	B347
Elantra [HD]	B348
Elantra [J1]	B348
Elantra [J2]	B348
Elantra [MD, UD]	B348
Elantra [XD]	B348
Excel Hatchback [X3]	B349
Excel [X3]	B349
Getz [TB]	B349
Grace	B349
Grandeur [TG]	B349
H 100	B350
ix35 [LM, EL]	B350



sv

Innehållsöversikt
(fortsättning)

	
ix35 [LM, EM]	B350
ix35 [LM, EL]	B350
i20 [GB]	B350
i30 Coupé [GD]	B350
i30 CW [FD/FDH]	B350
i30 CW [GD]	B350
i30 [FD/FDH]	B350
i30 [GD]	B351
i40 CW [VF]	B351
i40 [VF]	B351
Lantra [J1]	B351
Lantra [J2]	B351
Lantra Kombi [J2]	B351
Matrix [FC]	B352
Pony [X3]	B352
Santa Fe [CM]	B352
Santa Fe [SM]	B352
Satnta Fe [DM]	B352
Solaris Hatchback [RB]	B352
Solaris [RB]	B352
Sonata [EF]	B353
Sonata [NF]	B353
Sonata [YF]	B353
Trajet [FO]	B353
Tucson [JM]	B353
Veloster [FS]	B353
Verna [LC]	B353
XG [F]	B354
INFINITI	
EX [J50]	B354
FX [S51]	B354
FX50 [S51]	B354
G Cabrio [HV36]	B354
G Coupé [CV36]	B355
G [V36]	B355
G35 [V35]	B355
M [Y50]	B355
QX [A60]	B356
QX50	B356
QX56 [A60]	B356
QX70 [S51]	B356
Q60 Cabrio	B356
Q60 Coupé	B356
ISUZU	
Frontier [TF140]	B356
Serie N	B357
Serie N [700N]	B357
Trooper [UB]	B357
IVECO	
CityClass	B357
Daily	B357
Daily Chassi	B358

pt

Vista geral
do conteúdo
(continuação)



	
Daily Furgao	B359
Daily MaxiVan	B359
Daily Vetrato	B359
Daily [00]	B359
Daily [06]	B360
Daily [09]	B363
Daily [12]	B365
Daily [14]	B366
Daily [96]	B366
Scudato	B366
JAGUAR	
XJ 12	B367
X-Type	B367
X-Type Estate	B367
JEEP	
Cherokee	B368
Cherokee [XJ]	B368
Grand Cherokee [ZG]	B368
Grand Cherokee [ZJ]	B368
Renegade	B368
KIA	
Carens [FC]	B369
Carens [FG]	B369
Carens [RP]	B369
Carnival [MB]	B369
Cee'd [ED/FF2]	B369
Cee'd [JD]	B369
Cee'd Sporty Wagon [ED/FF2]	B370
Cee'd Sporty Wagon [JD]	B370
Cerato [FE]	B370
Cerato Hatchback [FE]	B370
Cerato Koup [TD]	B370
Cerato [TD]	B370
Creato Koup [TD]	B370
Creato [TD]	B370
K 2500	B370
K 2700	B371
K 2700 [SD]	B371
Magentis [GD]	B371
Magentis [GE]	B371
Mentor II [FX]	B371
Mentor II Hatchback [FX]	B371
Optima	B371
Optima [TF]	B371
Pro Cee'd [ED]	B371
Pro Cee'd [JD]	B372
Rio Hatchback [JB, DE]	B372
Rio Hatchback [UB]	B372
Rio [JB, DE]	B372
Rio [UB]	B372
Sorento [JC]	B372
Spectra Hatchback	B372

cs

Přehled obsahu
(pokračování)

ru

Оглавление
(продолжение)

	
Sportage [JE]	B373
Sportage [SL]	B373
LADA	
Forma	B373
Kalina	B373
Kalina Hatchback	B373
Kalina Kombi	B373
Niva	B373
Priora	B373
Priora Hatchback	B374
Priora Kombi	B374
Samara	B374
Samara Fun	B374
Samara Hatchback	B374
Serie 110	B374
Serie 111	B374
Serie 112	B374
Serie 115	B374
Serie 2100	B375
Serie 21000	B375
Toscana	B375
LANCIA	
Dedra Berlina [835]	B375
Dedra Station Wagon [835]	B377
Delta [831]	B377
Delta [836]	B378
Delta [844]	B378
Kappa Berlina [838]	B379
Kappa Coupé [838]	B379
Kappa Station Wagon [838]	B380
Lybra Berlina [839]	B380
Lybra Station Wagon [839]	B381
Musa [350]	B381
Phedra [179]	B383
Thema Berlina [104]	B383
Thema Station Wagon [104]	B383
Y 10 [156]	B383
Y [840]	B384
Ypsilon [312]	B384
Ypsilon [843]	B384
Zeta [122]	B385
LAND ROVER GROUP	
Defender 90	B385
Defender 110	B386
Defender 130	B386
Discovery I	B386
Discovery III [TAA]	B387
Discovery IV [LA]	B387
Range Rover I	B387
Range Rover II [LP]	B387
Range Rover III [LM L322]	B387
Range Rover IV [LM L322]	B388

de

Inhaltsübersicht
(Fortsetzung)

en

Contents overview
(continued)

fr

Sommaire
(suite)

it

Indice
(seguito)

es

Índice
(continuación)

Range Rover Sport [LS L320] B388

LDV GROUP LIMITED

Maxus B388

LEXUS

ES [V] B388

ES [V6] B389

IS [E2] B389

LX [J8] B389

RC F [C1] B389

RX [U1] B389

MAHINDRA

Scorpio [MI] B389

Thar B389

XUV500 B389

MAZDA

Bongo Wagon B389

BT-50 [UN] B390

CX-7 [ER] B390

Demio [DW] B390

E-Serie B390

Marathon B390

Millenia [TA] B391

MPV [LV] B391

MPV [LW] B391

MX-5 [NA] B391

MX-5 [NB] B391

MX-5 [NC] B391

MX-6 [GE] B392

Premacy [CP] B392

RX-7 Coupé [FD] B392

RX-8 [FE] B393

RX-8 [SE] B393

Serie B B393

Serie B [UF] B393

Serie B [UN] B393

Serie E B393

Tribute B394

Xedos-6 [CA] B394

Xedos-9 [TA] B394

2 [DE] B394

3 [BK] B396

3 [BL] B396

3 Hatchback [BK] B396

3 Hatchback [BL] B396

5 [CR] B396

5 [CW] B396

6 Fastback [GG/GY] B396

6 Fastback [GH] B397

6 [GG/GY] B397

6 [GH] B397

6 Sedan [GG/GY] B398

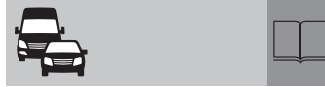

6 Wagon [GG/GY] B398

6 Wagon [GH] B398

121 [DB] B399

121 [JA/JB] B399

121 METRO Wagon [DW] B399

323 Astina [BA] B399

323 Astina Hatchback [BA] B399

323 [BA] B400

323 [BG] B400

323 [BJ] B400

323 Hatchback [BA] B401

323 Hatchback [BG] B401

323 Hatchback [BJ] B401

323 Sedan [BA] B402

323 Sedan [BG] B402

323 Wagon [BW] B402

626 B402

626 Fastback [GF] B402

626 [GE] B403

626 [GF] B404

626 Hatchback [GE] B404

626 Hatchback [GF] B405

626 Wagon [GV] B406

626 Wagon [GW] B406

MERCEDES-BENZ

Classe A [168] B406

MB B407

Serie A [168] B407

Serie A [169] B408

Serie B [245] B409

Serie C (Coupé) [204] B409

Serie C (Sportcoupe) [203] B409

Serie C (T-Modell) [202] B410

Serie C (T-Modell) [203] B411

Serie C [202] B412

Serie C [203] B418

Serie CL (Coupé) [140] B419

Serie CL (Coupé) [215] B419

Serie CLC [203] B420

Serie CLK (Cabrio) [208] B420

Serie CLK (Cabrio) [209] B421

Serie CLK (Coupé) [208] B421

Serie CLK (Coupé) [209] B422

Serie CLS (Coupé) [218] B422

Serie CLS (Shooting Brake) [218] B422

Serie CLS [219] B422

Serie E (Cabrio) [124] B422

Serie E (Cabrio) [207] B423

Serie E (Coupé) [124] B423

Serie E (Coupe) [207] B424

Serie E (Coupé) [207] B424

Serie E (T-Model) [212] B424

Serie E (T-Modell) [124] B425

Serie E (T-Modell) [210] B426

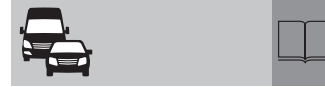

Serie E (T-Modell) [211] B430

Serie E (T-Modell) [212] B431

Serie E [124] B432

Serie E [210] B433

Serie E [211] B438

Serie E [212] B439

Serie G [461] B440

Serie G [463] B440

Serie ML [163] B441

Serie S (Coupé) [140] B441

Serie S (Coupé) [217] B442

Serie S [140] B442

Serie S [220] B443

Serie S [222] B445

Serie SL [129] B445

Serie SL [230] B446

Serie SLK [170] B447

Serie SLK [171] B447

Serie SLR (Coupé) [199] B447

Serie SLR (Roadster) [199] B447

Serie SLR [190] B447

Serie V [638] B447

Serie 190 [201] B448

Sprinter B448

Sprinter [NCV3] B449

Sprinter [T1N] B453

Vaneo [414] B458

Viano [639] B458

Vito [638] B459

Vito [639] B460

2t [T1] B461

3t [T1] B462

4t [T1] B462

311 Sprinter [909] B463

411 Sprinter [909] B463

MG

MG TF B463

MGF B463

ZR B463

ZS B464

ZT B464

ZT-Tourer B464

MINI (BMW)

Cooper Cabrio [R 52] B465

Cooper Cabrio [R 57] B465

Cooper Cabrio [R 58] B465

Cooper Clubman [R 55] B465

Cooper Clubvan [R 55] B465

Cooper Countryman [R 60] B465

Cooper Coupé [R 58] B465

Cooper [F 55] B465

Cooper [F 56] B466

Cooper One Cabrio [R 52] B466

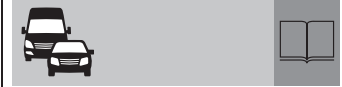

Cooper One Cabrio [R 57] B466

Cooper One Clubman [R 55] B466

Cooper One Countryman [R 60] B466

Cooper One [F 55] B466

Cooper One [F 56] B466

Cooper One [R 50] B466

Cooper One [R 56] B466

Cooper Paceman [R 61] B467

Cooper [R 50] B467

Cooper [R 56] B467

Cooper Roadster [R 59] B467

Cooper S [F 55] B467

Cooper S [R 53] B467

John Cooper Works Cabrio [R 52] B467

John Cooper Works Cabrio [R 57] B467

John Cooper Works Clubman B468

[R 55] B468

John Cooper Works Countryman B468

[R 60] B468

John Cooper Works Coupé [R 58] B468

John Cooper Works Paceman B468

[R 61] B468

John Cooper Works [R 53] B468

John Cooper Works [R 56] B468

John Cooper Works Roadster B468

[R 59] B468

MITSUBISHI

Canter 35 [FB] B468

Carisma [DA] B468

Carisma Hatchback [DA] B469

Colt Cabrio [CZ] B470

Colt [CA/CC] B470

Colt [CJ] B471

Colt [CZ] B471

Eclipse [D2/3] B472

Express [SH] B472

Express [SJ] B472

Express [WA] B472

Galant B472

Galant [EA] B472

Galant [E5...8] B473

Galant Hatchback [E5...8] B473

Galant Station Wagon B474

Galant Station Wagon [EA] B474

Grandis B475

i-MiEV B475

L 200 B475

L 200 Forte [K7] B475

L 200 [KA] B475

L 200 [KB] B475

L 200 [KO-K3] B476



L 200 [K6/K7] B476

L 300 Truck [L] B477

L 300 Truck [P] B477



nl

Inhoudsopgave
(vervolg)

	
L 300 Van [P]	B477
L 300 Wagon [P]	B477
L 400	B478
Lancer	B478
Lancer [CA/CB/CD]	B479
Lancer [CC]	B479
Lancer [CK/CP/CN]	B479
Lancer [CS/CT]	B480
Lancer [CY/CZ]	B480
Lancer [C1/C3]	B480
Lancer [C6/C7]	B480
Lancer EvoX [CY/CZ]	B480
Lancer Evo4 [CK/CP/CN]	B481
Lancer Evo5/6 [CK/CP/CN]	B481
Lancer Evo7 [CS/CT]	B481
Lancer Evo8 [CS/CT]	B481
Lancer Evo9 [CS/CT]	B482
Lancer Hatchback [C6/C7]	B482
Lancer [MG21/41]	B482
Lancer Ralliart [CY/CZ]	B482
Lancer Sedan [CA/CB/CD]	B482
Lancer Sedan [CK/CP/CN]	B483
Lancer Sportback [CX]	B483
Lancer Sportback Ralliart [CX]	B483
Lancer Station Wagon [CA/CB/CD]	B483
Lancer Station Wagon [CS/CT]	B484
Mirage [CE]	B484
Outlander [CU]	B484
Outlander [CW]	B484
Pajero Cabrio [V]	B485
Pajero IO	B485
Pajero [NH/NJ/NK]	B485
Pajero [NJ/NK/NL]	B485
Pajero Pinin [H]	B485
Pajero Sport [K]	B485
Pajero Sport [KH]	B486
Pajero [V]	B486
Pajero [V60; V70]	B487
Pajero [V80; V90]	B487
Sigma	B487
Space Gear	B487
Space Runner	B488
Space Wagon [N]	B488
Spacestar [DG]	B489
Triton [MJ]	B489
3000 GT	B490
NISSAN	
AD Van	B490
Almera Hatchback [N15]	B490
Almera Hatchback [N16E]	B490
Almera [H14/15/17]	B491
Almera Sedan [N15]	B492
Almera Sedan [N16]	B492



sv

Innehållsöversikt
(fortsättning)

	
Almera Sedan [N16E]	B492
Almera Tino [V10M]	B493
Altima Coupé [CL32]	B494
Altima [L31]	B494
Altima [L32]	B494
Altima [U13]	B494
Armada [TA60]	B494
Bluebird	B495
Bluebird [U13]	B495
Cabstar [F 24]	B495
Cabstar [F24]	B495
Cabstar ZZ	B495
Cedric Sedan [Y30]	B495
Cedric Wagon [Y30]	B496
Cefiro	B496
Cube [Z12]	B496
Evalia [M20M]	B496
E20	B496
Frontier	B496
Hardbody [D21]	B496
Hardbody [D22]	B496
Interstar [X70]	B497
Kubistar [X76]	B497
Maxima [A35]	B497
Maxima [J30]	B497
Maxima QX [A32]	B497
Maxima QX [CA33]	B498
Micra CC [K12E]	B498
Micra [K11E]	B498
Micra [K12E]	B498
Micra [K13K]	B499
Murano [Z50]	B499
Murano [Z51]	B499
Note [E11]	B499
Note [E11E]	B500
NP300 [D22SS]	B500
NT 500 [G40M]	B500
NV200 [M20]	B500
NV200 [M20M]	B500
Pathfinder	B500
Pathfinder [D21]	B501
Pathfinder [R50]	B501
Patrol GR [Y60]	B501
Patrol GR [Y61]	B501
Patrol [260]	B502
Pickup [D21]	B502
Pickup [D22]	B503
Prairie Pro [M11]	B504
Primastar [X83]	B504
Primera Hatchback [P10E]	B504
Primera Hatchback [P11E]	B504
Primera Hatchback [P12E]	B505
Primera [P11E]	B506
Primera [P12E]	B506
Primera Sedan [P10E]	B507



pt

Vista geral
do conteúdo
(continuação)

	
Primera Sedan [P11E]	B508
Primera Wagon [P12E]	B508
Primera Wagon [WP11E]	B509
Primera Wagon [W10]	B510
Pulsar	B510
Pulsar Hatchback [N14]	B510
Pulsar Hatchback [N15]	B510
Pulsar [N14]	B511
Pulsar [N16]	B511
Pulsar Sedan [N15]	B511
Qashqai [J10]	B511
Qashqai [J11E]	B512
Qashqai+2 [JJ10]	B513
Safari	B513
Sentra	B513
Serena [C23M]	B513
Sunny	B513
Sunny Hatchback [N14]	B514
Sunny Neo [N16]	B514
Sunny Sedan [N14]	B514
Teana	B514
Teana [J31]	B515
Teana [J32]	B515
Teana [J32R]	B515
Terrano II [R20]	B515
Trade	B516
Urvan [E24]	B516
Vanette [C23]	B516
Vanette [C220]	B517
Xterra [N50]	B517
X-Trail	B517
X-Trail [T30]	B517
X-Trail [T31]	B519
X-Trail [T31R]	B519
X-Trail [T32R]	B519
100 NX [B13]	B520
300 ZX [Z32]	B520
350 Z Cabriolet [Z33]	B520
350 Z Coupé [Z33]	B520
350 Z [Z33]	B520
370 Z Coupé [Z34]	B521
370 Z Roadster [Z34]	B521
370Z Coupé [Z34]	B521
OPEL	
Adam	B521
Agila [A]	B522
Agila [B]	B522
Antara	B523
Arena	B523
Astra Cabrio [F]	B523
Astra Cabrio [G]	B523
Astra Caravan [F]	B525
Astra Caravan [G]	B525
Astra Caravan [H]	B528

cs

Přehled obsahu
(pokračování)

	
Astra Classic Caravan [F]	B530
Astra Classic [F]	B530
Astra Coupé [G]	B530
Astra [F]	B531
Astra [G]	B532
Astra GTC [H]	B535
Astra GTC [J]	B538
Astra [H]	B538
Astra [J]	B541
Astra Limousine [J]	B541
Astra Sporte Tourer [J]	B541
Astra Sports Tourer [J]	B541
Astra TwinTop [H]	B541
Calibra	B543
Campo Pick-Up [TF0]	B543
Combo	B544
Combo [Tour]	B544
Corsa	B545
Corsa [A]	B546
Corsa [B]	B546
Corsa [C]	B547
Corsa [D]	B549
Corsa [E]	B554
Frontera [A]	B554
Insignia Sports Tourer [35]	B555
Insignia [68]	B555
Insignia [69]	B555
Meriva [A]	B555
Meriva [B]	B557
Mokka	B557
Monterey [A]	B557
Monterey [B]	B557
Movano [A]	B557
Omega [A]	B558
Omega [B]	B559
Signum	B559
Sintra	B560
Tigra [A]	B560
Tigra TwinTop [B]	B560
Vectra [A]	B561
Vectra [B]	B563
Vectra [C]	B564
Vectra Caravan [B]	B565
Vectra Caravan [C]	B566
Vivaro	B567
Zafira [A]	B568
Zafira [B]	B569
PEUGEOT	
Boxer	B569
Boxer [U3]	B569
Boxer [U5]	B571
Boxer [U9]	B572
Expert [G9]	B572
Expert [U64]	B572

ru

Оглавление
(продолжение)



P 4	B574
Partner	B574
Partner [B9]	B574
Partner [M4]	B574
Partner [M5]	B576
Ranch [M4]	B577
RCZ R [T75]	B578
RCZ [T75]	B578
106 [S1]	B578
106 [S2]	B580
107 [B0]	B581
108 [B3]	B581
205	B581
205 Pickup	B583
206	B583
206 CC [T1]	B584
206 Sedan [T1]	B584
206 SW	B584
206 SW [T1]	B584
206 [T1]	B584
206+ [T3E]	B585
208	B586
301 [M3]	B586
306	B586
306 Break [N5]	B586
306 Cabriolet [N3]	B588
306 Cabriolet [N5]	B588
306 [N3]	B589
306 [N5]	B591
307 Break/SW [T5]	B593
307 Break/SW [T6]	B594
307 CC [T5]	B595
307 CC [T6]	B595
307 Sedan [T6]	B596
307 [T5]	B596
307 [T6]	B598
308 CC [T7]	B599
308 SW [T7]	B599
308 [T7]	B601
405 Break [4]	B602
405 [4]	B603
405 [15]	B604
406 Break [D8]	B605
406 Break [D9]	B606
406 Coupé [D8]	B607
406 Coupé [D9]	B607
406 [D8]	B608
406 [D9]	B609
407 Coupé [D2]	B611
407 [D2]	B611
407 SW [D2]	B611
508 RXH SW [W2]	B611
508 SW [W2]	B611
508 [W2]	B612
605 [Y30]	B612



607 [Z8]	B613
607 [Z9]	B614
806 [U60]	B614
807 [V2]	B615
1007 [A8]	B616
2008 [A94]	B616
3008 [T8]	B616
5008 [T8]	B616
PORSCHE	
Boxster [986]	B617
Boxster [987]	B617
Cayman [987C]	B617
911 Cabriolet [996]	B617
911 Cabriolet [997]	B618
911 Carrera Cabriolet [996]	B618
911 Speedster [997]	B618
911 Targa [993]	B618
911 Targa [996]	B619
911 Targa [997]	B619
911 [993]	B619
911 [996]	B619
911 [997]	B620
918 Spyder [918]	B620
928	B620
968	B620
PROTON	
Arena Pickup	B621
GEN2	B621
Savvy [BT2]	B621
Waja [CF1]	B621
Waja [CF2]	B621
Wira Aeroback	B621
RENAULT	
Alpine [D503]	B621
Avantime [XEO]	B622
B	B622
Clio I	B622
Clio I [X57]	B622
Clio II	B624
Clio II [BB/CB/SB]	B625
Clio II [BB07]	B628
Clio II [CB01]	B628
Clio II Sedan	B628
Clio III [BR/CR]	B629
Clio III Grandtour [KR]	B629
Duster [HS]	B630
Espace II [J63]	B630
Espace III [JEO]	B631
Espace IV [JK]	B631
Express, Extra, Rapid [F40]	B631
Fluence [L3]	B632
Grand Scenic II [JM]	B633



Grand Scenic III [JZ]	B634
Kangoo I	B634
Kangoo I [FC./KC.]	B634
Kangoo II [Fase II]	B637
Kangoo II [FW/KW]	B637
Koleos [HY]	B637
Laguna I [B56]	B638
Laguna I Grandtour [A56]	B639
Laguna I Grandtour [K56]	B639
Laguna I Grandtour [S56]	B641
Laguna I [556]	B641
Laguna II [BG.]	B641
Laguna II Grandtour [KG.]	B641
Laguna III [BT]	B642
Laguna III Coupé [DT]	B642
Laguna III Grandtour [KT]	B642
Logan [LS]	B643
Logan MCV [KS/FS]	B643
Mascott	B643
Master [ADCU]	B644
Master I	B644
Master II	B645
Megane	B647
Megane [BA10]	B647
Megane I Cabrio [X64]	B647
Megane I Classic [X64]	B649
Megane I Coupé [X64]	B653
Megane I Grandtour [X64]	B655
Megane I [X64]	B656
Megane II Cabrio [EM]	B660
Megane II Grandtour	B661
Megane II Grandtour [KM.]	B661
Megane II Hatchback	B662
[BM./CM./GM./SM.]	
Megane II [LM]	B664
Megane III CC [EZ]	B664
Megane III Coupé [DZ]	B665
Megane III Grandtour [KZ]	B665
Megane III Hatchback [BZ]	B665
Megane [L/BA00]	B665
Modus [FP/JP]	B665
Safrane [B54]	B666
Sandero [BS]	B668
Scenic [Fase I]	B668
Scenic I [JA]	B668
Scenic I [JM]	B671
Scenic III [JZ]	B671
Sport Spider	B672
Thalia [LB]	B672
Thalia [LU]	B673
Trafic	B674
Trafic II [EL/FL/JL]	B674
Twingo I [CO./SO.]	B675
Twingo II [CN/GN]	B675
Wind [E4]	B676



5	B676
9 [L42]	B677
11 [B37]	B677
19 Cabrio [X53]	B677
19 [X53]	B677
21 [L48]	B678
21 Nevada [K48]	B679
ROLLS-ROYCE	
Ghost [RR4]	B679
Phantom Coupé [RR3]	B679
Phantom Drophead [RR2]	B679
Phantom [RR1]	B680
Phantom VI	B680
Wraith [RR5]	B680
ROVER	
Mini	B680
Mini Cabrio	B680
Mini Cooper	B681
Mini Cooper Cabrio	B681
Mini De Ville	B681
Mini De Ville Cabrio	B681
Mini Margrave	B681
Mini Retro Rally	B682
Serie 200	B682
Serie 400	B684
Serie 400 Coupé	B686
Serie 400 Tourer	B686
Serie 600	B687
Serie 800	B687
25	B688
45	B688
75	B689
75 Tourer	B689
100 Metro	B689
100 Metro Cabrio	B690
SAAB	
9-3 Cabriolet [9400]	B690
9-3 Cabriolet [9440]	B690
9-3 Coupé [9400]	B690
9-3 Kombi [9440]	B691
9-3 [9400]	B691
9-3 [9440]	B691
9-3X [9440]	B692
9-5 Kombi [9600]	B692
9-5 [9600]	B694
900 II	B695
900 II Cabriolet	B696
900 II Coupé	B696
SANTANA	
Land Rover	B696

nl

Inhoudsopgave
(vervolg)

sv

Innehållsöversikt
(fortsättning)

pt

Vista geral
do conteúdo
(continuação)

cs

Přehled obsahu
(pokračování)

ru

Оглавление
(продолжение)

SEAT

Alhambra [7V8]	B696
Alhambra [7V9]	B697
Alhambra [710]	B697
Altea Freetrack [5P5, 5P8]	B697
Altea Freetrack [5P5/5P8]	B697
Altea XL [5P5]	B698
Altea [5P1]	B699
Arosa [6H1]	B700
Cordoba Vario [6K5]	B701
Cordoba [6K2]	B703
Cordoba [6L2]	B706
Exeo ST [3R5]	B710
Exeo [3R2]	B710
Ibiza SC [6J1]	B711
Ibiza ST [6J8]	B712
Ibiza [6J5]	B712
Ibiza [6K1]	B712
Ibiza [6L1]	B716
Inca [6K9]	B722
Leon Cupra R [1M1]	B722
Leon Cupra SC [5F5]	B723
Leon Cupra [1M1]	B723
Leon Cupra [1P1]	B723
Leon Cupra [5F1]	B723
Leon SC [5F5]	B723
Leon ST Cupra [5F8]	B723
Leon ST [5F8]	B724
Leon [1M1]	B724
Leon [1P1]	B726
Leon [5F1]	B726
Marbella	B727
Terra	B727
Toledo [KG3]	B727
Toledo [1L2]	B727
Toledo [1M2]	B728
Toledo [5P2]	B729

SKODA

Fabia Combi [NJ5]	B730
Fabia Combi [5J5]	B730
Fabia Combi [6Y5]	B731
Fabia [NJ3]	B733
Fabia RS [5J2]	B734
Fabia Schrägheck [6Y2]	B734
Fabia [5J2]	B736
Fabia [6Y3]	B738
Favorit	B740
Felicia Combi [6U5]	B740
Felicia Fun [6UF]	B740
Felicia [6U1]	B740
Forman	B740
Octavia Combi	B740
Octavia Combi [1U5]	B740



Octavia Combi [1Z5]	B742
Octavia Combi [5E5]	B743
Octavia RS Combi [5E5]	B743
Octavia [1U2]	B743
Octavia [1Z3]	B745
Octavia [5E3]	B746
Pick-Up [6U7]	B746
Praktik [5J7]	B746
Rapid [NA2]	B747
Rapid [NH3]	B747
Rapid Spaceback [NH1]	B747
Roomster [5J7]	B747
Superb Combi [3T5]	B749
Superb [3T4]	B749
Superb [3U4]	B749
Superb [3V3]	B750
Yeti	B750
Yeti [5L7]	B750

SMART (MCC)

Forfour [454]	B751
Fortwo Cabrio [450]	B751
Fortwo Cabrio [451]	B751
Fortwo Coupé [450]	B751
Fortwo Coupé [451]	B751
Fortwo ED Cabrio [451]	B751
Fortwo ED Coupé [451]	B751
Roadster Coupé [452]	B752
Roadster [452]	B752
Smart Cabrio [450]	B752
Smart Coupé [450]	B752
Smart Crossblade [450]	B752
SSANGYONG	B752
Istana	B752
Istana [L]	B752
Korando [KJ]	B753
Musso [MJ]	B753
Rexton	B754

STEYR
(STEYR-DAIMLER-PUCH AG)

G	B754
---	------

SUBARU

Forester [SF]	B754
Forester [SG]	B754
Forester [S12]	B755
Forester [S13]	B755
Impreza [G12]	B755
Impreza [G23]	B755
Impreza Kombi [GD, GG]	B755
Impreza Outback [GD, GG]	B756
Impreza Sedan [GD, GG]	B756
Impreza Sedan [G12]	B756
Impreza Sedan [G13]	B756



Impreza STI Sedan [GD, GG]	B756
Impreza WRX STI [G22]	B757
Impreza WRX STI Hatchback [G22]	B757
Impreza WRX Wagon [G22]	B757
Legacy [BL/BP]	B757
Legacy Kombi [BE/BH]	B757
Legacy Kombi [BL/BP]	B758
Legacy Outback [BE/BH]	B758
Legacy Outback [BL/BP]	B758
XV [G33]	B758

SUZUKI

Alto Hatchback [AMF]	B759
Baleno Hatchback	B759
Baleno Sedan	B759
Baleno Wagon	B759
Cappuccino	B760
Carry [ED]	B760
Carry Van [ED]	B760
Escudo	B760
Grand Vitara	B760
Grand Vitara Cabrio	B761
Ignis Hatchback	B761
Jimny [FJ]	B761
Liana Hatchback	B761
Liana Sedan	B761
Samurai	B762
Samurai Cabrio	B762
Splash [A5B]	B762
Swift Cabrio [EA]	B762
Swift Hatchback [EA]	B763
Swift Hatchback [FZ/NZ]	B763
Swift Hatchback [MA]	B763
Swift Hatchback [MZ/EZ]	B763
Swift [MA]	B764
Swift Sedan [EA]	B764
SX4	B764
SX4 Hatchback	B764
SX4 S-Cross	B765
Vitara Cabrio [ET]	B765
Vitara Cabrio [OS]	B765
Vitara [ET]	B766
Wagon R+ [EM]	B766
Wagon R+ [MM]	B766
X-90	B766

TESLA MOTORS

Model S	B766
---------	------

TOYOTA

Auris [E15]	B767
Auris [E15, JTN]	B767
Auris [E15, NMT, SB1]	B768
Auris [E18]	B769



Auris Touring Sports [E18]	B770
Avalon	B770
Avensis Liftback [T22]	B770
Avensis Liftback [T25]	B771
Avensis [T22]	B772
Avensis [T25]	B772
Avensis [T27]	B774
Avensis Verso [M2]	B775
Avensis Wagon [T22]	B775
Avensis Wagon [T25]	B775
Avensis Wagon [T27]	B777
Aygo	B777
Aygo [B4]	B778
Camry	B778
Camry Sedan	B778
Camry [V1]	B778
Camry [V2]	B779
Camry [V3]	B779
Camry [V4]	B779
Camry [V5]	B780
Camry [V40]	B780
Camry Wagon [V1]	B780
Camry [XV30]	B781
Carina E Liftback [T19]	B781
Carina E Sedan [T19]	B781
Carina E Wagon [T19]	B782
Celica Cabrio [T20]	B783
Celica Coupé [T23]	B783
Celica Liftback [T20]	B783
Century Sedan	B783
Condor	B784
Condor Estate	B784
Corolla Altis	B784
Corolla [E9]	B784
Corolla [E10]	B784
Corolla [E11]	B784
Corolla [E12]	B785
Corolla [E14/E15]	B786
Corolla [E15]	B786
Corolla [E18]	B787
Corolla Fielder	B787
Corolla Hatchback [E10]	B787
Corolla Hatchback [E11]	B788
Corolla Hatchback [E12]	B788
Corolla Liftback [E10]	B789
Corolla Liftback [E11]	B789
Corolla RunX [E12]	B790
Corolla Sedan	B790
Corolla Sedan [E10]	B790
Corolla Sedan [E11]	B790
Corolla Sedan [E12]	B791
Corolla Verso [E12]	B791
Corolla Verso [R1]	B791
Corolla Verso [R2]	B792
Corolla Verso [R10/11]	B793

de

Inhaltsübersicht
(Fortsetzung)

en

Contents overview
(continued)

fr

Sommaire
(suite)

it

Indice
(seguito)

es

Índice
(continuación)

Corolla Verso [R11]	B793
Corolla Wagon	B793
Corolla Wagon [E10]	B793
Corolla Wagon [E11]	B794
Corolla Wagon [E12]	B794
Cressida Sedan [X8]	B795
Crown [S13]	B795
Dyna	B795
Dyna 100	B796
Dyna 100 [Y2]	B796
Dyna [150]	B796
Dyna 150	B796
Dyna 150 [Y2]	B797
Echo	B797
Estima	B797
Estima Emina	B797
Estima Lucida	B797
Fortuner	B797
Funcargo	B798
Hiace	B798
Hiace [H2]	B798
Hiace [KLH]	B798
Hiace [LXH]	B799
Hiace [RCH]	B799
Hiace Van [LH]	B800
Hiace Van [LXH]	B800
Hiace Van [ZH]	B800
Hiace Wagon [LH]	B800
Hiace Wagon [ZH]	B801
Hilux	B801
Hilux [Africa]	B801
Hilux [N5/N6]	B801
Hilux [N14/N15]	B802
Hilux [N15]	B802
Hilux [N25]	B802
Hilux [N26]	B802
Hilux [N35]	B803
Hilux Pickup	B803
Hilux Pickup [N8...13]	B803
Hilux Pickup [N14...19]	B803
Hilux [Raider]	B803
Hilux Vigo	B803
Hilux Wagon [N8...13]	B804
Innova	B804
Land Cruiser	B804
Land Cruiser [J7]	B804
Land Cruiser [J7/10]	B804
Land Cruiser [J8]	B805
Land Cruiser [J9]	B805
Land Cruiser [J10]	B806
Land Cruiser Prado [J9]	B806
Land Cruiser [105]	B806
Limo	B806
MR2 Cabrio [W3]	B806
Picnic	B807



Previa	B807
Previda	B807
Probox Van	B808
Quantum	B808
Ractis	B808
RAV4	B808
RAV4 [A1]	B808
RAV4 [A2]	B809
RAV4 [A3]	B809
RAV4 Cabrio [A1]	B809
Starlet [P8]	B809
Starlet [P9]	B809
Succeed Van	B810
Tarago	B810
Urban Cruiser [P1]	B810
Verso-S	B810
Vitz	B810
Yaris [P1]	B810
Yaris [P9]	B811
Yaris [P9, JTD]	B812
Yaris [P13, JTD]	B812
Yaris Verso [P2]	B812
4-Runner [N18]	B812

UAZ

Hunter	B813
Patriot	B813
Pickup	B813

UMM
(UNIAO METALO MECANICA)

Alter	B813
-------	------

VAUXHALL

Adam	B813
Agila [A]	B814
Agila [B]	B814
Antara	B814
Arena	B815
Astra	B815
Astra Convertible [F]	B815
Astra Convertible [G]	B815
Astra Coupé [G]	B816
Astra Estate [F]	B818
Astra Estate [G]	B818
Astra Estate [H]	B821
Astra [F]	B824
Astra [G]	B824
Astra GTC [H]	B827
Astra GTC [J]	B829
Astra [H]	B829
Astra [J]	B831
Astra Sport Tourer	B832
Astra Sports Tourer	B832
Astra Sports Tourer [J]	B832



Astra TwinTop [H]	B832
Astra Van [F]	B833
Astra Van [G]	B833
Calibra	B835
Carlton III	B835
Cavalier III	B836
Combo	B837
Combo [Tour]	B838
Corsa [B]	B839
Corsa [C]	B839
Corsa [D]	B841
Corsa [E]	B846
Frontera [A]	B846
Insignia Sports Tourer [35]	B847
Insignia [68]	B847
Insignia [69]	B847
Meriva [A]	B847
Meriva [B]	B849
Mokka	B849
Monterey [A]	B849
Monterey [B]	B849
Movano [A]	B849
Nova	B849
Omega [B]	B850
Signum	B851
Sintra	B851
Tigra [A]	B851
Tigra TwinTop [B]	B852
Vectra [B]	B852
Vectra [C]	B854
Vectra Estate [B]	B855
Vectra Estate [C]	B856
Vivaro	B857
Zafira [A]	B858
Zafira [B]	B859

VOLVO

C30 [P14]	B860
S40 I	B860
S40 II [P11]	B861
S60 I	B861
S70	B861
S80 I	B862
S90	B862
V40 I	B862
V50 [P12]	B863
V70 I	B863
V70 II	B863
V90	B864
XC70 I	B864
440	B864
460	B864
480	B864
740	B865
850	B865



850 Kombi	B865
940	B865
960	B866

VW (VOLKSWAGEN)

Beetle Cabriolet [5C7]	B867
Beetle [5C1]	B867
Bora Variant [1J6]	B867
Bora [1J2]	B868
Bora [9M2]	B870
Caddy Panel Van [2K]	B870
Caddy Pickup [9U7]	B870
Caddy [SA]	B870
Caddy [2C]	B870
Caddy [2K]	B870
Caddy [9K9]	B871
California T4 [70, 7D]	B872
California T5 [7E]	B875
California T5 [7H]	B875
California T6 [SG]	B875
Caravelle T4 [70, 7D]	B875
Caravelle T5 [7E]	B878
Caravelle T5 [7H]	B878
Caravelle T6 [SG]	B879
CC [358]	B879
Corrado [50]	B879
Crafter 30 [2E, 2F]	B879
Crafter 35 [2E, 2F]	B880
Crafter 50 [2E, 2F]	B880
e-Golf [BE1]	B880
Eos [1F7]	B880
Eos [1F8]	B881
Eurovan [70]	B881
Fox	B881
Fox [Fase I]	B882
Fox [5Z1]	B882
Gol III [5X]	B883
Gol IV	B883
Golf	B883
Golf Cabriolet [1E, 1V]	B883
Golf I Bakkie [15, 16]	B884
Golf I [15, 16]	B884
Golf I [17]	B884
Golf III	B884
Golf III Cabriolet [1E7]	B884
Golf III Variant [1H5]	B885
Golf III [1H1]	B887
Golf III [1H1/1W1]	B889
Golf III [1H4]	B890
Golf IV	B890
Golf IV Cabriolet [1E7]	B890
Golf IV Station Wagon [1J5]	B891
Golf IV Variant [1J5]	B891
Golf IV [1J1]	B892
Golf IV [9B1]	B895

nl

Inhoudsopgave
(vervolg)

sv

Innehållsöversikt
(fortsättning)

pt

Vista geral
do conteúdo
(continuação)

cs

Přehled obsahu
(pokračování)

ru

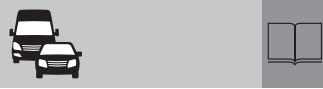
Оглавление
(продолжение)

Golf Plus [5M1]	B895
Golf Plus [521]	B896
Golf Sportsvan [AM1]	B897
Golf V Variant [1K5]	B897
Golf V [1K1]	B897
Golf VI Cabriolet [517]	B899
Golf VI Variant [AJ5]	B899
Golf VI [5K1]	B899
Golf VII Variant [BA5]	B901
Golf VII [5G1]	B901
Jetta	B901
Jetta [AV2]	B902
Jetta [AV3]	B902
Jetta III [1H8]	B902
Jetta IV [1J2]	B902
Jetta V [1K6]	B902
Jetta [1H2/1W2]	B902
Jetta [1K2]	B902
Jetta [9M2]	B903
Jetta [162]	B903
Jetta [163]	B904
Kombi	B904
LT [2D, 2H]	B904
LT [28, 29, 21]	B906
Lupo [6X1]	B907
Multivan T4 [70, 7D]	B908
Multivan T5 [7E]	B911
Multivan T5 [7H]	B911
Multivan T6 [SG]	B911
Multivan T6 [SSG]	B911
New Beetle Cabriolet [1Y7]	B911
New Beetle [1C1/9C1]	B912
Passat Alltrack [365]	B913
Passat [B5]	B914
Passat CC [357]	B914
Passat Variant [3B5]	B914
Passat Variant [3B6]	B918
Passat Variant [3C5]	B920
Passat Variant [3G5]	B920
Passat Variant [315/351/3A5]	B921
Passat Variant [365]	B922
Passat [3B2]	B922
Passat [3B3]	B927
Passat [3C2]	B929
Passat [3G2]	B930
Passat [312/351/3A2]	B930
Passat [362]	B931
Phaeton [3D]	B931
Pointer [55]	B931
Polo	B931
Polo Classic	B932
Polo Classic [6V2]	B932
Polo Classic [9V8]	B935
Polo Classic [9V8 2C4]	B935
Polo Classic [80]	B935

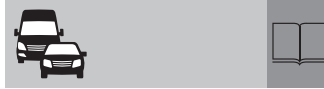

Polo Coupé [80]	B936
Polo Hatchback	B936
Polo Limousine [9N2]	B936
Polo Playa [9V4]	B936
Polo Sedan	B937
Polo Sedan [612]	B937
Polo Sedan [614]	B937
Polo Variant [6V5]	B937
Polo Vivo [6S1]	B940
Polo [6C1]	B940
Polo [6N1]	B940
Polo [6N2]	B941
Polo [6R1]	B942
Polo [9N1]	B942
Polo [9N2]	B944
Polo [9N3]	B944
Polo [9N4]	B947
Polo [80]	B947
Santana [32]	B947
Scirocco R [138]	B947
Scirocco [137]	B947
Scirocco [138]	B948
Sharan [7M8]	B948
Sharan [7M9, 7M6]	B948
Sharan [7N1]	B949
Tiguan [5N1]	B949
Tiguan [5N2]	B949
Touareg [7LA]	B949
Touareg [7L6]	B949
Touran [1T1]	B949
Touran [1T2]	B950
Touran [1T3]	B950
Touuran [1T3]	B950
Transporter T4 [70, 7D]	B950
Transporter T5 [7E]	B953
Transporter T5 [7F]	B954
Transporter T5 [7H]	B954
Transporter T5 [7J]	B954
Transporter T6 [SF]	B954
Transporter T6 [SG]	B954
Vento	B954
Vento [1H2]	B955

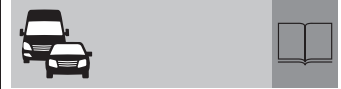

de

Hauptbrems-
zylinder

en

Master
cylinders

fr

Maîtres-cylindres
de freins

it

Pompa
freni

es

Cilindro
principal**0 204 0A2 ...**

0 204 0A2 642 RENAULT Kangoo I, Kangoo II

0 204 021 ...

0 204 021 667 NISSAN Primera, Primera Hatchback, Primera Sedan, Primera Wagon

0 204 021 712 23,81 NISSAN Almera Hatchback, Almera Sedan

0 204 022 ...

0 204 022 753 FORD Ranger

0 204 023 ...

0 204 023 075 TOYOTA Yaris
 0 204 023 105 SUZUKI Grand Vitara
 0 204 023 106 SUZUKI Grand Vitara
 0 204 023 107 SUZUKI Grand Vitara
 0 204 023 203 TOYOTA Ractis, Vitz, Yaris
 0 204 023 205 TOYOTA Ractis
 0 204 023 206 TOYOTA Yaris
 0 204 023 212 TOYOTA Estima, Previda
 0 204 023 214 TOYOTA Previda
 0 204 023 216 TOYOTA Previda
 0 204 023 218 TOYOTA Previda
 0 204 023 290 SUZUKI SX4, SX4 Hatchback
 0 204 023 292 SUZUKI SX4, SX4 Hatchback
 0 204 023 294 SUZUKI SX4, SX4 Hatchback
 0 204 023 296 SUZUKI SX4, SX4 Hatchback
 0 204 023 299 LEXUS ES
 0 204 023 300 TOYOTA Camry
 0 204 023 301 TOYOTA Camry
 0 204 023 302 TOYOTA Camry
 0 204 023 305 TOYOTA Camry
 0 204 023 340 TOYOTA Camry
 0 204 023 437 DAIHATSU Sirion II
 0 204 023 524 DAIHATSU Sirion II
 0 204 023 526 DAIHATSU Sirion II
 0 204 023 528 DAIHATSU Materia, Sirion II
 0 204 023 530 DAIHATSU Materia, Sirion II
 0 204 023 552 DAIHATSU Materia, Sirion II
 0 204 023 554 DAIHATSU Materia, Sirion II
 0 204 023 600 TOYOTA Yaris
 0 204 023 642 DAIHATSU Cuore
 0 204 023 643 INFINITI EX, FX, FX50, G, G Cabrio, G Coupé, QX70
 NISSAN 370 Z Coupé, 370 Z Roadster, 370 Z Coupé
 0 204 023 644 INFINITI EX, FX, G, G Cabrio, G Coupé, QX50, Q60 Cabrio, Q60 Coupé

0 204 023 644 NISSAN 370 Z Coupé, 370 Z Roadster, 370 Z Coupé

0 204 023 647 INFINITI EX

0 204 023 677 TOYOTA Camry

0 204 023 750 DAIHATSU Cuore

0 204 023 862 NISSAN X-Trail

0 204 023 863 NISSAN X-Trail

0 204 023 864 NISSAN X-Trail

0 204 023 865 NISSAN X-Trail

0 204 023 912 MAZDA 2

0 204 023 913 MAZDA 2

0 204 023 914 MAZDA 2

0 204 023 915 MAZDA 2

0 204 023 916 MAZDA 2

0 204 023 917 MAZDA 2

0 204 023 918 MAZDA 2

0 204 023 919 MAZDA 2

0 204 023 921 MAZDA 2

0 204 023 959 MAZDA 6, 6 Fastback, 6 Wagon

0 204 023 962 MAZDA 6, 6 Fastback, 6 Wagon

0 204 023 966 MAZDA 6, 6 Fastback, 6 Wagon

0 204 023 970 MAZDA 6, 6 Fastback, 6 Wagon

0 204 024 ...

0 204 024 097 23,81 NISSAN Almera Hatchback, Almera Sedan

0 204 024 227 20,64 SKODA Fabia, Fabia Combi, Fabia Schrägheck

0 204 032 ...

0 204 032 185 FORD Serie F

0 204 032 301 22,22 FIAT Fiorino Furgao, Palio, Palio Weekend, Siena, Strada, Tempra

0 204 032 594 FORD Serie F

0 204 032 595 VW (VOLKSWAGEN) Santana

0 204 032 600 VW (VOLKSWAGEN) Gol III, Gol IV

0 204 032 601 FIAT Fiorino Furgao, Palio, Palio Weekend, Siena, Strada, Tempra

0 204 032 602 FORD Escort, Escort Sedan, Escort SW

0 204 032 607 FORD Serie F

0 204 032 609 FIAT Albea, Fiorino, Fiorino Furgao, Palio, Palio Weekend, Siena, Strada, Tempra

0 204 032 611 FORD Serie F

nl

Hoofdrem-
cilinders

sv

Huvudbroms-
cylindrar

pt

Bomba principal
do travão



cs

Hlavní brzdové
válce

ru

Главный тормозной
цилиндр

  			
0 204 032 615		FORD	Escort, Escort Sedan, Escort SW
0 204 032 625		VW (VOLKSWAGEN)	Santana
0 204 032 656		DODGE	Caravan
0 204 032 819		FORD	Serie F
0 204 032 820		FORD	Serie F
0 204 032 823		FORD	Escort, Escort Sedan, Escort SW
0 204 032 824		FORD	Ranger
0 204 032 825		VW (VOLKSWAGEN)	Santana
0 204 032 826		VW (VOLKSWAGEN)	Santana
0 204 032 929		FORD	Escort, Escort Sedan, Escort SW
0 204 032 931		VW (VOLKSWAGEN)	Gol III, Gol IV
0 204 032 994		VW (VOLKSWAGEN)	Santana
0 204 051 ...			
0 204 051 074		NISSAN	Primera, Primera Hatchback, Primera Wagon
0 204 051 327	22,2	OPEL VAUXHALL	Agila
0 204 053 ...			
0 204 053 074		NISSAN	Teana
0 204 053 075		NISSAN	Teana
0 204 053 214		RENAULT	Koleos
0 204 053 215		RENAULT	Koleos
0 204 053 216		RENAULT	Koleos
0 204 053 217		RENAULT	Koleos
0 204 053 218		RENAULT	Koleos
0 204 053 219		RENAULT	Koleos
0 204 053 221		RENAULT	Koleos
0 204 053 254		TOYOTA	Camry
0 204 054 ...			
0 204 054 366	22,2	OPEL SUZUKI VAUXHALL	Agila Splash, Swift Hatchback Agila
0 204 054 374	22,2	SUZUKI	SX4 Hatchback
0 204 054 376	22,2	OPEL VAUXHALL	Agila Agila
0 204 054 379	22,2	SUZUKI	Splash, Swift Hatchback
0 204 054 380	22,2	SUZUKI	SX4 Hatchback
0 204 054 382	22,2	OPEL VAUXHALL	Agila Agila
0 204 054 419	22,2	SUZUKI	SX4 Hatchback
0 204 054 420	22,2	SUZUKI	SX4 Hatchback

  			
0 204 054 421	22,2	SUZUKI	SX4 Hatchback
0 204 054 487		MERCEDES-BENZ	Sprinter
0 204 054 568	22,2	SUZUKI	SX4 Hatchback
0 204 054 627	23,81	NISSAN	Qashqai
0 204 054 629	23,81	NISSAN	Qashqai
0 204 054 630	23,81	NISSAN	Qashqai
0 204 054 631	26,99	NISSAN	Cabstar
0 204 054 632	26,99	NISSAN	Cabstar
0 204 055 ...			
0 204 055 022		FIAT	Multipla
0 204 055 175		NISSAN	Almera Hatchback, Almera Sedan
0 204 055 176	23,81	NISSAN	Almera Tino
0 204 055 179		MITSUBISHI	Carisma, Carisma Hatchback
0 204 055 180		MITSUBISHI	Pajero Pinin
0 204 055 190		NISSAN	Almera Hatchback, Almera Sedan
0 204 055 191		NISSAN	Almera Hatchback, Almera Sedan
0 204 055 193	23,81	NISSAN	Almera Tino
0 204 055 389		SEAT VW (VOLKSWAGEN)	Cordoba, Cordoba Vario, Ibiza Polo Classic, Polo Variant
0 204 055 390		NISSAN	Primera, Primera Hatchback, Primera Wagon
0 204 122 ...			
0 204 122 112	19	SEAT	Marbella, Terra
0 204 122 156	22	ALFA ROMEO	Spider
0 204 122 182	20,6	ALFA ROMEO	33 Berlina, 33 Sportwagon
0 204 122 185	20,64	FIAT	Uno
0 204 122 195	22,22	FIAT LANCIA	Croma Thema Berlina, Thema Station Wagon
0 204 122 237	19,05	FIAT	Panda
0 204 122 261	19	LANCIA	Dedra Berlina
0 204 122 267	22,22	FIAT	Barchetta, Punto GT
0 204 122 268	22,22	ALFA ROMEO FIAT LANCIA	GTV, Spider, 145, 146, 155 Brava, Bravo, Marea, Marengo, Tempra, Tempra SW, Tipo Dedra Berlina
0 204 122 270	23,81	FIAT	Ducato 10, Ducato 14
0 204 123 ...			
0 204 123 072	23,8	RENAULT	Sport Spider
0 204 123 113	20,6	CITROEN	C 15
0 204 123 129	22,2	NISSAN	Primera Hatchback, Primera Sedan

de

**Hauptbrems-
zylinder**
(Fortsetzung)

en

**Master
cylinders**
(continued)

fr

**Maîtres-cylindres
de freins**
(suite)

it

**Pompa
freni**
(seguito)

es

**Cilindro
principal**
(continuación)

0 204 123 155	23,8	RENAULT	Laguna I, Laguna I Grandtour	
0 204 123 162	23,8	CITROEN	ZX	
		PEUGEOT	405	
0 204 123 172	20,6	PEUGEOT	205, 205 Pickup, 306, 306 Cabriolet	
0 204 123 176	20,6	RENAULT	Clio I, Megane, Megane I, Megane I Cabrio, Megane I Classic, Megane I Coupé, Scenic I, 19, 19 Cabrio	
0 204 123 178	20,6	RENAULT	Megane	
0 204 123 182	23,8	CITROEN	Evasion, Jumpy	
		FIAT	Scudo, Ulysse	
		LANCIA	Zeta	
		PEUGEOT	Expert, 806	
0 204 123 186	20,6	CITROEN	ZX	
0 204 123 194	25,4	FORD	Mondeo I, Mondeo I Turnier	
0 204 123 198	22,22	VOLVO	S40 I, V40 I	
0 204 123 200	22,22	MITSUBISHI	Carisma, Carisma Hatchback	
0 204 123 247	23,8	SANTANA	Land Rover	
0 204 123 314	25,4	CITROEN	Jumper	
		FIAT	Ducato 18	
		PEUGEOT	Boxer	
0 204 123 319	22,2	CITROEN	Jumper	
		FIAT	Ducato 10, Ducato 14	
		PEUGEOT	Boxer	
0 204 123 320	22,2	CITROEN	Jumper	
		FIAT	Ducato 10, Ducato 14	
		PEUGEOT	Boxer	
0 204 123 325	23,8	CITROEN	Jumper	
		FIAT	Ducato 10, Ducato 14	
		PEUGEOT	Boxer	
0 204 123 329	19	VW (VOLKSWAGEN)	Polo, Polo Classic, Polo Coupé	
0 204 123 335	23,81	MITSUBISHI	Carisma, Carisma Hatchback	
0 204 123 341	23,8	CITROEN	Berlingo	
		PEUGEOT	Partner, Ranch	
0 204 123 343	23,8	CITROEN	ZX	
		PEUGEOT	306	
0 204 123 344	23,8	PEUGEOT	306	
0 204 123 355	23,81	FORD	Transit, Transit Euroline, Transit Nugget, Transit Tourneo	
0 204 123 357	19	RENAULT	Clio I	
0 204 123 367	23,81	MERCEDES-BENZ	Serie V, Vito	
0 204 123 370	25,4	VW (VOLKSWAGEN)	LT	
0 204 123 371	22,2	RENAULT	Clio II, Kangoo I	

0 204 123 373	23,81	CITROEN	Berlingo, Xsara, Xsara Break, Xsara Coupé, Xsara Picasso	
		PEUGEOT	Partner, Ranch, 306, 306 Break	
0 204 123 402	25,4	FORD	Escort V/VI Turnier, Escort V/VI XR3i, Escort V/VI XR3i Cabrio	
0 204 123 406	23,81	AUDI	A3, TT Coupé, TT Roadster	
		SEAT	Leon, Leon Cupra, Toledo	
		SKODA	Octavia, Octavia Combi	
		VW (VOLKSWAGEN)	Bora, Bora Variant, Golf IV, Golf IV Station Wagon, Golf IV Variant, Jetta IV, New Beetle, New Beetle Cabriolet	
0 204 123 409		NISSAN	Interstar	
		OPEL	Arena, Movano	
		RENAULT	Trafic	
		VAUXHALL	Arena, Movano	
0 204 123 413		IVECO	CityClass, Daily, Scudato	
0 204 123 416	20,64	RENAULT	Clio II, Thalia	
0 204 123 462	20,6	VOLVO	440, 460, 480	
0 204 123 467	20,64	VOLVO	440, 460, 480	
0 204 123 482	25,4	FORD	Mondeo, Mondeo I, Mondeo I Turnier, Mondeo II, Mondeo II Turnier	
0 204 123 483	23,81	VW (VOLKSWAGEN)	LT	
0 204 123 484	23,81	MERCEDES-BENZ	Sprinter	
0 204 123 508		OPEL	Campo Pick-Up, Frontera, Monterey	
		VAUXHALL	Frontera, Monterey	
0 204 123 520	20,6	SEAT	Cordoba, Cordoba Vario, Ibiza	
		VW (VOLKSWAGEN)	Polo Classic, Polo Variant	
0 204 123 521	22,22	SEAT	Cordoba, Cordoba Vario, Ibiza, Inca	
		VW (VOLKSWAGEN)	Caddy, Polo Classic, Polo Variant	
0 204 123 523	22,22	ALFA ROMEO	GTV, Spider, 145, 146	
		FIAT	Bravo, Coupé, Marea	

nl

Hoofdremcilinders
(vervolg)

sv

Huvudbromscylindrar
(fortsättning)

pt



Bomba principal do travão
(continuação)

cs

Hlavní brzdové válce
(pokračování)

ru

Главный тормозной цилиндр
(продолжение)

				
0 204 123 524	22,22	FIAT	Palio, Palio Weekend, Punto, Punto Cabrio, Punto GT, Punto Van, Siena	
0 204 123 531	22,22	FIAT	Brava, Bravo, Marea	
0 204 123 532	20,6	FIAT	Punto	
0 204 123 533	22,2	FIAT	Punto	
0 204 123 537		IVECO	Daily	
0 204 123 540	20,64	OPEL	Agila	
		VAUXHALL	Agila	
0 204 123 542	20,64	VAUXHALL	Agila	
0 204 123 544	22	PEUGEOT	607	
0 204 123 545	22	PEUGEOT	607	
0 204 123 546	22	CITROEN	C5, C5 Break	
0 204 123 547		FORD	Focus	
0 204 123 548	25,4	FORD	Cougar, Mondeo, Mondeo I, Mondeo II, Mondeo II Turnier	
0 204 123 549	20,64	TOYOTA	Yaris	
0 204 123 560	20,64	TOYOTA	Yaris	
0 204 123 578	23,81	FORD	Mondeo III, Mondeo III Turnier	
0 204 123 584	22	CITROEN	C5, C5 Break	
0 204 123 586	22,2	FIAT	Stilo, Stilo Multi Wagon	
0 204 123 587	22,2	FIAT	Stilo, Stilo Multi Wagon	
0 204 123 589	22,2	NISSAN	Kubistar	
		RENAULT	Kangoo I	
0 204 123 590	20,6	RENAULT	Clio II	
0 204 123 591	23,8	JAGUAR	X-Type, X-Type Estate	
0 204 123 592	22,2	CITROEN	C8	
		FIAT	Ulysse	
		PEUGEOT	807	
0 204 123 595	23,81	CITROEN	C4, C4 Coupé, C4 Sedan	
		PEUGEOT	307, 307 Break/SW, 307 CC, 307 Sedan	
0 204 123 596	23,81	CITROEN	C4, C4 Coupé, C4 Sedan	
		PEUGEOT	307, 307 Break/SW, 307 CC, 307 Sedan	
0 204 123 597	22,2	CITROEN	C4, C4 Coupé	
		PEUGEOT	307, 307 Break/SW	
0 204 123 598	22,2	PEUGEOT	307, 307 Break/SW	
0 204 123 600	25,4	FORD	Escort VII XR3i Cabrio, Escort V/VI Turnier, Escort V/VI XR3i, Escort V/VI XR3i Cabrio	
0 204 123 605	20,6	FIAT	Punto, Punto Van	

				
0 204 123 606	22,2	FIAT	Punto, Punto Van	
0 204 123 615	25,4	CITROEN	Jumper	
0 204 123 615	25,4	FIAT	Ducato, Ducato Cargo, Ducato Minibus, Ducato 10, Ducato 11, Ducato 14, Ducato 15, Ducato 18	
		PEUGEOT	Boxer	
0 204 123 616	25,4	CITROEN	Jumper	
		FIAT	Ducato Cargo, Ducato Minibus, Ducato 10, Ducato 11, Ducato 14, Ducato 15, Ducato 18	
		PEUGEOT	Boxer	
0 204 123 620	20,6	LANCIA	Y	
0 204 123 621	20,6	ALFA ROMEO	156 Berlina, 156 Sport Wagon	
0 204 123 623	22,2	ALFA ROMEO	156 Berlina, 156 Sport Wagon, 156 Sportwagon	
0 204 123 625	22,2	FIAT	Bravo, Stilo, Stilo Multi Wagon	
0 204 123 631		TOYOTA	Avensis, Avensis Liftback, Avensis Wagon	
0 204 123 632		TOYOTA	Avensis, Avensis Liftback, Avensis Wagon	
0 204 123 634	23,8	RENAULT	Master, Master II	
0 204 123 637	23,8	OPEL	Combo, Corsa, Tigra TwinTop	
		VAUXHALL	Combo, Corsa, Tigra TwinTop	
0 204 123 639	22,2	OPEL	Combo, Corsa	
		VAUXHALL	Combo, Corsa	
0 204 123 640	22,2	OPEL	Combo, Corsa	
		VAUXHALL	Combo, Corsa	
0 204 123 643	23,8	MERCEDES-BENZ	Viano, Vito	
0 204 123 644	23,8	CITROEN	Berlingo	
		PEUGEOT	Partner	
0 204 123 645	23,8	CITROEN	Berlingo	
		PEUGEOT	Partner	
0 204 123 651	23,8	NISSAN	Interstar	
		OPEL	Arena, Movano	
		RENAULT	Master, Master II, Trafic	
		VAUXHALL	Arena, Movano	
0 204 123 652	22,2	FIAT	Idea	
0 204 123 653	22,2	CITROEN	C2, C3, C3-Pluriel	
		PEUGEOT	1007	
0 204 123 656	23,8	TOYOTA	Corolla Verso	
0 204 123 657	23,8	TOYOTA	Corolla Verso	
0 204 123 658	23,8	CITROEN	C4, C4 Coupé, C4 Sedan	

de

**Hauptbrems-
zylinder**
(Fortsetzung)

en

**Master
cylinders**
(continued)

fr

**Maîtres-cylindres
de freins**
(suite)



it

**Pompa
freni**
(seguito)

es

**Cilindro
principal**
(continuación)

				
0 204 123 605	20,6	PEUGEOT	307, 307 Break/SW, 307 CC	
0 204 123 659	22,2	HOLDEN	Barina	
		OPEL	Combo	
		VAUXHALL	Combo, Corsa	
0 204 123 662	22,2	OPEL	Combo	
		VAUXHALL	Combo	
0 204 123 663	23,8	OPEL	Meriva	
		VAUXHALL	Meriva	
0 204 123 664	23,8	OPEL	Meriva	
		VAUXHALL	Meriva	
0 204 123 666	20,6	CITROEN	C1	
		PEUGEOT	107	
		TOYOTA	Aygo	
0 204 123 667	20,6	CITROEN	C1	
		PEUGEOT	107	
		TOYOTA	Aygo	
0 204 123 668		ALFA ROMEO	GTV, Spider	
0 204 123 669	22,2	ALFA ROMEO	GTV, Spider	
0 204 123 672	22,2	FIAT	Multipla	
0 204 123 673	22,2	FIAT	Multipla	
0 204 123 676	22,2	ALFA ROMEO	156 Berlina, 156 Sport Wagon	
0 204 123 677	25,4	LDV GROUP LIMITED	Maxus	
0 204 123 678	20,6	RENAULT	Megane I, Megane I Cabrio, Megane I Classic, Megane I Coupé, Megane I Grandtour, Scenic I, Twingo I	
0 204 123 682	22,2	ALFA ROMEO	MiTo	
		FIAT	Grande Punto, Linea, Punto, Punto Evo, Punto Grande	
0 204 123 683	22,2	FIAT	Punto Grande	
0 204 123 684	23,81	ALFA ROMEO	MiTo	
0 204 123 685	22,2	ALFA ROMEO	MiTo	
		FIAT	Fiorino, Grande Punto, Punto, Punto Evo, Punto Grande, Qubo	
		ALFA ROMEO	MiTo	
0 204 123 686	22,2	ALFA ROMEO	MiTo	
		FIAT	Fiorino, Grande Punto, Punto, Punto Evo, Punto Grande, Qubo	
0 204 123 687	23,81	ALFA ROMEO	MiTo	
		FIAT	Punto, Punto Evo, Punto Grande Abarth, Punto Grande Abarth SS	
0 204 123 701	23,81	FORD	Focus, Focus I, Focus I Turnier, Focus Sedan	

				
0 204 123 705			TOYOTA	Avensis, Avensis Liftback, Avensis Wagon
0 204 123 706	23,8	TOYOTA		Corolla Verso
0 204 123 707	23,8	TOYOTA		Corolla Verso
0 204 123 709	22,2	FIAT		Punto Grande
0 204 123 711	22,2	FIAT		Doblo, Doblo Cargo
0 204 123 712	22,2	FIAT		Doblo, Doblo Cargo
0 204 123 713	23,81	FIAT		Doblo, Doblo Cargo
0 204 123 714	23,81	FIAT		Doblo, Doblo Cargo
0 204 123 716	25,4	FORD		Transit, Transit Euroline, Transit Nugget, Transit Tourneo
				Transit, Transit Euroline, Transit Nugget, Transit Tourneo
				Transit, Transit Euroline, Transit Nugget, Transit Tourneo
0 204 123 717	25,4	FORD		Transit, Transit Euroline, Transit Nugget, Transit Tourneo
				Transit, Transit Euroline, Transit Nugget, Transit Tourneo
0 204 123 718	25,4	CITROEN		Jumper
		FIAT		Ducato 11, Ducato 15, Ducato 110, Ducato 115, Ducato 130, Ducato 150, Ducato 180
		PEUGEOT		Boxer
0 204 123 719	25,4	CITROEN		Jumper
		FIAT		Ducato 11, Ducato 15, Ducato 110, Ducato 115, Ducato 130, Ducato 150, Ducato 180
		PEUGEOT		Boxer
0 204 123 720	26,9	CITROEN		Jumper
		FIAT		Ducato 17, Ducato 20, Ducato 110, Ducato 115, Ducato 130, Ducato 150, Ducato 180
		PEUGEOT		Boxer
0 204 123 721	26,9	CITROEN		Jumper
		FIAT		Ducato 17, Ducato 20, Ducato 110, Ducato 115, Ducato 130, Ducato 150, Ducato 180
		PEUGEOT		Boxer

nl

**Hoofdrem-
cilinders**
(vervolg)

sv

**Huvudbroms-
cylindrar**
(fortsättning)

pt







**Bomba principal
do travão**
(continuação)

cs

**Hlavní brzdové
válce**
(pokračování)

ru

**Главный тормозной
цилиндр**
(продолжение)

										
0 204 123 722	25,4	FIAT	Ducato 11, Ducato 15, Ducato 110, Ducato 115, Ducato 130, Ducato 150, Ducato 180	0 204 123 744	23,81	VAUXHALL	Adam, Corsa			
0 204 123 723	25,4	FIAT	Ducato 11, Ducato 15, Ducato 110, Ducato 115, Ducato 130, Ducato 150, Ducato 180	0 204 123 745	23,81	OPEL	Corsa			
0 204 123 724	26,9	FIAT	Ducato 17, Ducato 20, Ducato 110, Ducato 115, Ducato 130, Ducato 150, Ducato 180			VAUXHALL	Corsa			
0 204 123 725	26,9	FIAT	Ducato 17, Ducato 20, Ducato 110, Ducato 115, Ducato 130, Ducato 150, Ducato 180	0 204 123 746	23,81	CITROEN	C4, C4 Coupé, C4 Sedan			
0 204 123 732	31,75	IVECO	Daily	0 204 123 747	22,2	CITROEN	C2, C3			
0 204 123 733	31,75	IVECO	Daily	0 204 123 749	22,2	TOYOTA	Auris			
0 204 123 734	23,8	FIAT	Idea	0 204 123 753	22,2	TOYOTA	Auris			
0 204 123 736	23,81	CITROEN	C4, C4 Coupé, C4 Sedan	0 204 123 754	22,2	TOYOTA	Auris, Corolla			
		PEUGEOT	RCZ, 307, 307 Break/SW, 307 CC, 307 Sedan, 308, 308 CC, 308 SW	0 204 123 755	22,2	TOYOTA	Auris, Corolla			
0 204 123 737		CITROEN	C4, C4 Coupé, C4 Sedan	0 204 123 756	22,2	TOYOTA	Auris, Corolla			
		PEUGEOT	307, 307 Break/SW, 307 CC, 307 Sedan, 308, 308 CC, 308 SW	0 204 123 757		HONDA	CR-V			
0 204 123 738	22,2	OPEL	Corsa	0 204 123 758		HONDA	CR-V			
		VAUXHALL	Corsa	0 204 123 759	22,2	RENAULT	Kangoo II			
0 204 123 739	22,2	OPEL	Corsa	0 204 123 760	22,2	RENAULT	Kangoo II			
		VAUXHALL	Corsa	0 204 123 761	23,81	RENAULT	Laguna III, Laguna III Coupé, Laguna III Grandtour			
0 204 123 740	23,81	OPEL	Corsa	0 204 123 763	23,81	OPEL	Movano			
		VAUXHALL	Corsa			RENAULT	Master II			
0 204 123 741	23,81	OPEL	Corsa	0 204 123 764	22,2	FIAT	Linea			
		VAUXHALL	Corsa	0 204 123 765	23,81	FIAT	Bravo			
0 204 123 742	22,2	OPEL	Corsa			LANCIA	Delta			
		VAUXHALL	Corsa	0 204 123 766	23,81	FIAT	Bravo			
0 204 123 743	22,2	OPEL	Adam, Corsa			LANCIA	Delta			
		VAUXHALL	Adam, Corsa	0 204 123 767	22,2	FIAT	Fiorino, Qubo			
0 204 123 744	23,81	OPEL	Adam, Corsa	0 204 123 768		HONDA	CR-V			
				0 204 123 773	28,57	IVECO	Daily			
				0 204 123 775	25,4	IVECO	Daily			
				0 204 123 778	23,81	TOYOTA	Avensis, Avensis Wagon			
				0 204 123 779	23,81	TOYOTA	Avensis, Avensis Wagon			
				0 204 123 780	23,81	TOYOTA	Avensis, Avensis Wagon			
				0 204 123 781	23,81	TOYOTA	Avensis, Avensis Wagon			
				0 204 123 782	22,2	TOYOTA	Avensis, Avensis Wagon			
				0 204 123 784	22,2	FIAT	Fiorino, Qubo			
				0 204 123 785	23,81	JAGUAR	X-Type, X-Type Estate			
				0 204 123 786	20,64	CITROEN	C1			
						PEUGEOT	107			
						TOYOTA	Aygo			
				0 204 123 787	20,64	CITROEN	C1			
						PEUGEOT	107			
				0 204 123 789	20,64	FORD	B-Max, Fiesta VI, Fiesta VII, Tourneo Courier, Transit Courier			
				0 204 123 792	23,81	FIAT	Bravo			
						LANCIA	Delta			
				0 204 123 793	22	TOYOTA	Corolla Verso			
				0 204 123 794		TOYOTA	Corolla Verso			

de

**Hauptbrems-
zylinder**
(Fortsetzung)

en

**Master
cylinders**
(continued)

fr

**Maîtres-cylindres
de freins**
(suite)



it



**Pompa
freni**
(seguito)

es

**Cilindro
principal**
(continuación)



  			
0 204 123 795		TOYOTA	Corolla Verso
0 204 123 796		TOYOTA	Corolla Verso
0 204 123 797		TOYOTA	Corolla Verso
0 204 123 798	22,2	TOYOTA	Auris
0 204 123 799	22,2	TOYOTA	Auris, Corolla
0 204 123 800	22,2	TOYOTA	Auris
0 204 123 801	22,2	TOYOTA	Auris
0 204 123 802	22,2	TOYOTA	Auris
0 204 123 803	22,2	TOYOTA	Auris, Corolla
0 204 123 804	22,2	TOYOTA	Auris, Corolla
0 204 123 805		TOYOTA	Auris, Corolla
0 204 123 806	20,64	FORD	Fiesta VI, Fiesta VII
0 204 123 807	20,64	FORD	B-Max, Fiesta VI, Fiesta VII, Tourneo Courier, Transit Courier
0 204 123 809	22,2	CITROEN	C-Elysee, C3
		PEUGEOT	208, 301
0 204 123 811	22,2	CITROEN	C-Elysee, C3, DS3, DS3 Cabrio
		PEUGEOT	208, 301
0 204 123 813	23,81	CITROEN	C3
0 204 123 815	23,81	CITROEN	C3, DS3, DS3 Cabrio
		PEUGEOT	2008
0 204 123 816	23,81	FIAT	Doblo, Doblo Cargo
0 204 123 817	23,81	FIAT	Doblo, Doblo Cargo
0 204 123 818	23,81	FIAT	Doblo, Doblo Cargo
0 204 123 820	23,81	FIAT	Doblo, Doblo Cargo
0 204 123 821	23,81	FIAT	Doblo, Doblo Cargo
0 204 123 822	23,81	FIAT	Doblo, Doblo Cargo
0 204 123 823	23,81	FIAT	Doblo, Doblo Cargo
0 204 123 824	23,81	FIAT	Doblo, Doblo Cargo, 500X
		JEEP	Renegade
0 204 220 ...			
0 204 220 116	20,6	SMART (MCC)	Roadster, Roadster Coupé
0 204 255 ...			
0 204 255 049	25,4	VW (VOLKSWAGEN)	Crafter 30, Crafter 35
0 204 318 ...			
0 204 318 026		CHEVROLET	Tavera
0 204 701 ...			
0 204 701 702		RENAULT	Grand Scenic II, Megane II, Megane II Cabrio, Megane II Grandtour, Megane II Hatchback, Scenic II

  			
0 204 701 708		RENAULT	Fluence, Megane III Hatchback
0 204 701 709		RENAULT	Fluence, Megane III Hatchback
0 204 705 ...			
0 204 705 421	23,8	LANCIA	Musa
0 204 707 ...			
0 204 707 685		DODGE	Journey
0 204 709 ...			
0 204 709 703	23,81	CITROEN	C4, DS4
0 204 709 705	23,81	CITROEN	C4, DS4
0 204 712 ...			
0 204 712 040		MAHINDRA	XUV500
0 204 718 ...			
0 204 718 072		CITROEN	DS4
		PEUGEOT	RCZ, RCZ R, 308, 308 CC
0 204 720 ...			
0 204 720 432		SUZUKI	Swift Hatchback
0 204 720 433		SUZUKI	Swift Hatchback
0 204 720 435	22,2	SUZUKI	Splash, Swift Hatchback
0 204 720 437	22,2	SUZUKI	Splash, Swift Hatchback
0 204 747 ...			
0 204 747 206	20,6	LANCIA	Ypsilon
0 204 747 207	22,2	LANCIA	Ypsilon
0 204 748 ...			
0 204 748 424		MAHINDRA	Scorpio
0 204 770 ...			
0 204 770 685	22,2	LANCIA	Ypsilon
0 204 772 ...			
0 204 772 535		TOYOTA	Previda
0 204 772 538		TOYOTA	Previda
0 204 776 ...			
0 204 776 585	23,81	BMW	Serie 1, Serie 2 Cabrio, Serie 2 Coupé, Serie 3, Serie 3 GT, Serie 3 Touring, Serie 4 Cabrio, Serie 4 Coupé, Serie 4 GC

nl

Hoofdremcilinders
(vervolg)

sv

Huvudbroms-cylindrar
(fortsättning)

pt

Bomba principal do travão
(continuação)

cs

Hlavní brzdové válce
(pokračování)

ru

Главный тормозной цилиндр
(продолжение)

**0 204 779 ...**

0 204 779 135	23,81	FORD	Mondeo III, Mondeo III Turnier
----------------------	-------	------	-----------------------------------

0 204 781 ...

0 204 781 367	22,2	FIAT	500L
0 204 781 368	22,2	FIAT	500L
0 204 781 585	25,4	BMW	Serie 1, Serie 2 Cabrio, Serie 2 Coupé, Serie 3, Serie 3 GT, Serie 3 Touring, Serie 4 Cabrio, Serie 4 Coupé, Serie 4 GC
0 204 781 589	25,4	BMW	Serie 1, Serie 2 Cabrio, Serie 2 Coupé, Serie 3, Serie 3 GT, Serie 3 Touring, Serie 4 Cabrio, Serie 4 Coupé, Serie 4 GC

0 204 788 ...

0 204 788 353	20,64	FORD	Fiesta VI, Fiesta VII
0 204 788 361	23,81	FORD	Mondeo III, Mondeo III Turnier

0 204 790 ...

0 204 790 459		LEXUS	ES
----------------------	--	-------	----

0 204 793 ...

0 204 793 199	23,81	TOYOTA	Auris, Auris Touring Sports, Corolla
0 204 793 200	23,81	TOYOTA	Auris, Auris Touring Sports, Corolla
0 204 793 201	23,81	TOYOTA	Auris, Auris Touring Sports, Corolla

0 204 797 ...

0 204 797 151		SUZUKI	SX4 S-Cross
0 204 797 153		SUZUKI	SX4 S-Cross

0 204 803 ...

0 204 803 866	22,2	OPEL	Adam, Corsa
		VAUXHALL	Adam, Corsa

0 204 805 ...

0 204 805 850	22,2	FIAT	500L
0 204 805 851	22,2	FIAT	500L

**0 204 806 ...**

0 204 806 822		FIAT	500L
----------------------	--	------	------

0 204 814 ...

0 204 814 543		TOYOTA	Camry
----------------------	--	--------	-------

0 204 815 ...

0 204 815 013	26,99	ALFA ROMEO	MiTo, 4C, 4C Spider
----------------------	-------	------------	---------------------

0 204 817 ...

0 204 817 536	22,2	BMW	Serie 2 Active Tourer
		MINI (BMW)	Cooper, Cooper One, Cooper S
0 204 817 663	26,99	BMW	i 8
0 204 817 814	28,57	NISSAN	NT 500
0 204 817 815	31,75	NISSAN	NT 500
0 204 817 839		BMW	Serie 3, Serie 3 Touring, Serie 4 Cabrio, Serie 4 Coupé
0 204 817 842	26,99	BMW	Serie 3, Serie 3 Touring, Serie 4 Cabrio, Serie 4 Coupé

0 204 818 ...

0 204 818 272	25,4	FIAT	Ducato
0 204 818 273	25,4	FIAT	Ducato
0 204 818 274	25,4	FIAT	Ducato, Ducato 140
0 204 818 275	25,4	FIAT	Ducato
0 204 818 725		PORSCHE	918 Spyder

0 204 819 ...

0 204 819 790		AUDI	A3 Sportback
		VW (VOLKSWAGEN)	e-Golf, Golf VII, Passat, Passat Variant
0 204 819 792		AUDI	A3 Sportback
		VW (VOLKSWAGEN)	e-Golf, Golf VII, Passat, Passat Variant

0 204 820 ...

0 204 820 542	23,81	BMW	Serie 2 Active Tourer, Serie 2 Grand Tourer
----------------------	-------	-----	--

0 204 822 ...

0 204 822 479		OPEL	Adam, Corsa
		VAUXHALL	Adam, Corsa
0 204 822 665	20,64	CITROEN	C1
		PEUGEOT	108
		TOYOTA	Aygo
0 204 822 666	20,64	CITROEN	C1
		PEUGEOT	108
		TOYOTA	Aygo

de

**Hauptbrems-
zylinder**
(Fortsetzung)

en

**Master
cylinders**
(continued)

fr

**Maîtres-cylindres
de freins**
(suite)

it

**Pompa
freni**
(seguito)

es

**Cilindro
principal**
(continuación)

0 204 822 667	20,64		CITROEN	C1
			PEUGEOT	108
			TOYOTA	Aygo
0 204 822 668	20,64		CITROEN	C1
			PEUGEOT	108
			TOYOTA	Aygo
0 204 824 ...				
0 204 824 666			FIAT	500X
			JEEP	Renegade
0 204 830 ...				
0 204 830 141			NISSAN	Qashqai, X-Trail
0 204 830 142			NISSAN	Qashqai, X-Trail
0 986 AB8 ...				
0 986 AB8 512			PROTON	GEN2, Waja
0 986 AB8 516			PROTON	Savvy
0 986 AB8 517	20,64		TOYOTA	Fortuner, Hilux
0 986 AB8 520	23,81		HONDA	CR-V
0 986 AB8 540	20,64		TOYOTA	Corolla Wagon
0 986 AB8 545	22,23		TOYOTA	Camry
0 986 BB3 ...				
0 986 BB3 250	22,22		FORD	Fiesta
0 986 BB3 251	23,81		FORD	Courier, Fiesta
			CHEVROLET	Corsa Wagon
0 986 BB3 252	20,64		CHEVROLET	Corsa Wagon
0 986 BB3 254	23,81		MERCEDES-BENZ	Sprinter
0 986 BB3 255	22,22		FORD	Ka
0 986 BB3 256	20,64		FORD	Ka
0 986 480 ...				
0 986 480 010	20,64		OPEL	Vectra, Vectra Caravan
			VAUXHALL	Vectra, Vectra Estate
0 986 480 020	19,05		MERCEDES-BENZ	Serie C, Serie E, Serie E (Cabrio), Serie E (Coupé), Serie E (T-Modell)
0 986 480 059	23,81		MERCEDES-BENZ	2t, 3t
0 986 480 060	25,4		MERCEDES-BENZ	4t
0 986 480 062	25,4		MERCEDES-BENZ	2t, 3t
0 986 480 079	23,81		VW (VOLKSWAGEN)	LT
0 986 480 095	20,64		OPEL	Corsa
			VAUXHALL	Nova
0 986 480 114	20,64		OPEL	Vectra
			VAUXHALL	Cavalier III
0 986 480 115	22,22		OPEL	Vectra
			VAUXHALL	Cavalier III
0 986 480 116	20,64		OPEL	Corsa
			VAUXHALL	Nova
0 986 480 117	20,64		OPEL	Corsa
			VAUXHALL	Nova
0 986 480 126	22,2		FORD	Fiesta III

0 986 480 128	20,6		OPEL	Corsa
			VAUXHALL	Nova
0 986 480 129	22,2		OPEL	Astra, Astra Cabrio, Astra Caravan, Calibra, Vectra
			VAUXHALL	Astra, Astra Convertible, Astra Estate, Astra Van, Calibra, Cavalier III
0 986 480 130	20,6		OPEL	Astra, Astra Cabrio, Astra Caravan, Astra Classic, Astra Classic Caravan, Combo, Corsa, Tigra, Vectra
			VAUXHALL	Astra, Astra Convertible, Astra Estate, Astra Van, Cavalier III, Combo, Corsa, Tigra
0 986 480 131	22,2		OPEL	Vectra
			VAUXHALL	Cavalier III
0 986 480 132	22,2		OPEL	Astra, Astra Classic, Astra Classic Caravan, Vectra
			VAUXHALL	Astra, Astra Convertible, Astra Estate, Astra Van, Cavalier III
0 986 480 133	23,8		OPEL	Omega
			VAUXHALL	Omega
0 986 480 134	25,4		OPEL	Omega
			VAUXHALL	Omega
0 986 480 351	22,22		MERCEDES-BENZ	Serie C, Serie 190
0 986 480 422	17,46		VW (VOLKSWAGEN)	Polo, Polo Classic, Polo Coupé
0 986 480 430	20,64		VW (VOLKSWAGEN)	Fox, Golf I, Golf I Bakkie
0 986 480 483	20,64		OPEL	Corsa
			VAUXHALL	Nova
0 986 480 493	20,64		OPEL	Vectra, Vectra Caravan
			VAUXHALL	Vectra, Vectra Estate
0 986 480 496	20,64		OPEL	Corsa
			VAUXHALL	Nova
0 986 480 597	25,4		BMW	Serie 7
0 986 480 598	25,4		BMW	Serie 5, Serie 5 Touring, Serie 7
			BMW	Serie 3 Touring
0 986 480 599	22,2		BMW	Serie 3, Serie 3 Compact
0 986 480 600	23,81		BMW	Serie 3, Serie 3 Compact
0 986 480 601	25,4		BMW	Serie 7

nl

Hoofdremcilinders
(vervolg)

sv

Huvudbromscylindrar
(fortsättning)

pt







Bomba principal do travão
(continuação)

cs

Hlavní brzdové válce
(pokračování)

ru

Главный тормозной цилиндр
(продолжение)

								
0 986 480 603	20,6	BMW	Serie Z, Serie Z Coupé, Serie 3, Serie 3 Cabrio, Serie 3 Coupé, Serie 5, Serie 5 Touring	0 986 480 679	22,2	FORD MAZDA	Fiesta IV 121	
0 986 480 604	20,6	BMW	Serie 5, Serie 5 Touring, Serie 7	0 986 480 681	22,2	TOYOTA	Corolla, Corolla Hatchback, Corolla Liftback, Corolla Sedan, Corolla Wagon	
0 986 480 605	20,6	BMW	Serie 5, Serie 5 Touring, Serie 7	0 986 480 682	22,2	SKODA VW (VOLKSWAGEN)	Felicia, Felicia Combi, Felicia Fun, Pick-Up Caddy Pickup	
0 986 480 616	20,64	OPEL VAUXHALL	Corsa Nova	0 986 480 683	22,2	SKODA	Favorit, Forman	
0 986 480 622	22,2	ROVER	Serie 200, Serie 400, Serie 400 Tourer	0 986 480 684	22,2	OPEL VAUXHALL	Vectra, Vectra Caravan Vectra, Vectra Estate	
0 986 480 625	17,5	ROVER	Mini, Mini Cabrio, Mini Cooper, Mini Cooper Cabrio, Mini De Ville, Mini De Ville Cabrio, Mini Margrave, Mini Retro Rally	0 986 480 686	23,8	NISSAN	Vanette	
0 986 480 636	22,2	RENAULT	Master I	0 986 480 687	23,8	LANCIA	Kappa Berlina, Kappa Coupé, Kappa Station Wagon	
0 986 480 640	23,8	BMW	Serie 3, Serie 3 Cabrio, Serie 3 Compact, Serie 3 Coupé, Serie 3 Touring	0 986 480 695	23,8	NISSAN	Primera Hatchback, Primera Sedan	
0 986 480 643	20,6	OPEL VAUXHALL	Omega Carlton III	0 986 480 696	23,8	HONDA	Civic Shuttle	
0 986 480 644	22,2	OPEL VAUXHALL	Omega Carlton III	0 986 480 697	23,8	FORD	Fiesta IV, Puma	
0 986 480 655	19	TOYOTA	Starlet	0 986 480 698	23,8	FORD	Fiesta IV, Fiesta IV Courier, Puma	
0 986 480 658	20,6	NISSAN	Micra	0 986 480 699	23,8	HOLDEN OPEL VAUXHALL	Astra Astra, Astra Cabrio, Astra Caravan, Astra Coupé, Zafira Astra, Astra Convertible, Astra Coupé, Astra Estate, Astra Van, Zafira	
0 986 480 660	20,6	SUZUKI	Swift, Swift Hatchback, Swift Sedan	0 986 480 700	22,2	HONDA	Concerto Hatchback, Concerto Sedan	
0 986 480 661	20,6	FORD	Fiesta III	0 986 480 701	23,8	HONDA	Accord Aerodeck	
0 986 480 662	20,6	MITSUBISHI	Colt, Lancer, Lancer Sedan	0 986 480 721	23,81	MERCEDES-BENZ	Serie E, Serie E (Cabrio), Serie E (Coupé), Serie E (T-Modell)	
0 986 480 665	20,6	TOYOTA	Corolla, Corolla Hatchback, Corolla Liftback, Corolla Sedan, Corolla Wagon	0 986 480 722	23,81	MERCEDES-BENZ	Serie C, Serie C (T-Modell), Serie SLK	
0 986 480 670	22,2	ROVER	Serie 200, Serie 400, Serie 400 Tourer	0 986 480 723	15,4	MERCEDES-BENZ	Serie E, Serie E (T-Modell), Serie SL	
0 986 480 671	22,2	ROVER	Serie 200, Serie 400, Serie 400 Tourer	0 986 480 724	19	MERCEDES-BENZ	Serie E, Serie E (T-Modell)	
0 986 480 673	22,2	MAZDA	E-Serie, Serie E	0 986 480 725	25,4	MERCEDES-BENZ	MB	
0 986 480 676	22,2	ROVER	Serie 200, Serie 400, Serie 400 Tourer	0 986 480 726	25,4	MERCEDES-BENZ	MB	
0 986 480 677	22,2	FORD	Fiesta III, Fiesta III Courier	0 986 480 729	23,8	MITSUBISHI	L 300 Van, L 300 Wagon	
0 986 480 678	22,2	FORD	Fiesta IV	0 986 480 730	22,2	MITSUBISHI	Eclipse, Galant, Galant Hatchback	

de

**Hauptbrems-
zylinder**
(Fortsetzung)

en

**Master
cylinders**
(continued)

fr

**Maîtres-cylindres
de freins**
(suite)



it

**Pompa
freni**
(seguito)

es

**Cilindro
principal**
(continuación)

				
0 986 480 733	22,2		MITSUBISHI	Lancer, Lancer Hatchback
0 986 480 734	23,8		MITSUBISHI	L 200
0 986 480 737	25,4		MITSUBISHI	Eclipse, Galant, Galant Hatchback
0 986 480 750	19		OPEL VAUXHALL	Omega Carlton III
0 986 480 751	19		OPEL VAUXHALL	Omega Carlton III
0 986 480 752	22,2		OPEL VAUXHALL	Astra, Astra Cabrio, Astra Caravan, Vectra Astra, Astra Convertible, Astra Estate, Astra Van, Cavalier III
0 986 480 756	20,6		OPEL VAUXHALL	Omega Carlton III
0 986 480 758	23,8		OPEL SAAB (SAAB AUTOMOBILE AB)	Calibra, Vectra 9-3, 9-3 Cabriolet, 9-3 Coupé, 900 II, 900 II Cabriolet, 900 II Coupé
0 986 480 774	22,2		VAUXHALL	Calibra, Cavalier III
0 986 480 774	22,2		RENAULT	Espace II, 21, 21 Nevada
0 986 480 778	20,6		SUZUKI	Vitara, Vitara Cabrio
0 986 480 780	20,6		SUZUKI	Swift Cabrio, Swift Hatchback, Swift Sedan
0 986 480 781	22,2		SUZUKI	Samurai, Samurai Cabrio
0 986 480 782	22,2		SUZUKI	Samurai, Samurai Cabrio
0 986 480 789	20,6		SUZUKI	Samurai, Samurai Cabrio
0 986 480 810	23,8		TOYOTA	Camry Sedan
0 986 480 816	20,6		VOLVO	740
0 986 480 818	22		OPEL VAUXHALL	Combo, Corsa, Tigra Combo, Corsa, Tigra
0 986 480 819			SEAT VW (VOLKSWAGEN)	Alhambra Sharan
0 986 480 820	20,6		SEAT SKODA VW (VOLKSWAGEN)	Cordoba, Ibiza Fabia, Fabia Combi, Fabia Schrägheck, Praktik, Roomster Fox, Polo, Polo Hatchback, Polo Limousine, Polo Vivo
0 986 480 825			LAND ROVER GROUP	Defender 90, Defender 110, Defender 130

				
0 986 480 827	25,4		NISSAN OPEL RENAULT VAUXHALL	Primastar Vivaro Trafic II Vivaro
0 986 480 828	25,4		NISSAN OPEL RENAULT VAUXHALL	Primastar Vivaro Trafic II Vivaro
0 986 480 829	23,8		AUDI	A6, Coupé, 80, 80 Avant, 100, 100 Avant
0 986 480 830	20,6		RENAULT	Megane, Megane I, Megane I Cabrio, Megane I Classic, Megane I Coupé
0 986 480 831	25,4		NISSAN OPEL RENAULT VAUXHALL	Primastar Vivaro Trafic II Vivaro
0 986 480 832	23,8		AUDI	Cabriolet, Coupé, 80, 80 Avant, 100, 100 Avant
0 986 480 833	23,8		AUDI	A6, A6 Avant
0 986 480 834	22,2		VW (VOLKSWAGEN)	California T4, Caravelle T4, Kombi, Multivan T4, Transporter T4
0 986 480 835	20,6		PEUGEOT	306, 306 Cabriolet
0 986 480 836	22,2		AUDI	Coupé
0 986 480 837			FIAT OPEL VAUXHALL	Croma Signum, Vectra, Vectra Caravan Signum, Vectra, Vectra Estate
0 986 480 838	22,2		AUDI	Cabriolet, Coupé, 80, 80 Avant
0 986 480 842	25,4		MITSUBISHI	Eclipse
0 986 480 844	25,4		MITSUBISHI	Space Runner, Space Wagon
0 986 480 846	25,4		OPEL VAUXHALL	Omega Omega
0 986 480 849	25,4		BMW	Serie X
0 986 480 850	20,6		SEAT SKODA VW (VOLKSWAGEN)	Cordoba, Ibiza Fabia, Fabia Combi, Fabia Schrägheck, Praktik, Roomster Polo, Polo Vivo
0 986 480 851	23,8		RENAULT	Megane, Megane I, Megane I Cabrio, Megane I Classic, Megane I Coupé, Megane I Grandtour
0 986 480 852	20,6		DACIA RENAULT	Logan, Logan MCV Logan

nl

Hoofdremcilinders
(vervolg)

sv

Huvudbromscylindrar
(fortsättning)

pt







Bomba principal do travão
(continuação)

cs

Hlavní brzdové válce
(pokračování)

ru

Главный тормозной цилиндр
(продолжение)

													
0 986 480 853				CITROEN	C-Elysee, C2, C3, C3-Pluriel, C4 Cactus, DS3			0 986 480 868	23,8	BMW	Serie 3, Serie 3 Cabrio, Serie 3 Compact, Serie 3 Coupé, Serie 3 Touring		
				HONDA	Accord Hatchback, Accord Sedan								
0 986 480 854	22,2			CITROEN	Xsara, Xsara Coupé			0 986 480 869	22	SEAT	Arosa, Cordoba, Cordoba Vario, Ibiza, Toledo		
				PEUGEOT	206, 206+, 206 CC, 206 Sedan, 206 SW, 306, 306 Cabriolet					VW (VOLKSWAGEN)	Golf III, Golf III Variant, Lupo, Polo, Polo Classic, Polo Variant		
0 986 480 856	25,4			OPEL	Astra, Astra Caravan, Astra GTC, Astra TwinTop, Zafira			0 986 480 870	22	AUDI	A3, A3 Cabriolet, A3 Sportback		
				VAUXHALL	Astra, Astra Estate, Astra GTC, Astra TwinTop, Zafira					SEAT	Altea, Altea Freetrack, Altea XL, Leon, Toledo		
0 986 480 858	25,4			ALFA ROMEO	Brera, Spider, 159 Berlina, 159 Berlina Q4, 159 Sport Wagon, 159 Sport Wagon Q4, 159 Sportwagon					SKODA	Octavia, Octavia Combi, Yeti		
				FIAT	Croma					VW (VOLKSWAGEN)	Beetle, Caddy, Caddy Panel Van, Eos, Golf Plus, Golf V, Golf V Variant, Golf VI, Golf VI Cabriolet, Golf VI Variant, Jetta, Scirocco, Scirocco R, Touran, Touuran		
				OPEL	Signum, Vectra, Vectra Caravan								
				VAUXHALL	Signum, Vectra, Vectra Estate			0 986 480 871	23,8	TOYOTA	Avensis, Avensis Liftback, Avensis Wagon		
0 986 480 859	22			OPEL	Combo, Corsa								
				VAUXHALL	Combo, Corsa			0 986 480 872	20,6	OPEL	Agila		
0 986 480 860				FORD	Maverick					SUZUKI	Wagon R+		
				NISSAN	Terrano II			0 986 480 873		ROVER	Serie 200, Serie 400 Tourer		
0 986 480 861				MITSUBISHI	L 200, L 200 Forte, Pajero, Pajero Cabrio, Pajero Sport			0 986 480 876	23,8	CITROEN	Xsara, Xsara Break, Xsara Coupé		
0 986 480 862	20,6			BOGDAN	2110, 2111, 2310			0 986 480 877	22	BMW	Serie 3, Serie 3 Cabrio, Serie 3 Compact, Serie 3 Coupé, Serie 3 Touring		
				LADA	Forma, Niva, Samara, Samara Fun, Samara Hatchback, Serie 110, Serie 111, Serie 112, Serie 115, Serie 21000								
0 986 480 863				HYUNDAI	Accent, Accent Hatchback, Excel, Pony			0 986 480 878	23,8	SEAT	Cordoba, Ibiza, Toledo		
										VW (VOLKSWAGEN)	Golf III, Golf III Cabriolet, Golf III Variant, Passat, Passat Variant, Vento		
0 986 480 864				HONDA	Civic, Civic Coupé, Civic Hatchback, Civic Sedan, Civic Sedan			0 986 480 879	22,2	CITROEN	C2, C3, C3-Pluriel		
										PEUGEOT	1007		
0 986 480 865	22,2			ALFA ROMEO	147			0 986 480 880	25,4	OPEL	Astra, Astra Caravan, Astra GTC, Astra TwinTop		
0 986 480 866	22			FIAT	Doblo, Doblo Cargo					VAUXHALL	Astra, Astra Estate, Astra GTC, Astra TwinTop		
0 986 480 867				CHEVROLET	Lanos								
				DAEWOO	Lanos, Lanos Hatchback, Nubira, Nubira Hatchback, Nubira Station Wagon								

de

**Hauptbrems-
zylinder**
(Fortsetzung)

en

**Master
cylinders**
(continued)

fr



**Maîtres-cylindres
de freins**
(suite)

it

**Pompa
freni**
(seguito)

es

**Cilindro
principal**
(continuación)

				
0 986 480 881	20,6		HONDA	Jazz
0 986 480 882	23,8		BMW	Serie 3, Serie 3 Cabrio, Serie 3 Coupé, Serie 3 Touring
0 986 480 884	23,8		OPEL VAUXHALL	Meriva Meriva
0 986 480 885	23,8		OPEL VAUXHALL	Meriva Meriva
0 986 480 886	23,8		NISSAN RENAULT	Micra, Micra CC, Note Clio III, Clio III Grandtour, Modus
0 986 480 887	20,6		NISSAN OPEL RENAULT VAUXHALL	Primastar Vivaro Trafic II Vivaro
0 986 480 888	20,6		RENAULT	Clio II
0 986 480 889	23,8		MG ROVER	ZS Serie 400, Serie 400 Coupé, Serie 400 Tourer, Serie 600, Serie 800, 45
0 986 480 890	23,81		AUDI PORSCHE VW (VOLKSWAGEN)	A4, A4 Avant, A6, A6 Avant Boxster, 911, 911 Cabriolet, 911 Targa Passat, Passat Variant
0 986 480 892	19		OPEL VAUXHALL	Omega Carlton III
0 986 480 894	20		VOLVO	S90, V90, 940, 960
0 986 480 895	19		MERCEDES-BENZ	Serie E, Serie S, Serie SL
0 986 480 896	26		MERCEDES-BENZ	Serie CL (Coupé), Serie E, Serie S, Serie S (Coupé), Serie SL
0 986 480 902	20		RENAULT	Trafic
0 986 480 906	20		PEUGEOT	405, 405 Break
0 986 480 907	22		CHEVROLET OPEL VAUXHALL	Calibra Astra, Astra Cabrio, Astra Caravan, Astra Classic, Astra Classic Caravan, Calibra, Vectra Astra, Astra Convertible, Astra Estate, Astra Van, Calibra, Cavalier III
0 986 480 908	22		RENAULT	Laguna I

				
0 986 480 911	23		AUDI	A6, A6 Avant, Cabriolet, Coupé, 80, 80 Avant, 100, 100 Avant
0 986 480 912	23		PEUGEOT	605
0 986 480 913	23		RENAULT	Trafic
0 986 480 915	25		MERCEDES-BENZ	2t, 3t
0 986 480 916	25,4		RENAULT	Trafic
0 986 480 917	26,99		MERCEDES-BENZ	4t
0 986 480 919	20,6		FORD	Ka
0 986 480 920	23,81		OPEL VAUXHALL	Vectra, Vectra Caravan Vectra, Vectra Estate
0 986 480 921	23,81		RENAULT	Avantime, Espace III
0 986 480 922	25,4		LAND ROVER GROUP	Discovery I, Range Rover I
0 986 480 923	22,2		NISSAN	Almera Hatchback, Almera Sedan
0 986 480 925	25,4		BMW	Serie 5, Serie 5 Touring, Serie 7
0 986 480 927	22,2		FORD	Ka
0 986 480 928	23,8		NISSAN	Patrol
0 986 480 929	22,2		OPEL VAUXHALL	Vectra, Vectra Caravan Vectra, Vectra Estate
0 986 480 930	23,81		FORD SEAT VW (VOLKSWAGEN)	Galaxy Alhambra California T4, Caravelle T4, Eurovan, Kombi, Multivan T4, Sharan, Transporter T4
0 986 480 931	23,81		BMW	Serie Z, Serie Z Coupé, Serie 3, Serie 3 Cabrio, Serie 3 Compact, Serie 3 Coupé, Serie 3 Touring
0 986 480 932	23,81		VOLVO	850, 850 Kombi
0 986 480 933	23,81		FORD SEAT VW (VOLKSWAGEN)	Galaxy Alhambra California T4, Caravelle T4, Eurovan, Kombi, Multivan T4, Sharan, Transporter T4
0 986 480 934			MERCEDES-BENZ	Serie C, Serie C (T-Modell), Serie E, Serie E (T-Modell)

nl

Hoofdremcilinders
(vervolg)

sv

Huvudbromscylindrar
(fortsättning)

pt



Bomba principal do travão
(continuação)



cs

Hlavní brzdové válce
(pokračování)

ru

Главный тормозной цилиндр
(продолжение)

				
0 986 480 935	25,4	AUDI	A4, A4 Avant, A6, A6 Avant, A8, S4, S4 Avant, S6, S6 Avant, S8	
		VW (VOLKSWAGEN)	Passat, Passat Variant	
0 986 480 936	22,2	MERCEDES-BENZ	Classe A, Serie A	
0 986 480 937	23,8	MERCEDES-BENZ	Serie C, Serie C (T-Modell), Serie CLK (Cabrio), Serie CLK (Coupé), Serie SLK	
0 986 480 938	22,2	HYUNDAI	Avante, Coupé, Elantra, Lantra, Lantra Kombi	
0 986 480 939	20,64	PEUGEOT	206, 206+, 206 Sedan, 206 SW, 306	
0 986 480 940	25,4	FORD	Scorpio II, Scorpio II Turnier	
0 986 480 941	20,64	ROVER	100 Metro, 100 Metro Cabrio	
0 986 480 942	23,8	OPEL	Sintra	
		VAUXHALL	Sintra	
0 986 480 943	25,4	AUDI	Coupé S2, S4, 80, 80 Avant	
0 986 480 944	25,4	OPEL	Vectra, Vectra Caravan	
		SAAB (SAAB AUTOMOBILE AB)	9-5, 9-5 Kombi	
0 986 480 945	20,6	NISSAN	Sunny Hatchback, Sunny Sedan	
0 986 480 948	25,4	ROVER	Serie 600	
0 986 480 949	23,8	TOYOTA	Carina E Liftback, Carina E Sedan, Carina E Wagon	
0 986 480 950	25,4	BMW	Serie 3, Serie 3 Cabrio, Serie 3 Coupé	
0 986 480 951		PORSCHE	968	
0 986 480 952	23,8	FORD	Maverick	
		NISSAN	Terrano II	
0 986 480 953	22,2	FIAT	Doblo, Doblo Cargo	
0 986 480 954	25,4	MERCEDES-BENZ	Serie G	
0 986 480 955	23,81	RENAULT	Laguna I, Laguna I Grandtour	
0 986 480 956	23,8	MG	MGF	
		ROVER	Serie 800	
0 986 480 957	23,8	HONDA	Accord Sedan	
		ROVER	Serie 600	
0 986 480 958	25,4	JEEP	Cherokee, Grand Cherokee	
0 986 480 959	23,8	NISSAN	Primera Wagon	

				
0 986 480 966	25,4	AUDI	A4, A4 Avant, A6, A6 Allroad, A6 Avant, A8, RS4 Avant, S4, S4 Avant, S6, S6 Avant, S8	
		VW (VOLKSWAGEN)	Passat, Passat Variant	
0 986 480 972	23,8	FORD	Fiesta III	
0 986 480 973	20,6	FORD	Fiesta III	
0 986 480 974	23,8	AUDI	A4, A4 Avant, A6, A6 Avant	
		PORSCHE	Boxster, 911, 911 Cabriolet, 911 Carrera Cabriolet, 911 Targa	
		VW (VOLKSWAGEN)	Passat, Passat Variant	
0 986 480 976	25,4	BMW	Serie X, Serie 5, Serie 5 Touring, Serie 7	
0 986 480 977	23,8	RENAULT	Megane, Megane I, Megane I Cabrio, Megane I Classic, Megane I Coupé, Megane I Grandtour, Scenic, Scenic I	
0 986 480 978	23,8	NISSAN	Micra	
0 986 480 984	20,6	RENAULT	Clio II, Clio II Sedan, Thalia	
0 986 480 986	23,8	FORD	Escort VII, Escort VII Cabrio, Escort VII Express, Escort VII Turnier, Escort VII XR3i Cabrio	
0 986 480 987	23,81	SEAT	Cordoba, Cordoba Vario, Ibiza, Inca, Toledo	
		VW (VOLKSWAGEN)	Caddy, Golf Cabriolet, Golf III, Golf III Cabriolet, Golf III Variant, Golf IV Cabriolet, Passat, Passat Variant, Polo Classic, Polo Variant, Vento	
0 986 480 988	22,2	ALFA ROMEO	GT, 147	
0 986 480 989	25,4	AUDI	A4, A4 Avant, A6, A6 Allroad, A6 Avant, RS4 Avant, S4, S4 Avant	
		VW (VOLKSWAGEN)	Passat, Passat Variant	

de

**Hauptbrems-
zylinder**
(Fortsetzung)

en

**Master
cylinders**
(continued)

fr

**Maîtres-cylindres
de freins**
(suite)

it

**Pompa
freni**
(seguito)

es

**Cilindro
principal**
(continuación)



0 986 480 990	22,2		TOYOTA	Corolla, Corolla Hatchback, Corolla Liftback, Corolla Sedan, Corolla Wagon
0 986 480 991	20,64		HYUNDAI	Atos, Atos Prime
0 986 480 992	27		VW (VOLKSWAGEN)	California T5, Caravelle T5, Multivan T5, Touareg, Transporter T5
0 986 480 993	25,4		ALFA ROMEO	Brera, Spider, 159 Berlina, 159 Berlina Q4, 159 Sport Wagon, 159 Sport Wagon Q4, 159 Sportwagon
			FIAT	Croma
			OPEL	Signum, Vectra, Vectra Caravan
			SAAB (SAAB AUTOMOBILE AB)	9-5, 9-5 Kombi
			VAUXHALL	Signum, Vectra, Vectra Estate
0 986 480 994	23,81		FORD	Focus C-MAX, Focus II, Focus II Cabriolet, Focus II Turnier
0 986 480 995	23,81		FORD	Fiesta IV Courier
0 986 480 996	22		CHEVROLET	Lanos
			DAEWOO	Lanos, Lanos Hatchback
0 986 480 997	25,4		MERCEDES-BENZ	Serie G, Sprinter
0 986 480 998	23,81		MERCEDES-BENZ	Sprinter
0 986 480 999	20,64		NISSAN	Primastar
			OPEL	Vivaro
			RENAULT	Trafic II
0 986 481 ...				
0 986 481 000	23,81		FORD	Focus I, Focus I Turnier
0 986 481 001	22,2		DACIA	Logan MCV
			RENAULT	Logan MCV
0 986 481 002	23,81		RENAULT	Grand Scenic II, Megane II, Megane II Cabrio, Megane II Grandtour, Megane II Hatchback, Scenic II
0 986 481 003	23,81		HONDA	Civic Hatchback
0 986 481 005	22,2		FIAT	Doblo, Doblo Cargo, Multipla, Punto, Punto Van

0 986 481 006	27		AUDI	A4 Cabriolet, A6, A6 Allroad, A6 Avant, RS4, RS4 Avant, RS4 Cabriolet, RS6, RS6 Avant, S4, S4 Avant, S4 Cabriolet, S6, S6 Avant
0 986 481 007	25,4		VW (VOLKSWAGEN)	California T4, Caravelle T4, Eurovan, Kombi, Multivan T4, Transporter T4
0 986 481 008	22,2		AUDI	A2
0 986 481 009	22,2		AUDI	A2
0 986 481 010			BMW	Serie 3, Serie 3 Cabrio, Serie 3 Coupé, Serie 3 Touring
0 986 481 011			BMW	Serie 3, Serie 3 Cabrio, Serie 3 Coupé, Serie 3 Touring
0 986 481 012			BMW	Serie 5, Serie 5 GT, Serie 5 Touring, Serie 6, Serie 6 Cabrio, Serie 7
			ROLLS-ROYCE	Ghost, Wraith
0 986 481 013	22,2		SEAT	Arosa
			VW (VOLKSWAGEN)	Lupo, Polo
0 986 481 014	23,81		SKODA	Felicia, Felicia Combi, Pick-Up
			VW (VOLKSWAGEN)	Caddy Pickup
0 986 481 015	23,81		SEAT	Arosa
			VW (VOLKSWAGEN)	Lupo, Polo
0 986 481 016	22,2		SEAT	Cordoba, Cordoba Vario, Ibiza, Toledo
			VW (VOLKSWAGEN)	Golf III, Golf III Variant, Polo Classic, Polo Variant, Vento
0 986 481 017	23,8		BMW	Serie Z, Serie Z Coupé, Serie 3, Serie 3 Cabrio, Serie 3 Compact, Serie 3 Coupé, Serie 3 Touring
0 986 481 019	19,05		LADA	Serie 2100, Serie 21000, Toscana

nl

**Hoofdrem-
cilinders**
(vervolg)

sv

**Huvudbroms-
cylindrar**
(fortsättning)

pt



**Bomba principal
do travão**
(continuação)



cs

**Hlavní brzdové
válce**
(pokračování)

ru

**Главный тормозной
цилиндр**
(продолжение)

			
0 986 481 020	22,2	FIAT	Albea, Fiorino, Fiorino Furgao, Palio, Palio Weekend, Siena, Strada
0 986 481 022	23,81	AUDI	S3, TT Coupé, TT Roadster
		SEAT	Leon, Leon Cupra, Toledo
		VW (VOLKSWAGEN)	Bora, Bora Variant, Golf, Golf IV, Golf IV Station Wagon, Golf IV Variant, New Beetle
0 986 481 023	20,64	TOYOTA	Yaris
0 986 481 024	25,4	VOLVO	S60 I, S80 I, V70 II, XC70 I
0 986 481 026	27	ALPINA (B. BOVENSIEPEN KG)	B7
		BMW	Serie 7
		ROLLS-ROYCE	Phantom, Phantom Coupé, Phantom Drophead
0 986 481 027	23,81	MG	ZS
		ROVER	Serie 400, Serie 400 Coupé, Serie 400 Tourer, 45
0 986 481 028	23,81	HOLDEN	Astra
		OPEL	Astra, Astra Cabrio, Astra Caravan, Astra Coupé, Zafira
		VAUXHALL	Astra, Astra Convertible, Astra Coupé, Astra Estate, Astra Van, Zafira
0 986 481 029	23,81	FORD	Escort VII, Escort VII Cabrio, Escort VII Express, Escort VII Turnier, Escort VII XR3i Cabrio
0 986 481 030	25,4	VW (VOLKSWAGEN)	California T4, Caravelle T4, Eurovan, Kombi, Multivan T4, Transporter T4
0 986 481 031	20,64	RENAULT	Twingo II
0 986 481 032	23,81	RENAULT	Laguna II, Laguna II Grandtour
0 986 481 033	23,81	RENAULT	Espace III
0 986 481 034	22,2	RENAULT	Megane I, Megane I Classic, Megane I Coupé, Megane I Grandtour
0 986 481 035	23,81	RENAULT	Megane I Grandtour, Scenic, Scenic I

			
0 986 481 036	20,64	RENAULT	Clio II, Clio II Sedan, Thalia
0 986 481 037	20,64	DAEWOO	Matiz
0 986 481 038	20,64	DAEWOO	Matiz
0 986 481 039	22,2	CHEVROLET	Lanos
		DAEWOO	Lanos, Lanos Hatchback, Nubira, Nubira Hatchback, Nubira Station Wagon
0 986 481 040	20,64	CHEVROLET	Lanos
		DAEWOO	Lanos, Lanos Hatchback
0 986 481 041	20,64	CHEVROLET	Lanos
		DAEWOO	Lanos, Lanos Hatchback
0 986 481 042	22,2	MINI (BMW)	Cooper, Cooper Cabrio, Cooper One, Cooper One Cabrio, Cooper S, John Cooper Works, John Cooper Works Cabrio
0 986 481 043	20,64	DAEWOO	Matiz
0 986 481 045	22,2	MINI (BMW)	Cooper, Cooper Cabrio, Cooper One, Cooper One Cabrio, Cooper S, John Cooper Works, John Cooper Works Cabrio
0 986 481 046	25,4	AUDI	A4, A4 Avant, A4 Cabriolet, A6, A6 Avant, S6, S6 Avant
		SEAT	Exeo, Exeo ST
		SKODA	Superb
		VW (VOLKSWAGEN)	Passat, Passat Variant
0 986 481 047		FORD	Galaxy
		SEAT	Alhambra
		VW (VOLKSWAGEN)	Sharan
0 986 481 048	23,81	MERCEDES-BENZ	Serie E, Serie E (T-Modell)
0 986 481 050	20,6	OPEL	Vivaro
		RENAULT	Trafic II
		VAUXHALL	Vivaro
0 986 481 051	20,6	OPEL	Vivaro
		RENAULT	Trafic II
	VAUXHALL	Vivaro	
0 986 481 052	20,6	OPEL	Vivaro
		VAUXHALL	Vivaro

de

**Hauptbrems-
zylinder**
(Fortsetzung)

en

**Master
cylinders**
(continued)

fr

**Maitres-cylindres
de freins**
(suite)

it

**Pompa
freni**
(seguito)

es

**Cilindro
principal**
(continuación)

0 986 481 057	23,81	RENAULT	Clio III, Clio III Grandtour, Modus	
0 986 481 058	25,4	OPEL	Astra, Astra Caravan, Astra GTC, Astra TwinTop	
		VAUXHALL	Astra, Astra Estate, Astra GTC, Astra TwinTop	
0 986 481 059	25,4	OPEL	Astra, Astra Caravan, Astra GTC, Astra TwinTop, Zafira	
		VAUXHALL	Astra, Astra Estate, Astra GTC, Astra TwinTop, Zafira	
0 986 481 060	23,8	MINI (BMW)	Cooper, Cooper Cabrio, Cooper Clubman, Cooper Clubvan, Cooper Countryman, Cooper Coupé, Cooper One, Cooper One Cabrio, Cooper One Clubman, Cooper One Countryman, Cooper Paceman, Cooper Roadster, John Cooper Works, John Cooper Works Cabrio, John Cooper Works Clubman, John Cooper Works Countryman, John Cooper Works Coupé, John Cooper Works Paceman, John Cooper Works Roadster	
0 986 481 061	23,81	FORD	Fiesta V, Fusion	
0 986 481 062	23,81	FORD	Fiesta V, Fusion	
0 986 481 063	23,81	FORD	Fiesta V, Fusion	
0 986 481 064	23,8	NISSAN	Qashqai	
0 986 481 066	22,2	FIAT	Sedici	
F 00E 520 ...				
F 00E 520 272		FIAT	Ducato	
F 00E 520 273		FIAT	Ducato, Ducato 140	
F 00E 520 274		FIAT	Ducato	
F 00E 520 275		FIAT	Ducato	
F 01G 09C ...				
F 01G 09C 0BK		HOLDEN	Jackaroo, Rodeo 4x4	

F 01G 09C 0EJ		TOYOTA	Yaris, Yaris Verso	
F 01G 09C 0LP		NISSAN	Pickup	
F 01G 09C 0M1		NISSAN	Pickup	
F 01G 09C 0M4		NISSAN	Cedric Sedan, Cedric Wagon	
F 01G 09C 0ND		NISSAN	Lancer	
F 01G 09C 0NL		NISSAN	Urvan	
F 01G 09C 0NM		NISSAN	Urvan	
F 01G 09C 0NN		NISSAN	Urvan	
F 01G 09C 0PG		NISSAN	Urvan	
F 01G 09C 0PV		NISSAN	Maxima	
F 01G 09C 0PX		NISSAN	Prairie Pro	
F 01G 09C 0RH		NISSAN	L 200	
F 01G 09C 0RJ		NISSAN	L 200	
F 01G 09C 0SB		NISSAN	Maxima	
F 01G 09C 0SK		NISSAN	Primera Hatchback, Primera Sedan	
F 01G 09C 0SP		NISSAN	Sunny Hatchback, Sunny Sedan	
F 01G 09C 0TA		NISSAN	Colt, Lancer, Lancer Sedan, Lancer Station Wagon	
F 01G 09C 0TH		NISSAN	Maxima QX	
F 01G 09C 0TN		NISSAN	Pulsar, Pulsar Hatchback, Pulsar Sedan	
F 01G 09C 0TV		NISSAN	Lancer	
F 01G 09C 0TW		NISSAN	Lancer Evo5/6	
F 01G 09C 0TX		NISSAN	Pathfinder	
F 01G 09C 0T1		NISSAN	Altima	
F 01G 09C 0T5		NISSAN	Colt, Lancer, Lancer Station Wagon	
F 01G 09C 0UB		NISSAN	Almera Hatchback	
F 01G 09C 0UN		NISSAN	Galant, Galant Station Wagon	
F 01G 09C 0UR		NISSAN	Galant, Galant Station Wagon	
F 01G 09C 0UX		NISSAN	Almera Hatchback, Almera Sedan, Pulsar, Sunny	
F 01G 09C 0U7		NISSAN	Pathfinder	
F 01G 09C 0WD		NISSAN	Maxima QX	
F 01G 09C 0WM		NISSAN	Pathfinder	
F 01G 09C 0WU		NISSAN	Lancer, Lancer Station Wagon	
F 01G 09C 0WW		NISSAN	X-Trail	
F 01G 09C 0XJ		NISSAN	Lancer, Lancer Station Wagon	
F 01G 09C 0XK		NISSAN	Lancer, Lancer Station Wagon	
F 01G 09C 0XL		NISSAN	Lancer, Lancer Station Wagon	
F 01G 09C 0YF		NISSAN	Vanette	
F 01G 09C 0YK		NISSAN	Sigma	

nl

**Hoofdrem-
cilinders**
(vervolg)

sv

**Huvudbroms-
cylindrar**
(fortsättning)

pt

**Bomba principal
do travão**
(continuação)

cs

**Hlavní brzdové
válce**
(pokračování)

ru

**Главный тормозной
цилиндр**
(продолжение)



F 01G 09C 0YY	mitsubishi	Space Runner, Space Wagon
F 01G 09C 0ZH	NISSAN	Bluebird
F 01G 09C 0ZS	NISSAN	Sunny
F 01G 09C 1AN	ISUZU	Serie N
F 01G 09C 1AZ	MAZDA	Xedos-9
F 01G 09C 1BB	ISUZU	Frontier
F 01G 09C 1BF	MAZDA	323 Astina Hatchback
F 01G 09C 1BG	MAZDA	323 Hatchback
F 01G 09C 1BN	SUZUKI	Baleno Hatchback, Baleno Sedan, Baleno Wagon
F 01G 09C 1BP	SUZUKI	Cappuccino
F 01G 09C 1B8	ISUZU	Frontier
F 01G 09C 1CA	TOYOTA	Previa
F 01G 09C 1CB	TOYOTA	Celica Coupé
F 01G 09C 1CC	TOYOTA	Celica Coupé
F 01G 09C 1CU	MAZDA	Xedos-9
F 01G 09C 1CX	MAZDA	Millenia
F 01G 09C 1C7	TOYOTA	Celica Coupé
F 01G 09C 1C8	TOYOTA	Celica Coupé
F 01G 09C 1C9	TOYOTA	Previa
F 01G 09C 1DB	TOYOTA	MR2 Cabrio
F 01G 09C 1DC	TOYOTA	MR2 Cabrio
F 01G 09C 1DD	TOYOTA	Yaris, Yaris Verso
F 01G 09C 1DK	SUZUKI	Ignis Hatchback
F 01G 09C 1D1	SUZUKI	Ignis Hatchback
F 01G 09C 1D2	CHEVROLET	Rezzo
	DAEWOO	Rezzo
F 01G 09C 1D7	TOYOTA	Corolla, Corolla Hatchback, Corolla Liftback, Corolla Wagon
F 01G 09C 1D8	TOYOTA	Corolla, Corolla Hatchback, Corolla Liftback, Corolla Wagon
F 01G 09C 1E2	TOYOTA	Echo, Yaris, Yaris Verso
F 01G 09C 1E3	TOYOTA	Yaris, Yaris Verso
F 01G 09C 1FM	NISSAN	Sunny Hatchback
F 01G 09C 1FR	SUZUKI	Baleno Sedan
F 01G 09C 1HW	NISSAN	E20
F 01G 09C 10S	mitsubishi	Galant, Galant Station Wagon
F 01G 09C 10T	mitsubishi	Galant, Galant Station Wagon
F 01G 09C 11L	NISSAN	Almera Hatchback, Almera Sedan
F 01G 09C 11U	NISSAN	Almera Hatchback, Almera Sedan
F 01G 09C 11V	NISSAN	Almera Hatchback, Almera Sedan
F 01G 09C 12C	TOYOTA	Previa
F 01G 09C 12D	TOYOTA	Previa



F 01G 09C 12E	NISSAN	Teana
F 01G 09C 12F	mitsubishi	Lancer, Lancer Station Wagon
F 01G 09C 12G	mitsubishi	Lancer, Lancer Station Wagon
F 01G 09C 12T	NISSAN	X-Trail
F 01G 09C 12U	NISSAN	X-Trail
F 01G 09C 12Y	mitsubishi	Lancer, Lancer Station Wagon
F 01G 09C 18B	HONDA	Accord, Accord Tourer
F 01G 09C 18C	HONDA	Accord, Accord Tourer
F 01G 09C 18D	HONDA	Accord, Accord Tourer
F 01G 09C 18E	HONDA	Accord, Accord Tourer
F 01G 09C 18U	NISSAN	350 Z
F 01G 09C 19A	HONDA	Accord, Accord Tourer
F 01G 09C 19B	HONDA	Accord, Accord Tourer
F 01G 09C 19C	HONDA	Accord, Accord Tourer
F 01G 09C 19D	HONDA	Accord
F 01G 09C 100	mitsubishi	Lancer Evo5/6
F 01G 09C 105	NISSAN	Almera Hatchback, Almera Sedan
F 01G 09C 107	NISSAN	Hardbody
F 01G 09C 109	NISSAN	Hardbody, Pickup
F 01G 09C 115	SUZUKI	Wagon R+
F 01G 09C 121	mitsubishi	Pajero IO, Pajero Pinin
F 01G 09C 122	mitsubishi	Pajero Pinin
F 01G 09C 131	NISSAN	Teana
F 01G 09C 138	ISUZU	Serie N
F 01G 09C 190	HONDA	Accord, Accord Tourer
F 01G 09C 191	HONDA	Accord, Accord Tourer
F 01G 09C 192	HONDA	Accord, Accord Tourer
F 01G 19B ...		
F 01G 19B 0HP	DAEWOO	Leganza
F 01G 19B 0HR	DAEWOO	Leganza
F 01G 19B 0HS	DAEWOO	Leganza
F 01G 19B 0HT	CHEVROLET	Evanda
F 01G 19B 0HU	CHEVROLET	Evanda
	DAEWOO	Evanda
F 01G 19B 0HV	CHEVROLET	Evanda
	DAEWOO	Evanda
F 01G 19B 0JB	CHEVROLET	Rezzo
	DAEWOO	Rezzo
F 01G 19C ...		
F 01G 19C 02T	ISUZU	Serie N
F 01G 19C 02X	mitsubishi	Lancer Evo7, Lancer Evo8, Lancer Evo9
F 01G 19C 02Y	mitsubishi	Lancer Evo7, Lancer Evo8, Lancer Evo9
F 01G 19C 031	mitsubishi	Lancer Evo7
F 01G 19C 032	mitsubishi	Lancer Evo7

de

**Hauptbrems-
zylinder**
(Fortsetzung)

en

**Master
cylinders**
(continued)

fr

**Maîtres-cylindres
de freins**
(suite)

it

**Pompa
freni**
(seguito)

es

**Cilindro
principal**
(continuación)



F 01G 29L ...

F 01G 29L 01N	ISUZU	Serie N
----------------------	-------	---------

F 01G 062 ...

F 01G 062 0AA	NISSAN	Almera, Sunny Neo
F 01G 062 0AE	NISSAN	Pulsar
F 01G 062 0AF	NISSAN	AD Van
F 01G 062 0AG	MITSUBISHI	Lancer, Lancer Station Wagon
F 01G 062 0AM	MITSUBISHI	Outlander
F 01G 062 0AO	NISSAN	Cabstar ZZ
F 01G 062 0A4	NISSAN	Almera Hatchback, Almera Sedan
F 01G 062 0BK	NISSAN	Pickup
F 01G 062 00G	TOYOTA	Yaris, Yaris Verso
F 01G 062 00J	TOYOTA	Funcargo, Yaris Verso
F 01G 062 00S	SUZUKI	Ignis Hatchback
F 01G 062 01N	TOYOTA	Quantum
F 01G 062 01P	TOYOTA	Hiace
F 01G 062 01X	TOYOTA	Celica Coupé
F 01G 062 01Y	TOYOTA	Celica Coupé
F 01G 062 02R	MITSUBISHI	L 200, Pajero Sport
F 01G 062 06J	NISSAN	Teana
F 01G 062 07H	NISSAN	X-Trail
F 01G 062 07J	NISSAN	X-Trail
F 01G 062 07K	NISSAN	X-Trail
F 01G 062 07L	NISSAN	X-Trail
F 01G 062 09D	NISSAN	350 Z Cabriolet
F 01G 062 021	TOYOTA	Celica Coupé
F 01G 062 022	TOYOTA	Celica Coupé
F 01G 062 025	TOYOTA	Yaris, Yaris Verso
F 01G 062 030	TOYOTA	Dyna
F 01G 062 051	DAIHATSU	Copen
F 01G 062 084	NISSAN	Pickup
F 01G 062 085	NISSAN	Pickup
F 01G 062 086	NISSAN	Pickup
F 01G 062 087	NISSAN	Hardbody, NP300, Pickup
F 01G 062 088	NISSAN	Pickup
F 01G 062 089	NISSAN	Pickup
F 01G 062 091	NISSAN	Almera Hatchback, Almera Sedan, Pulsar
F 01G 062 097	MITSUBISHI	Lancer

F 01G 160 ...

F 01G 160 05F	CHEVROLET	Evanda
F 01G 160 06D	CHEVROLET	Evanda
F 01G 160 06E	CHEVROLET	Evanda
F 01G 160 028	CHEVROLET	Evanda
	DAEWOO	Evanda

F 026 A01 ...

F 026 A01 541	FORD	Econovan
	MAZDA	Marathon

F 026 A01 554	TOYOTA	Hilux
F 026 A01 558	FORD	Courier
F 026 A01 578	MITSUBISHI	Triton
F 026 A01 583	NISSAN	Patrol GR
F 026 A01 584	NISSAN	Patrol GR
F 026 A01 592	MAZDA	121
F 026 A01 593	MAZDA	MX-6, 626, 626 Hatchback
F 026 A01 594	MAZDA	MX-6, 626, 626 Hatchback
F 026 A01 595	MAZDA	121 METRO Wagon
F 026 A01 599	MAZDA	MX-6, 626, 626 Hatchback
F 026 A01 601	SUZUKI	Vitara, Vitara Cabrio
F 026 A01 602	TOYOTA	Land Cruiser
F 026 A01 606	TOYOTA	Land Cruiser
F 026 A01 617	DAIHATSU	Charade
F 026 A01 619	DAIHATSU	Delta
F 026 A01 622	HYUNDAI	Elantra, Lantra
F 026 A01 623	HYUNDAI	Elantra, Lantra
F 026 A01 632	MITSUBISHI	Canter 35
F 026 A01 637	TOYOTA	Corolla Wagon
F 026 A01 638	TOYOTA	Land Cruiser
F 026 A01 642	TOYOTA	Dyna
F 026 A01 644	TOYOTA	Tarago
F 026 A01 645	TOYOTA	Hilux Pickup, Hilux Wagon
F 026 A01 646	TOYOTA	Hilux Pickup
F 026 A01 649	TOYOTA	Hiace Van, Hiace Wagon
F 026 A01 651	NISSAN	Maxima
F 026 A01 653	MAZDA	323, 323 Astina Hatchback, 323 Hatchback, 323 Sedan
F 026 A01 657	DAEWOO	Nexia, Nexia Hatchback
F 026 A01 658	MITSUBISHI	Space Runner, Space Wagon
F 026 A01 660	MITSUBISHI	Lancer, Lancer Evo4, Lancer Sedan, Mirage
F 026 A01 661	NISSAN	Pulsar
F 026 A01 662	NISSAN	Pulsar
F 026 A01 663	MAZDA	323 Astina Hatchback
F 026 A01 664	NISSAN	Pathfinder
F 026 A01 666	NISSAN	Pathfinder
F 026 A01 668	TOYOTA	Celica Cabrio, Celica Liftback
F 026 A01 669	TOYOTA	Land Cruiser
F 026 A01 670	TOYOTA	RAV4, RAV4 Cabrio
F 026 A01 671	TOYOTA	Hilux Pickup
F 026 A01 672	TOYOTA	Hilux Pickup, Hilux Wagon
F 026 A01 676	FORD	Econovan

nl

Hoofdremcilinders
(vervolg)

sv

Huvudbromscylindrar
(fortsättning)

pt



Bomba principal do travão
(continuação)



cs

Hlavní brzdové válce
(pokračování)

ru

Главный тормозной цилиндр
(продолжение)

				
F 026 A01 678				HONDA Civic CRX, Civic Hatchback, Civic Sedan
F 026 A01 680				MITSUBISHI Express, L 300 Van, L 300 Wagon
F 026 A01 681				MITSUBISHI Express, L 300 Van
F 026 A01 683				FORD Econovan
				MAZDA Marathon
F 026 A01 684				MAZDA 323
F 026 A01 689				NISSAN Pulsar
F 026 A01 691				NISSAN Pulsar Hatchback
F 026 A01 692				MITSUBISHI Lancer
F 026 A01 693				MITSUBISHI Lancer
				PROTON Arena Pickup, Wira Aeroback
F 026 A01 695				MITSUBISHI Galant, Galant Hatchback, Lancer
F 026 A01 696				MITSUBISHI Pajero
F 026 A01 702				TOYOTA Dyna 100
F 026 A01 707				TOYOTA Avalon, Camry, Camry Sedan
F 026 A01 708				TOYOTA Avalon
F 026 A01 710				TOYOTA Hilux, Land Cruiser, Land Cruiser Prado
F 026 A01 711				TOYOTA Hilux, Hilux Pickup
F 026 A01 712				FORD Courier
F 026 A01 713				FORD Courier
F 026 A01 714				TOYOTA Hilux, Land Cruiser, Land Cruiser Prado
F 026 A01 715				MAZDA 626, 626 Hatchback
F 026 A01 716				MAZDA 626, 626 Hatchback
F 026 A01 718				NISSAN Pulsar, Pulsar Hatchback, Pulsar Sedan
F 026 A01 720				MITSUBISHI L 200, L 200 Forte, Pajero, Pajero Cabrio, Pajero Sport
F 026 A01 721				NISSAN Patrol GR
F 026 A01 722				NISSAN Patrol GR
F 026 A01 727				MAZDA 323 Hatchback
F 026 A01 728				MAZDA 323, 323 Hatchback
F 026 A01 730				TOYOTA Corolla, Corolla Altis, Corolla Wagon
F 026 A01 731				HONDA City
F 026 A01 733				HOLDEN Barina
F 026 A01 734				SUBARU Forester, Impreza Kombi, Impreza Outback, Impreza Sedan, Impreza STI Sedan, Legacy Kombi
F 026 A01 739				NISSAN AD Van, Pulsar
F 026 A01 745				NISSAN Pickup
F 026 A01 746				NISSAN Pickup
F 026 A01 747				NISSAN Maxima QX

				
F 026 A01 750				DAIHATSU YRV
F 026 A01 754				FORD Explorer, Ranger
F 026 A01 759				MAZDA Serie E
F 026 A01 764				HYUNDAI Accent, Accent Hatchback, Verna
F 026 A01 765				HYUNDAI Accent, Accent Hatchback, Verna
F 026 A01 766				MITSUBISHI Express, L 400, Space Gear
F 026 A01 767				MITSUBISHI Express, L 400, Space Gear
F 026 A01 768				HYUNDAI Elantra, Elantra Hatchback
F 026 A01 769				HYUNDAI Elantra, Elantra Hatchback
F 026 A01 770				HYUNDAI Accent, Accent Hatchback, Excel, Pony
F 026 A01 844				TOYOTA Land Cruiser
F 026 A05 ...				
F 026 A05 885				CHEVROLET Lanos
				DAEWOO Lanos, Lanos Hatchback, Lanos II
F 026 A05 886				TOYOTA Previa, Tarago
F 026 A05 887				MAZDA MPV
F 026 A05 889				TOYOTA Dyna
F 026 A05 891				HONDA Civic Hatchback, Civic Sedan
F 026 A05 892				TOYOTA Corolla, Corolla Altis, Corolla Fielder, Corolla Hatchback, Corolla RunX, Corolla Sedan, Corolla Verso, Corolla Wagon
F 026 A05 893				TOYOTA Previa
F 026 A05 898				TOYOTA Land Cruiser
F 026 A05 901				DAEWOO Matiz
F 026 A05 905				SUZUKI Baleno Hatchback, Baleno Sedan, Baleno Wagon
F 026 A05 906				SUZUKI Vitara, Vitara Cabrio
F 026 A05 907				TOYOTA Fortuner, Hilux, Hilux Vigo, Innova
F 026 A05 908				TOYOTA Hilux
F 026 A05 909				NISSAN X-Trail
F 026 A06 ...				
F 026 A06 486				TOYOTA Camry
F 026 A06 496				DAEWOO Lanos II

de

**Hauptbrems-
zylinder**
(Fortsetzung)

en

**Master
cylinders**
(continued)

fr

**Mâîtres-cylindres
de freins**
(suite)

it

**Pompa
freni**
(seguito)

es

**Cilindro
principal**
(continuación)



F 026 A06 497	DAEWOO	Lanos II
F 026 A06 500	SUZUKI	Grand Vitara
F 026 A06 501	TOYOTA	Land Cruiser
F 026 A06 502	HOLDEN	Barina
F 026 A06 504	FORD	Courier
F 026 A06 711	TOYOTA	Fortuner, Hilux, Hilux Vigo, Innova
F 026 A06 718	FORD	Festiva Hatchback
F 026 A06 902	SUBARU	Forester, Impreza Kombi, Impreza Sedan, Legacy Outback
F 026 A06 914	SAAB (SAAB AUTOMOBILE AB)	9-3, 9-3 Cabriolet, 9-3 Kombi, 9-3X
F 026 A06 918	HOLDEN	Rodeo
F 026 A06 921	TOYOTA	Camry
F 026 A06 922	TOYOTA	Camry
F 026 A06 923	TOYOTA	Hilux, Hilux Pickup
F 026 A06 924	FORD	Courier

F 026 A07 ...

F 026 A07 100	TOYOTA	Dyna
F 026 A07 130	TOYOTA	Dyna
F 026 A07 152	FORD	Falcon
F 026 A07 167	FORD	Fairlane, Falcon
F 026 A07 168	FORD	Falcon
F 026 A07 169	FORD	Falcon Utility
F 026 A07 171	FORD	Falcon
F 026 A07 173	FORD	Falcon
F 026 A07 175	FORD	Falcon
F 026 A07 195	FORD	Fairlane
F 026 A07 538	TOYOTA	Hilux
F 026 A07 556	MAZDA	323, 323 Hatchback
F 026 A07 564	MAZDA	MX-6, 626, 626 Hatchback
F 026 A07 565	MAZDA	323, 323 Hatchback
F 026 A07 590	NISSAN	Pathfinder
F 026 A07 591	TOYOTA	Land Cruiser
F 026 A07 600	NISSAN	Pulsar
F 026 A07 601	NISSAN	Pulsar Hatchback
F 026 A07 607	NISSAN	Pulsar Hatchback
F 026 A07 608	NISSAN	Pulsar, Pulsar Hatchback
F 026 A07 609	NISSAN	Pulsar Hatchback
F 026 A07 621	MAZDA	323 Astina, 323 Hatchback
F 026 A07 622	NISSAN	Pajero
F 026 A07 623	NISSAN	Pajero

F 026 A09 ...

F 026 A09 399	KIA	K 2500, K 2700
F 026 A09 544	HYUNDAI	Getz
F 026 A09 545	HYUNDAI	Getz
F 026 A09 636	NISSAN	L 200
F 026 A09 662	HONDA	Accord



F 026 003 ...

F 026 003 012	19	RENAULT	9, 11
F 026 003 060	19	CITROEN	C 15
F 026 003 070	25,4	FORD	Transit, Transit Euroline, Transit Nugget, Transit Tourneo
F 026 003 071	25,4	FORD	Transit, Transit Euroline, Transit Nugget, Transit Tourneo
F 026 003 076	20,6	CITROEN	C 15
F 026 003 078	17,5	RENAULT	5
F 026 003 096	20,6	PEUGEOT	405, 405 Break
F 026 003 103	19	CITROEN	AX
		PEUGEOT	106, 205, 205 Pickup
		RENAULT	Clio I, Express, Extra, Rapid, Megane I, 5, 19, 21, 21 Nevada
F 026 003 136	23,8	FORD	Transit, Transit Euroline, Transit Nugget, Transit Tourneo
F 026 003 138	22,22	RENAULT	Safrane
F 026 003 140	25,4	IVECO	CityClass, Daily, Daily Chassi, Daily Furgao, Daily MaxiVan, Daily Vetrato, Scudato
		RENAULT	Mascott
F 026 003 142	22,2	CITROEN	ZX
		PEUGEOT	405, 405 Break
F 026 003 149	20,6	IVECO	Daily
F 026 003 150	22,2	CITROEN	C 25
		FIAT	Ducato 10, Ducato 12, Ducato 14, Talento
F 026 003 151	20,6	RENAULT	Twingo I
F 026 003 166	23,8	CITROEN	Evasion, Jumpy
		FIAT	Scudo, Ulysse
		PEUGEOT	Expert, 806
F 026 003 168	19	PEUGEOT	306
F 026 003 170	20,6	PEUGEOT	306, 306 Cabriolet
F 026 003 174	22,2	CITROEN	AX
		PEUGEOT	306, 306 Cabriolet
F 026 003 180	20,6	CITROEN	AX, ZX
		PEUGEOT	106, 205, 205 Pickup
		RENAULT	Clio I, Express, Extra, Rapid, Megane, Megane I, Megane I Cabrio, Megane I Classic, Megane I Coupé, Megane I Grandtour, Scenic I, Thalia, 19, 19 Cabrio

nl

Hoofdremcilinders
(vervolg)

sv

Huvudbromscylindrar
(fortsättning)

pt







Bomba principal do travão
(continuação)

cs

Hlavní brzdové válce
(pokračování)

ru

Главный тормозной цилиндр
(продолжение)

								
F 026 003 180	20,6	SEAT	Marbella, Terra		F 026 003 339	23,81	VW (VOLKSWAGEN)	Bora, Bora Variant, Golf, Golf IV, Golf IV Station Wagon, Golf IV Variant, Jetta, New Beetle, New Beetle Cabriolet
		VW (VOLKSWAGEN)	Golf I, Polo, Polo Classic, Polo Coupé					
F 026 003 184	22,2	RENAULT	Scenic I					
F 026 003 188	22,2	CITROEN	Evasion, Jumpy					
		PEUGEOT	Expert, 605, 806		F 026 003 342	20,6	CITROEN	Saxo, ZX
F 026 003 190	23,8	CITROEN	Berlingo				PEUGEOT	106, 306, 306 Cabriolet
		PEUGEOT	Partner, Ranch, 406, 406 Break, 406 Coupé		F 026 003 349	20,64	PEUGEOT	306
F 026 003 192	23,8	CITROEN	Berlingo		F 026 003 350	23,81	CITROEN	Berlingo, Xsara, Xsara Break, Xsara Coupé
		PEUGEOT	Partner, Ranch, 406, 406 Break, 406 Coupé				PEUGEOT	Partner, Ranch, 306, 306 Break, 306 Cabriolet
F 026 003 194	22,2	FIAT	Ducato 10, Ducato 12, Ducato 14, Talento		F 026 003 354	23,8	FORD	Transit, Transit Euroline, Transit Nugget, Transit Tourneo
F 026 003 207	19	CITROEN	Saxo					
		PEUGEOT	106, 306		F 026 003 366	23,81	MERCEDES-BENZ	Serie V, Vito
F 026 003 208	20,6	CITROEN	Saxo		F 026 003 370	25,4	MERCEDES-BENZ	Sprinter
		PEUGEOT	106		F 026 003 372	22	NISSAN	Kubistar
F 026 003 226	19,05	FIAT	Panda				RENAULT	Clio II, Kangoo I, Kangoo II
F 026 003 243	20,6	LANCIA	Dedra Berlina		F 026 003 405	23,81	VOLVO	S40 I, V40 I
		PEUGEOT	106, 205, 205 Pickup		F 026 003 410	23,81	RENAULT	Trafic
		RENAULT	Clio I, Megane, Megane I, Megane I Cabrio, Megane I Classic, Megane I Coupé		F 026 003 415	20,64	RENAULT	Clio II, Thalia
F 026 003 257	20,6	RENAULT	21, 21 Nevada		F 026 003 417	20,64	RENAULT	Clio II, Clio II Sedan, Thalia
F 026 003 262	20,6	AUTOBIANCHI	Y 10					
		LANCIA	Y 10		F 026 003 418	20,64	RENAULT	Clio II, Clio II Sedan, Thalia
F 026 003 266	20,6	FIAT	Punto, Punto Cabrio, Punto Van		F 026 003 419	20,64	PEUGEOT	206, 206+, 206 Sedan, 206 SW
		LANCIA	Y		F 026 003 430	19,05	FIAT	Cinquecento, Seicento
F 026 003 296	20,6	FIAT	Panda, Uno, Uno Van		F 026 003 484	23,81	MERCEDES-BENZ	Sprinter
F 026 003 313	25,4	CITROEN	Jumper				VW (VOLKSWAGEN)	LT
		FIAT	Ducato, Ducato Cargo, Ducato 10, Ducato 14, Ducato 18		F 026 003 486	26	MERCEDES-BENZ	Sprinter
		PEUGEOT	Boxer				VW (VOLKSWAGEN)	Crafter 30, Crafter 35, Crafter 50
F 026 003 315	25,4	CITROEN	Jumper		F 026 003 501		CITROEN	Xsara, Xsara Coupé
		FIAT	Ducato, Ducato Cargo, Ducato 10, Ducato 14, Ducato 18				PEUGEOT	306, 306 Cabriolet
		PEUGEOT	Boxer		F 026 003 502	22,2	CITROEN	Xsara, Xsara Break, Xsara Coupé
F 026 003 318	22,2	CITROEN	Jumper				PEUGEOT	206, 206 CC, 206 SW, 306, 306 Break
		FIAT	Ducato 10, Ducato 14		F 026 003 511	23,81	PEUGEOT	406, 406 Break, 406 Coupé
		PEUGEOT	Boxer		F 026 003 512	23,81	PEUGEOT	406, 406 Break, 406 Coupé
F 026 003 328	22,2	FIAT	Uno		F 026 003 516	23,81	CITROEN	Evasion, Jumpy
F 026 003 339	23,81	AUDI	A3, TT Coupé, TT Roadster				FIAT	Scudo, Ulysse
		SEAT	Leon, Leon Cupra, Toledo				LANCIA	Zeta
		SKODA	Octavia, Octavia Combi				PEUGEOT	Expert, 806

de

Hauptbremszylinder
(Fortsetzung)

nl

Hoofdremcilinders
(vervolg)

en

Master cylinders
(continued)

sv

Huvudbromscylindrar
(fortsättning)

fr

Maîtres-cylindres de freins
(suite)

pt

Bomba principal do travão
(continuação)

it

Pompa freni
(seguito)

cs

Hlavní brzdové válce
(pokračování)

es

Cilindro principal
(continuación)

ru

Главный тормозной цилиндр
(продолжение)

F 026 003 517	23,81	CITROEN	Evasion, Jumpy
		FIAT	Scudo, Ulysse
		PEUGEOT	Expert, 806
F 026 003 518	22,2	CITROEN	Evasion, Jumpy
		FIAT	Scudo, Ulysse
		PEUGEOT	Expert, 605, 806
F 026 003 528	22,2	ALFA ROMEO	145, 146
		FIAT	Brava, Bravo, Coupé, Marea, Marengo, Tempra, Tempra SW, Tipo
		LANCIA	Dedra Berlina, Dedra Station Wagon, Delta
F 026 003 536	23,81	CITROEN	Picasso, Xsara Picasso
F 026 003 562	20,6	SEAT	Arosa, Cordoba, Cordoba Vario, Ibiza, Toledo
		VW (VOLKSWAGEN)	Golf III, Golf III Variant, Jetta, Lupo, Passat, Passat Variant, Polo, Polo Classic, Polo Playa, Polo Variant, Vento
F 026 003 563	22	SEAT	Cordoba, Cordoba Vario, Ibiza, Inca, Toledo
		VW (VOLKSWAGEN)	Caddy, California T4, Caravelle T4, Corrado, Golf I, Golf III, Golf III Cabriolet, Golf III Variant, Golf IV Cabriolet, Jetta, Kombi, Multivan T4, Passat, Passat Variant, Polo Classic, Polo Playa, Polo Variant, Transporter T4, Vento
F 026 003 588	23,81	FIAT	Idea, Stilo, Stilo Multi Wagon
		LANCIA	Musa
F 026 003 594	23,8	FORD	Escort V/VI, Escort V/VI Cabrio, Escort V/VI Express, Escort V/VI RS, Escort V/VI Turnier, Escort V/VI XR3i, Escort V/VI XR3i Cabrio
F 026 003 603	20,64	FIAT	Punto, Punto Van

F 026 003 604	22,2	FIAT	Albea, Palio, Palio Weekend, Punto, Punto Van
F 026 003 608	23,81	FORD	Focus, Focus I, Focus I Turnier, Focus Sedan
F 026 003 622	22,2	ALFA ROMEO	156 Berlina, 156 Sport Wagon, 156 Sportwagon
		LANCIA	Lybra Berlina, Lybra Station Wagon
F 026 003 628	22,2	FIAT	Panda, Punto, Punto Van
		LANCIA	Ypsilon
F 026 003 633	23,81	CITROEN	Xsara Picasso
F 026 003 635	22,2	FIAT	Panda
		LANCIA	Ypsilon
F 026 003 636	20,6	LANCIA	Ypsilon
F 026 003 638	23,81	OPEL	Combo, Corsa, Tigra TwinTop
		VAUXHALL	Combo, Corsa, Tigra TwinTop
F 026 003 641	23,81	FIAT	Idea, Stilo, Stilo Multi Wagon
		LANCIA	Musa
F 026 003 648	20,6	FIAT	Panda
F 026 003 649	20,6	FIAT	Panda
F 026 003 650	20,64	FIAT	Panda
F 026 003 671	22,2	FIAT	Albea, Palio, Palio Weekend, Strada
F 026 003 701	23,81	FORD	Focus I, Focus I Turnier
F 026 003 704	23,81	TOYOTA	Avensis, Avensis Liftback, Avensis Wagon
F 026 003 715	22,2	AUDI	A3, A3 Cabriolet, A3 Sportback
		SEAT	Altea, Altea Freetrack, Altea XL, Leon, Toledo
		SKODA	Octavia, Octavia Combi
F 026 003 940	23,8	VW (VOLKSWAGEN)	Golf Plus, Golf V, Golf VI, Jetta V
		RENAULT	Espace II, Laguna I, Laguna I Grandtour, Megane I, Megane I Cabrio, Megane I Coupé, Safrane
F 026 003 942	23,81	PEUGEOT	406, 406 Break, 406 Coupé
F 026 003 943	19,05	LADA	Serie 21000

de

Bremskraft-
verstärker

en

Brake booster

fr

Servofrein

it

Servofreno

es

Servofreno

nl

Rembekrachtiging

sv

Bromsservo

pt

Amplificador da força
de travagem

cs

Posilovač brzdného
účinku

ru

Усилитель
тормозного привода**0 204 B55 ...****0 204 B55 420** SUZUKI Alto Hatchback**0 204 0C2 ...****0 204 0C2 081** VW (VOLKSWAGEN) Fox**0 204 0C2 082** VW (VOLKSWAGEN) Fox**0 204 0C2 083** VW (VOLKSWAGEN) Fox**0 204 021 ...****0 204 021 576** RENAULT Mascott**0 204 021 584** RENAULT Mascott**0 204 021 676** NISSAN Primera Hatchback, Primera Sedan**0 204 021 677** NISSAN Primera Hatchback, Primera Sedan**0 204 021 797** NISSAN Primera Hatchback, Primera Sedan, Primera Wagon**0 204 021 799** NISSAN Primera Hatchback, Primera Sedan, Primera Wagon**0 204 021 834** MITSUBISHI Pajero Pinin**0 204 021 854** IVECO Daily**0 204 021 858** NISSAN Almera Hatchback**0 204 021 965** MITSUBISHI Carisma, Carisma Hatchback, Spacestar**0 204 021 966** MITSUBISHI Carisma, Carisma Hatchback, Spacestar**0 204 021 967** MITSUBISHI Carisma, Carisma Hatchback, Spacestar**0 204 021 968** MITSUBISHI Carisma, Carisma Hatchback, Spacestar**0 204 021 969** MITSUBISHI Carisma, Carisma Hatchback, Spacestar**0 204 021 970** MITSUBISHI Carisma, Carisma Hatchback**0 204 021 971** MITSUBISHI Carisma, Carisma Hatchback**0 204 023 ...****0 204 023 096** TOYOTA Yaris**0 204 023 097** TOYOTA Yaris**0 204 023 139** TOYOTA Camry**0 204 023 140** TOYOTA Camry**0 204 023 183** TOYOTA Ractis**0 204 023 184** TOYOTA Ractis**0 204 023 188** SUZUKI Grand Vitara**0 204 023 190** SUZUKI Grand Vitara**0 204 023 210** TOYOTA Yaris**0 204 023 347** TOYOTA Estima**0 204 023 610** DAIHATSU Materia, Sirion II**0 204 023 611** DAIHATSU Sirion II**0 204 023 612** DAIHATSU Materia, Sirion II**0 204 023 613** DAIHATSU Materia, Sirion II**0 204 023 774** SUZUKI SX4, SX4 Hatchback**0 204 023 826** DAIHATSU Materia, Sirion II**0 204 023 832** DAIHATSU Cuore**0 204 023 834** TOYOTA Vitz, Yaris**0 204 023 835** TOYOTA Vitz**0 204 023 840** TOYOTA Yaris**0 204 023 924** MAZDA 2**0 204 023 925** MAZDA 2**0 204 023 926** MAZDA 2**0 204 023 927** MAZDA 2**0 204 024 ...****0 204 024 069** FORD Transit, Transit Euroline, Transit Nugget, Transit Tourneo**0 204 024 181** FORD Transit, Transit Euroline, Transit Nugget, Transit Tourneo**0 204 024 273** NISSAN Almera Tino**0 204 024 274** NISSAN Almera Tino**0 204 024 592** FIAT Ducato 10, Ducato 11, Ducato 14, Ducato 15, Ducato 18**0 204 024 593** FIAT Ducato 10, Ducato 11, Ducato 14, Ducato 15, Ducato 18**0 204 024 692** FORD Transit**0 204 024 760** NISSAN Almera Hatchback, Almera Sedan, Almera Tino**0 204 032 ...****0 204 032 206** FIAT Fiorino Furgao**0 204 032 208** FORD Escort Hobby**0 204 032 348** FIAT Fiorino Furgao, Palio, Palio Weekend, Siena, Strada, Tempra**0 204 032 350** FORD Escort**0 204 032 350** VW (VOLKSWAGEN) Pointer**0 204 032 359** FIAT Fiorino, Fiorino Furgao**0 204 032 608** FIAT Fiorino Furgao**0 204 032 613** VW (VOLKSWAGEN) Gol III**0 204 032 618** TOYOTA Hilux**0 204 032 621** RENAULT Clio II, Clio II Sedan, Thalia**0 204 032 622** FIAT Albea, Palio, Palio Weekend, Siena, Strada**0 204 032 831** FORD Ranger**0 204 032 833** VW (VOLKSWAGEN) Gol III, Gol IV**0 204 032 926** FIAT Fiorino**0 204 051 ...****0 204 051 040** ALFA ROMEO GTV, Spider**0 204 051 043** ALFA ROMEO GTV**0 204 051 088** MERCEDES-BENZ Viano, Vito

de

**Bremskraft-
verstärker**
(Fortsetzung)

en

Brake booster
(continued)

fr

Servofrein
(suite)

it

Servofreno
(seguito)

es

Servofreno
(continuación)



0 204 051 162	NISSAN	Almera Tino
0 204 051 175	SUZUKI	Swift Hatchback
0 204 051 183	RENAULT	Mascott
0 204 051 360	IVECO	Daily
0 204 051 361	IVECO	Daily
0 204 051 528	NISSAN	Cabstar
0 204 051 534	SUZUKI	SX4 Hatchback
0 204 051 539	NISSAN	Cabstar
0 204 051 551	NISSAN	Qashqai, Qashqai+2
0 204 051 552	NISSAN	Qashqai, Qashqai+2
0 204 051 629	IVECO	Daily
0 204 051 673	OPEL	Agila
	SUZUKI	Splash, Swift Hatchback
	VAUXHALL	Agila
0 204 051 704	RENAULT	Mascott
0 204 051 706	RENAULT	Mascott
0 204 051 951	FIAT	Bravo

0 204 053 ...

0 204 053 125	LEXUS	ES
0 204 053 269	NISSAN	370 Z Coupé
0 204 053 359	TOYOTA	Camry
0 204 053 360	TOYOTA	Camry
0 204 053 361	TOYOTA	Camry
0 204 053 362	TOYOTA	Camry
0 204 053 425	MAZDA	2

0 204 054 ...

0 204 054 136	OPEL	Agila
	VAUXHALL	Agila
0 204 054 468	MERCEDES-BENZ	Sprinter
	VW	Crafter 30, Crafter 35,
	(VOLKSWAGEN)	Crafter 50

0 204 055 ...

0 204 055 051	AUDI	A3, A3 Cabriolet, A3 Sportback
	SEAT	Altea, Altea Freetrack, Altea XL, Leon, Toledo
	SKODA	Octavia, Octavia Combi
	VW	Golf Plus, Golf V,
	(VOLKSWAGEN)	Golf V Variant, Golf VI
0 204 055 380	SEAT	Cordoba, Cordoba Vario, Ibiza
	VW	Caddy, Polo Classic,
	(VOLKSWAGEN)	Polo Variant

0 204 125 ...

0 204 125 041	RENAULT	9, 11
0 204 125 047	RENAULT	Express, Extra, Rapid, 5
0 204 125 049	RENAULT	Express, Extra, Rapid, 5
0 204 125 054	VW	Polo, Polo Classic,
	(VOLKSWAGEN)	Polo Coupé
0 204 125 055	RENAULT	21, 21 Nevada
0 204 125 058	PEUGEOT	205, 205 Pickup
0 204 125 059	PEUGEOT	405, 405 Break



0 204 125 068	FORD	Transit
0 204 125 071	FORD	Escort VII, Escort VII Cabrio, Escort VII Express, Escort VII RS, Escort VII Turnier, Escort VII XR3i Cabrio, Escort V/VI, Escort V/VI Cabrio, Escort V/VI Express, Escort V/VI RS, Escort V/VI Turnier, Escort V/VI XR3i, Escort V/VI XR3i Cabrio
0 204 125 079	CITROEN	ZX
	PEUGEOT	205, 306, 306 Cabriolet
0 204 125 084	PEUGEOT	605
0 204 125 090	RENAULT	Safrane
0 204 125 092	RENAULT	Express, Extra, Rapid
0 204 125 094	CITROEN	AX, Saxo
	PEUGEOT	106
0 204 125 101	FORD	Transit, Transit Euroline, Transit Nugget, Transit Tourneo
0 204 125 102	CITROEN	AX
	PEUGEOT	106
0 204 125 104	CITROEN	AX
	PEUGEOT	106
0 204 125 107	PEUGEOT	806
0 204 125 109	CITROEN	Evasion, Jumpy
	PEUGEOT	Expert, 806
0 204 125 111	RENAULT	Twingo I
0 204 125 112	VOLVO	V90, 940, 960
0 204 125 115	RENAULT	Clio I
0 204 125 119	RENAULT	Laguna I, Laguna I Grandtour
0 204 125 127	FORD	Transit, Transit Euroline, Transit Nugget, Transit Tourneo
0 204 125 132	VOLVO	S40 I, V40 I
0 204 125 134	CITROEN	Berlingo, ZX
	PEUGEOT	Partner, Ranch, 205, 205 Pickup, 306, 306 Break, 306 Cabriolet
0 204 125 139	PEUGEOT	406, 406 Break, 406 Coupé
0 204 125 141	PEUGEOT	406, 406 Break, 406 Coupé
0 204 125 143	PEUGEOT	406, 406 Break, 406 Coupé
0 204 125 145	PEUGEOT	406, 406 Break, 406 Coupé
0 204 125 146	RENAULT	Twingo I
0 204 125 149	RENAULT	19, 19 Cabrio
0 204 125 151	RENAULT	19, 19 Cabrio
0 204 125 153	RENAULT	Clio I
0 204 125 161	RENAULT	Clio I
0 204 125 166	RENAULT	Megane, Megane I, Megane I Cabrio, Megane I Classic, Megane I Coupé

nl

Rembekrachtiging
(vervolg)

sv

Bromsservo
(fortsättning)

pt

**Amplificador da força
de travagem**
(continuação)

cs

**Posilovač brzdného
účinku**
(pokračování)

ru

**Усилитель
тормозного привода**
(продолжение)

		
0 204 125 170	RENAULT	Megane I, Megane I Cabrio, Megane I Coupé
0 204 125 216	CITROEN	Saxo
	PEUGEOT	106
0 204 125 254	SEAT	Arosa
	VW (VOLKSWAGEN)	Lupo, Polo
0 204 125 262	SEAT	Cordoba, Cordoba Vario, Ibiza
	VW (VOLKSWAGEN)	Caddy, Polo Classic, Polo Variant
0 204 125 263	SEAT	Cordoba, Cordoba Vario, Ibiza, Inca
	VW (VOLKSWAGEN)	Caddy, Polo Classic, Polo Variant
0 204 125 264	SEAT	Cordoba, Cordoba Vario, Ibiza
	VW (VOLKSWAGEN)	Polo Classic, Polo Playa, Polo Variant
0 204 125 266	IVECO	Daily Chassi, Daily Furgao, Daily MaxiVan, Scudato
0 204 125 299	IVECO	Daily
0 204 125 318	IVECO	Daily
0 204 125 351	FIAT	Uno, Uno Van
0 204 125 360	FIAT	Uno, Uno Van
0 204 125 362	LANCIA	Thema Berlina, Thema Station Wagon
0 204 125 369	FIAT	Uno
0 204 125 371	AUTOBIANCHI	Y 10
	LANCIA	Y 10
0 204 125 391	IVECO	Daily
0 204 125 393	IVECO	Daily
0 204 125 405	ALFA ROMEO	155
0 204 125 409	FIAT	Croma
	LANCIA	Thema Berlina, Thema Station Wagon
0 204 125 416	FIAT	Ducato 10, Ducato 12, Ducato 14, Talento
0 204 125 417	FIAT	Ducato 10, Ducato 12, Ducato 14, Talento
0 204 125 420	CITROEN	C 25
	FIAT	Ducato 10, Ducato 12, Ducato 14, Talento
0 204 125 422	FIAT	Ducato 18
0 204 125 423	FIAT	Ducato 10, Ducato 12, Ducato 14, Talento
0 204 125 426	FIAT	Croma
0 204 125 430	IVECO	Daily
0 204 125 431	ALFA ROMEO	GTV, Spider, 145, 146, 155
	FIAT	Bravo, Marea, Marea Weekend
	LANCIA	Dedra Station Wagon
0 204 125 433	FIAT	Croma
0 204 125 436	ALFA ROMEO	145, 146
	FIAT	Brava, Bravo, Coupé, Marea, Marengo, Tempra, Tempra SW, Tipo

		
0 204 125 436	LANCIA	Dedra Berlina, Dedra Station Wagon, Delta
0 204 125 439	ALFA ROMEO	155
0 204 125 443	FIAT	Marengo, Tempra, Tempra SW, Tipo
	LANCIA	Dedra Berlina
0 204 125 444	FIAT	Marengo, Tempra, Tempra SW, Tipo
0 204 125 445	CITROEN	Jumper
	FIAT	Ducato 10, Ducato 14
	PEUGEOT	Boxer
0 204 125 446	FIAT	Panda
0 204 125 449	FIAT	Panda
0 204 125 450	FIAT	Cinquecento, Seicento
0 204 125 459	IVECO	Daily
0 204 125 467	FIAT	Barchetta, Punto, Punto Cabrio, Punto GT, Punto Van
	LANCIA	Y
0 204 125 474	FIAT	Punto, Punto Cabrio, Punto Van
	LANCIA	Y
0 204 125 476	FIAT	Coupé
0 204 125 481	MITSUBISHI	Carisma, Carisma Hatchback
0 204 125 484	CITROEN	Saxo
	PEUGEOT	106
0 204 125 485	CITROEN	Saxo
	PEUGEOT	106
0 204 125 491	FORD	Cougar, Mondeo I, Mondeo II, Mondeo II Turnier
0 204 125 492	FORD	Cougar, Mondeo I, Mondeo II, Mondeo II Turnier
0 204 125 499	FORD	Mondeo, Mondeo I, Mondeo I Turnier, Mondeo II, Mondeo II Turnier
0 204 125 500	FORD	Mondeo I, Mondeo I Turnier, Mondeo II, Mondeo II Turnier
0 204 125 502	NISSAN	Primera Hatchback, Primera Sedan, Primera Wagon
0 204 125 505	AUDI	A3, TT Coupé, TT Roadster
	SEAT	Leon, Leon Cupra, Toledo
	SKODA	Octavia, Octavia Combi
	VW (VOLKSWAGEN)	Bora, Bora Variant, Golf IV, Golf IV Station Wagon, Golf IV Variant, Jetta IV, New Beetle, New Beetle Cabriolet
0 204 125 508	CITROEN	ZX
0 204 125 514	CITROEN	Berlingo, Xsara, Xsara Break, Xsara Coupé
	PEUGEOT	Partner, 306, 306 Break, 306 Cabriolet
0 204 125 516	SEAT	Arosa
	VW (VOLKSWAGEN)	Lupo, Polo
0 204 125 517	SEAT	Cordoba, Cordoba Vario, Ibiza
0 204 125 519	IVECO	CityClass, Daily, Scudato

de

**Bremskraft-
verstärker**
(Fortsetzung)

en

Brake booster
(continued)

fr

Servofrein
(suite)

it

Servofreno
(seguito)

es

Servofreno
(continuación)

0 204 125 520	IVECO	Daily
0 204 125 526	RENAULT	Scenic I
0 204 125 527	RENAULT	Twingo I
0 204 125 528	RENAULT	Twingo I
0 204 125 529	RENAULT	Scenic I
0 204 125 531	FORD	Transit, Transit Euroline, Transit Nugget, Transit Tourneo
0 204 125 533	RENAULT	Megane, Megane I, Megane I Cabrio, Megane I Classic, Megane I Coupé
0 204 125 550	CITROEN	C 25
	FIAT	Ducato 12, Ducato 18
0 204 125 556	MERCEDES-BENZ	Serie V, Vito
0 204 125 576	VOLVO	S40 I, V40 I
0 204 125 580	RENAULT	Trafic
0 204 125 601	ALFA ROMEO	145, 146, 155
	FIAT	Brava, Bravo, Coupé, Marea, Marengo, Tipo
	LANCIA	Dedra Berlina, Dedra Station Wagon, Delta
0 204 125 602	FIAT	Brava, Bravo, Marea, Marengo, Tempra, Tempra SW, Tipo
0 204 125 604	PEUGEOT	206
0 204 125 605	PEUGEOT	206, 206 Sedan, 206 SW
0 204 125 661	VOLVO	740, 940, 960
0 204 125 663	VOLVO	S90, 740, 940, 960
0 204 125 714	CITROEN	Evasion, Jumpy
	PEUGEOT	Expert
0 204 125 715	CITROEN	Evasion, Jumpy
	FIAT	Scudo, Ulysse
	LANCIA	Zeta
	PEUGEOT	Expert, 806
0 204 125 716	CITROEN	Evasion, Jumpy
0 204 125 717	SEAT	Leon, Leon Cupra, Toledo
	SKODA	Octavia, Octavia Combi
	VW (VOLKSWAGEN)	Golf IV, Jetta
0 204 125 719	SEAT	Leon, Leon Cupra, Toledo
	SKODA	Octavia, Octavia Combi
0 204 125 724	FIAT	Brava, Bravo, Marea, Marengo, Tipo
	LANCIA	Dedra Berlina
0 204 125 728	FIAT	Palio, Palio Weekend, Siena
0 204 125 729	FIAT	Brava, Bravo, Marea
0 204 125 730	ALFA ROMEO	GTV, Spider
0 204 125 731	FIAT	Punto, Punto Van
0 204 125 732	LANCIA	Dedra Berlina
0 204 125 733	RENAULT	Clio II, Thalia
0 204 125 734	CITROEN	Picasso, Xsara Picasso
0 204 125 741	MERCEDES-BENZ	Sprinter
	VW (VOLKSWAGEN)	LT
0 204 125 742	OPEL	Agila
	SUZUKI	Wagon R+
	VAUXHALL	Agila

0 204 125 746	CITROEN	Jumper
	FIAT	Ducato, Ducato 10, Ducato 14, Ducato 18
	PEUGEOT	Boxer
0 204 125 747	FIAT	Multipla
0 204 125 748	CITROEN	C5, C5 Break
0 204 125 749	CITROEN	C5, C5 Break
0 204 125 750	CITROEN	Xsara, Xsara Break, Xsara Coupé
0 204 125 751	CITROEN	Xsara, Xsara Break, Xsara Coupé
0 204 125 753	TOYOTA	Yaris
0 204 125 754	TOYOTA	Yaris
0 204 125 756	FIAT	Panda
0 204 125 763	RENAULT	Clio II, Kangoo I, Kangoo II
0 204 125 764	CITROEN	Berlingo
	PEUGEOT	Partner, Ranch
0 204 125 770	RENAULT	Twingo I
0 204 125 771	RENAULT	Twingo I
0 204 125 772	CITROEN	Jumper
	FIAT	Ducato, Ducato Cargo, Ducato 10, Ducato 14, Ducato 18
	PEUGEOT	Boxer
0 204 125 773	CITROEN	Jumper
	FIAT	Ducato 10, Ducato 14
	PEUGEOT	Boxer
0 204 125 776	CITROEN	C4, C4 Coupé
	PEUGEOT	307, 307 Break/SW
0 204 125 777	CITROEN	C4, C4 Coupé, C4 Sedan
	PEUGEOT	307, 307 Break/SW, 307 CC, 307 Sedan
0 204 125 779	CITROEN	C5, C5 Break
0 204 125 780	CITROEN	C5, C5 Break
0 204 125 783	FIAT	Stilo, Stilo Multi Wagon
0 204 125 784	FIAT	Stilo, Stilo Multi Wagon
0 204 125 785	FIAT	Stilo, Stilo Multi Wagon
0 204 125 786	RENAULT	Kangoo I
0 204 125 787	RENAULT	Kangoo I
0 204 125 788	RENAULT	Clio II
0 204 125 790	JAGUAR	X-Type, X-Type Estate
0 204 125 791	CITROEN	C8
	PEUGEOT	807
0 204 125 792	CITROEN	C8
	PEUGEOT	807
0 204 125 794	RENAULT	Twingo I
0 204 125 795	RENAULT	Clio II
0 204 125 796	RENAULT	Clio II
0 204 125 801	CITROEN	Jumper
	FIAT	Ducato, Ducato Cargo, Ducato Minibus, Ducato 10, Ducato 11, Ducato 14, Ducato 15, Ducato 18
	PEUGEOT	Boxer

nl

Rembekrachtiging
(vervolg)

sv

Bromsservo
(fortsättning)

pt

Amplificador da força
de travagem
(continuação)

cs

Posilovač brzdného
účinku
(pokračování)

ru

Усилитель
тормозного привода
(продолжение)

		
0 204 125 802	RENAULT	Twingo I
0 204 125 803	ALFA ROMEO	156 Berlina
0 204 125 804	CITROEN	Berlingo
	PEUGEOT	Partner
0 204 125 805	CITROEN	Berlingo
	PEUGEOT	Partner
0 204 125 806	FIAT	Albea, Palio, Palio Weekend
0 204 125 807	FIAT	Albea, Palio, Palio Weekend, Strada
0 204 125 808	LANCIA	Ypsilon
0 204 125 809	TOYOTA	Avensis, Avensis Liftback, Avensis Wagon, Corolla Verso
0 204 125 810	TOYOTA	Avensis, Avensis Liftback, Avensis Wagon, Corolla Verso
0 204 125 811	RENAULT	Master, Master I, Master II
0 204 125 812	OPEL	Combo, Corsa, Tigra TwinTop
	VAUXHALL	Combo, Corsa, Tigra TwinTop
0 204 125 813	OPEL	Combo, Corsa
	VAUXHALL	Combo, Corsa
0 204 125 814	FIAT	Idea
	LANCIA	Musa
0 204 125 815	SUZUKI	Ignis Hatchback
0 204 125 816	FIAT	Panda
0 204 125 817	FIAT	Panda
0 204 125 818	TOYOTA	Yaris
0 204 125 819	RENAULT	Master, Master II
0 204 125 820	CITROEN	C2, C3, C3-Pluriel
	PEUGEOT	1007
0 204 125 821	PEUGEOT	206, 206+
0 204 125 823	CITROEN	C4, C4 Coupé, C4 Sedan
	PEUGEOT	307, 307 Break/SW, 307 CC, 307 Sedan
0 204 125 827	OPEL	Meriva
	VAUXHALL	Meriva
0 204 125 828	IVECO	CityClass, Daily, Daily Chassi, Daily Furgao, Daily MaxiVan, Daily Vetrato
0 204 125 830	CITROEN	C1
	PEUGEOT	107
	TOYOTA	Aygo
0 204 125 831	CITROEN	C1
	PEUGEOT	107
	TOYOTA	Aygo
0 204 125 833	FIAT	Bravo, Stilo, Stilo Multi Wagon
0 204 125 834	FIAT	Stilo, Stilo Multi Wagon
0 204 125 835	NISSAN	Primera, Primera Hatchback, Primera Wagon
0 204 125 837	CITROEN	Berlingo
0 204 125 845	FORD	Mondeo III, Mondeo III Turnier
0 204 125 846	FORD	Mondeo III, Mondeo III Turnier
0 204 125 847	FIAT	Panda
0 204 125 849	FIAT	Ducato 11
0 204 125 850	FIAT	Grande Punto, Linea, Punto Grande

		
0 204 125 852	ALFA ROMEO	MiTo
	FIAT	Fiorino, Grande Punto, Punto, Punto Evo, Punto Grande, Qubo
0 204 125 853	ALFA ROMEO	MiTo
	FIAT	Punto, Punto Evo, Punto Grande Abarth, Punto Grande Abarth SS
0 204 125 856	FIAT	Doblo, Doblo Cargo
0 204 125 857	FORD	Transit, Transit Euroline, Transit Nugget, Transit Tourneo
0 204 125 858	FIAT	Ducato 11, Ducato 15, Ducato 110, Ducato 115, Ducato 130, Ducato 150, Ducato 180
0 204 125 859	FIAT	Ducato 11, Ducato 15, Ducato 110, Ducato 115, Ducato 130, Ducato 150, Ducato 180
0 204 125 860	FIAT	Ducato 17, Ducato 20, Ducato 110, Ducato 115, Ducato 130, Ducato 150, Ducato 180
0 204 125 861	FIAT	Ducato 17, Ducato 20, Ducato 110, Ducato 115, Ducato 130, Ducato 150, Ducato 180
0 204 125 866	FIAT	Doblo, Doblo Cargo
0 204 125 868	FIAT	Idea
	LANCIA	Musa
0 204 125 869	OPEL	Adam, Corsa
	VAUXHALL	Adam, Corsa
0 204 125 870	OPEL	Adam, Corsa
	VAUXHALL	Adam, Corsa
0 204 125 875	TOYOTA	Auris
0 204 125 877	TOYOTA	Auris, Corolla
0 204 125 878	TOYOTA	Auris
0 204 125 879	TOYOTA	Auris
0 204 125 880	TOYOTA	Auris
0 204 125 882	TOYOTA	Auris
0 204 125 884	TOYOTA	Auris, Corolla
0 204 125 885	TOYOTA	Auris, Corolla
0 204 125 886	TOYOTA	Auris, Corolla
0 204 125 887	HONDA	CR-V
0 204 125 888	HONDA	CR-V
0 204 125 889	HONDA	CR-V
0 204 125 890	HONDA	CR-V
0 204 125 891	RENAULT	Laguna III, Laguna III Coupé, Laguna III Grandtour
0 204 125 892	RENAULT	Laguna III, Laguna III Coupé, Laguna III Grandtour
0 204 125 893	RENAULT	Laguna III, Laguna III Coupé, Laguna III Grandtour
0 204 125 894	RENAULT	Laguna III, Laguna III Coupé, Laguna III Grandtour
0 204 125 895	JAGUAR	X-Type, X-Type Estate

de

**Bremskraft-
verstärker**
(Fortsetzung)

en

Brake booster
(continued)

fr

Servofrein
(suite)

it

Servofreno
(seguito)

es

Servofreno
(continuación)



0 204 125 896	JAGUAR	X-Type, X-Type Estate
0 204 125 899	IVECO	Daily
0 204 125 900	FIAT	Fiorino, Linea, Qubo
0 204 125 901	CITROEN	C4, C4 Coupé, C4 Sedan
	PEUGEOT	307, 307 Break/SW, 307 Sedan, 308, 308 CC, 308 SW
0 204 125 902	CITROEN	C4, C4 Coupé, C4 Sedan
	PEUGEOT	RCZ, 307, 307 Break/SW, 307 CC, 307 Sedan, 308, 308 CC, 308 SW
0 204 125 903	PEUGEOT	308 CC, 308 SW
0 204 125 904	PEUGEOT	308 CC, 308 SW
0 204 125 905	FIAT	Bravo
	LANCIA	Delta
0 204 125 906	FIAT	Bravo
	LANCIA	Delta
0 204 125 910	IVECO	Daily
0 204 125 912	TOYOTA	Avensis, Avensis Wagon
0 204 125 913	TOYOTA	Avensis, Avensis Wagon
0 204 125 914	TOYOTA	Avensis, Avensis Wagon
0 204 125 915	TOYOTA	Avensis, Avensis Wagon
0 204 125 916	ALFA ROMEO	MiTo
	FIAT	Grande Punto, Linea, Punto, Punto Evo, Punto Grande
0 204 125 917	ALFA ROMEO	MiTo
	FIAT	Punto, Punto Evo, Punto Grande Abarth, Punto Grande Abarth SS
0 204 125 935	FORD	Fiesta VI, Fiesta VII, Tourneo Courier, Transit Courier
0 204 125 937	FORD	Fiesta VI, Fiesta VII, Tourneo Courier, Transit Courier
0 204 125 946	FIAT	Doblo, Doblo Cargo
0 204 125 947	FIAT	Doblo, Doblo Cargo
0 204 125 948	RENAULT	Mascott
0 204 125 950	FIAT	Doblo, Doblo Cargo, 500X
	JEEP	Renegade
0 204 125 951	RENAULT	Fluence, Megane III Hatchback
0 204 125 952	RENAULT	Fluence, Megane III Hatchback
0 204 125 953	RENAULT	Fluence, Megane III Hatchback
0 204 125 954	RENAULT	Fluence, Megane III Hatchback
0 204 702 ...		
0 204 702 754	HONDA	CR-V
0 204 702 755	HONDA	CR-V
0 204 702 756	HONDA	CR-V
0 204 702 757	HONDA	CR-V
0 204 703 ...		
0 204 703 385	VW (VOLKSWAGEN)	Fox
0 204 706 ...		
0 204 706 814	MAHINDRA	Thar

**0 204 709 ...**

0 204 709 700	CITROEN	C4, DS4
0 204 709 701	CITROEN	C4, DS4
0 204 709 893	TOYOTA	Auris
0 204 709 895	TOYOTA	Auris
0 204 709 897	TOYOTA	Auris
0 204 709 899	TOYOTA	Auris
0 204 709 901	TOYOTA	Auris
0 204 709 903	TOYOTA	Auris

0 204 715 ...

0 204 715 886	TOYOTA	Auris
0 204 715 887	TOYOTA	Auris

0 204 716 ...

0 204 716 043	FIAT	Linea
----------------------	------	-------

0 204 718 ...

0 204 718 070	CITROEN	DS4
	PEUGEOT	RCZ, RCZ R, 308, 308 CC

0 204 719 ...

0 204 719 168	NISSAN	370 Z Coupé
0 204 719 169	NISSAN	370 Z Roadster
0 204 719 390	SUZUKI	Swift Hatchback
0 204 719 391	SUZUKI	Swift Hatchback
0 204 719 392	SUZUKI	Swift Hatchback
0 204 719 393	SUZUKI	Swift Hatchback
0 204 719 396	OPEL	Agila
	SUZUKI	Splash
	VAUXHALL	Agila
0 204 719 397	OPEL	Agila
	SUZUKI	Splash
	VAUXHALL	Agila
0 204 719 398	OPEL	Agila
	SUZUKI	Splash
	VAUXHALL	Agila
0 204 719 399	SUZUKI	Splash, Swift Hatchback
0 204 719 400	OPEL	Agila
	VAUXHALL	Agila
0 204 719 401	OPEL	Agila
	SUZUKI	Splash
	VAUXHALL	Agila

0 204 720 ...

0 204 720 315	TOYOTA	Avensis, Avensis Wagon
0 204 720 317	TOYOTA	Avensis, Avensis Wagon
0 204 720 418	CITROEN	C-Elysee, C3
	PEUGEOT	208, 301
0 204 720 419	CITROEN	C-Elysee, C3, DS3, DS3 Cabrio
	PEUGEOT	208, 301
0 204 720 420	CITROEN	C3

nl

Rembekrachtiging
(vervolg)

sv

Bromsservo
(fortsättning)

pt



**Amplificador da força
de travagem**
(continuação)



cs

**Posilovač brzdného
účinku**
(pokračování)

ru

**Усилитель
тормозного привода**
(продолжение)

					
0 204 720 421	CITROEN	C3, DS3, DS3 Cabrio			
	PEUGEOT	2008			
0 204 744 ...					
0 204 744 237	TOYOTA	Corolla Verso			
0 204 744 239	TOYOTA	Corolla Verso			
0 204 744 465	CITROEN	C1			
	PEUGEOT	107			
0 204 744 467	CITROEN	C1			
	PEUGEOT	107			
0 204 745 ...					
0 204 745 792	TOYOTA	Auris			
0 204 746 ...					
0 204 746 096	TOYOTA	Corolla			
0 204 748 ...					
0 204 748 113	SUZUKI	Swift Hatchback			
0 204 748 131	TOYOTA	Camry			
0 204 749 ...					
0 204 749 601	FIAT	Fiorino, Qubo			
0 204 769 ...					
0 204 769 753	NISSAN	Qashqai, Qashqai+2			
0 204 769 754	NISSAN	Qashqai, Qashqai+2			
0 204 770 ...					
0 204 770 683	LANCIA	Ypsilon			
0 204 770 684	LANCIA	Ypsilon			
0 204 771 ...					
0 204 771 794	ALFA ROMEO	MiTo			
0 204 776 ...					
0 204 776 113	OPEL	Corsa			
	VAUXHALL	Corsa			
0 204 776 115	OPEL	Corsa			
	VAUXHALL	Corsa			
0 204 776 858	TESLA MOTORS	Model S			
0 204 777 ...					
0 204 777 286	ALFA ROMEO	MiTo			
	FIAT	Fiorino, Punto, Punto Evo, Qubo			
0 204 777 297	OPEL	Combo			
	VAUXHALL	Combo			
0 204 777 301	OPEL	Combo			
	VAUXHALL	Combo			

					
0 204 781 ...					
0 204 781 366	FIAT	500L			
0 204 787 ...					
0 204 787 047	CHRYSLER	Neon			
	DODGE	Neon			
0 204 797 ...					
0 204 797 147	SUZUKI	SX4 S-Cross			
0 204 797 148	SUZUKI	SX4 S-Cross			
0 204 797 149	SUZUKI	SX4 S-Cross			
0 204 797 150	SUZUKI	SX4 S-Cross			
0 204 802 ...					
0 204 802 939	FORD	B-Max			
0 204 802 940	FORD	B-Max			
0 204 806 ...					
0 204 806 547	HONDA	CR-V			
0 204 806 549	HONDA	CR-V			
0 204 806 823	FIAT	500L			
0 204 807 ...					
0 204 807 695	TOYOTA	Auris			
0 204 808 ...					
0 204 808 616	FIAT	Bravo			
	LANCIA	Delta			
0 204 815 ...					
0 204 815 011	ALFA ROMEO	4C, 4C Spider			
0 204 815 532	NISSAN	Qashqai, X-Trail			
0 204 817 ...					
0 204 817 812	NISSAN	NT 500			
0 204 817 813	NISSAN	NT 500			
0 204 818 ...					
0 204 818 270	FIAT	Ducato			
0 204 818 271	FIAT	Ducato, Ducato 140			
0 204 822 ...					
0 204 822 651	CITROEN	C1			
	PEUGEOT	108			
0 204 822 653	CITROEN	C1			
	PEUGEOT	108			
0 204 822 655	CITROEN	C1			
	PEUGEOT	108			
0 204 822 657	CITROEN	C1			
	PEUGEOT	108			
0 204 822 659	CITROEN	C1			
	PEUGEOT	108			
0 204 822 661	CITROEN	C1			
	PEUGEOT	108			

de

**Bremskraft-
verstärker**
(Fortsetzung)

en

Brake booster
(continued)

fr

Servofrein
(suite)

it

Servofreno
(seguito)

es

Servofreno
(continuación)



0 204 824 ...

0 204 824 665	FIAT	500X
	JEEP	Renegade

0 204 828 ...

0 204 828 397	BMW	Serie 2 Grand Tourer
0 204 828 465	BMW	Serie 2 Active Tourer
0 204 828 467	BMW	Serie 2 Grand Tourer

0 204 831 ...

0 204 831 726	OPEL	Corsa
	VAUXHALL	Corsa
0 204 831 728	OPEL	Corsa
	VAUXHALL	Corsa

0 986 480 ...

0 986 480 679	FORD	Fiesta
---------------	------	--------

0 986 485 ...

0 986 485 006	OPEL	Corsa
	VAUXHALL	Nova
0 986 485 009	OPEL	Corsa
	VAUXHALL	Nova
0 986 485 088	ROVER	Mini, Mini Cabrio, Mini Cooper, Mini Cooper Cabrio, Mini De Ville, Mini De Ville Cabrio, Mini Margrave, Mini Retro Rally
0 986 485 089	ROVER	100 Metro, 100 Metro Cabrio
0 986 485 090	FORD	Fiesta III, Fiesta III Courier
0 986 485 094	CITROEN	AX
0 986 485 099	RENAULT	Espace II
0 986 485 100	OPEL	Omega
	VAUXHALL	Carlton III
0 986 485 104	PEUGEOT	306
0 986 485 105	PEUGEOT	306, 306 Cabriolet
0 986 485 106	RENAULT	19, 19 Cabrio
0 986 485 109	OPEL	Astra, Astra Cabrio, Astra Caravan, Calibra, Vectra
	VAUXHALL	Calibra, Cavalier III
0 986 485 110	VW (VOLKSWAGEN)	Corrado
0 986 485 111	VW (VOLKSWAGEN)	Golf III, Golf III Cabriolet, Golf III Variant, Jetta III, Vento
0 986 485 114	AUDI	S4, S6, S6 Avant, 80
0 986 485 117	NISSAN	Micra
0 986 485 119	FORD	Fiesta III, Fiesta III Courier
0 986 485 120	FORD	Fiesta III, Fiesta III Courier
0 986 485 122	BMW	Serie 3, Serie 3 Compact
0 986 485 126	ROVER	Serie 200, Serie 400, Serie 400 Tourer
0 986 485 127	NISSAN	Patrol



0 986 485 128	ROVER	Serie 400, Serie 400 Coupé, Serie 400 Tourer
0 986 485 129	FORD	Fiesta IV, Fiesta IV Courier, Puma
0 986 485 130	FORD	Fiesta IV, Fiesta IV Courier, Puma
0 986 485 134	MG	ZS
	ROVER	Serie 400, Serie 400 Coupé, Serie 400 Tourer, Serie 600, 45

F 01G 09B ...

F 01G 09B 0N7	MITSUBISHI	Lancer Hatchback
F 01G 09B 0PC	MAZDA	323 Wagon
F 01G 09B 0PW	NISSAN	Cedric Sedan
F 01G 09B 0RR	TOYOTA	Cressida Sedan
F 01G 09B 0RX	MITSUBISHI	L 300 Truck
F 01G 09B 0SA	MAZDA	Marathon, Serie E
F 01G 09B 0SB	MAZDA	E-Serie, Serie E
F 01G 09B 0S7	MITSUBISHI	L 200
F 01G 09B 0TD	TOYOTA	Cressida Sedan
F 01G 09B 0TU	MAZDA	323, 323 Hatchback
F 01G 09B 0UB	NISSAN	300 ZX
F 01G 09B 0VD	TOYOTA	Camry, Camry Wagon
F 01G 09B 0VH	TOYOTA	Camry, Camry Wagon
F 01G 09B 0VJ	TOYOTA	Camry, Camry Wagon
F 01G 09B 0VV	NISSAN	Cedric Sedan, Cedric Wagon
F 01G 09B 0V6	TOYOTA	Crown
F 01G 09B 0W9	MAZDA	RX-7 Coupé
F 01G 09B 0XB	SUZUKI	Cappuccino
F 01G 09B 0XC	SUZUKI	Wagon R+
F 01G 09B 0XG	NISSAN	Pulsar, Sunny
F 01G 09B 0XY	MITSUBISHI	Pajero, Pajero Cabrio
F 01G 09B 0XZ	MITSUBISHI	Colt, Lancer, Lancer Sedan
F 01G 09B 0X7	TOYOTA	Starlet
F 01G 09B 0X8	TOYOTA	Starlet
F 01G 09B 0YC	MAZDA	323 Hatchback, 323 Sedan
F 01G 09B 0YS	MAZDA	121 METRO Wagon
F 01G 09B 0YT	MAZDA	121 METRO Wagon
F 01G 09B 0YY	NISSAN	Hardbody
F 01G 09B 0Y3	MITSUBISHI	Galant, Galant Hatchback
F 01G 09B 0ZC	TOYOTA	Carina E Liftback, Carina E Sedan, Carina E Wagon
		Corolla Wagon
		Corolla
F 01G 09B 0ZL	TOYOTA	Corolla
F 01G 09B 0ZM	TOYOTA	Corolla
F 01G 09B 0ZX	MITSUBISHI	L 200
F 01G 09B 0ZY	MITSUBISHI	L 200
F 01G 09B 0Z4	NISSAN	Bluebird
F 01G 09B 1AB	TOYOTA	Picnic
F 01G 09B 1AZ	MITSUBISHI	Pajero, Pajero Cabrio
F 01G 09B 1A8	TOYOTA	Celica Liftback
F 01G 09B 1BA	MAZDA	626

nl

Rembekrachtiging
(vervolg)

sv

Bromsservo
(fortsättning)

pt



**Amplificador da força
de travagem**
(continuação)



cs

**Posilovač brzdného
účinku**
(pokračování)

ru

**Усилитель
тормозного привода**
(продолжение)

		
F 01G 09B 1BB	MAZDA	626, 626 Fastback, 626 Hatchback, 626 Wagon
F 01G 09B 1BH	MAZDA	323, 323 Astina Hatchback, 323 Hatchback, 323 Sedan
F 01G 09B 1BJ	MAZDA	RX-7 Coupé
F 01G 09B 1BK	MAZDA	E-Serie
F 01G 09B 1BL	MAZDA	323, 323 Hatchback
F 01G 09B 1B0	MAZDA	Lancer Evo4, Lancer Evo5/6
F 01G 09B 1B1	MAZDA	Xedos-6
F 01G 09B 1B4	MAZDA	Demio
F 01G 09B 1B6	MAZDA	Xedos-6, 626, 626 Hatchback
F 01G 09B 1B7	MAZDA	MX-6, 626, 626 Hatchback
F 01G 09B 1B9	MAZDA	Marathon
F 01G 09B 1CC	MAZDA	323, 323 Hatchback
F 01G 09B 1CH	MAZDA	Serie B
F 01G 09B 1CK	NISSAN	Almera
F 01G 09B 1CV	MAZDA	323, 323 Hatchback
F 01G 09B 1C8	MAZDA	Serie E
F 01G 09B 1C9	MAZDA	MPV
F 01G 09B 1DM	NISSAN	Maxima QX
F 01G 09B 1D8	NISSAN	350 Z, 350 Z Coupé
F 01G 09B 1EB	NISSAN	Sunny Neo
F 01G 09B 1EF	NISSAN	Pickup
F 01G 09B 1EG	NISSAN	Pickup
F 01G 09B 1EK	NISSAN	Hardbody
F 01G 09B 1EN	NISSAN	Pickup
F 01G 09B 1EU	NISSAN	Maxima QX
F 01G 09B 1EV	NISSAN	Teana
F 01G 09B 1EW	NISSAN	Teana
F 01G 09B 1FC	NISSAN	X-Trail
F 01G 09B 1FD	NISSAN	X-Trail
F 01G 09B 1FE	NISSAN	X-Trail
F 01G 09B 1FF	NISSAN	X-Trail
F 01G 09B 1FN	TOYOTA	Hiace Van, Hiace Wagon
F 01G 09B 1FS	TOYOTA	Land Cruiser, Land Cruiser Prado
F 01G 09B 1FU	TOYOTA	Land Cruiser, Land Cruiser Prado
F 01G 09B 1FW	TOYOTA	Camry, Camry Sedan
F 01G 09B 1FX	TOYOTA	Camry
F 01G 09B 1F2	NISSAN	AD Van
F 01G 09B 1GK	TOYOTA	Century Sedan
F 01G 09B 1GP	TOYOTA	Century Sedan
F 01G 09B 1HB	MAZDA	Lancer Evo7
F 01G 09B 1HF	MAZDA	Lancer, Lancer Station Wagon
F 01G 09B 1HJ	MAZDA	MPV
F 01G 09B 1HM	MAZDA	E-Serie
F 01G 09B 1H3	MAZDA	Outlander
F 01G 09B 1JE	MAZDA	Frontier
F 01G 09B 1J0	MAZDA	Serie B
F 01G 09B 1J5	MAZDA	Premacy
F 01G 09B 1J8	MAZDA	Premacy
F 01G 09B 1MN	MAZDA	Patrol GR
F 01G 09B 1MS	MAZDA	Patrol GR
F 01G 09B 1M2	MAZDA	Premacy

		
F 01G 09B 1M4	MAZDA	Premacy
F 01G 09B 1NB	TOYOTA	Dyna
F 01G 09B 1NE	TOYOTA	Dyna
F 01G 09B 1NF	TOYOTA	Dyna
F 01G 09B 1P4	MAZDA	121 METRO Wagon
F 01G 09B 1P5	MAZDA	121 METRO Wagon
F 01G 09B 1RZ	TOYOTA	Celica Coupé
F 01G 09B 1R1	TOYOTA	MR2 Cabrio
F 01G 09B 1SC	TOYOTA	Corolla, Corolla Hatchback, Corolla Verso, Corolla Wagon
F 01G 09B 1SD	TOYOTA	Corolla Hatchback, Corolla Sedan, Corolla Verso, Corolla Wagon
F 01G 09B 1SE	TOYOTA	Corolla, Corolla Hatchback, Corolla Wagon
F 01G 09B 1SF	TOYOTA	Corolla Hatchback, Corolla Sedan, Corolla Verso, Corolla Wagon
F 01G 09B 1SH	TOYOTA	Yaris Verso
F 01G 09B 1ST	TOYOTA	Yaris Verso
F 01G 09B 1SZ	TOYOTA	Pajero Pinin
F 01G 09B 1S3	TOYOTA	Celica Coupé
F 01G 09B 1TE	SUZUKI	Ignis Hatchback
F 01G 09B 1T1	MITSUBISHI	L 300 Van
F 01G 09B 1UG	NISSAN	Almera Hatchback, Almera Sedan
F 01G 09B 1UH	NISSAN	Almera Hatchback, Almera Sedan
F 01G 09B 1UJ	NISSAN	Almera Hatchback, Almera Sedan
F 01G 09B 1UK	NISSAN	Almera Hatchback, Almera Sedan
F 01G 09B 1UP	NISSAN	AD Van
F 01G 09B 1UR	NISSAN	AD Van
F 01G 09B 1UX	TOYOTA	Previa
F 01G 09B 1UY	TOYOTA	Previa
F 01G 09B 1VD	TOYOTA	RAV4
F 01G 09B 1VT	MITSUBISHI	Space Runner, Space Wagon
F 01G 09B 1VV	MITSUBISHI	Space Runner
F 01G 09B 1VW	MITSUBISHI	Space Runner, Space Wagon
F 01G 09B 1VX	MITSUBISHI	Space Wagon
F 01G 09B 1V2	TOYOTA	Previa
F 01G 09B 1V3	TOYOTA	Previa
F 01G 09B 1V5	TOYOTA	Previa
F 01G 09B 1V6	TOYOTA	Previa
F 01G 09B 1V7	TOYOTA	Previa
F 01G 09B 1WM	HONDA	Accord, Accord Tourer
F 01G 09B 1XE	MAZDA	MPV
F 01G 09B 1X0	MAZDA	E-Serie
F 01G 09B 1X1	TOYOTA	Previa

de

**Bremskraft-
verstärker**
(Fortsetzung)

en

Brake booster
(continued)

fr

Servofrein
(suite)

it

Servofreno
(seguito)

es

Servofreno
(continuación)



F 01G 09B 1X2	TOYOTA	Previa
F 01G 09B 1X3	TOYOTA	Previa
F 01G 09B 1X4	TOYOTA	Previa
F 01G 09B 1X5	TOYOTA	Previa
F 01G 09B 1X6	TOYOTA	Previa
F 01G 09B 10D	MAZDA	Xedos-6, 626
F 01G 09B 10E	MAZDA	MX-6, 626, 626 Hatchback
F 01G 09B 10G	MAZDA	323, 323 Hatchback, 626
F 01G 09B 10H	MAZDA	626
F 01G 09B 10J	MAZDA	626, 626 Fastback, 626 Hatchback
F 01G 09B 10K	MAZDA	626 Wagon
F 01G 09B 10P	MAZDA	323 Astina Hatchback
F 01G 09B 10U	MAZDA	626, 626 Fastback, 626 Hatchback, 626 Wagon
F 01G 09B 10V	MAZDA	626
F 01G 09B 10W	MAZDA	MX-6, Xedos-6, 626, 626 Hatchback
F 01G 09B 10X	MAZDA	MX-6, 626, 626 Hatchback
F 01G 09B 10Y	MAZDA	626
F 01G 09B 11K	MAZDA	323, 323 Astina Hatchback, 323 Hatchback, 323 Sedan
F 01G 09B 11L	MAZDA	323 Astina, 323 Hatchback
F 01G 09B 11T	TOYOTA	Dyna, Dyna 100, Dyna 150
F 01G 09B 12A	NISSAN	Sentra, 100 NX
F 01G 09B 12K	TOYOTA	Camry Sedan
F 01G 09B 12V	TOYOTA	Dyna
F 01G 09B 13K	NISSAN	Sentra, Sunny Hatchback, Sunny Sedan, 100 NX
F 01G 09B 13M	NISSAN	Pulsar, Pulsar Hatchback, Pulsar Sedan, Sunny
F 01G 09B 13Z	NISSAN	Frontier, Hardbody, Pickup
F 01G 09B 14A	NISSAN	Pulsar, Pulsar Hatchback
F 01G 09B 15B	MAZDA	Galant, Galant Hatchback
F 01G 09B 15C	MITSUBISHI	Galant, Galant Station Wagon
F 01G 09B 15D	MITSUBISHI	Galant, Galant Station Wagon
F 01G 09B 15E	MITSUBISHI	L 300 Van, L 300 Wagon
F 01G 09B 15G	MITSUBISHI	L 300 Truck
F 01G 09B 16D	NISSAN	Maxima QX
F 01G 09B 16F	NISSAN	Maxima QX
F 01G 09B 16K	NISSAN	Pathfinder
F 01G 09B 17T	MITSUBISHI	Sigma
F 01G 09B 17U	MITSUBISHI	Sigma
F 01G 09B 18U	NISSAN	Patrol GR
F 01G 09B 18V	NISSAN	Patrol GR
F 01G 09B 19C	NISSAN	Almera Hatchback, Almera Sedan, Pulsar Hatchback
F 01G 09B 19S	NISSAN	Pickup
F 01G 09B 19W	NISSAN	Pickup
F 01G 09B 22J	SUZUKI	Carry, Carry Van
F 01G 09B 22W	SUZUKI	Wagon R+
F 01G 09B 23T	MAZDA	323, 323 Hatchback



F 01G 09B 24E	MAZDA	Demio
F 01G 09B 24F	TOYOTA	Camry Sedan
F 01G 09B 24J	NISSAN	Pickup
F 01G 09B 27F	MITSUBISHI	Lancer, Lancer Station Wagon
F 01G 09B 101	MITSUBISHI	Colt, Lancer, Lancer Station Wagon
F 01G 09B 103	MITSUBISHI	Galant, Galant Hatchback
F 01G 09B 104	MITSUBISHI	Galant, Galant Station Wagon
F 01G 09B 105	MITSUBISHI	Galant, Galant Station Wagon
F 01G 09B 106	MITSUBISHI	Galant, Galant Station Wagon
F 01G 09B 107	MITSUBISHI	L 400
F 01G 09B 108	MITSUBISHI	L 400
F 01G 09B 143	NISSAN	Primera Wagon
F 01G 09B 151	MITSUBISHI	Colt, Lancer, Lancer Station Wagon
F 01G 09B 153	MITSUBISHI	Space Runner, Space Wagon
F 01G 09B 155	MITSUBISHI	Pajero, Pajero Cabrio
F 01G 09B 156	MITSUBISHI	L 200, L 200 Forte
F 01G 09B 158	MITSUBISHI	Pajero Sport
F 01G 09B 159	MITSUBISHI	Pajero Sport
F 01G 09B 169	CHEVROLET	Evanda
	DAEWOO	Evanda
F 01G 09B 174	NISSAN	Vanette
F 01G 09B 183	MITSUBISHI	Galant, Galant Station Wagon
F 01G 09B 184	MITSUBISHI	Galant, Galant Station Wagon
F 01G 09B 185	MITSUBISHI	L 400, Space Gear
F 01G 09B 186	MITSUBISHI	L 400, Space Gear
F 01G 09B 187	MITSUBISHI	L 400, Space Gear
F 01G 09B 188	MITSUBISHI	L 400, Space Gear
F 01G 09B 195	NISSAN	Sunny
F 01G 09B 294	SUBARU	Impreza Kombi, Impreza Sedan
F 01G 060 ...		
F 01G 060 1AM	ISUZU	Serie N
F 01G 061 ...		
F 01G 061 0D9	SUZUKI	Ignis Hatchback
F 01G 061 0FN	LEXUS	IS
F 01G 061 0FX	TOYOTA	Celica Coupé
F 01G 061 0GP	LEXUS	IS
F 01G 061 0GS	NISSAN	Teana
F 01G 061 0GT	NISSAN	Teana
F 01G 061 0GV	DAIHATSU	Copen
F 01G 061 0HZ	HONDA	Accord
F 01G 061 0JD	HONDA	Accord, Accord Tourer
F 01G 061 0JP	HONDA	Accord
F 01G 061 00L	SUZUKI	Ignis Hatchback
F 01G 061 0LG	NISSAN	Pickup
F 01G 061 0LH	NISSAN	NP300, Pickup
F 01G 061 0LJ	NISSAN	Pickup
F 01G 061 0LK	NISSAN	X-Trail
F 01G 061 0LP	NISSAN	Hardbody, NP300, Pickup
F 01G 061 0LR	NISSAN	Safari
F 01G 061 0LS	NISSAN	Patrol GR
F 01G 061 0LT	NISSAN	Safari

de

Kupplungs-
geberzylinder

en

Clutch sensor
cylinder

fr

Cylindre émetteur
d'embrayage

it

Pompa frizione

es

Cilindro principal
de embrague**0 204 122 ...**

0 204 122 215		ALFA ROMEO	145
----------------------	--	------------	-----

0 204 162 ...

0 204 162 024		RENAULT	Trafic
----------------------	--	---------	--------

0 204 162 037		RENAULT	21
----------------------	--	---------	----

0 204 162 048		NISSAN	Trade
----------------------	--	--------	-------

0 204 162 078		ALFA ROMEO	164
----------------------	--	------------	-----

0 204 162 081		FIAT	Croma, Uno, Uno Van
----------------------	--	------	------------------------

0 204 162 083		ALFA ROMEO	164
		LANCIA	Delta

0 204 162 088		LANCIA	Dedra Berlina
----------------------	--	--------	---------------

0 204 162 096		ALFA ROMEO	145, 146
----------------------	--	------------	----------

0 204 162 107		RENAULT	Espace II
----------------------	--	---------	-----------

0 204 163 ...

0 204 163 104		FIAT	Punto, Punto Cabrio, Punto GT, Punto Van
----------------------	--	------	---

0 204 318 ...

0 204 318 541		CHEVROLET	Tavera
----------------------	--	-----------	--------

0 986 AB8 ...

0 986 AB8 823	19,05	TOYOTA	Hilux Pickup
----------------------	-------	--------	--------------

0 986 AB8 824	20,64	TOYOTA	Hilux Pickup
----------------------	-------	--------	--------------

0 986 AB8 914	19,05	MITSUBISHI	L 200, Pajero Sport
----------------------	-------	------------	---------------------

0 986 AB8 917	15,88	MITSUBISHI	Galant, Galant Hatchback
----------------------	-------	------------	-----------------------------

0 986 AB8 923	15,88	TOYOTA	Avensis, Avensis Liftback, Avensis Wagon, Carina E Liftback, Carina E Sedan, Carina E Wagon
----------------------	-------	--------	--

0 986 486 ...

0 986 486 000	19,05	LADA	Niva, Serie 2100, Serie 21000, Toscana
----------------------	-------	------	---

0 986 486 015	19,05	AUDI	Cabriolet, Coupé, 80, 80 Avant
----------------------	-------	------	--------------------------------------

0 986 486 017	19	BMW	Serie 3, Serie 3 Cabrio, Serie 3 Compact, Serie 3 Coupé
----------------------	----	-----	--

0 986 486 021	19,05	MERCEDES-BENZ	3t, 4t
----------------------	-------	---------------	--------

0 986 486 024	19,05	AUDI	A6, A6 Avant, S4, 100, 100 Avant
----------------------	-------	------	-------------------------------------

0 986 486 028	19,05	BMW	Serie 5, Serie 5 Touring, Serie 7, Serie 8
----------------------	-------	-----	--

0 986 486 031	15,87	AUDI	A3, S3, TT Coupé, TT Roadster
----------------------	-------	------	----------------------------------

		SEAT	Leon, Leon Cupra, Leon Cupra R, Toledo
--	--	------	---

		SKODA	Octavia, Octavia Combi
--	--	-------	---------------------------

		VW (VOLKSWAGEN)	Bora, Bora Variant, Golf, Golf IV, Golf IV Station Wagon, Golf IV Variant, Jetta, New Beetle, New Beetle Cabriolet
--	--	--------------------	---

0 986 486 034	19,05	BMW	Serie Z, Serie 3, Serie 3 Cabrio, Serie 3 Compact, Serie 3 Coupé, Serie 3 Touring
----------------------	-------	-----	---

0 986 486 036	19,05	OPEL	Campo Pick-Up, Omega
		VAUXHALL	Omega

0 986 486 037	19,05	VW (VOLKSWAGEN)	California T4, Caravelle T4, Eurovan, Kombi, Multivan T4, Transporter T4
----------------------	-------	--------------------	---

0 986 486 038	19	SEAT	Cordoba, Cordoba Vario, Ibiza
		VW (VOLKSWAGEN)	Caddy, Golf III, Golf III Cabriolet, Golf III Variant, Golf IV Cabriolet, Polo Classic, Polo Variant, Vento

0 986 486 039	19,05	BMW	Serie 5, Serie 5 Touring, Serie 7
----------------------	-------	-----	--------------------------------------

0 986 486 040	19,05	BMW	Serie Z, Serie Z Coupé, Serie 3, Serie 3 Cabrio, Serie 3 Compact, Serie 3 Coupé, Serie 3 Touring
----------------------	-------	-----	---

0 986 486 041	19	SEAT	Toledo
		VW (VOLKSWAGEN)	Passat, Passat Variant

0 986 486 042	19	BMW	Serie 3 Touring
----------------------	----	-----	-----------------

0 986 486 043	19	MERCEDES-BENZ	Serie C, Serie C (T-Modell), Serie CLK (Cabrio), Serie CLK (Coupé), Serie E, Serie E (Cabrio), Serie E (Coupé), Serie E (T-Modell), Serie ML, Serie S, Serie SL, Serie SLK, Serie 190
----------------------	----	---------------	---

nl

Koppelings-
gevercilinder

sv

Kopplings-
cylinder

pt







Cilindro sensor
da embraigem

cs

Hlavní
válec spojky

ru

Цилиндр датчика
сцепления

							
0 986 486 044	15,9	HONDA	Accord Sedan, Prelude	0 986 486 060	15,87	SKODA	Fabia, Fabia Combi, Fabia Schrägheck, Octavia, Octavia Combi, Praktik, Roomster
0 986 486 045	19,05	VW (VOLKSWAGEN)	Golf III, Golf III Cabriolet, Golf III Variant, Golf IV Cabriolet, Vento			VW (VOLKSWAGEN)	Bora, Bora Variant, Jetta IV, Polo
0 986 486 047	15,87	AUDI	A3, S3, TT Coupé, TT Roadster	0 986 486 061	19,05	AUDI	A6, A6 Allroad, A6 Avant, S6, S6 Avant
		VW (VOLKSWAGEN)	Bora, Bora Variant, Golf IV, Golf IV Station Wagon, Golf IV Variant, Jetta IV			SKODA	Superb
0 986 486 048	15,87	VW (VOLKSWAGEN)	California T4, Caravelle T4, Kombi, Multivan T4, Transporter T4			VW (VOLKSWAGEN)	Passat, Passat Variant
0 986 486 049	19,05	BMW	Serie X, Serie Z, Serie 3, Serie 3 Cabrio, Serie 3 Coupé, Serie 3 Touring, Serie 5, Serie 5 Touring	0 986 486 062	19,05	AUDI	A4, A4 Avant, A4 Cabriolet, RS4, RS4 Avant, RS4 Cabriolet, S4, S4 Avant, S4 Cabriolet
		FORD	Galaxy			SEAT	Exeo, Exeo ST
0 986 486 050	19,05	SEAT	Alhambra	0 986 486 063	15,87	OPEL	Zafira
		VW (VOLKSWAGEN)	Sharan			VAUXHALL	Zafira
0 986 486 052	19,05	BMW	Serie 7	0 986 486 064	19,05	MERCEDES-BENZ	Serie C, Serie C (Sportcoupe), Serie C (T-Modell), Serie CLC, Serie CLK (Cabrio), Serie CLK (Coupé), Serie SLK
0 986 486 053	19,05	MERCEDES-BENZ	Serie V, Sprinter, Vito, 311 Sprinter, 411 Sprinter	0 986 486 065	19,05	BMW	Serie X, Serie Z, Serie Z Coupé, Serie 1, Serie 1 Cabrio, Serie 1 Coupé, Serie 2 Cabrio, Serie 2 Coupé, Serie 3, Serie 3 Cabrio, Serie 3 Compact, Serie 3 Coupé, Serie 3 GT, Serie 3 Touring, Serie 4 Cabrio, Serie 4 Coupé, Serie 4 GC, Serie 5, Serie 5 Touring
		VW (VOLKSWAGEN)	LT			FORD	Focus I, Focus I Turnier, Tourneo Connect, Transit Connect
0 986 486 054	19,05	AUDI	A4, A4 Avant, A6, A6 Allroad, A6 Avant, RS4 Avant, S4, S4 Avant, S6, S6 Avant	0 986 486 066	19,05	FORD	Focus I, Focus I Turnier, Tourneo Connect, Transit Connect
		SKODA	Superb	0 986 486 067	19,05	FORD	Fiesta IV, Fiesta IV Courier, Ka, Puma, Streetka
		VW (VOLKSWAGEN)	Passat, Passat Variant				
0 986 486 055	19,05	FORD	Cougar, Mondeo I, Mondeo I Turnier, Mondeo II, Mondeo II Turnier				
0 986 486 056	19,05	MERCEDES-BENZ	2t, 3t, 4t				
0 986 486 060	15,87	AUDI	A3, TT Coupé, TT Roadster				
		SEAT	Cordoba, Ibiza, Leon, Leon Cupra, Leon Cupra R, Toledo				

de

**Kupplungs-
geberzylinder**
(Fortsetzung)

en

**Clutch sensor
cylinder**
(continued)

fr

**Cylindre émetteur
d'embrayage**
(suite)

it

Pompa frizione
(seguito)

es

**Cilindro principal
de embrague**
(continuación)



0 986 486 068				HOLDEN Astra
				OPEL Astra, Astra Cabrio, Astra Caravan, Astra Coupé, Astra GTC, Astra TwinTop
				VAUXHALL Astra, Astra Convertible, Astra Coupé, Astra Estate, Astra GTC, Astra TwinTop, Astra Van
0 986 486 073	15,87		FIAT	Punto, Punto Van
0 986 486 077	15,87		FIAT	Punto, Punto Van
0 986 486 083	19			AUDI A4, A4 Avant, A6
				VW (VOLKSWAGEN) Passat, Passat Variant
0 986 486 084	15,87		ALFA ROMEO	GT, 147
0 986 486 091	15,87		FIAT	Doblo, Doblo Cargo
0 986 486 092	15,87		FIAT	Punto, Punto Van
0 986 486 095	15,87			OPEL Vectra, Vectra Caravan
				VAUXHALL Vectra, Vectra Estate
0 986 486 104	15,87		ALFA ROMEO	156 Berlina, 156 Sport Wagon, 156 Sportwagon
0 986 486 105	15,87			FIAT Idea
				LANCIA Musa, Ypsilon
0 986 486 107	15,8		FIAT	Stilo, Stilo Multi Wagon
0 986 486 108	15,8		MERCEDES-BENZ	Serie A, Vaneo
0 986 486 109	15,8			SEAT Cordoba, Cordoba Vario, Ibiza, Inca
				VW (VOLKSWAGEN) Caddy, Polo Classic, Polo Variant
				OPEL Signum, Vectra, Vectra Caravan
0 986 486 110	15,87			SAAB (SAAB AUTOMOBILE AB) 9-3, 9-3 Cabriolet, 9-3 Kombi, 9-3X
				VAUXHALL Signum, Vectra, Vectra Estate
				FIAT Bravo, Stilo, Stilo Multi Wagon
0 986 486 140	15,87		FIAT	Bravo, Stilo, Stilo Multi Wagon
0 986 486 141	15,87		MERCEDES-BENZ	Serie A
0 986 486 142	15,87			HONDA Civic Aerodeck, Civic CRX, Civic Fastback, Civic Hatchback
				TOYOTA Corolla, Corolla Hatchback, Corolla Liftback, Corolla Sedan, Corolla Wagon
				FIAT Bravo, Stilo, Stilo Multi Wagon
				MERCEDES-BENZ Serie A

0 986 486 144	19,05		LAND ROVER GROUP	Defender 90, Defender 110, Defender 130	
0 986 486 146	15,87		VW (VOLKSWAGEN)	Golf III, Golf III Variant, Polo Classic, Polo Variant, Vento	
0 986 486 147	15,87		NISSAN	Primastar	
			OPEL	Vivaro	
			RENAULT	Trafic II	
0 986 486 148	15,87		VAUXHALL	Vivaro	
			FORD	Transit, Transit Euroline, Transit Nugget, Transit Tourneo	
			FIAT	Punto, Punto Van	
0 986 486 150	19,05			FORD C-MAX, Focus C-MAX, Focus II, Focus II Cabriolet, Focus II Turnier, Focus III, Focus III Turnier, Kuga	
				MAZDA	3, 3 Hatchback, 5
				VOLVO	C30, S40 II, V50
				LANCIA	Kappa Berlina, Kappa Coupé, Kappa Station Wagon
				FIAT	Palio, Palio Weekend, Petra, Siena
F 009 D00 ...					
F 009 D00 768			LANCIA	Kappa Berlina, Kappa Coupé, Kappa Station Wagon	
F 009 D00 769			FIAT	Palio, Palio Weekend, Petra, Siena	
F 009 D00 856			ALFA ROMEO	166	
F 026 A01 ...					
F 026 A01 615			DAIHATSU	Delta	
F 026 A01 818			TOYOTA	Hilux	
F 026 A01 822			MITSUBISHI	L 200, L 200 Forte, Pajero Sport	
F 026 A01 829			MAZDA	Serie B	
F 026 A01 838			NISSAN	Urvan	
F 026 A01 842			FORD	Probe	
			MAZDA	MX-6, 323, 323 Hatchback, 626, 626 Hatchback	
F 026 A01 843			MAZDA	Bongo Wagon, E-Serie, Serie E	
F 026 A01 848			NISSAN	Pickup	
F 026 A01 853			TOYOTA	Starlet	
F 026 A01 854			TOYOTA	Camry, Camry Wagon	
F 026 A01 855			TOYOTA	Hiace Van, Hiace Wagon	
F 026 A01 857			TOYOTA	Corolla, Corolla Hatchback, Corolla Liftback, Corolla Sedan, Corolla Wagon	

nl

**Koppelings-
gevercilinder**
(vervolg)

sv

**Kopplings-
cylinder**
(fortsättning)

pt

**Cilindro sensor
da embraiaçom**
(continuação)



cs

**Hlavní
válec spojky**
(pokračování)

ru

**Цилиндр датчика
сцепления**
(продолжение)

			
F 026 A01 864		SUZUKI	Baleno Hatchback, Baleno Sedan, Baleno Wagon, Swift Sedan, Vitara
F 026 A01 865		HYUNDAI	Accent, Accent Hatchback, Elantra, Excel, Lantra, Pony
F 026 A01 866		NISSAN	Patrol GR, Pickup
F 026 A01 867		TOYOTA	Land Cruiser
F 026 A01 871		HYUNDAI	Accent, Accent Hatchback, Excel, Excel Hatchback, Pony
F 026 A01 872		HYUNDAI	Coupé, Elantra, Lantra, Lantra Kombi
F 026 A01 874		MAZDA	323 Astina, 323 Astina Hatchback, 323 Hatchback, 323 Sedan
F 026 A01 875		HONDA	Prelude
F 026 A01 876		MITSUBISHI	Space Runner, Space Wagon
F 026 A01 877		MITSUBISHI	Colt, Lancer, Lancer Sedan, Lancer Station Wagon
		PROTON	Wira Aeroback
F 026 A01 880		MITSUBISHI	Lancer, Lancer Station Wagon
F 026 A01 882		MITSUBISHI	Pajero
F 026 A01 888		TOYOTA	Land Cruiser
F 026 A01 889		TOYOTA	Dyna 100, Dyna 150
F 026 A01 890		TOYOTA	Previa, Tarago
F 026 A01 893		MITSUBISHI	Pajero
F 026 A01 896		TOYOTA	Land Cruiser, Land Cruiser Prado, 4-Runner
F 026 A01 897		TOYOTA	Land Cruiser, Land Cruiser Prado
F 026 A01 899		TOYOTA	Dyna
F 026 A01 905		MITSUBISHI	Carisma, Carisma Hatchback, Colt, Lancer, Lancer Evo4, Lancer Evo5/6, Lancer Sedan, Lancer Station Wagon
F 026 A01 908		LAND ROVER GROUP	Discovery I, Range Rover II
F 026 A01 909		HONDA	Accord, Accord Coupé, Accord Hatchback, Accord Sedan
F 026 A01 910		MAZDA	323, 323 Hatchback

			
F 026 A01 913		NISSAN	Sunny Neo
F 026 A01 916		NISSAN	Pickup
F 026 A01 919		TOYOTA	Hilux, Hilux Pickup, Land Cruiser, Land Cruiser Prado, 4-Runner
F 026 A01 920		SUBARU	Forester
F 026 A01 922		MITSUBISHI	L 300 Truck, L 300 Van, L 300 Wagon
F 026 A01 923		MITSUBISHI	Lancer
F 026 A01 925		FORD	Econovan
F 026 A01 928		HONDA	CR-V
F 026 A01 929		MITSUBISHI	L 400, Space Gear
F 026 A01 930		HYUNDAI	Coupé, Elantra, Elantra Hatchback
F 026 A01 931		TOYOTA	Echo, Probox Van, Succeed Van, Vitz, Yaris, Yaris Verso
F 026 A01 933		SUBARU	Forester, Legacy, Legacy Kombi, Legacy Outback
F 026 A01 934		SUBARU	Forester
F 026 A05 ...			
F 026 A05 922		BMW	Serie 3
F 026 A05 936		TOYOTA	Camry
F 026 A05 939		MITSUBISHI	Lancer, Lancer Station Wagon, Outlander
F 026 A05 940		NISSAN	Pickup
F 026 A05 941		TOYOTA	Celica Cabrio, Celica Liftback
F 026 A05 942		SUZUKI	Liana Sedan
F 026 A05 944		NISSAN	Almera Hatchback, Almera Sedan, Sunny Neo, X-Trail
F 026 A05 945		HONDA	Jazz
F 026 A05 946		HONDA	Fit, Jazz
F 026 A05 948		TOYOTA	Corolla, Corolla Altis, Corolla Fielder, Corolla Hatchback, Corolla RunX, Corolla Sedan, Corolla Verso, Corolla Wagon
F 026 A05 953		TOYOTA	Land Cruiser
F 026 A05 954		TOYOTA	Land Cruiser
F 026 A05 957		CHEVROLET	Lanos
		DAEWOO	Lanos, Lanos Hatchback
F 026 A05 958		TOYOTA	RAV4, Urban Cruiser, Verso-S, Yaris
F 026 A05 959		TOYOTA	RAV4

de

**Kupplungs-
geberzylinder**
(Fortsetzung)

nl

**Koppelings-
gevercilinder**
(vervolg)

en

**Clutch sensor
cylinder**
(continued)

sv

**Kopplings-
cylinder**
(fortsättning)

fr

**Cylindre émetteur
d'embrayage**
(suite)

pt

**Cilindro sensor
da embraiagem**
(continuação)

it

Pompa frizione
(seguito)

cs

**Hlavní
válec spojky**
(pokračování)

es

**Cilindro principal
de embrague**
(continuación)

ru

**Цилиндр датчика
сцепления**
(продолжение)



F 026 A06 ...

F 026 A06 028	MITSUBISHI	L 300 Truck, L 300 Van, L 300 Wagon
F 026 A06 508	TOYOTA	Auris, Corolla
F 026 A06 512	SUZUKI	Escudo, Grand Vitara
F 026 A06 894	DAEWOO	Nubira, Nubira Station Wagon
F 026 A06 898	TOYOTA	Hiace, Quantum
F 026 A06 899	TOYOTA	Dyna
F 026 A06 900	NISSAN	Patrol GR, Safari
F 026 A06 901	SUBARU	Forester, Impreza Kombi, Impreza Sedan, Impreza STI Sedan
F 026 A06 905	TOYOTA	Fortuner, Hilux
F 026 A06 906	HOLDEN	Rodeo
F 026 A06 907	TOYOTA	Fortuner
F 026 A06 908	MITSUBISHI	L 200, L 200 Forte
F 026 A06 909	SUBARU	Legacy, Legacy Kombi
F 026 A06 913	HYUNDAI	Sonata
F 026 A06 925	HOLDEN	Jackaroo
F 026 A06 926	TOYOTA	Camry
F 026 A06 927	MITSUBISHI	Pajero

F 026 A07 ...

F 026 A07 097	TOYOTA	Hiace, Hiace Van
F 026 A07 099	TOYOTA	Dyna, Dyna 100, Dyna 150
F 026 A07 181	MAZDA	323, 323 Hatchback
F 026 A07 183	MITSUBISHI	Pajero, Pajero Cabrio
F 026 A07 517	SUBARU	Forester, Impreza Kombi, Impreza Outback, Impreza Sedan
F 026 A07 562	MAZDA	MX-5
F 026 A07 571	HONDA	Accord Sedan
F 026 A07 580	TOYOTA	Land Cruiser
F 026 A07 585	TOYOTA	RAV4, RAV4 Cabrio
F 026 A07 589	NISSAN	Patrol GR
F 026 A07 594	MITSUBISHI	Lancer Hatchback
F 026 A07 595	MITSUBISHI	Lancer Hatchback
F 026 A07 603	TOYOTA	Hilux Wagon
F 026 A07 611	NISSAN	Patrol GR
F 026 A07 613	TOYOTA	Hilux, Hilux Pickup
F 026 A07 614	MAZDA	323 Hatchback
F 026 A07 615	MAZDA	Tribute
F 026 A07 624	MAZDA	6, 6 Fastback, 6 Sedan, 6 Wagon

F 026 A09 ...

F 026 A09 609	HYUNDAI	Accent, Accent Hatchback
	KIA	Rio, Rio Hatchback

F 026 A09 616		TOYOTA	Camry, Celica Coupé, Corolla, Corolla Altis, Corolla Hatchback, Corolla Sedan, Corolla Verso, Corolla Wagon
F 026 A09 617		HYUNDAI	Getz
F 026 A09 618		TOYOTA	Starlet
F 026 A09 620		MAZDA	BT-50
F 026 A09 637		HONDA	FR-V, Jazz

F 026 005 ...

F 026 005 080	19	ALFA ROMEO	33 Berlina, 33 Sportwagon
F 026 005 091	19	ALFA ROMEO FIAT	155 Coupé
F 026 005 092	19	ALFA ROMEO FIAT	GTV, Spider, 145, 146, 155, 156 Berlina, 156 Sport Wagon, 156 Sport Wagon Q4 Brava, Bravo, Coupé, Marea, Marengo, Tempra, Tempra SW, Tipo
F 026 005 094	19	ALFA ROMEO	145, 146
F 026 005 095	19	ALFA ROMEO FIAT LANCIA	GTV, Spider, 145, 146, 155 Brava, Bravo, Coupé, Marea, Marengo, Tempra SW, Tipo Dedra Berlina, Dedra Station Wagon, Delta
F 026 005 119	19	ALFA ROMEO FIAT LANCIA	156 Berlina, 156 Sport Wagon, 156 Sport Wagon Q4 Brava, Bravo, Marela, Marengo Lybra Berlina, Lybra Station Wagon

de Kupplungs- nehmerzylinder	en Clutch slave cylinder	fr Cylindre récepteur d'embrayage	it Cilindro frizione	es Cilindro receptor de embrague
nl Koppelings- nemerzylinder	sv Kopplingscylinder slav	pt Cilindro servo da embraagem	cs Pracovní válec spojky	ru Вспомогательный цилиндр приемника сцепления

**0 204 163 ...**

0 204 163 020		PEUGEOT	P 4
0 204 163 025		RENAULT	Espace II, 21
0 204 163 055		NISSAN	Trade
0 204 163 074		ALFA ROMEO	155
0 204 163 077		ALFA ROMEO	155, 166
		FIAT	Coupé, Croma, Marea
		LANCIA	Delta, Kappa Berlina, Kappa Coupé, Kappa Station Wagon, Lybra Berlina, Lybra Station Wagon
0 204 163 078		ALFA ROMEO	145, 146
0 204 163 079		ALFA ROMEO	164
0 204 163 080		FIAT	Croma, Marengo, Tempra, Tempra SW, Tipo, Uno, Uno Van

0 986 AB8 ...

0 986 AB8 823	19,05	TOYOTA	Hilux Pickup
0 986 AB8 824	20,64	TOYOTA	Hilux Pickup

0 986 486 ...

0 986 486 500	20,64	BMW	Serie 3 Touring
0 986 486 503	23,81	MERCEDES-BENZ	Serie C, Serie E, Serie E (Cabrio), Serie E (Coupé), Serie E (T-Modell), Serie 190
0 986 486 504	25,4	ALFA ROMEO	Spider
0 986 486 509	22,2	LAND ROVER GROUP	Defender 90, Defender 110, Defender 130
0 986 486 514	20,6	TOYOTA	Corolla, Corolla Hatchback, Corolla Liftback, Corolla Sedan, Corolla Wagon
0 986 486 519	20,6	TOYOTA	Avensis, Avensis Liftback, Avensis Verso, Avensis Wagon, Carina E Liftback, Carina E Sedan, Carina E Wagon, Corolla, Corolla Hatchback, Corolla Liftback, Corolla Sedan, Corolla Verso, Corolla Wagon, Previa, RAV4
0 986 486 524	19	HONDA	Accord Sedan
		ROVER	Serie 600

0 986 486 532	22,2	AUDI	A6, A6 Avant, A8, Cabriolet, Coupé, Coupé S2, S4, S6, S6 Avant, 80, 80 Avant, 100, 100 Avant
0 986 486 533	20,64	BMW	Serie Z, Serie Z Coupé, Serie 3, Serie 3 Cabrio, Serie 3 Compact, Serie 3 Coupé, Serie 3 Touring
0 986 486 534	22,2	BMW	Serie X, Serie Z, Serie Z Coupé, Serie 1, Serie 3, Serie 3 Cabrio, Serie 3 Compact, Serie 3 Coupé, Serie 3 Touring, Serie 5, Serie 5 Touring, Serie 6, Serie 6 Cabrio, Serie 7
0 986 486 535	23,81	MERCEDES-BENZ	Serie C, Serie C (T-Modell), Serie CLK (Cabrio), Serie CLK (Coupé), Serie E, Serie E (Cabrio), Serie E (Coupé), Serie E (T-Modell), Serie G, Serie ML, Serie S, Serie SL, Serie SLK
0 986 486 537	23,8	SEAT	Cordoba, Cordoba Vario, Ibiza, Toledo
		VW (VOLKSWAGEN)	Caddy, California T4, Caravelle T4, Corrado, Golf III, Golf III Cabriolet, Golf III Variant, Golf IV Cabriolet, Kombi, Multivan T4, Passat, Passat Variant, Polo Classic, Polo Variant, Transporter T4, Vento

de

**Kupplungs-
nehmerzylinder**
(Fortsetzung)

en

**Clutch slave
cylinder**
(continued)

fr

**Cylindre récepteur
d'embrayage**
(suite)

it

**Cilindro
frizione**
(seguito)

es

**Cilindro receptor
de embrague**
(continuación)



0 986 486 538	19		AUDI	A3, S3, TT Coupé, TT Roadster
			SEAT	Cordoba, Cordoba Vario, Ibiza, Leon, Leon Cupra, Leon Cupra R, Toledo
			SKODA	Octavia, Octavia Combi
			VW (VOLKSWAGEN)	Bora, Caddy, Jetta, Jetta IV, Kombi, New Beetle, New Beetle Cabriolet, Transporter T4
0 986 486 539	22,2		BMW	Serie 7
0 986 486 542	23,81		AUDI	A3, S3
			SEAT	Cordoba, Cordoba Vario, Ibiza, Inca, Leon, Leon Cupra, Leon Cupra R, Toledo
			SKODA	Octavia, Octavia Combi
			VW (VOLKSWAGEN)	Bora, Bora Variant, Caddy, Golf, Golf IV, Golf IV Station Wagon, Golf IV Variant, Jetta IV, Polo Classic, Polo Variant
0 986 486 544	22,2		MERCEDES-BENZ	Serie V, Vito
0 986 486 546	22,2		MERCEDES-BENZ	Sprinter
			VW (VOLKSWAGEN)	LT
0 986 486 547	23,81		MERCEDES-BENZ	Serie G, 2t, 3t, 4t
0 986 486 548	22,2		AUDI	A4, A4 Avant, A4 Cabriolet, A6, A6 Allroad, A6 Avant, A8, RS4 Avant, S4, S4 Avant, S4 Cabriolet, S6, S6 Avant
			PORSCHE	Boxster, Cayman
			SKODA	Superb
			VW (VOLKSWAGEN)	Passat, Passat Variant
			VOLVO	740
0 986 486 549	20,64		VOLVO	740
0 986 486 550	22		VOLVO	S70, V70 I, 850, 850 Kombi

0 986 486 551	22,2		AUDI	A4, A4 Avant, A6
			VW (VOLKSWAGEN)	Passat, Passat Variant
0 986 486 552	22		BMW	Serie X, Serie Z, Serie Z Coupé, Serie 3, Serie 3 Cabrio, Serie 3 Compact, Serie 3 Coupé, Serie 3 Touring
0 986 486 553	19,05		AUDI	A1, A1 Sportback, A2
			SEAT	Cordoba, Ibiza, Ibiza SC, Ibiza ST, Toledo
			SKODA	Fabia, Fabia Combi, Fabia RS, Fabia Schrägheck, Praktik, Rapid, Rapid Spaceback, Roomster
0 986 486 554	19,05		VW (VOLKSWAGEN)	Polo
			AUDI	A1, A1 Sportback, A3, A3 Cabriolet, A3 Limousine, A3 Sportback, S3, S3 Cabriolet, S3 Limousine, S3 Sportback
0 986 486 554	19,05		SEAT	Altea, Altea Freetrack, Altea XL, Cordoba, Ibiza, Ibiza SC, Ibiza ST, Leon, Leon Cupra, Leon Cupra SC, Leon SC, Leon ST, Leon ST Cupra, Toledo
			SKODA	Fabia, Fabia Combi, Fabia RS, Fabia Schrägheck, Octavia, Octavia Combi, Octavia RS Combi, Praktik, Rapid, Rapid Spaceback, Roomster, Superb, Superb Combi, Yeti

nl

**Koppelings-
nemercilinder**
(vervolg)

sv

**Kopplingscylinder
slav**
(fortsättning)

pt







**Cilindro servo
da embraiagem**
(continuação)

cs

**Pracovní válec
spojky**
(pokračování)

ru

**Вспомогательный
цилиндр приемника
сцепления**
(продолжение)

									
0 986 486 554	19,05	VW (VOLKSWAGEN)	Beetle, Beetle Cabriolet, Bora, Bora Variant, Caddy, Caddy Panel Van, Eos, Golf IV, Golf IV Station Wagon, Golf IV Variant, Golf Plus, Golf Sportsvan, Golf V, Golf V Variant, Golf VI, Golf VI Cabriolet, Golf VI Variant, Golf VII, Golf VII Variant, Jetta, Lupo, New Beetle, New Beetle Cabriolet, Passat, Passat Variant, Polo, Polo Limousine, Polo Sedan, Polo Vivo, Scirocco, Touran	0 986 486 569	22,2	TOYOTA	Corolla, Corolla Hatchback, Corolla Liftback, Corolla Sedan, Corolla Wagon, Starlet		
			0 986 486 573				20,6	ALFA ROMEO	GT, 147
			0 986 486 576				19	AUDI	A3, A3 Sportback
								SEAT	Altea, Altea Freetrack, Altea XL, Leon, Leon SC, Toledo
			SKODA				Octavia, Octavia Combi, Yeti		
VW (VOLKSWAGEN)	Beetle, Bora, Bora Variant, Caddy, Caddy Panel Van, California T4, Caravelle T4, CC, Eos, Eurovan, Golf IV, Golf IV Cabriolet, Golf IV Station Wagon, Golf IV Variant, Golf Plus, Golf V, Golf V Variant, Golf VI, Golf VI Cabriolet, Golf VI Variant, Golf VII, Jetta, Kombi, Lupo, Multivan T4, New Beetle, New Beetle Cabriolet, Passat, Passat Alltrack, Passat CC, Passat Variant, Polo, Polo Classic, Polo Variant, Scirocco, Touran, Transporter T4								
0 986 486 555	19	HONDA	Civic, Civic Aerodeck, Civic Coupé, Civic CRX, Civic Fastback, Civic Hatchback, Civic Sedan, Civic Sedan, CR-V, HR-V, Integra Type R	0 986 486 577	19,05	SKODA	Fabia, Fabia Combi, Fabia Schrägheck, Octavia		
			0 986 486 556				20,6	ALFA ROMEO	MiTo, 147
0 986 486 563	20,6	FIAT	Albea, Doblo, Doblo Cargo, Fiorino, Grande Punto, Idea, Linea, Multipla, Palio, Punto, Punto Evo, Punto Grande, Punto Van, Qubo, Stilo, Stilo Multi Wagon, Strada	0 986 486 579	34	ALFA ROMEO	Brera, Spider, 159 Berlina, 159 Berlina Q4, 159 Sport Wagon, 159 Sport Wagon Q4		
			LANCIA				Musa, Ypsilon		
		LANCIA	Ypsilon						

de

**Kupplungs-
nehmerzylinder**
(Fortsetzung)

en

**Clutch slave
cylinder**
(continued)

fr

**Cylindre récepteur
d'embrayage**
(suite)

it

**Cilindro
frizione**
(seguito)

es

**Cilindro receptor
de embrague**
(continuación)



0 986 486 579	34		CHEVROLET	Captiva
			OPEL	Antara, Signum, Vectra
			SAAB (SAAB AUTOMOBILE AB)	9-3, 9-3 Cabriolet, 9-3 Kombi, 9-3X
			VAUXHALL	Antara, Signum
0 986 486 580	19		MAZDA	MX-5
0 986 486 582	23,81		MINI (BMW)	Cooper, Cooper Cabrio, Cooper One, Cooper S, John Cooper Works, John Cooper Works Cabrio
0 986 486 583	22,2		AUDI	A4, A4 Avant, A4 Cabriolet, RS4, RS4 Avant, RS4 Cabriolet, S4, S4 Avant, S4 Cabriolet
			SEAT	Exeo, Exeo ST
0 986 486 584	31		OPEL	Astra, Astra Caravan, Astra GTC, Astra TwinTop, Combo, Corsa, Tigra TwinTop
			VAUXHALL	Astra, Astra Estate, Astra GTC, Astra TwinTop, Combo, Corsa
0 986 486 585	34		OPEL	Astra, Astra Caravan, Sintra
			SAAB (SAAB AUTOMOBILE AB)	9-3, 9-3 Cabriolet, 9-3 Coupé, 9-5, 9-5 Kombi
0 986 486 586	34		FIAT	Croma
			SAAB (SAAB AUTOMOBILE AB)	9-5, 9-5 Kombi
			VAUXHALL	Astra, Astra Convertible, Astra Coupé, Astra Estate, Astra Van, Vectra, Vectra Estate, Zafira
0 986 486 587	26		MERCEDES-BENZ	Classe A, Serie A, Serie B, Vaneo
0 986 486 588	31		ALFA ROMEO	159 Berlina, 159 Sportwagon
			CHEVROLET	Aveo, Aveo Hatchback, Cruze, Cruze Hatchback, Cruze Station Wagon

0 986 486 588	31		FIAT	Croma
			OPEL	Adam, Astra, Astra Cabrio, Astra Caravan, Astra Coupé, Astra GTC, Astra Limousine, Astra Sporte Tourer, Astra Sports Tourer, Astra TwinTop, Combo, Corsa, Meriva, Signum, Tigra TwinTop, Vectra, Vectra Caravan, Zafira
			SAAB (SAAB AUTOMOBILE AB)	9-3, 9-3 Kombi
			SUZUKI	Swift Hatchback
0 986 486 589	34		VAUXHALL	Adam, Astra, Astra Convertible, Astra Coupé, Astra Estate, Astra GTC, Astra Sport Tourer, Astra Sports Tourer, Astra TwinTop, Astra Van, Combo, Corsa, Meriva, Signum, Tigra TwinTop, Vectra, Vectra Estate, Zafira
			ALFA ROMEO	Brera, Spider
			FIAT	Linea, Punto, Punto Evo, Punto Grande
0 986 486 590	34		OPEL	Astra, Astra Caravan, Astra GTC, Astra TwinTop, Corsa
			VAUXHALL	Astra, Astra Estate, Astra GTC, Astra TwinTop, Corsa
0 986 486 590	34		CHEVROLET	Trax
			FIAT	Linea, Punto Evo, Punto Grande
			OPEL	Astra, Astra Caravan, Astra GTC, Astra TwinTop, Meriva, Mokka, Zafira
0 986 486 590	34		VAUXHALL	Astra, Astra Estate, Astra GTC, Astra TwinTop, Meriva, Mokka, Zafira

nl

**Koppelings-
nemercilinder**
(vervolg)

sv

Kopplingscylinder
slav
(fortsättning)

pt







Cilindro servo
da embraiagem
(continuação)

cs

Pracovní válec
spojky
(pokračování)

ru

Вспомогательный
цилиндр приемника
сцепления
(продолжение)

  				  			
0 986 486 591	34	ALFA ROMEO	Brera, Spider, 159 Berlina	0 986 486 595	29	VW (VOLKSWAGEN)	Beetle, Beetle Cabriolet, Caddy, California T5, California T6, Caravelle T5, Caravelle T6, CC, Eos, Golf IV, Golf IV Variant, Golf Plus, Golf V, Golf V Variant, Golf VI, Golf VI Variant, Jetta, Multivan T5, Multivan T6, New Beetle, Passat, Passat Alltrack, Passat CC, Passat Variant, Polo, Scirocco, Scirocco R, Sharan, Tiguan, Touran, Transporter T5, Transporter T6
		CHEVROLET	Aveo, Aveo Hatchback, Trax				
		FIAT	Punto Evo, Punto Grande				
		OPEL	Astra, Astra Caravan, Astra GTC, Astra TwinTop, Corsa, Meriva, Mokka, Zafira				
		VAUXHALL	Astra, Astra Estate, Astra GTC, Astra TwinTop, Corsa, Meriva, Mokka, Zafira				
0 986 486 592	34	ALFA ROMEO	159 Berlina	0 986 486 596	27	OPEL	Movano
		FIAT	Croma, Punto Grande Abarth, Punto Grande Abarth SS			RENAULT	Espace IV, Master, Master I, Master II, Trafic II
0 986 486 593	34	OPEL	Astra, Astra Caravan, Vectra, Vectra Caravan, Zafira	0 986 486 597	20,64	FIAT	Idea, Panda, Panda Cross, Punto, Punto Van, 500, 500C
		VAUXHALL	Astra, Astra Estate, Astra Van, Vectra, Vectra Estate, Zafira			LANCIA	Musa, Ypsilon
0 986 486 594	34	OPEL	Astra, Astra Caravan, Astra GTC, Corsa, Zafira	0 986 486 602	19,05	HONDA	City, City Sedan, Civic Hatchback, Civic Sedan, CR-Z, Jazz
VAUXHALL	Astra, Astra Estate, Corsa, Zafira						
0 986 486 595	29	AUDI	A3, A3 Cabriolet, A3 Sportback, Q3, S3, S3 Sportback, TT Coupé, TT Roadster, TT RS Coupé, TT RS Roadster, TTS Coupé, TTS Roadster	0 986 486 603	19	HONDA	Accord, Accord Tourer, Civic Hatchback, CR-V, FR-V, Stream
		FORD	Galaxy				
		SEAT	Alhambra, Altea, Altea Freetrack, Altea XL, Cordoba, Ibiza, Ibiza SC, Ibiza ST, Leon, Leon Cupra, Leon Cupra R, Toledo				
		SKODA	Fabia Schrägheck, Octavia, Octavia Combi, Superb, Superb Combi, Yeti				
0 986 486 605	20,6	HYUNDAI	Coupé, Getz	0 986 486 607	22,2	BMW	Serie X, Serie Z, Serie 1, Serie 1 Cabrio, Serie 1 Coupé, Serie 3, Serie 3 Cabrio, Serie 3 Coupé, Serie 3 Touring, Serie 5, Serie 5 Touring, Serie 6, Serie 6 Cabrio

de

**Kupplungs-
nehmerzylinder**
(Fortsetzung)

en

**Clutch slave
cylinder**
(continued)

fr

**Cylindre récepteur
d'embrayage**
(suite)

it

**Cilindro
frizione**
(seguito)

es

**Cilindro receptor
de embrague**
(continuación)



0 986 486 610	31		FORD	Mondeo III, Mondeo III Turnier
			JAGUAR	X-Type, X-Type Estate
0 986 486 611	28		FORD	C-MAX, Focus C-MAX, Focus II, Focus II Cabriolet, Focus II Turnier, Mondeo IV, Mondeo IV Turnier
			VOLVO	C30, S40 II, V50
0 986 486 612	28		FORD	Ranger, Transit
0 986 486 613	36		MERCEDES-BENZ	Serie V, Vito
0 986 486 614	23		CHEVROLET	Lacetti, Nubira, Nubira Wagon, Optra Hatchback
			RENAULT	Grand Scenic III, Megane III CC, Megane III Coupé, Megane III Grandtour, Megane III Hatchback, Scenic III
0 986 486 615	30		CITROEN	Berlingo, C4, C4 Coupé, C4 Grand Picasso, C4 Picasso, C5, C5 Tourer
			PEUGEOT	Partner, RCZ, 308, 308 CC, 308 SW, 407, 407 Coupé, 407 SW, 3008, 5008
F 026 A02 ...				
F 026 A02 402			TOYOTA	Corolla, Corolla Fielder, Echo, Limo, Probox Van, Succeed Van, Vitz, Yaris, Yaris Verso
F 026 A02 489			NISSAN	Urvan
F 026 A02 515			TOYOTA	Dyna, Dyna 100, Hilux, Hilux Pickup, Land Cruiser
			NISSAN	Cedric Sedan
F 026 A02 517			FORD	Econovan
F 026 A02 522			MAZDA	Serie B
F 026 A02 523			TOYOTA	Land Cruiser
F 026 A02 524			FORD	Econovan
			MAZDA	E-Serie
F 026 A02 533			FORD	Courier
			MAZDA	Serie B

F 026 A02 537			FORD	Probe
			MAZDA	MPV, MX-6, Xedos-9, 323 Astina Hatchback, 323 Sedan, 626, 626 Fastback, 626 Hatchback, 626 Wagon
F 026 A02 539			TOYOTA	Land Cruiser
F 026 A02 541			NISSAN	Urvan
F 026 A02 543			HYUNDAI	Elantra, Lantra
F 026 A02 545			MAZDA	Premacy, 323, 323 Hatchback, 626, 626 Fastback, 626 Hatchback, 626 Wagon
			TOYOTA	Land Cruiser
F 026 A02 549			TOYOTA	Land Cruiser
F 026 A02 550			TOYOTA	Land Cruiser
F 026 A02 551			TOYOTA	Hiace, Hiace Van, Hiace Wagon
			TOYOTA	Avensis, Avensis Liftback, Avensis Wagon, Carina E Liftback, Carina E Sedan, Carina E Wagon, Celica Liftback, Corolla, Corolla Hatchback, Corolla Liftback, Corolla Sedan, Corolla Wagon
F 026 A02 552			TOYOTA	Hilux Wagon
F 026 A02 560			TOYOTA	Hilux Wagon
F 026 A02 562			DAEWOO	Espero, Nubira, Nubira Station Wagon
			HYUNDAI	Accent, Accent Hatchback, Excel, Excel Hatchback, Pony
F 026 A02 563			HYUNDAI	Accent, Accent Hatchback, Excel, Excel Hatchback, Pony
			NISSAN	Urvan
F 026 A02 565			NISSAN	Urvan
			TOYOTA	Dyna, Dyna 100, Hilux, Hilux Pickup, Land Cruiser
F 026 A02 565			TOYOTA	Dyna, Dyna 100, Hilux, Hilux Pickup, Land Cruiser
			NISSAN	Cedric Sedan
F 026 A02 568			HYUNDAI	Coupé, Elantra, Lantra, Lantra Kombi
			TOYOTA	Hilux, Hilux Pickup
F 026 A02 570			TOYOTA	Hilux, Hilux Pickup
F 026 A02 573			KIA	Mentor II, Mentor II Hatchback, Spectra Hatchback
			NISSAN	Urvan
F 026 A02 576			NISSAN	Urvan
F 026 A02 578			NISSAN	Urvan
			NISSAN	Urvan

nl

**Koppelings-
nemer cilinder**
(vervolg)

sv

**Kopplingscylinder
slav**
(fortsättning)

pt

**Cilindro servo
da embraiagem**
(continuação)

cs

**Pracovní válec
spojky**
(pokračování)

ru

**Вспомогательный
цилиндр приемника
сцепления**
(продолжение)



F 026 A02 579	MITSUBISHI	L 200, L 300 Truck
F 026 A02 580	MITSUBISHI	Pajero
F 026 A02 582	MITSUBISHI	Pajero
F 026 A02 586	NISSAN	Patrol GR, Safari
F 026 A02 587	NISSAN	Patrol GR
F 026 A02 589	TOYOTA	Land Cruiser, Land Cruiser Prado, 4-Runner
F 026 A02 590	TOYOTA	Avensis, Avensis Liftback, Avensis Wagon, Camry, Carina E Liftback, Carina E Sedan, Carina E Wagon, Corolla, Corolla Hatchback, Corolla Liftback, Corolla Wagon
F 026 A02 591	TOYOTA	Dyna
F 026 A02 593	TOYOTA	Auris, Avensis, Avensis Liftback, Avensis Wagon, Corolla, Corolla Altis, Corolla Hatchback, Corolla Liftback, Corolla RunX, Corolla Sedan, Corolla Verso, Corolla Wagon
F 026 A02 594	NISSAN	Altima, Primera, Primera Hatchback, Primera Wagon, X-Trail
F 026 A02 597	NISSAN	Pickup, Terrano II
F 026 A02 598	NISSAN	Pathfinder, Pickup
F 026 A02 599	NISSAN	Pickup
F 026 A02 601	SUBARU	Forester, Impreza Kombi, Impreza Outback, Impreza Sedan, Legacy Kombi
F 026 A02 604	MAZDA	Premacy, 323, 323 Hatchback
F 026 A02 605	MAZDA	6, 6 Fastback, 6 Sedan, 6 Wagon
F 026 A02 606	MITSUBISHI	Lancer EvoX, Lancer Evo4, Lancer Evo5/6, Lancer Evo7, Lancer Evo8, Lancer Evo9



F 026 A02 607	MITSUBISHI	Pajero
F 026 A02 609	NISSAN	Almera Hatchback, Almera Sedan, Almera Tino, Primera Hatchback, Primera Sedan, Primera Wagon, Pulsar, Sunny Neo
F 026 A02 610	MITSUBISHI	L 300 Truck, L 300 Van, L 300 Wagon, L 400, Space Gear
F 026 A02 612	SUZUKI	Escudo, Grand Vitara, Grand Vitara Cabrio
F 026 A06 ...		
F 026 A06 029	TOYOTA	Fortuner, Hilux
F 026 A06 031	TOYOTA	Avensis, Avensis Liftback, Avensis Wagon
F 026 A06 033	FORD	Cougar, Galaxy, Mondeo I, Mondeo I Turnier, Mondeo III, Mondeo III Turnier
F 026 A06 034	SUBARU	Forester
F 026 A06 041	TOYOTA	Camry, Previa
F 026 A06 042	TOYOTA	Dyna 100, Dyna 150, Hiace, Land Cruiser, 4-Runner
F 026 A06 043	TOYOTA	Avensis, Avensis Liftback, Avensis Verso, Avensis Wagon, Camry, RAV4
F 026 A06 044	TOYOTA	Land Cruiser
F 026 A06 046	TOYOTA	Land Cruiser
F 026 A06 047	MITSUBISHI	Carisma, Carisma Hatchback, Colt, Galant, Galant Station Wagon, Lancer, Lancer Sedan, Outlander, Space Runner, Space Wagon, Spacestar
F 026 A06 048	HONDA	City New, Fit, Jazz
F 026 A06 055	CHEVROLET	Evanda, Lanos, Rezzo
	DAEWOO	Espero, Evanda, Lanos, Lanos Hatchback, Nexia, Nexia Hatchback



de

**Kupplungs-
nehmerzylinder**
(Fortsetzung)

en

**Clutch slave
cylinder**
(continued)

fr

**Cylindre récepteur
d'embrayage**
(suite)

it

**Cilindro
frizione**
(seguito)

es

**Cilindro receptor
de embrague**
(continuación)



F 026 A06 056			MITSUBISHI Carisma, Carisma Hatchback, Colt, Galant, Galant Station Wagon, Grandis, Lancer, Lancer Sportback, Lancer Station Wagon, Outlander, Space Runner, Space Wagon, Spacestar
F 026 A06 057			MITSUBISHI Pajero
F 026 A06 205			TOYOTA Avensis, Avensis Liftback, Avensis Wagon, Carina E Liftback, Carina E Sedan, Carina E Wagon, Celica Liftback, Picnic, RAV4
F 026 A06 568			FORD Ranger, Transit
F 026 A06 570			TOYOTA Auris, Corolla
F 026 A06 571			TOYOTA Vitz, Yaris
F 026 A06 573			NISSAN Pickup
F 026 A06 577			SUZUKI Grand Vitara, Jimny, Vitara
F 026 A06 716			TOYOTA Dyna
F 026 A06 931			BMW Serie 5, Serie 5 Touring
F 026 A06 933			MAZDA BT-50
F 026 A06 936			TOYOTA Hiace, Hilux Wagon, Land Cruiser, Quantum
F 026 A06 941			SUBARU Forester, Impreza Kombi, Impreza Sedan
F 026 A06 942			TOYOTA Fortuner
F 026 A06 948			HYUNDAI Coupé, Elantra, Elantra Hatchback, ix35, Matrix, Santa Fe, Santa Fe, Sonata, Trajet, Tucson, XG
			KIA Carens, Cerato, Cerato Hatchback, Magentis, Sportage
F 026 A06 949			HONDA Accord Coupé, Prelude
F 026 A07 ...			
F 026 A07 098			TOYOTA Hiace
F 026 A07 633			TOYOTA Celica Coupé, MR2 Cabrio, RAV4

F 026 A07 634			NISSAN Patrol GR
F 026 A07 638			SUBARU Forester, Impreza, Impreza Kombi, Impreza Outback, Impreza Sedan, Legacy, Legacy Kombi, Legacy Outback, XV
F 026 A07 689			TOYOTA Hilux
F 026 A07 694			MAZDA 323, 323 Astina, 323 Astina Hatchback, 323 Hatchback
F 026 A07 695			MAZDA RX-7 Coupé
F 026 A07 697			TOYOTA Camry, Camry Wagon
F 026 A07 700			TOYOTA Estima Emína, Estima Lucida, Previa, Tarago
F 026 A07 701			SUZUKI Baleno Hatchback, Baleno Sedan, Baleno Wagon, Liana Hatchback, Liana Sedan, Swift Sedan
F 026 A07 703			NISSAN Patrol GR
F 026 A07 708			MITSUBISHI L 200, L 200 Forte, Pajero Sport
F 026 A07 713			NISSAN Pickup
F 026 A07 715			MAZDA MPV, Premacy, 6 Fastback, 6 Sedan, 6 Wagon, 323, 323 Hatchback
F 026 A09 ...			
F 026 A09 427			TOYOTA Hiace
F 026 A09 571			HYUNDAI Accent, Accent blue, Accent Hatchback, Elantra, ix35, i20, i30, i30 Coupé, i30 CW, i40, i40 CW, Solaris, Solaris Hatchback, Sonata, Veloster
			KIA Carens, Cee'd, Cee'd Sporty Wagon, Cerato, Cerato Koup, Creato, Creato Koup, Optima, Pro Cee'd, Rio, Rio Hatchback, Sportage

de

Bremskraftregler

en

Load-sensing valve

fr

Correcteur
de freinage

it

Regolatore forza
frenante

es

Regulador de la fuerza
de frenado**0 204 0A2 ...****0 204 0A2 573** FORD Ranger**0 204 0A2 586** FORD Serie F**0 204 0C2 ...****0 204 0C2 335** FIAT Stilo**0 204 021 ...****0 204 021 150** IVECO Daily**0 204 031 ...****0 204 031 050** FIAT Ducato 10, Ducato 11, Ducato 14,
Ducato 15, Ducato 18**0 204 031 056** FIAT Ducato 10, Ducato 11, Ducato 14,
Ducato 15, Ducato 18, Talento**0 204 031 068** MERCEDES-
BENZ Sprinter**0 204 031 108** OPEL Corsa
VAUXHALL Corsa**0 204 031 109** PEUGEOT 206, 206 Sedan, 206 SW**0 204 031 110** PEUGEOT 206, 206+, 206 Sedan, 206 SW**0 204 031 119** IVECO Daily, Daily Chassi, Daily Furgao,
Daily MaxiVan**0 204 031 120** FIAT Multipla**0 204 031 174** OPEL Agila
VAUXHALL Agila**0 204 031 179** FIAT Punto Van**0 204 031 180** FIAT Punto, Punto Van**0 204 031 181** PEUGEOT 206 CC**0 204 031 182** CITROEN Jumper
FIAT Ducato 11, Ducato 15, Ducato 18
PEUGEOT Boxer**0 204 031 183** CITROEN Jumper
FIAT Ducato 15
PEUGEOT Boxer**0 204 031 184** CITROEN Jumper
FIAT Ducato 15
PEUGEOT Boxer**0 204 031 185** CITROEN Jumper
FIAT Ducato 18
PEUGEOT Boxer**0 204 031 186** MERCEDES-
BENZ Sprinter**0 204 031 187** MERCEDES-
BENZ Sprinter**0 204 031 199** FIAT Albea**0 204 031 202** CITROEN Jumper
FIAT Ducato 18
PEUGEOT Boxer**0 204 031 289** FORD Escort VII Express,
Escort V/VI Express**0 204 031 290** SEAT Inca
VW (VOLKS-
WAGEN) Caddy**0 204 031 294** FORD Fiesta III, Fiesta III Courier**0 204 031 295** RENAULT Megane I Grandtour,
Scenic, Scenic I**0 204 031 296** RENAULT Clio II, Clio II Sedan, Thalia**0 204 031 298** FORD Transit, Transit Euroline,
Transit Nugget, Transit Tourneo**0 204 031 299** FORD Transit, Transit Euroline,
Transit Nugget, Transit Tourneo**0 204 031 300** MERCEDES-
BENZ MB**0 204 031 306** RENAULT Kangoo I**0 204 031 307** RENAULT Kangoo I**0 204 031 308** RENAULT Master II**0 204 031 309** RENAULT Master II**0 204 031 310** RENAULT Master II**0 204 031 311** RENAULT Megane I Cabrio, Megane I Classic,
Megane I Coupé**0 204 031 312** RENAULT Megane I Coupé**0 204 031 313** RENAULT Megane, Megane I,
Megane I Cabrio,
Megane I Classic,
Megane I Coupé**0 204 031 314** RENAULT Megane, Megane I,
Megane I Cabrio,
Megane I Classic,
Megane I Coupé**0 204 031 318** FIAT Linea**0 204 031 329** RENAULT Megane I, Megane I Cabrio,
Megane I Classic,
Megane I Coupé**0 204 031 335** FIAT Doblo, Doblo Cargo**0 204 031 336** FIAT Doblo, Doblo Cargo**0 204 031 681** SEAT Ibiza, Ibiza SC
SKODA Fabia, Fabia Combi,
Fabia SchrägheckVW (VOLKS-
WAGEN) Polo**0 204 031 682** SEAT Ibiza, Ibiza SC

SKODA Fabia, Fabia Combi

VW (VOLKS-
WAGEN) Fox,
Polo**0 204 032 ...****0 204 032 828** FORD Courier**0 204 131 ...****0 204 131 028** RENAULT 11**0 204 131 029** DACIA Serie 1300**0 204 131 042** RENAULT 5**0 204 131 043** CITROEN AX**0 204 131 046** CITROEN AX, ZX**0 204 131 047** RENAULT 5**0 204 131 048** PEUGEOT 205, 306, 306 Cabriolet**0 204 131 049** PEUGEOT 205**0 204 131 052** PEUGEOT 205, 205 Pickup

nl

Remkrachtregelaar

sv

Bromsventil

pt

Regulador da força
de travagem

cs

Regulátor brzdné
síly

ru

Регулятор
тормозных сил

		
0 204 131 058	VW (VOLKS- WAGEN)	Passat, Passat Variant
0 204 131 062	RENAULT	Safrane
0 204 131 063	RENAULT	Safrane
0 204 131 064	PEUGEOT	205
0 204 131 065	CITROEN	AX
	PEUGEOT	106
0 204 131 067	PEUGEOT	306, 306 Cabriolet
0 204 131 068	CITROEN	ZX
0 204 131 069	PEUGEOT	306, 306 Cabriolet
0 204 131 082	CITROEN	Evasion
	FIAT	Ulysse
	LANCIA	Zeta
	PEUGEOT	806
0 204 131 084	CITROEN	Evasion
	FIAT	Ulysse
	PEUGEOT	806
0 204 131 085	CITROEN	Evasion, Jumpy
	FIAT	Scudo, Ulysse
	PEUGEOT	Expert, 806
0 204 131 086	PEUGEOT	205
0 204 131 092	CITROEN	Saxo
	PEUGEOT	106
0 204 131 093	CITROEN	Saxo
	PEUGEOT	106
0 204 131 094	RENAULT	Laguna I Grandtour
0 204 131 095	RENAULT	Laguna I Grandtour
0 204 131 139	RENAULT	Express, Extra, Rapid
0 204 131 140	RENAULT	5
0 204 131 142	NISSAN	Trade
0 204 131 146	RENAULT	Clio I
0 204 131 147	RENAULT	Clio I
0 204 131 150	RENAULT	Safrane
0 204 131 151	RENAULT	Safrane
0 204 131 153	RENAULT	Express, Extra, Rapid
0 204 131 154	RENAULT	Express, Extra, Rapid
0 204 131 162	RENAULT	19
0 204 131 164	RENAULT	19, 19 Cabrio
0 204 131 165	RENAULT	Laguna I
0 204 131 166	RENAULT	Laguna I
0 204 131 167	RENAULT	Laguna I
0 204 131 168	RENAULT	Laguna I
0 204 131 175	RENAULT	Laguna I Grandtour
0 204 131 176	RENAULT	Laguna I Grandtour
0 204 131 177	RENAULT	Twingo I
0 204 131 178	RENAULT	Clio I
0 204 131 183	RENAULT	19, 19 Cabrio
0 204 131 185	RENAULT	Laguna I Grandtour
0 204 131 188	RENAULT	Clio I
0 204 131 202	ALFA ROMEO	164
	FIAT	Croma, Fiorino, Strada
0 204 131 205	ALFA ROMEO	33 Berlina, 33 Sportwagon
0 204 131 212	LANCIA	Delta

		
0 204 131 217	CITROEN	Jumper
	FIAT	Ducato 14
	IVECO	Daily
	PEUGEOT	Boxer
0 204 131 221	ALFA ROMEO	155
	FIAT	Brava, Bravo, Coupé, Marea, Marengo, Multipla, Tempra, Tempra SW, Tipo
	LANCIA	Dedra Berlina, Dedra Station Wagon, Delta
0 204 131 223	AUTOBIAN- CHI	Y 10
	FIAT	Uno, Uno Van
0 204 131 226	AUTOBIAN- CHI	Y 10
	CITROEN	C 25
	LANCIA	Y 10
0 204 131 232	CITROEN	Jumper
	FIAT	Ducato 10, Ducato 11, Ducato 14, Ducato 15, Ducato 18
	PEUGEOT	Boxer
0 204 131 233	FIAT	Barchetta, Punto, Punto Cabrio, Punto GT, Punto Van, Seicento
0 204 131 234	FIAT	Barchetta, Punto, Punto Cabrio, Punto GT, Punto Van, Seicento
0 204 131 236	IVECO	Daily
0 204 131 248	MERCEDES- BENZ	Sprinter
	VW (VOLKS- WAGEN)	LT
0 204 131 249	MERCEDES- BENZ	Sprinter
	VW (VOLKS- WAGEN)	LT
0 204 131 250	MERCEDES- BENZ	Sprinter
	VW (VOLKS- WAGEN)	LT
0 204 131 251	MERCEDES- BENZ	Sprinter
	VW (VOLKS- WAGEN)	LT
0 204 131 256	CITROEN	ZX
	PEUGEOT	306
0 204 131 257	CITROEN	ZX
0 204 131 258	CITROEN	ZX
0 204 131 262	UMM (UNIAO METALO MECANICA)	Alter
0 204 131 265	FIAT	Punto Cabrio
0 204 131 266	FIAT	Punto Cabrio
0 204 131 268	CITROEN	Xsara, Xsara Break, Xsara Coupé
	PEUGEOT	306, 306 Break, 306 Cabriolet

de

Bremskraftregler
(Fortsetzung)

en

Load-sensing valve
(continued)

fr

Correcteur de freinage (suite)

it

Regolatore forza frenante (seguito)

es

Regulador de la fuerza de frenado (continuación)

nl

Remkrachtregelaar
(vervolg)

sv

Bromsventil
(fortsättning)

pt

Regulador da força de travagem (continuação)

cs

Regulátor brzdné síly (pokračování)

ru

Регулятор тормозных сил (продолжение)

0 204 131 269	CITROEN PEUGEOT	Xsara, Xsara Break, Xsara Coupé 306, 306 Break, 306 Cabriolet
0 204 131 270	CITROEN PEUGEOT	Xsara, Xsara Break, Xsara Coupé 306, 306 Break, 306 Cabriolet
0 204 131 271	PEUGEOT	306, 306 Break
0 204 131 272	CITROEN	Xsara, Xsara Break, Xsara Coupé
0 204 131 274	FIAT	Panda
0 204 131 284	RENAULT	Safrane
0 204 131 288	RENAULT	Espace II
0 204 131 290	RENAULT	Espace II
0 204 131 293	FIAT	Palio Weekend
0 204 131 298	NISSAN	Kubistar
0 204 131 322	MERCEDES- BENZ	Serie V, Vito
0 204 131 343	LANCIA	Kappa Coupé
0 204 131 354	FORD	Transit, Transit Euroline, Transit Nugget, Transit Tourneo
0 204 131 356	FORD	Transit, Transit Euroline, Transit Nugget, Transit Tourneo
0 204 131 358	FORD	Transit
0 204 131 359	FORD	Transit, Transit Euroline, Transit Nugget, Transit Tourneo
0 204 131 360	FORD	Transit, Transit Euroline, Transit Nugget, Transit Tourneo
0 204 131 362	FORD	Fiesta IV, Fiesta IV Courier
0 204 131 366	FORD	Transit
0 204 131 367	FORD	Transit, Transit Euroline, Transit Nugget, Transit Tourneo
0 204 131 368	FORD	Transit, Transit Euroline, Transit Nugget, Transit Tourneo
0 204 131 369	FORD	Transit
0 204 131 380	IVECO	Daily
0 204 131 387	RENAULT	Kangoo I, Kangoo II
0 204 131 388	RENAULT	Kangoo I
0 204 131 680	FORD	Transit
0 204 131 682	SEAT	Cordoba, Ibiza
0 204 131 697	SEAT	Cordoba, Cordoba Vario, Ibiza, Toledo
	VW (VOLKS- WAGEN)	Corrado, Golf III, Golf III Cabriolet, Golf III Variant, Golf IV Cabriolet, Polo Classic, Polo Variant, Vento
0 204 131 701	FORD	Transit
0 204 131 702	FORD	Transit, Transit Euroline, Transit Nugget, Transit Tourneo
0 204 131 703	FORD	Transit, Transit Euroline, Transit Nugget, Transit Tourneo
0 204 131 704	FORD	Transit, Transit Nugget
0 204 131 705	FORD	Transit, Transit Euroline, Transit Nugget, Transit Tourneo
0 204 131 706	FORD	Transit
0 204 131 707	FORD	Transit
0 204 131 708	FORD	Transit
0 204 131 709	FORD	Transit
0 204 131 710	FORD	Transit, Transit Euroline, Transit Nugget, Transit Tourneo



0 204 131 711	FORD	Transit, Transit Euroline, Transit Nugget, Transit Tourneo
0 204 131 714	FIAT	Panda
0 204 131 716	SEAT	Marbella
0 204 131 717	SEAT	Marbella
0 204 131 720	FIAT	Cinquecento, Seicento
0 986 482 ...		
0 986 482 002	RENAULT	Trafic
0 986 482 005	PEUGEOT	405, 405 Break
0 986 482 006	SEAT	Toledo
	VW (VOLKS- WAGEN)	Corrado, Golf III, Golf III Variant, Passat, Passat Variant, Polo, Polo Classic, Polo Coupé
0 986 482 007	SKODA	Felicia Fun, Octavia, Octavia Combi, Pick-Up
	VW (VOLKS- WAGEN)	Caddy Pickup, Golf Cabriolet, Golf III, Golf III Cabriolet, Golf III Variant, Lupo, Polo, Vento
0 986 482 008	AUDI	A6, A6 Avant, Cabriolet, Coupé, 100, 100 Avant
0 986 482 009	PEUGEOT	205
0 986 482 011	LAND RO- VER GROUP	Range Rover I, Range Rover II
0 986 482 012	ROVER	100 Metro, 100 Metro Cabrio
0 986 482 016	LAND RO- VER GROUP	Defender 110, Defender 130
0 986 482 017	ROVER	Mini, Mini Cabrio, Mini Cooper, Mini Cooper Cabrio, Mini De Ville, Mini De Ville Cabrio, Mini Margrave, Mini Retro Rally
0 986 482 029	CITROEN PEUGEOT	Berlingo Partner, Ranch
0 986 482 030	CITROEN PEUGEOT	Berlingo Partner, Ranch
0 986 482 031	CITROEN PEUGEOT	Berlingo, Xsara Picasso Partner, Ranch
0 986 482 032	CITROEN	C 15
0 986 482 036	VW (VOLKS- WAGEN)	California T4, Caravelle T4, Eurovan, Kombi, Multivan T4, Transporter T4
0 986 482 037	FIAT	Barchetta, Punto, Punto Cabrio, Punto Van
0 986 482 038	FIAT	Barchetta, Punto, Punto Cabrio, Punto Van
0 986 482 039	AUDI	80, 80 Avant
F 01G 09L ...		
F 01G 09L 02C	SUZUKI	X-90
F 01G 09L 04J	SUZUKI	Wagon R+
F 01G 060 ...		
F 01G 060 0KD	MITSUBISHI	L 200
F 01G 060 0KE	MITSUBISHI	L 200
F 01G 060 0LT	MITSUBISHI	L 200

de

Hydroaggregat

en

Hydraulic modulator

fr

Groupe hydraulique

it

Gruppo idraulico

es

Grupo hidráulico

nl

Hydroaggregaat

sv

Hydraulaggregat

pt

Módulo hidráulico

cs

Hydraulická jednotka

ru

Гидроагрегат

**0 265 200 ...**

0 265 200 027	MERCEDES-BENZ	Serie C, Serie CL (Coupé), Serie E, Serie E (Cabrio), Serie E (Coupé), Serie E (T-Modell), Serie G, Serie S, Serie S (Coupé), Serie SL, Serie 190
0 265 200 036	RENAULT	Alpine
0 265 200 040	BMW	Serie 3 Touring
0 265 200 041	OPEL VAUXHALL	Omega Carlton III
0 265 200 056	JAGUAR	XJ 12
0 265 200 064	PORSCHE	968
0 265 200 065	PORSCHE	928
0 265 200 071	SSANGYONG	Musso

0 265 201 ...

0 265 201 016	ALFA ROMEO LANCIA	164 Dedra Berlina
0 265 201 024	LANCIA	Dedra Berlina
0 265 201 031	MERCEDES-BENZ	Serie G
0 265 201 033	LANCIA	Delta
0 265 201 048	OPEL VAUXHALL	Calibra, Vectra Calibra, Cavalier III
0 265 201 050	AUDI	Cabriolet, Coupé, 80, 80 Avant, 90, 100, 100 Avant
0 265 201 054	ALFA ROMEO FIAT LANCIA	155 Marengo, Tempra, Tempra SW, Tipo Dedra Berlina
0 265 201 056	PEUGEOT	405, 405 Break
0 265 201 058	PEUGEOT	605
0 265 201 060	RENAULT	Safrane
0 265 201 064	NISSAN	Primera Hatchback, Primera Sedan
0 265 201 065	NISSAN	Primera Wagon

0 265 202 ...

0 265 202 022	MERCEDES-BENZ	Serie CL (Coupé), Serie E, Serie E (T-Modell), Serie S, Serie S (Coupé), Serie SL
0 265 202 023	MERCEDES-BENZ	Serie CL (Coupé), Serie E (T-Modell), Serie S (Coupé), Serie SL
0 265 202 025	BMW	Serie 7
0 265 202 110	MERCEDES-BENZ	Serie CL (Coupé), Serie E, Serie E (T-Modell), Serie S, Serie S (Coupé), Serie SL
0 265 202 403	AUDI VW (VOLKSWAGEN)	A4, A4 Avant, A6, A6 Allroad, A6 Avant, A8, RS4 Avant, S4, S4 Avant, S6, S6 Avant, S8 Passat, Passat Variant
0 265 202 411	BMW	Serie 5, Serie 5 Touring, Serie 7



0 265 202 414	MERCEDES-BENZ	Classe A, Serie A
0 265 202 419	PEUGEOT	406, 406 Break, 406 Coupé, 607
0 265 202 425	PORSCHE	911, 911 Cabriolet, 911 Carrera Cabriolet
0 265 202 435	MERCEDES-BENZ	Serie C, Serie C (T-Modell), Serie CLK (Cabrio), Serie CLK (Coupé), Serie E, Serie E (T-Modell), Serie SL
0 265 202 438	MERCEDES-BENZ	Serie C (T-Modell), Serie CLK (Cabrio), Serie CLK (Coupé), Serie E, Serie E (T-Modell), Serie S
0 265 202 441	MERCEDES-BENZ	Serie S
0 265 202 446	MERCEDES-BENZ	Serie CL (Coupé), Serie S
0 265 202 451	MERCEDES-BENZ	Serie C, Serie C (Sportcoupe), Serie C (T-Modell), Serie CLK (Cabrio), Serie CLK (Coupé), Serie SLK
0 265 202 454	VW (VOLKSWAGEN)	California T4, Caravelle T4, Eurovan, Multivan T4, Transporter T4
0 265 202 458	OPEL VAUXHALL	Astra, Astra Caravan, Zafira Astra, Astra Estate, Zafira
0 265 202 463	MERCEDES-BENZ	Classe A, Serie A, Vaneo
0 265 202 466	MERCEDES-BENZ	Serie C, Serie C (T-Modell), Serie CLK (Coupé), Serie E, Serie E (T-Modell), Serie SL
0 265 202 492	HOLDEN OPEL VAUXHALL	Astra Astra, Astra Cabrio, Astra Caravan, Astra Coupé, Zafira Astra, Astra Convertible, Astra Coupé, Astra Estate, Astra Van, Zafira
0 265 202 495	MERCEDES-BENZ	Serie C (T-Modell), Serie CLK (Cabrio), Serie CLK (Coupé), Serie E, Serie E (T-Modell), Serie G
0 265 202 503	OPEL VAUXHALL	Meriva Meriva
0 265 202 505	NISSAN	Primera, Primera Hatchback, Primera Wagon
0 265 202 507	NISSAN	Primera, Primera Hatchback, Primera Wagon
0 265 202 509	HOLDEN OPEL VAUXHALL	Astra Astra, Astra Cabrio, Astra Caravan, Astra Coupé, Zafira Astra, Astra Convertible, Astra Coupé, Astra Estate, Astra Van, Zafira
0 265 202 513	OPEL VAUXHALL	Omega Omega

de

Hydroaggregat
(Fortsetzung)

en

Hydraulic modulator
(continued)

fr

Groupe hydraulique
(suite)

it

Gruppo idraulico
(seguito)

es

Grupo hidráulico
(continuación)

0 265 202 517	NISSAN	Primera, Primera Hatchback, Primera Wagon
0 265 202 519	NISSAN	Primera, Primera Hatchback, Primera Wagon
0 265 202 521	SAAB (SAAB AUTO-MOBILE AB)	9-5, 9-5 Kombi
0 265 202 525	NISSAN	Primera, Primera Hatchback, Primera Wagon
0 265 204 ...		
0 265 204 004	ALFA ROMEO	GTV, Spider
	FIAT	Barchetta
	LANCIA	Thema Berlina, Thema Station Wagon
0 265 204 006	ALFA ROMEO	164
0 265 204 010	FIAT	Punto GT
0 265 204 014	FIAT	Punto, Punto Cabrio
0 265 205 ...		
0 265 205 007	AUDI	Coupé, Coupé S2, S4, 80, 80 Avant, 100, 100 Avant
0 265 205 011	VOLVO	740, 940, 960
0 265 205 016	FERRARI	512
0 265 206 ...		
0 265 206 016	NISSAN	Altima
0 265 208 ...		
0 265 208 002	ROVER	Serie 200, Serie 400, Serie 400 Tourer
0 265 208 032	ROVER	Serie 200, Serie 400, Serie 400 Tourer
0 265 208 034	ALFA ROMEO	145, 146, 155
	FIAT	Coupé, Croma, Marengo, Tempra, Tempra SW
	LANCIA	Dedra Berlina, Dedra Station Wagon, Delta
0 265 208 040	ROVER	Serie 600, Serie 800
0 265 208 305	PEUGEOT	405, 405 Break
0 265 208 311	CHEVROLET	Calibra
	OPEL	Astra, Astra Cabrio, Astra Caravan, Astra Classic, Astra Classic Caravan, Calibra, Vectra
	SAAB (SAAB AUTO-MOBILE AB)	900 II, 900 II Cabriolet, 900 II Coupé
	VAUXHALL	Astra, Astra Convertible, Astra Estate, Astra Van, Calibra, Cavalier III
0 265 208 321	CITROEN	ZX
	PEUGEOT	306, 306 Cabriolet



0 265 210 ...		
0 265 210 002	ALFA ROMEO	33 Berlina, 33 Sportwagon
0 265 211 ...		
0 265 211 006	AUDI	Cabriolet, Coupé, 80, 80 Avant, 90, 100, 100 Avant
0 265 211 008	PEUGEOT	605
0 265 212 ...		
0 265 212 004	CHEVROLET	Corvette Cabrio, Corvette Coupé
0 265 213 ...		
0 265 213 006	PORSCHE	911, 911 Targa
0 265 213 009	MERCEDES-BENZ	Serie C, Serie G
	STEYR (STEYR-DAIMLER-PUCH AG)	G
0 265 213 011	BMW	Serie 5, Serie 5 Touring, Serie 7
0 265 213 403	MERCEDES-BENZ	Serie C, Serie G
0 265 214 ...		
0 265 214 001	TOYOTA	Carina E Liftback, Carina E Sedan, Carina E Wagon
0 265 214 206	NISSAN	Micra
0 265 214 405	MERCEDES-BENZ	Serie A
0 265 215 ...		
0 265 215 005	MG	MG TF, MGF
0 265 215 008	DAEWOO	Korando
	SSANGYONG	Korando, Musso
0 265 215 010	DAEWOO	New Prince
0 265 215 402	PORSCHE	Boxster, 911, 911 Cabriolet
0 265 215 437	NISSAN	Terrano II
0 265 215 458	NISSAN	Terrano II
0 265 215 505	PORSCHE	Boxster
0 265 215 515	RENAULT	Clio II
0 265 215 523	PORSCHE	911
0 265 215 525	GAZ	GAZelle, Sobol
0 265 215 550	SMART (MCC)	Smart Cabrio, Smart Coupé, Smart Crossblade
0 265 215 552	SMART (MCC)	Smart Coupé
0 265 216 ...		
0 265 216 006	AUDI	A6
0 265 216 032	LANCIA	Kappa Berlina, Kappa Station Wagon
0 265 216 043	MG	ZR, ZS

nl

Hydroaggregaat
(vervolg)

sv

Hydraulaggregat
(fortsättning)

pt

Módulo hidráulico
(continuação)

cs

Hydraulická jednotka
(pokračování)

ru

Гидроагрегат
(продолжение)

		
0 265 216 043	ROVER	Serie 200, Serie 400, Serie 400 Coupé, Serie 400 Tourer, Serie 800, 25, 45
0 265 216 045	VOLVO	S40 I, V40 I
0 265 216 046	MITSUBISHI	Carisma, Carisma Hatchback
0 265 216 047	MG	ZS
	ROVER	Serie 400, Serie 400 Coupé, Serie 400 Tourer, 45
0 265 216 049	HONDA	Accord Sedan
	ROVER	Serie 600
0 265 216 303	PEUGEOT	406, 406 Break, 406 Coupé
0 265 216 312	RENAULT	Espace III
0 265 216 340	CITROEN	ZX
	PEUGEOT	306, 306 Cabriolet
0 265 216 341	PEUGEOT	605
0 265 216 402	ALFA ROMEO	156 Berlina, 156 Sport Wagon
0 265 216 404	LANCIA	Y
0 265 216 408	LANCIA	Y
0 265 216 410	OPEL	Combo, Corsa, Tigra
	VAUXHALL	Combo, Corsa, Tigra
0 265 216 413	AUDI	A4, A4 Avant
	VW (VOLKSWAGEN)	Passat, Passat Variant
0 265 216 416	VW (VOLKSWAGEN)	Gol III
0 265 216 418	FIAT	Palio, Punto, Punto Cabrio, Punto Van
0 265 216 422	SAAB (SAAB AUTO-MOBILE AB)	900 II, 900 II Cabriolet, 900 II Coupé
0 265 216 425	ALFA ROMEO	145, 146, 155, 164
	FIAT	Coupé, Punto GT
	LANCIA	Dedra Berlina, Dedra Station Wagon, Delta
0 265 216 436	CITROEN	Jumper
	FIAT	Ducato 10, Ducato 14
	PEUGEOT	Boxer
0 265 216 439	TOYOTA	Avalon
0 265 216 453	LANCIA	Kappa Berlina, Kappa Coupé, Kappa Station Wagon
0 265 216 463	VOLVO	S40 I, V40 I
0 265 216 465	MITSUBISHI	Carisma, Carisma Hatchback
0 265 216 470	SAAB (SAAB AUTO-MOBILE AB)	900 II, 900 II Cabriolet, 900 II Coupé
0 265 216 472	SAAB (SAAB AUTO-MOBILE AB)	9-3, 9-3 Cabriolet, 9-3 Coupé, 9-5, 9-5 Kombi, 900 II, 900 II Cabriolet, 900 II Coupé
0 265 216 473	OPEL	Omega
	VAUXHALL	Omega
0 265 216 474	OPEL	Astra, Astra Cabrio, Astra Caravan
	VAUXHALL	Astra, Astra Estate, Astra Van

		
0 265 216 475	OPEL	Omega
	VAUXHALL	Omega
0 265 216 479	OPEL	Corsa, Meriva
	VAUXHALL	Corsa, Meriva
0 265 216 481	RENAULT	Kangoo I
0 265 216 482	PEUGEOT	406, 406 Break, 406 Coupé, 605
0 265 216 483	CITROEN	Xsara, Xsara Coupé
	PEUGEOT	306, 306 Cabriolet
0 265 216 484	CITROEN	Xsara, Xsara Break, Xsara Coupé
	PEUGEOT	Partner, 306, 306 Break, 306 Cabriolet
0 265 216 486	TOYOTA	Avensis, Avensis Liftback, Avensis Wagon
0 265 216 494	MG	ZS
	ROVER	Serie 400, Serie 400 Coupé, Serie 400 Tourer, 45
0 265 216 496	CITROEN	Evasion, Jumpy
	FIAT	Scudo, Ulysse
	LANCIA	Zeta
	PEUGEOT	Expert, 806
0 265 216 498	MITSUBISHI	Lancer
0 265 216 500	ALFA ROMEO	166
0 265 216 504	FIAT	Barchetta
0 265 216 520	HONDA	Civic Aerodeck
	MG	ZR, ZS
	ROVER	Serie 200, Serie 400, Serie 400 Coupé, Serie 400 Tourer, 25, 45
0 265 216 526	FIAT	Multipla
0 265 216 530	CITROEN	Jumper
	FIAT	Ducato 18
	PEUGEOT	Boxer
0 265 216 532	ALFA ROMEO	GTV, Spider
0 265 216 534	LANCIA	Lybra Berlina, Lybra Station Wagon
0 265 216 544	PEUGEOT	406, 406 Break, 406 Coupé
0 265 216 550	FIAT	Palio, Palio Weekend, Siena
0 265 216 552	FIAT	Palio Weekend
0 265 216 554	CITROEN	Xsara Break
	PEUGEOT	306 Break
0 265 216 556	RENAULT	Megane I, Megane I Cabrio, Megane I Classic, Megane I Coupé, Scenic I
0 265 216 564	AUDI	A4, A4 Avant
	VW (VOLKSWAGEN)	Passat, Passat Variant
0 265 216 570	FIAT	Seicento
0 265 216 572	FIAT	Palio, Palio Weekend, Siena, Strada
0 265 216 587	NISSAN	Primera Hatchback, Primera Sedan, Primera Wagon
0 265 216 599	SUZUKI	Swift, Swift Hatchback
0 265 216 605	PEUGEOT	607
0 265 216 615	LANCIA	Y
0 265 216 619	FIAT	Punto, Punto Van
0 265 216 621	ALFA ROMEO	166

de

Hydroaggregat
(Fortsetzung)

en

Hydraulic modulator
(continued)

fr

Groupe hydraulique
(suite)

it

Gruppo idraulico
(seguito)

es

Grupo hidráulico
(continuación)

			
0 265 216 623	FIAT	Punto, Punto Van	
0 265 216 625	FORD	Transit, Transit Euroline, Transit Nugget, Transit Tourneo	
0 265 216 627	RENAULT	Clio II	
0 265 216 631	TOYOTA	Camry, Camry Sedan	
0 265 216 635	RENAULT	Safrane	
0 265 216 641	PEUGEOT	406, 406 Break, 406 Coupé	
0 265 216 643	CITROEN	Picasso, Xsara Picasso	
0 265 216 650	HONDA	Accord, Accord Hatchback, Accord Sedan, Civic Aerodeck, Civic Fastback	
0 265 216 652	OPEL	Astra, Astra Cabrio, Astra Caravan, Astra Coupé, Zafira	
	VAUXHALL	Astra, Astra Convertible, Astra Estate, Astra Van, Zafira	
0 265 216 658	NISSAN	Cefiro	
0 265 216 673	FORD	Transit, Transit Euroline, Transit Nugget, Transit Tourneo	
0 265 216 677	LANCIA	Kappa Berlina, Kappa Coupé, Kappa Station Wagon	
0 265 216 679	RENAULT	Megane, Megane I, Megane I Cabrio, Megane I Classic, Megane I Coupé, Megane I Grandtour	
0 265 216 681	RENAULT	Megane, Megane I, Megane I Cabrio, Megane I Classic, Megane I Coupé, Megane I Grandtour, Scenic, Scenic I	
0 265 216 685	HONDA	Civic Aerodeck	
	MG	ZR, ZS	
	ROVER	Serie 200, Serie 400, Serie 400 Coupé, Serie 400 Tourer, 25, 45	
0 265 216 687	ALFA ROMEO	145, 146	
0 265 216 689	NISSAN	Primera Hatchback, Primera Sedan, Primera Wagon	
0 265 216 691	RENAULT	Kangoo I	
0 265 216 699	PEUGEOT	306, 306 Break, 306 Cabriolet	
0 265 216 701	FORD	Cougar, Mondeo I, Mondeo II, Mondeo II Turnier	
0 265 216 703	RENAULT	Clio II, Thalia	
0 265 216 707	FIAT	Ducato 11, Ducato 15, Ducato 18	
0 265 216 709	FIAT	Ducato 10, Ducato 11, Ducato 14, Ducato 15, Ducato 18	
0 265 216 711	FIAT	Seicento	
0 265 216 713	FIAT	Barchetta	
0 265 216 721	CITROEN	Berlingo	
	PEUGEOT	Partner, Ranch	
0 265 216 723	CITROEN	Xsara, Xsara Break, Xsara Coupé	
	PEUGEOT	306, 306 Break, 306 Cabriolet	
0 265 216 725	CITROEN	Evasion, Jumpy	
	PEUGEOT	Expert, 806	
0 265 216 727	RENAULT	Avantime, Espace III	
0 265 216 741	RENAULT	Kangoo I	
0 265 216 743	LANCIA	Kappa Berlina, Kappa Coupé, Kappa Station Wagon	
0 265 216 758	PEUGEOT	307, 307 Break/SW, 307 CC	

			
0 265 216 774	NISSAN	Carisma, Carisma Hatchback	
0 265 216 776	NISSAN	Spacestar	
0 265 216 782	ALFA ROMEO	GTV, Spider	
0 265 216 788	NISSAN	Almera Tino	
0 265 216 790	NISSAN	Almera Tino	
0 265 216 802	ALFA ROMEO	156 Berlina, 156 Sport Wagon, 156 Sportwagon	
0 265 216 810	LANCIA	Lybra Berlina, Lybra Station Wagon	
0 265 216 826	TOYOTA	Avensis, Avensis Liftback, Avensis Wagon	
0 265 216 828	FIAT	Albea, Palio, Palio Weekend, Siena, Strada	
0 265 216 845	IVECO	Daily	
0 265 216 851	TOYOTA	Corolla, Corolla Hatchback, Corolla RunX, Corolla Sedan, Corolla Wagon	
0 265 216 853	TOYOTA	Yaris	
0 265 216 863	PEUGEOT	607	
0 265 216 873	RENAULT	Clio II, Thalia	
0 265 216 875	CHEVROLET	Lacetti, Nubira, Nubira Wagon, Optra Hatchback	
	DAEWOO	Lacetti, Nubira, Nubira Station Wagon	
0 265 216 877	HYUNDAI	Sonata	
	KIA	Magentis, Optima	
0 265 216 881	RENAULT	Kangoo I	
0 265 216 898	NISSAN	Primera Hatchback, Primera Sedan, Primera Wagon	
0 265 216 900	NISSAN	Almera Hatchback, Almera Sedan	
0 265 216 901	NISSAN	Almera Hatchback, Almera Sedan	
0 265 216 902	NISSAN	Almera Tino	
0 265 216 903	NISSAN	Almera Tino	
0 265 216 905	TOYOTA	Yaris	
0 265 216 915	HYUNDAI	Sonata	
0 265 216 929	KIA	Sorento	
0 265 216 944	FIAT	Punto	
0 265 216 946	FIAT	Punto, Punto Van	
0 265 216 954	RENAULT	Megane I Cabrio, Megane I Coupé	
0 265 216 956	RENAULT	Megane, Megane I Coupé, Scenic	
0 265 216 960	FIAT	Multipla	
0 265 216 990	CHEVROLET	Matiz, Spark	
	DAEWOO	Matiz	
0 265 216 999	FORD	Transit	
0 265 217 ...			
0 265 217 002	BMW	Serie 5, Serie 5 Touring, Serie 7, Serie 8	
0 265 217 004	MERCEDES-BENZ	Classe A, Serie A, Serie C, Serie CL (Coupé), Serie S, Serie S (Coupé), Serie SL	
0 265 217 006	PORSCHE	911, 911 Targa	
0 265 217 008	MERCEDES-BENZ	Serie C, Serie CL (Coupé), Serie E, Serie E (T-Modell), Serie S, Serie S (Coupé), Serie SL	

nl

Hydroaggregaat
(vervolg)

sv

Hydraulaggregat
(fortsättning)

pt



Módulo hidráulico
(continuação)

cs

Hydraulická jednotka
(pokračování)

ru

Гидроагрегат
(продолжение)

		
0 265 217 013	DAEWOO	Korando, Musso
	SSANGYONG	Korando, Musso
0 265 217 403	MERCEDES-BENZ	Serie C, Serie E, Serie E (T-Modell), Serie SL
0 265 217 415	SSANGYONG	Korando, Musso
0 265 218 ...		
0 265 218 008	AUDI	A6, A6 Avant
0 265 218 022	AUDI	A4, A4 Avant, A6, A6 Avant, S6, S6 Avant
0 265 218 024	FERRARI	456
0 265 218 611	CHEVROLET	Niva
0 265 218 662	TOYOTA	Yaris
0 265 219 ...		
0 265 219 402	PORSCHE	Boxster, 911, 911 Cabriolet
0 265 219 427	IVECO	Daily
0 265 220 ...		
0 265 220 025	OPEL	Vectra, Vectra Caravan
	VAUXHALL	Vectra, Vectra Estate
0 265 220 407	AUDI	A4, A4 Avant, A6, A6 Avant
	SKODA	Superb
	VW (VOLKSWAGEN)	Passat, Passat Variant
0 265 220 410	AUDI	A4, A4 Avant, A6, A6 Avant, A8, S4, S4 Avant, S6, S6 Avant, S8
	VW (VOLKSWAGEN)	Passat, Passat Variant
0 265 220 413	AUDI	A4, A4 Avant, A6, A6 Avant, A8
	VW (VOLKSWAGEN)	Passat, Passat Variant
0 265 220 415	ALFA ROMEO	166
0 265 220 434	VW (VOLKSWAGEN)	California T4, Caravelle T4, Kombi, Multivan T4, Transporter T4
0 265 220 440	AUDI	A4, A4 Avant, A6
	VW (VOLKSWAGEN)	Passat, Passat Variant
0 265 220 443	AUDI	A4, A4 Avant, A8
0 265 220 446	AUDI	A4, A4 Avant
	VW (VOLKSWAGEN)	Passat, Passat Variant
0 265 220 449	CADILLAC	Catera
	OPEL	Omega
	VAUXHALL	Omega
0 265 220 450	OPEL	Astra, Astra Caravan
	VAUXHALL	Astra, Astra Estate
0 265 220 454	ALFA ROMEO	166
0 265 220 458	OPEL	Vectra, Vectra Caravan
	VAUXHALL	Vectra, Vectra Estate
0 265 220 460	DAEWOO	Leganza
0 265 220 468	FORD	Transit, Transit Euroline, Transit Nugget, Transit Tourneo

		
0 265 220 487	FORD	Transit
0 265 220 489	MERCEDES-BENZ	Sprinter
	VW (VOLKSWAGEN)	LT
0 265 220 491	MERCEDES-BENZ	Serie V, Vito
0 265 220 495	FORD	Cougar, Mondeo I, Mondeo II, Mondeo II Turnier
0 265 220 521	SAAB (SAAB AUTO-MOBILE AB)	9-5, 9-5 Kombi
0 265 220 527	AUDI	A4, A4 Avant, A6, A6 Avant, A8
	VW (VOLKSWAGEN)	Passat, Passat Variant
0 265 220 532	OPEL	Astra, Astra Caravan, Astra Coupé, Zafira
	VAUXHALL	Astra, Astra Coupé, Astra Estate, Zafira
0 265 220 539	FORD	Transit, Transit Euroline, Transit Nugget, Transit Tourneo
0 265 220 545	RENAULT	Scenic I
0 265 220 547	LANCIA	Lybra Berlina, Lybra Station Wagon
0 265 220 553	FIAT	Punto
0 265 220 557	SAAB (SAAB AUTO-MOBILE AB)	9-5, 9-5 Kombi
0 265 220 583	OPEL	Vectra, Vectra Caravan
	VAUXHALL	Vectra, Vectra Estate
0 265 220 585	HOLDEN	Astra
	OPEL	Astra, Astra Cabrio, Astra Caravan, Astra Coupé, Zafira
	VAUXHALL	Astra, Astra Convertible, Astra Coupé, Astra Estate, Astra Van, Zafira
0 265 220 601	RENAULT	Kangoo I
0 265 220 603	ALFA ROMEO	166
0 265 220 626	SAAB (SAAB AUTO-MOBILE AB)	9-3, 9-3 Cabriolet, 9-3 Coupé, 9-5, 9-5 Kombi
0 265 220 637	HOLDEN	Astra
	OPEL	Astra, Astra Cabrio, Astra Caravan, Astra Coupé, Zafira
	VAUXHALL	Astra, Astra Convertible, Astra Coupé, Astra Estate, Astra Van, Zafira
0 265 220 639	VW (VOLKSWAGEN)	Passat, Passat Variant
0 265 220 645	OPEL	Omega
	VAUXHALL	Omega
0 265 220 651	CHEVROLET	Lacetti, Nubira, Nubira Wagon, Optra Hatchback
	DAEWOO	Lacetti, Nubira, Nubira Station Wagon

Hydroaggregat
(Fortsetzung)**Hydraulic modulator**
(continued)**Groupe hydraulique**
(suite)**Gruppo idraulico**
(seguito)**Grupo hidráulico**
(continuación)

0 265 220 653	HYUNDAI	Sonata
0 265 220 655	HYUNDAI	Sonata
	KIA	Magentis
0 265 220 659	OPEL	Corsa, Meriva
	VAUXHALL	Corsa, Meriva
0 265 220 667	RENAULT	Kangoo I
0 265 220 669	RENAULT	Scenic I
0 265 220 692	ALFA ROMEO	GTV, Spider
0 265 220 693	FORD	Transit
0 265 222 010	CITROEN	C8
	FIAT	Ulysse
	LANCIA	Phedra
	PEUGEOT	807

0 265 222 ...

0 265 222 022	JAGUAR	X-Type, X-Type Estate
0 265 222 026	PORSCHE	Boxster, 911, 911 Cabriolet, 911 Targa
0 265 222 031	FORD	Mondeo, Mondeo III, Mondeo III Turnier
0 265 222 033	PORSCHE	911
0 265 222 035	FIAT	Stilo, Stilo Multi Wagon
0 265 222 038	VW (VOLKSWAGEN)	Fox
0 265 222 041	ALFA ROMEO	147
0 265 222 043	ALFA ROMEO	GT

0 265 223 ...

0 265 223 002	BMW	Serie 5, Serie 5 Touring, Serie 7
0 265 223 006	MG	ZT, ZT-Tourer
	ROVER	75, 75 Tourer

0 265 224 ...

0 265 224 005	MG	ZT, ZT-Tourer
	ROVER	75, 75 Tourer
0 265 224 010	MG	ZT, ZT-Tourer
	ROVER	75, 75 Tourer
0 265 224 013	SEAT	Cordoba, Ibiza
	SKODA	Fabia, Fabia Combi, Fabia Schrägheck
0 265 224 047	JAGUAR	X-Type, X-Type Estate
0 265 224 049	FIAT	Stilo, Stilo Multi Wagon
0 265 224 064	MERCEDES-BENZ	Serie V
0 265 224 066	MERCEDES-BENZ	Serie V, Vito
0 265 224 082	MERCEDES-BENZ	Sprinter
0 265 224 086	MERCEDES-BENZ	Sprinter
0 265 224 088	MERCEDES-BENZ	Sprinter



0 265 224 090	MERCEDES-BENZ	Sprinter
0 265 224 092	MERCEDES-BENZ	Sprinter
0 265 224 094	FIAT	Stilo
0 265 224 102	ALFA ROMEO	147

0 265 225 ...

0 265 225 004	ALFA ROMEO	166
0 265 225 006	BMW	Serie Z, Serie 5, Serie 5 Touring, Serie 7
0 265 225 010	BMW	Serie X
0 265 225 019	PORSCHE	911, 911 Cabriolet
0 265 225 044	FIAT	Multipla
0 265 225 047	AUDI	A4, A4 Avant, A4 Cabriolet
0 265 225 050	AUDI	A4, A4 Avant, A4 Cabriolet
0 265 225 056	VW (VOLKSWAGEN)	Phaeton
0 265 225 060	LAND ROVER GROUP	Range Rover III
0 265 225 068	JAGUAR	X-Type, X-Type Estate
0 265 225 076	PORSCHE	Boxster
0 265 225 088	AUDI	S6, S6 Avant
	VW (VOLKSWAGEN)	Passat, Passat Variant
0 265 225 092	FIAT	Stilo, Stilo Multi Wagon
0 265 225 094	ALFA ROMEO	166
0 265 225 098	PORSCHE	911
0 265 225 100	PORSCHE	911, 911 Cabriolet
0 265 225 102	PORSCHE	911, 911 Cabriolet, 911 Targa
0 265 225 106	RENAULT	Megane I, Megane I Cabrio, Megane I Classic, Megane I Coupé, Megane I Grandtour
0 265 225 108	RENAULT	Scenic I
0 265 225 110	RENAULT	Clio II
0 265 225 122	AUDI	A6, A6 Avant
	VW (VOLKSWAGEN)	Passat, Passat Variant
0 265 225 125	AUDI	A6, A6 Avant
	VW (VOLKSWAGEN)	Passat, Passat Variant
0 265 225 128	CITROEN	Xsara, Xsara Break, Xsara Coupé
0 265 225 130	CITROEN	Berlingo
	PEUGEOT	Partner
0 265 225 134	AUDI	A8
0 265 225 137	AUDI	A8
0 265 225 141	SKODA	Superb
0 265 225 143	ALFA ROMEO	147
0 265 225 147	BMW	Serie X
0 265 225 153	BMW	Serie 3, Serie 3 Touring
0 265 225 159	CITROEN	Xsara Picasso

nl

Hydroaggregaat
(vervolg)

sv

Hydraulaggregat
(fortsättning)

pt

Módulo hidráulico
(continuação)



cs

Hydraulická jednotka
(pokračování)

ru

Гидроагрегат
(продолжение)

		
0 265 225 162	SEAT	Cordoba, Ibiza
	VW (VOLKS- WAGEN)	Polo, Polo Limousine
0 265 225 166	CITROEN	C8
	FIAT	Ulysse
	LANCIA	Phedra
	PEUGEOT	807
0 265 225 169	AUDI	RS6, RS6 Avant
0 265 225 170	FORD	Mondeo III, Mondeo III Turnier
0 265 225 184	RENAULT	Avantime
0 265 225 189	PEUGEOT	307, 307 Break/SW
0 265 225 196	ALFA ROMEO	166
0 265 225 216	PEUGEOT	307 CC
0 265 225 225	MERCEDES- BENZ	Sprinter
0 265 225 233	FIAT	Stilo, Stilo Multi Wagon
0 265 225 241	AUDI	A4 Cabriolet, S4, S4 Avant, S4 Cabriolet
0 265 225 243	MAZDA	RX-8
0 265 225 255	ALPINA	Roadster
0 265 225 260	RENAULT	Clio II, Clio II Sedan, Thalia
0 265 225 262	TOYOTA	Corolla Hatchback
0 265 225 264	ALFA ROMEO	156 Sport Wagon, 156 Sport Wagon Q4
0 265 225 267	FORD	Mondeo III, Mondeo III Turnier
0 265 225 281	ALFA ROMEO	156 Berlina, 156 Sport Wagon, 156 Sportwagon
0 265 225 282	TOYOTA	Avensis, Avensis Liftback, Avensis Wagon
0 265 225 285	TOYOTA	Corolla Verso
0 265 225 287	TOYOTA	Corolla, Corolla Hatchback, Corolla Wagon
0 265 225 289	TOYOTA	Corolla, Corolla Hatchback, Corolla Wagon
0 265 225 291	TOYOTA	Corolla, Corolla Hatchback, Corolla Wagon
0 265 225 293	TOYOTA	Corolla Hatchback
0 265 225 296	AUDI	A8
0 265 225 300	MERCEDES- BENZ	Sprinter
0 265 225 302	MERCEDES- BENZ	Sprinter
0 265 225 304	MERCEDES- BENZ	Sprinter
0 265 225 318	AUDI	A8
0 265 225 326	TOYOTA	Avensis, Avensis Liftback, Avensis Wagon
0 265 225 329	AUDI	A8
0 265 225 331	MERCEDES- BENZ	Sprinter
0 265 225 340	FORD	Mondeo III, Mondeo III Turnier
0 265 225 347	MERCEDES- BENZ	Viano, Vito
0 265 225 350	AUDI	A8

		
0 265 225 353	AUDI	A8
0 265 225 374	AUDI	A8, S8
0 265 225 376	SMART (MCC)	Fortwo Coupé, Roadster, Roadster Coupé
0 265 225 388	TOYOTA	Avensis, Avensis Liftback, Avensis Wagon
0 265 225 390	TOYOTA	Avensis, Avensis Liftback, Avensis Wagon
0 265 225 395	FORD	Mondeo III Turnier
0 265 225 398	ALFA ROMEO	147
0 265 225 399	ALFA ROMEO	GT
0 265 225 409	AUDI	A8
0 265 225 414	ALPINA	B7
	BMW	Serie 7
	ROLLS- ROYCE	Phantom, Phantom Coupé, Phantom Drophead
0 265 230 ...		
0 265 230 002	FIAT	Ducato 11, Ducato 15, Ducato 17, Ducato 20
0 265 230 010	FIAT	Idea
	LANCIA	Musa
0 265 230 020	FIAT	Panda
0 265 230 192	ALFA ROMEO	MiTo
0 265 230 235	VW (VOLKS- WAGEN)	Crafter 30, Crafter 35
0 265 230 237	VW (VOLKS- WAGEN)	Crafter 50
0 265 230 249	FIAT	Panda
0 265 230 258	MERCEDES- BENZ	Serie G
0 265 230 284	FIAT	500, 500C
0 265 230 286	OPEL	Corsa
	VAUXHALL	Corsa
0 265 230 288	OPEL	Corsa
	VAUXHALL	Corsa
0 265 230 309	FIAT	Linea
0 265 230 323	NISSAN	Teana
0 265 230 324	NISSAN	Teana
0 265 230 391	SMART (MCC)	Fortwo ED Cabrio, Fortwo ED Coupé
0 265 230 402	MERCEDES- BENZ	Sprinter
	VW (VOLKS- WAGEN)	Crafter 30, Crafter 35
0 265 230 404	MERCEDES- BENZ	Sprinter
	VW (VOLKS- WAGEN)	Crafter 50
0 265 230 406	MERCEDES- BENZ	Viano, Vito

de

Hydroaggregat
(Fortsetzung)

en

Hydraulic modulator
(continued)

fr



Groupe hydraulique
(suite)

it

Gruppo idraulico
(seguito)

es

Grupo hidráulico
(continuación)

			
0 265 230 408	MERCEDES-BENZ	Viano, Vito	
0 265 230 417	INFINITI	EX	
0 265 230 419	INFINITI	EX	
0 265 230 478	CITROEN	C4 Grand Picasso, C4 Picasso	
0 265 230 502	PEUGEOT	308, 308 CC, 308 SW	
0 265 230 509	CITROEN	Berlingo	
	PEUGEOT	Partner	
0 265 230 697	NISSAN	Qashqai	
0 265 230 752	DACIA	Duster	
	RENAULT	Duster	
0 265 230 807	FIAT	Ducato 11, Ducato 15, Ducato 17, Ducato 20	
0 265 230 823	FIAT	500, 500C	
0 265 230 857	NISSAN	NV200	
0 265 231 ...			
0 265 231 301	RENAULT	Grand Scenic II, Megane II Cabrio, Megane II Grandtour, Megane II Hatchback, Scenic II	
0 265 231 307	OPEL	Combo, Corsa, Tigra TwinTop	
	VAUXHALL	Corsa, Tigra TwinTop	
0 265 231 318	NISSAN	Primera, Primera Hatchback, Primera Wagon	
0 265 231 328	TOYOTA	Avensis, Avensis Liftback, Avensis Wagon	
0 265 231 332	FIAT	Punto, Punto Van	
0 265 231 334	RENAULT	Clio II, Clio II Sedan, Thalia, Twingo I	
0 265 231 358	HYUNDAI	Getz	
0 265 231 360	RENAULT	Modus	
0 265 231 366	FIAT	Punto	
0 265 231 416	NISSAN	Almera Hatchback, Almera Sedan	
0 265 231 418	NISSAN	Almera Tino	
0 265 231 428	NISSAN	Almera Hatchback, Almera Sedan	
0 265 231 436	SEAT	Cordoba, Ibiza	
	SKODA	Fabia, Fabia Combi, Fabia Schrägheck	
	VW (VOLKSWAGEN)	Polo, Polo Limousine, Polo Sedan	
0 265 231 444	OPEL	Combo, Corsa, Tigra TwinTop	
	VAUXHALL	Corsa, Tigra TwinTop	
0 265 231 451	IVECO	Daily	
0 265 231 453	IVECO	Daily	
0 265 231 463	FORD	Mondeo III, Mondeo III Turnier	
0 265 231 465	TOYOTA	Avensis, Avensis Liftback, Avensis Wagon	
0 265 231 485	TOYOTA	Corolla Verso	
0 265 231 487	CITROEN	C4, C4 Coupé	
	PEUGEOT	307, 307 Break/SW, 307 CC	
0 265 231 523	CITROEN	Berlingo, Xsara Picasso	
	PEUGEOT	Partner	
0 265 231 530	MITSUBISHI	Colt	
0 265 231 536	FIAT	Punto Grande	
0 265 231 562	LDV GROUP LIMITED	Maxus	

			
0 265 231 565	PEUGEOT	307	
0 265 231 580	CITROEN	C1	
	PEUGEOT	107	
	TOYOTA	Aygo	
0 265 231 604	HONDA	FR-V	
0 265 231 618	FIAT	Ducato 11, Ducato 15, Ducato 17, Ducato 20	
0 265 231 633	ALFA ROMEO	GT, 147	
0 265 231 635	KIA	Carnival	
0 265 231 669	SUZUKI	SX4 Hatchback	
0 265 231 671	SUZUKI	SX4 Hatchback	
0 265 231 673	FIAT	Idea	
	LANCIA	Musa	
0 265 231 704	FORD	Transit, Transit Euroline, Transit Nugget, Transit Tourneo	
0 265 231 705	FORD	Transit	
0 265 231 717	SKODA	Fabia, Fabia Combi, Fabia Schrägheck	
0 265 231 733	NISSAN	Note	
0 265 231 735	RENAULT	Megane II, Megane II Cabrio, Megane II Grandtour, Megane II Hatchback	
0 265 231 741	LANCIA	Musa	
0 265 231 775	LADA	Kalina, Kalina Hatchback, Kalina Kombi, Priora, Priora Hatchback, Priora Kombi	
0 265 231 803	RENAULT	Modus	
0 265 231 807	FIAT	Stilo, Stilo Multi Wagon	
0 265 231 842	NISSAN	Micra, Micra CC	
0 265 231 844	OPEL	Corsa	
	VAUXHALL	Corsa	
0 265 231 880	SUBARU	Legacy, Legacy Kombi	
0 265 231 882	SUBARU	Legacy, Legacy Kombi	
0 265 231 884	SUBARU	Legacy Outback	
0 265 231 886	SUBARU	Legacy Outback	
0 265 231 892	IVECO	Daily	
0 265 231 894	IVECO	Daily	
0 265 231 896	IVECO	Daily	
0 265 231 900	NISSAN	Qashqai	
0 265 231 902	NISSAN	Qashqai	
0 265 231 912	FORD	Transit	
0 265 231 927	FIAT	Punto Grande	
0 265 231 929	FIAT	Bravo	
0 265 231 960	TOYOTA	Corolla	
0 265 231 962	DAIHATSU	Cuore	
0 265 231 996	FIAT	Linea	
0 265 232 ...			
0 265 232 000	FIAT	Linea	
0 265 232 012	TOYOTA	Avensis, Avensis Wagon	
0 265 232 022	FIAT	Panda	
0 265 232 058	SUBARU	Legacy, Legacy Kombi	
0 265 232 062	SUBARU	Legacy Outback	
0 265 232 064	SUBARU	Legacy Outback	

nl

Hydroaggregaat
(vervolg)

sv

Hydraulaggregat
(fortsättning)

pt

Módulo hidráulico
(continuação)



cs

Hydraulická jednotka
(pokračování)

ru

Гидроагрегат
(продолжение)

		
0 265 232 068	RENAULT	Grand Scenic II, Megane II, Megane II Cabrio, Megane II Grandtour, Megane II Hatchback, Scenic II
0 265 232 070	RENAULT	Clio II, Clio II Sedan
0 265 232 076	RENAULT	Modus
0 265 232 078	RENAULT	Clio III, Clio III Grandtour
0 265 232 080	SUBARU	Impreza
0 265 232 088	CITROEN	C4 Sedan
0 265 232 090	SUZUKI	SX4, SX4 Hatchback
0 265 232 111	DACIA	Logan MCV, Sandero
	RENAULT	Logan, Logan MCV
0 265 232 113	FIAT	Ducato 11, Ducato 15, Ducato 17, Ducato 20
0 265 232 115	FIAT	Ducato 11, Ducato 15, Ducato 18
0 265 232 130	FIAT	Idea
	LANCIA	Musa
0 265 232 213	OPEL	Combo, Corsa, Meriva, Tigra TwinTop
	VAUXHALL	Combo, Corsa, Meriva, Tigra TwinTop
0 265 232 215	OPEL	Combo, Corsa, Tigra TwinTop
	VAUXHALL	Combo, Corsa, Tigra TwinTop
0 265 232 221	NISSAN	Qashqai+2
0 265 232 225	FIAT	Panda
0 265 232 237	FORD	Ka
0 265 232 239	OPEL	Corsa
	VAUXHALL	Corsa
0 265 232 241	FIAT	Strada
0 265 232 246	SEAT	Cordoba, Ibiza
	VW (VOLKSWAGEN)	Polo, Polo Limousine, Polo Vivo
0 265 232 249	SEAT	Cordoba, Ibiza
	VW (VOLKSWAGEN)	Polo
0 265 232 252	SEAT	Cordoba, Ibiza
	VW (VOLKSWAGEN)	Polo
0 265 232 255	SEAT	Cordoba, Ibiza
	VW (VOLKSWAGEN)	Polo
0 265 232 278	SKODA	Fabia, Fabia Combi, Praktik, Roomster
0 265 232 281	SKODA	Fabia, Fabia Combi, Praktik, Roomster
0 265 232 284	SKODA	Fabia, Fabia Combi, Praktik, Roomster
0 265 232 287	SKODA	Fabia, Fabia Combi, Praktik, Roomster
0 265 232 289	OPEL	Corsa
	VAUXHALL	Corsa
0 265 232 291	FIAT	500, 500C
0 265 232 294	VW (VOLKSWAGEN)	Fox
0 265 232 372	RENAULT	Clio II, Kangoo I, Thalia
0 265 232 383	SUBARU	Impreza, Impreza Sedan

		
0 265 232 385	DACIA	Duster
	RENAULT	Duster
0 265 232 387	DACIA	Duster
	RENAULT	Duster
0 265 232 404	NISSAN	Evalia, NV200
0 265 232 412	IVECO	Daily
0 265 232 414	IVECO	Daily
0 265 232 416	IVECO	Daily
0 265 232 440	PEUGEOT	308, 308 SW
0 265 232 520	CITROEN	Berlingo
	PEUGEOT	Partner
0 265 232 534	SUZUKI	SX4, SX4 Hatchback
0 265 232 653	FIAT	Grande Punto, Punto, Punto Evo, Punto Grande
0 265 232 719	DACIA	Logan, Logan MCV, Logan Pick-Up, Sandero
	RENAULT	Logan, Logan MCV, Sandero
0 265 232 731	TOYOTA	Auris
0 265 232 755	RENAULT	Kangoo II
0 265 232 787	ALFA ROMEO	MiTo
0 265 232 831	FIAT	Fiorino, Qubo
0 265 233 ...		
0 265 233 026	IVECO	Daily
0 265 233 028	IVECO	Daily, Daily Furgao
0 265 233 030	RENAULT	Mascott
0 265 233 330	FIAT	Ducato 11, Ducato 15, Ducato 17, Ducato 20
0 265 233 336	ALFA ROMEO	147
0 265 233 341	FORD	Transit, Transit Euroline, Transit Nugget, Transit Tourneo
0 265 233 342	FORD	Transit
0 265 233 360	IVECO	Daily
0 265 233 362	FIAT	Ducato 11, Ducato 15, Ducato 17, Ducato 20
0 265 233 364	FIAT	Panda
0 265 233 376	IVECO	Daily
0 265 233 378	IVECO	Daily
0 265 233 380	IVECO	Daily
0 265 234 ...		
0 265 234 007	FIAT	Punto, Punto Van
0 265 234 013	FIAT	Panda
0 265 234 021	FIAT	Stilo, Stilo Multi Wagon
0 265 234 036	BMW	Serie X
0 265 234 038	PEUGEOT	807
0 265 234 044	MERCEDES-BENZ	Serie A, Serie B
0 265 234 051	VAUXHALL	Corsa, Meriva
0 265 234 053	PEUGEOT	607
0 265 234 061	CITROEN	Berlingo, Xsara Picasso
	PEUGEOT	Partner

de

Hydroaggregat
(Fortsetzung)

en

Hydraulic modulator
(continued)

fr

Groupe hydraulique
(suite)

it

Gruppo idraulico
(seguito)

es

Grupo hidráulico
(continuación)

0 265 234 069	FIAT	Ducato 11, Ducato 15, Ducato 17, Ducato 20	
0 265 234 089	PORSCHE	911, 911 Cabriolet, 911 Speedster	
0 265 234 096	BMW	Serie X	
0 265 234 098	VW (VOLKSWAGEN)	Crafter 30, Crafter 35	
0 265 234 100	VW (VOLKSWAGEN)	Crafter 50	
0 265 234 113	AUDI	A6	
0 265 234 116	AUDI	A6	
0 265 234 119	SEAT	Cordoba, Ibiza	
	SKODA	Fabia, Fabia Combi, Fabia Schrägheck	
	VW (VOLKSWAGEN)	Polo	
0 265 234 123	NISSAN	Micra	
0 265 234 129	RENAULT	Megane II Grandtour, Megane II Hatchback	
0 265 234 135	BMW	Serie 5, Serie 5 Touring, Serie 6, Serie 6 Cabrio	
0 265 234 137	BMW	Serie 5, Serie 5 Touring, Serie 6, Serie 6 Cabrio	
0 265 234 143	PORSCHE	Boxster, Cayman	
0 265 234 145	CITROEN	C4, C4 Coupé	
0 265 234 147	NISSAN	Primera, Primera Hatchback, Primera Wagon	
0 265 234 149	SAAB (SAAB AUTO-MOBILE AB)	9-5, 9-5 Kombi	
0 265 234 154	NISSAN	Micra	
0 265 234 156	LAND ROVER GROUP	Discovery III, Range Rover III, Range Rover Sport	
0 265 234 158	RENAULT	Clio III, Clio III Grandtour	
0 265 234 185	NISSAN	Primera, Primera Hatchback, Primera Wagon	
0 265 234 208	AUDI	A6, A6 Avant	
0 265 234 211	AUDI	A6, A6 Avant	
0 265 234 213	CITROEN	Jumpy	
	PEUGEOT	Expert	
0 265 234 223	TOYOTA	Corolla Verso	
0 265 234 229	AUDI	RS4, RS4 Avant, RS4 Cabriolet	
0 265 234 257	MITSUBISHI	Colt	
0 265 234 259	ALFA ROMEO	GT, 147	
0 265 234 262	AUDI	A6, A6 Avant	
0 265 234 265	AUDI	A6, A6 Avant	
0 265 234 267	HONDA	FR-V	
0 265 234 269	HONDA	FR-V	
0 265 234 276	NISSAN	Micra	
0 265 234 278	NISSAN	Micra	
0 265 234 282	NISSAN	Micra CC	
0 265 234 284	NISSAN	Micra, Micra CC	
0 265 234 307	SMART (MCC)	Fortwo Cabrio, Fortwo Coupé, Roadster	

0 265 234 311	RENAULT	Grand Scenic II, Megane II, Megane II Cabrio, Megane II Grandtour, Megane II Hatchback, Scenic II	
0 265 234 316	MITSUBISHI	Colt	
0 265 234 326	FIAT	Idea	
	LANCIA	Musa	
0 265 234 329	AUDI	A4, A4 Avant, S4, S4 Avant	
0 265 234 332	AUDI	A4, A4 Avant	
0 265 234 335	AUDI	A4, A4 Avant, A4 Cabriolet, S4, S4 Avant, S4 Cabriolet	
0 265 234 338	AUDI	A4, A4 Avant, A4 Cabriolet	
	SEAT	Exeo, Exeo ST	
0 265 234 340	OPEL	Combo, Corsa, Meriva, Tigra TwinTop	
	VAUXHALL	Combo, Corsa, Meriva, Tigra TwinTop	
0 265 234 353	FIAT	Stilo, Stilo Multi Wagon	
0 265 234 354	FORD	Transit, Transit Euroline, Transit Nugget, Transit Tourneo	
0 265 234 355	FORD	Transit	
0 265 234 363	SEAT	Cordoba, Ibiza	
	SKODA	Fabia, Fabia Combi, Fabia Schrägheck	
0 265 234 371	MAZDA	MX-5	
0 265 234 431	SAAB (SAAB AUTO-MOBILE AB)	9-5, 9-5 Kombi	
0 265 234 459	PEUGEOT	307, 307 Break/SW, 307 CC	
0 265 234 461	CITROEN	C4 Sedan	
0 265 234 469	RENAULT	Megane II, Megane II Cabrio, Megane II Grandtour, Megane II Hatchback	
0 265 234 500	MITSUBISHI	Colt	
	SMART (MCC)	Forfour	
0 265 234 511	RENAULT	Grand Scenic II, Scenic II	
0 265 234 522	IVECO	Daily	
0 265 234 524	IVECO	Daily	
0 265 234 528	IVECO	Daily	
0 265 234 545	FIAT	Punto Grande	
0 265 234 551	INFINITI	M	
0 265 234 553	INFINITI	M	
0 265 234 566	INFINITI	G	
0 265 234 572	INFINITI	M	
0 265 234 595	HONDA	FR-V	
0 265 234 600	INFINITI	M	
0 265 234 608	MAZDA	CX-7	
0 265 234 614	RENAULT	Megane II Grandtour, Megane II Hatchback	
0 265 234 615	RENAULT	Megane II Grandtour, Megane II Hatchback	
0 265 234 619	RENAULT	Modus	
0 265 234 651	DAIHATSU	Cuore	
0 265 234 653	DAIHATSU	Cuore	
0 265 234 661	SUBARU	Legacy, Legacy Kombi	
0 265 234 663	SUBARU	Legacy, Legacy Kombi, Legacy Outback	

nl

Hydroaggregaat
(vervolg)

sv

Hydraulaggregat
(fortsättning)

pt



Módulo hidráulico
(continuação)



cs

Hydraulická jednotka
(pokračování)

ru

Гидроагрегат
(продолжение)

		
0 265 234 680	RENAULT	Grand Scenic II, Scenic II
0 265 234 695	VAUXHALL	Meriva
0 265 234 697	VAUXHALL	Meriva
0 265 234 700	SEAT	Cordoba, Ibiza
	SKODA	Fabia, Fabia Combi, Fabia Schrägheck
	VW (VOLKSWAGEN)	Polo
0 265 234 703	SEAT	Cordoba, Ibiza
	VW (VOLKSWAGEN)	Polo, Polo Limousine
0 265 234 714	SKODA	Fabia, Fabia Combi, Praktik, Roomster
0 265 234 717	SKODA	Fabia, Fabia Combi, Fabia Schrägheck, Praktik, Roomster
0 265 234 722	VW (VOLKSWAGEN)	Fox
0 265 234 749	IVECO	Daily
0 265 234 751	IVECO	Daily
0 265 234 753	IVECO	Daily
0 265 234 803	RENAULT	Clio III
0 265 235 ...		
0 265 235 001	MERCEDES-BENZ	Viano, Vito
0 265 235 019	JAGUAR	X-Type, X-Type Estate
0 265 235 028	MERCEDES-BENZ	Sprinter
	VW (VOLKSWAGEN)	Crafter 50
0 265 235 044	NISSAN	Note
0 265 235 046	NISSAN	Note
0 265 235 048	NISSAN	Note
0 265 235 060	VAUXHALL	Corsa
0 265 235 066	TOYOTA	Auris
0 265 235 074	HONDA	Civic Hatchback
0 265 235 078	HONDA	Civic Hatchback
0 265 235 080	HONDA	Civic Hatchback
0 265 235 082	HONDA	Civic Hatchback
0 265 235 099	SMART (MCC)	Forfour
0 265 235 102	AUDI	A6, A6 Avant
0 265 235 105	AUDI	A6, A6 Avant
0 265 235 164	VAUXHALL	Corsa
0 265 235 168	MERCEDES-BENZ	Viano, Vito
0 265 235 220	KIA	Carnival
0 265 235 230	FIAT	Panda
0 265 235 232	FIAT	Punto Grande
0 265 235 278	HONDA	Civic Hatchback
0 265 235 280	HONDA	Civic Hatchback
0 265 235 282	HONDA	Civic Hatchback
0 265 235 285	MERCEDES-BENZ	Serie G
0 265 235 292	FIAT	Bravo
0 265 235 303	HONDA	CR-V

		
0 265 235 305	HONDA	CR-V
0 265 235 307	HONDA	CR-V
0 265 235 309	HONDA	CR-V
0 265 235 311	HONDA	CR-V
0 265 235 313	HONDA	CR-V
0 265 235 358	ALFA ROMEO	GT, 147
0 265 235 368	SUZUKI	SX4 Hatchback
0 265 235 393	BENTLEY	Continental Flying Spur, Continental GT/GTC, Continental GT/GTC Speed
0 265 235 395	HONDA	Civic Hatchback
0 265 235 397	HONDA	Civic Hatchback
0 265 235 399	HONDA	Civic Hatchback
0 265 235 407	TOYOTA	Avensis, Avensis Wagon
0 265 235 431	FIAT	Idea
	LANCIA	Musa
0 265 235 433	FIAT	Punto Grande
0 265 235 438	FORD	Transit
0 265 235 441	FORD	Transit, Transit Euroline, Transit Nugget, Transit Tourneo
0 265 235 450	INFINITI	G Coupé
0 265 235 477	SUBARU	Impreza
0 265 235 495	NISSAN	Note
0 265 236 ...		
0 265 236 001	PORSCHE	911, 911 Cabriolet, 911 Targa
0 265 236 003	PORSCHE	911, 911 Cabriolet
0 265 236 013	BMW	Serie X
0 265 236 014	PORSCHE	911
0 265 236 021	BMW	Serie 5, Serie 5 Touring, Serie 6, Serie 6 Cabrio
0 265 236 023	BMW	Serie 5, Serie 5 Touring, Serie 6, Serie 6 Cabrio
0 265 236 025	BMW	Serie 5, Serie 5 Touring
0 265 236 037	PORSCHE	911, 911 Cabriolet, 911 Speedster
0 265 236 039	PORSCHE	Boxster, Cayman
0 265 236 041	PORSCHE	911, 911 Cabriolet, 911 Targa
0 265 236 043	PORSCHE	911
0 265 236 086	AUDI	A4, A4 Avant, A5 Coupé
0 265 236 120	PORSCHE	911
0 265 236 122	PORSCHE	911, 911 Cabriolet
0 265 236 278	LAND ROVER GROUP	Discovery IV, Range Rover IV, Range Rover Sport
0 265 236 381	BMW	Serie 3, Serie 3 Coupé, Serie 3 Touring
0 265 237 ...		
0 265 237 049	SUZUKI	SX4 Hatchback
0 265 237 051	SUZUKI	SX4 Hatchback
0 265 238 ...		
0 265 238 008	HONDA	Civic Hatchback
0 265 238 010	HONDA	Civic Hatchback

de

Hydroaggregat
(Fortsetzung)

en

Hydraulic modulator
(continued)

fr

Groupe hydraulique
(suite)

it

Gruppo idraulico
(seguito)

es

Grupo hidráulico
(continuación)

nl

Hydroaggregaat
(vervolg)

sv

Hydraulaggregat
(fortsättning)

pt

Módulo hidráulico
(continuação)

cs

Hydraulická jednotka
(pokračování)

ru

Гидроагрегат
(продолжение)

0 265 238 012	HONDA	Civic Hatchback
0 265 238 014	HONDA	Civic Hatchback
0 265 238 016	HONDA	Civic Hatchback
0 265 238 018	HONDA	Civic Hatchback
0 265 238 030	HONDA	Civic Hatchback
0 265 238 043	HONDA	CR-V
0 265 238 045	HONDA	CR-V
0 265 238 072	SUZUKI	SX4 Hatchback

0 265 239 ...

0 265 239 002	SEAT	Ibiza, Ibiza SC
0 265 239 490	MERCEDES-BENZ	Serie E, Serie E (Cabrio), Serie E (Coupé), Serie E (T-Modell)

0 265 242 ...

0 265 242 175	TOYOTA	Camry
0 265 242 259	IVECO	Daily

0 265 243 ...

0 265 243 035	NISSAN	Micra
0 265 243 036	NISSAN	Micra
0 265 243 037	NISSAN	Micra
0 265 243 038	NISSAN	Micra
0 265 243 044	NISSAN	Micra
0 265 243 045	NISSAN	Micra
0 265 243 337	FORD	Transit Custom, Transit Tourneo Custom

0 265 251 ...

0 265 251 005	NISSAN	370 Z Coupé
0 265 251 007	NISSAN	370 Z Coupé
0 265 251 176	CITROEN	Jumpy
	PEUGEOT	Expert
0 265 251 298	TOYOTA	Auris
0 265 251 366	VW (VOLKSWAGEN)	Crafter 30, Crafter 35
0 265 251 445	FIAT	500, 500C
0 265 251 447	NISSAN	Altima
0 265 251 449	NISSAN	Altima
0 265 251 460	NISSAN	Altima Coupé
0 265 251 489	TOYOTA	Corolla Verso
0 265 251 491	TOYOTA	Avensis, Avensis Wagon
0 265 251 817	ALFA ROMEO	MiTo
0 265 251 844	FIAT	Bravo
0 265 251 867	RENAULT	Twingo II, Wind
0 265 251 870	OPEL	Corsa
	VAUXHALL	Corsa
0 265 251 871	OPEL	Corsa
	VAUXHALL	Corsa
0 265 251 924	LAND ROVER GROUP	Defender 90, Defender 110, Defender 130

0 265 252 ...

0 265 252 188	DAIHATSU	Cuore
----------------------	----------	-------

**1 267 000 ...**

1 267 000 933	MERCEDES-BENZ	Serie V
----------------------	---------------	---------



F 01G 09D ...



F 01G 09D 0AF	HONDA	Legend
F 01G 09D 0AK	NISSAN	350 Z, 350 Z Cabriolet, 350 Z Coupé
F 01G 09D 0AL	NISSAN	X-Trail
F 01G 09D 0AM	NISSAN	X-Trail
F 01G 09D 0AR	INFINITI	G35
	NISSAN	350 Z Cabriolet, 350 Z Coupé
F 01G 09D 0AV	NISSAN	X-Trail
F 01G 09D 00C	MITSUBISHI	3000 GT
F 01G 09D 00D	MITSUBISHI	Space Runner, Space Wagon
F 01G 09D 00F	MITSUBISHI	Colt, Lancer Station Wagon
F 01G 09D 00H	MITSUBISHI	Galant, Galant Hatchback
F 01G 09D 01B	MAZDA	RX-7 Coupé
F 01G 09D 01M	MAZDA	RX-7 Coupé
F 01G 09D 01N	NISSAN	Serena
F 01G 09D 02C	MITSUBISHI	Pajero, Pajero Cabrio
F 01G 09D 02L	MAZDA	MX-5
F 01G 09D 03E	MAZDA	MX-5
F 01G 09D 03M	NISSAN	Pickup
F 01G 09D 03N	NISSAN	Hardbody, Pickup
F 01G 09D 03P	NISSAN	Hardbody, Pickup
F 01G 09D 03U	NISSAN	Maxima
F 01G 09D 04A	MITSUBISHI	Colt, Lancer, Lancer Evo4, Lancer Sedan
F 01G 09D 04C	MITSUBISHI	Space Runner, Space Wagon
F 01G 09D 005	NISSAN	Pulsar Hatchback
F 01G 09D 05R	NISSAN	Pulsar
F 01G 09D 05S	MAZDA	E-Serie, Serie E
F 01G 09D 06G	NISSAN	Pulsar
F 01G 09D 08H	HONDA	Civic Coupé, Civic Sedan
F 01G 09D 09A	HONDA	Civic Hatchback
F 01G 09D 09H	HONDA	Civic Sedan
F 01G 09D 015	MAZDA	MX-5
F 01G 09D 016	MITSUBISHI	Pajero, Pajero Cabrio
F 01G 09D 019	MITSUBISHI	Space Runner, Space Wagon
F 01G 09D 021	MAZDA	RX-7 Coupé
F 01G 09D 022	MAZDA	RX-7 Coupé
F 01G 09D 024	MITSUBISHI	Pajero, Pajero Cabrio
F 01G 09D 031	NISSAN	Pickup
F 01G 09D 043	NISSAN	Pulsar, Pulsar Hatchback, Pulsar Sedan
F 01G 09D 047	MITSUBISHI	Space Runner, Space Wagon
F 01G 09D 054	MITSUBISHI	Lancer Evo5/6
F 01G 09D 099	HONDA	Civic Hatchback

F 01G 29E ...

F 01G 29E 02L	PROTON	Waja
----------------------	--------	------

de	en	fr	it	es
Steuergerät	ABS ECU	Calculateur électronique ABS	Centralina ABS	Unidad de control ABS
nl	sv	pt	cs	ru
ABS-regelapparaat	ABS-styrenhet	Aparelho de comando ABS	Řídicí jednotka ABS	Блок управления ABS

		
0 265 100 ...		
0 265 100 034	ALFA ROMEO	164
0 265 100 038	AUDI	100
0 265 100 039	OPEL VAUXHALL	Vectra Cavalier III
0 265 100 042	FIAT LANCIA	Marengo, Tempra, Tempra SW, Tipo Dedra Berlina
0 265 100 047	RENAULT	Espace II
0 265 100 048	RENAULT	Espace II
0 265 100 049	BMW	Serie 5, Serie 7
0 265 100 051	ALFA ROMEO	164
0 265 100 054	NISSAN	Primera Hatchback, Primera Sedan
0 265 100 055	BMW	Serie 5, Serie 5 Touring, Serie 7
0 265 100 057	AUDI	Cabriolet, Coupé, 80, 80 Avant, 100, 100 Avant
0 265 100 066	PEUGEOT	605
0 265 100 067	RENAULT	Safrane
0 265 100 069	VW (VOLKS- WAGEN)	LT
0 265 100 072	VW (VOLKS- WAGEN)	California T4, Caravelle T4, Eurovan, Multivan T4, Transporter T4
0 265 100 073	PEUGEOT	405, 405 Break
0 265 100 078	SSANGYONG	Musso
0 265 101 ...		
0 265 101 021	MERCEDES-BENZ	Serie E, Serie E (Cabrio), Serie E (Coupé), Serie E (T-Modell), Serie 190
0 265 101 023	MERCEDES-BENZ	Serie E, Serie E (T-Modell)
0 265 101 028	VOLVO	740, 940, 960
0 265 101 031	VOLVO	940, 960
0 265 101 041	MERCEDES-BENZ	Serie C
0 265 101 045	MERCEDES-BENZ	Serie S
0 265 101 047	MERCEDES-BENZ	Serie CL (Coupé), Serie S, Serie S (Coupé)
0 265 102 ...		
0 265 102 001	MITSUBISHI	Eclipse
0 265 103 ...		
0 265 103 016	OPEL VAUXHALL	Omega Carlton III
0 265 103 034	OPEL VAUXHALL	Omega Carlton III
0 265 103 038	OPEL VAUXHALL	Calibra, Vectra Calibra, Cavalier III
0 265 103 041	BMW	Serie 3 Touring
0 265 103 044	ROLLS-ROYCE	Phantom VI
0 265 103 047	BMW	Serie 5, Serie 5 Touring
0 265 103 051	AUDI	Coupé, Coupé S2, S4, 80 Avant, 100, 100 Avant

		
0 265 103 059	VW (VOLKS- WAGEN)	LT
0 265 103 062	AUDI	S4, 100, 100 Avant
0 265 103 072	HYUNDAI	Grace, H 100
0 265 104 ...		
0 265 104 006	AUDI	Cabriolet, Coupé, 80, 80 Avant, 100, 100 Avant
0 265 105 ...		
0 265 105 015	MERCEDES-BENZ	Serie G
0 265 105 020	IVECO	Daily
0 265 105 022	MERCEDES-BENZ	2t, 3t, 4t
0 265 105 032	JAGUAR	XJ 12
0 265 105 035	FIAT LANCIA	Tempra SW Dedra Berlina, Delta
0 265 105 038	RENAULT	Trafic
0 265 106 ...		
0 265 106 064	MERCEDES-BENZ	Serie S
0 265 106 071	MERCEDES-BENZ	Serie CL (Coupé), Serie S, Serie S (Coupé)
0 265 106 082	MERCEDES-BENZ	Serie SL
0 265 106 094	PEUGEOT	605
0 265 106 097	MERCEDES-BENZ	Serie E
0 265 106 112	MERCEDES-BENZ	Serie E
0 265 106 113	MERCEDES-BENZ	Serie C, Serie E
0 265 106 114	MERCEDES-BENZ	Serie E, Serie E (T-Modell)
0 265 108 ...		
0 265 108 001	PORSCHE	911, 911 Targa
0 265 108 005	AUDI	A4, A4 Avant, A6, A6 Avant
0 265 108 006	BMW	Serie 5, Serie 5 Touring
0 265 108 007	TOYOTA	Carina E Liftback, Carina E Sedan, Carina E Wagon
0 265 108 009	TOYOTA	Carina E Liftback, Carina E Sedan, Carina E Wagon
0 265 108 010	NISSAN	Pulsar Hatchback, Pulsar Sedan
0 265 108 011	BMW	Serie 7
0 265 108 018	MERCEDES-BENZ	Serie C
0 265 108 024	NISSAN	Micra
0 265 108 029	MERCEDES-BENZ	Serie C
0 265 108 036	NISSAN	Micra
0 265 108 041	NISSAN	Micra
0 265 108 045	MG ROVER	ZT, ZT-Tourer 75, 75 Tourer
0 265 109 ...		
0 265 109 002	AUDI	A4, A4 Avant, A6, A6 Avant, A8
0 265 109 009	PORSCHE	911
0 265 109 010	BMW	Serie 5, Serie 5 Touring
0 265 109 011	BMW	Serie 5, Serie 5 Touring
0 265 109 015	BMW	Serie 7
0 265 109 016	BMW	Serie 5, Serie 5 Touring, Serie 7
0 265 109 023	BMW	Serie 5, Serie 5 Touring, Serie 7

de

Steuergerät
(Fortsetzung)

en

ABS ECU
(continued)

fr

Calculateur
électronique ABS
(suite)

it

Centralina ABS
(seguito)

es

Unidad de control ABS
(continuación)

CPU		
0 265 109 024	AUDI	A6, A6 Avant, A8
0 265 109 025	PORSCHE	911, 911 Targa
0 265 109 026	AUDI	A4, A4 Avant, A6, A6 Avant, A8
0 265 109 027	BMW	Serie 7
0 265 109 031	AUDI	A4, A4 Avant, A6, A6 Avant, A8, S6, S6 Avant
0 265 109 035	MERCEDES-BENZ	Serie C
0 265 109 047	DAEWOO	Korando, Musso
	SSANGYONG	Korando, Musso
0 265 109 052	MERCEDES-BENZ	Serie C, Serie E, Serie E (T-Modell), Serie SL
0 265 109 053	MERCEDES-BENZ	Serie C, Serie C (T-Modell), Serie E, Serie E (T-Modell)
0 265 109 054	MERCEDES-BENZ	Serie E, Serie E (T-Modell), Serie S
0 265 109 056	MERCEDES-BENZ	Serie E, Serie E (T-Modell)
0 265 109 057	MERCEDES-BENZ	Serie E, Serie E (T-Modell)
0 265 109 064	MERCEDES-BENZ	Serie E, Serie E (T-Modell)
0 265 109 070	MERCEDES-BENZ	Serie S
0 265 109 071	MERCEDES-BENZ	Serie CL (Coupé), Serie S, Serie S (Coupé)
0 265 109 077	BMW	Serie 5, Serie 5 Touring, Serie 7
0 265 109 089	PEUGEOT	406, 406 Break, 406 Coupé
0 265 109 400	AUDI	A8, S8
0 265 109 402	BMW	Serie 7
0 265 109 411	BMW	Serie 5, Serie 5 Touring
0 265 109 413	BMW	Serie 7
0 265 109 415	PEUGEOT	607
0 265 109 417	PORSCHE	911, 911 Cabriolet, 911 Carrera Cabriolet
0 265 109 426	AUDI	A4, A4 Avant, A6, A6 Avant, S4, S4 Avant
	VW (VOLKS- WAGEN)	Passat, Passat Variant
0 265 109 436	MERCEDES-BENZ	Serie E, Serie E (T-Modell)
0 265 109 440	MERCEDES-BENZ	Serie E (T-Modell)
0 265 109 443	AUDI	A8, S8
0 265 109 444	AUDI	A8
0 265 109 447	MERCEDES-BENZ	Serie S
0 265 109 451	MERCEDES-BENZ	Serie E, Serie E (T-Modell)
0 265 109 459	MERCEDES-BENZ	Classe A, Serie A
0 265 109 460	AUDI	A8, S8
0 265 109 461	AUDI	A8
0 265 109 462	AUDI	A4, A4 Avant, A6, A6 Avant, RS4 Avant, S4, S4 Avant
	VW (VOLKS- WAGEN)	Passat, Passat Variant
0 265 109 463	AUDI	A4, A4 Avant, A6, A6 Avant
	VW (VOLKS- WAGEN)	Passat, Passat Variant
0 265 109 468	MERCEDES-BENZ	Classe A
0 265 109 470	MERCEDES-BENZ	Serie E, Serie E (T-Modell)
0 265 109 471	MERCEDES-BENZ	Serie E (T-Modell)
0 265 109 473	AUDI	S6, S6 Avant
0 265 109 474	AUDI	A8

CPU		
0 265 109 477	MERCEDES-BENZ	Classe A, Serie A
0 265 109 482	MERCEDES-BENZ	Serie C, Serie C (T-Modell)
0 265 109 483	MERCEDES-BENZ	Serie C, Serie C (T-Modell), Serie CLK (Cabrio), Serie CLK (Coupé), Serie E (T-Modell)
0 265 109 484	MERCEDES-BENZ	Serie E, Serie E (T-Modell)
0 265 109 486	MERCEDES-BENZ	Serie E, Serie E (T-Modell)
0 265 109 487	MERCEDES-BENZ	Serie E, Serie E (T-Modell)
0 265 109 488	MERCEDES-BENZ	Serie E, Serie E (T-Modell)
0 265 109 489	MERCEDES-BENZ	Serie E, Serie E (T-Modell)
0 265 109 492	MERCEDES-BENZ	Serie CL (Coupé), Serie S
0 265 109 493	MERCEDES-BENZ	Serie SL
0 265 109 495	MERCEDES-BENZ	Serie G
0 265 109 497	MERCEDES-BENZ	Serie CL (Coupé), Serie S
0 265 109 499	MERCEDES-BENZ	Serie CLK (Coupé), Serie E, Serie E (T-Modell)
0 265 109 509	MERCEDES-BENZ	Serie SLR (Coupé), Serie SLR (Roadster)
0 265 109 538	MERCEDES-BENZ	Serie E, Serie E (T-Modell)
0 265 109 601	MERCEDES-BENZ	Serie S
0 265 109 602	VW (VOLKS- WAGEN)	California T4, Caravelle T4, Eurovan, Multivan T4, Transporter T4
0 265 109 604	NISSAN	Primera, Primera Hatchback, Primera Wagon
0 265 109 605	NISSAN	Primera, Primera Hatchback, Primera Wagon
0 265 109 607	MERCEDES-BENZ	Serie S
0 265 109 609	MERCEDES-BENZ	Serie S
0 265 109 612	VW (VOLKS- WAGEN)	California T4, Caravelle T4, Eurovan, Multivan T4, Transporter T4
0 265 109 613	AUDI	A6 Allroad
0 265 109 617	MERCEDES-BENZ	Vaneo
0 265 109 620	NISSAN	Primera, Primera Hatchback, Primera Wagon
0 265 109 621	NISSAN	Primera, Primera Hatchback, Primera Wagon
0 265 109 622	NISSAN	Primera, Primera Hatchback, Primera Wagon
0 265 109 623	NISSAN	Primera, Primera Hatchback, Primera Wagon
0 265 109 624	NISSAN	Primera, Primera Hatchback, Primera Wagon
0 265 109 625	MERCEDES-BENZ	Serie G
0 265 109 629	PEUGEOT	607
0 265 109 630	MERCEDES-BENZ	Classe A, Serie A
0 265 109 741	NISSAN	X-Trail
0 265 109 743	MERCEDES-BENZ	Serie S
0 265 109 745	MERCEDES-BENZ	Serie CL (Coupé), Serie S
0 265 109 746	MERCEDES-BENZ	Serie CL (Coupé)
0 265 109 750	NISSAN	Primera, Primera Hatchback, Primera Wagon
0 265 109 765	MERCEDES-BENZ	Serie G

nl

ABS-regelapparaat
(vervolg)

sv

ABS-styrenhet
(fortsättning)

pt

Aparelho de comando
ABS
(continuação)

cs

Řídicí jednotka ABS
(pokračování)

ru

Блок управления
ABS
(продолжение)



0 273 004 ...

0 273 004 044	ROVER	Serie 200, Serie 400 Tourer
0 273 004 088	PEUGEOT	405
0 273 004 093	PEUGEOT	406, 406 Break, 406 Coupé
0 273 004 112	CITROEN	Berlingo
	PEUGEOT	Partner, Ranch
0 273 004 174	DAEWOO	New Prince
0 273 004 181	LADA	Serie 110

1 267 000 ...

1 267 000 814	MERCEDES-BENZ	MB
	SSANGYONG	Istana
1 267 000 817	PEUGEOT	605
1 267 000 820	PEUGEOT	406, 406 Break, 406 Coupé
1 267 000 821	CITROEN	ZX
	PEUGEOT	306, 306 Cabriolet
1 267 000 826	MG	ZR, ZS
	ROVER	Serie 200, Serie 400, Serie 400 Coupé, Serie 400 Tourer
1 267 000 827	MG	MG TF, MGF
1 267 000 828	CITROEN	ZX
	PEUGEOT	306, 306 Cabriolet
1 267 000 831	HONDA	Accord Sedan
	ROVER	Serie 600

1 273 004 ...

1 273 004 168	CITROEN	Jumper
	FIAT	Ducato 10, Ducato 14
	PEUGEOT	Boxer
1 273 004 206	CADILLAC	Catera
1 273 004 227	OPEL	Corsa
1 273 004 229	TOYOTA	Avensis, Avensis Liftback, Avensis Wagon
1 273 004 238	ROVER	Serie 400, Serie 400 Coupé, Serie 400 Tourer
1 273 004 242	FIAT	Barchetta
1 273 004 247	MG	ZS
	ROVER	Serie 200, Serie 400, Serie 400 Coupé, Serie 400 Tourer, 25, 45
1 273 004 249	DAEWOO	Leganza
1 273 004 251	DAEWOO	Leganza
1 273 004 260	FORD	Transit, Transit Euroline, Transit Nugget, Transit Tourneo
1 273 004 278	CITROEN	Xsara Break
1 273 004 290	FIAT	Fiorino
1 273 004 323	SUZUKI	Swift, Swift Hatchback
1 273 004 340	FORD	Transit, Transit Euroline, Transit Nugget, Transit Tourneo
1 273 004 397	MG	ZS
	ROVER	Serie 200, Serie 400, Serie 400 Coupé, Serie 400 Tourer, 25, 45



1 273 004 406	RENAULT	Espace III
1 273 004 426	FIAT	Seicento
1 273 004 483	ALFA ROMEO	156 Berlina, 156 Sport Wagon
1 273 004 505	NISSAN	Almera Tino
1 273 004 506	NISSAN	Almera Tino
1 273 004 559	TOYOTA	Avensis, Avensis Liftback, Avensis Wagon
1 273 004 571	TOYOTA	Corolla, Corolla RunX
1 273 004 599	OPEL	Omega
	VAUXHALL	Omega

2 267 000 ...

2 267 000 704	RENAULT	Clio I
2 267 000 709	ROVER	Serie 200, Serie 400, Serie 400 Tourer
2 267 000 732	PEUGEOT	405, 405 Break
2 267 000 734	PEUGEOT	405, 405 Break
2 267 000 735	CITROEN	ZX
	PEUGEOT	306, 306 Cabriolet
2 267 000 738	RENAULT	Safrane
2 267 000 739	RENAULT	Clio I
2 267 000 740	CITROEN	ZX
2 267 000 745	ROVER	Serie 800

F 01G 09E ...

F 01G 09E 00E	MITSUBISHI	Space Wagon
F 01G 09E 00L	MITSUBISHI	Space Wagon
F 01G 09E 00W	ISUZU	Trooper
F 01G 09E 02L	NISSAN	X-Trail
F 01G 09E 02T	NISSAN	X-Trail
F 01G 09E 02V	NISSAN	X-Trail
F 01G 09E 02Y	NISSAN	Sunny Hatchback, Sunny Sedan
F 01G 09E 006	MITSUBISHI	Space Runner, Space Wagon
F 01G 09E 007	MITSUBISHI	Space Runner, Space Wagon
F 01G 09E 012	MITSUBISHI	Galant, Galant Hatchback

de

Beschleunigungs-
sensor

en

Acceleration
sensor

fr

Capteur
d'accélération

it

Sensore
accelerazione

es

Captador
de aceleración

nl

Acceleratie-
sensor

sv

Accelerations-
givare

pt

Sensor
de aceleração

cs

Snímač
zrychlení

ru

Датчик
ускорения



0 265 002 ...

0 265 002 230	MERCEDES- BENZ	Serie G
----------------------	-------------------	---------

0 265 005 ...

0 265 005 030	ALFA ROMEO	155
----------------------	------------	-----

	FIAT	Tempra SW
--	------	-----------

0 265 005 031	ALFA ROMEO	155
----------------------	------------	-----

	FIAT	Tempra SW
--	------	-----------

0 265 005 038	RENAULT	Espace II
----------------------	---------	-----------

0 265 005 040	MERCEDES- BENZ	Serie G
----------------------	-------------------	---------

0 265 005 041	CHEVROLET	Corvette Cabrio, Corvette Coupé
----------------------	-----------	------------------------------------

	RENAULT	Alpine
--	---------	--------

0 265 005 107	MERCEDES- BENZ	Serie E, Serie S, Serie S (Coupé), Serie SL
----------------------	-------------------	--

0 265 005 108	PORSCHE	911, 968
----------------------	---------	----------

0 265 005 111	PEUGEOT	405, 405 Break
----------------------	---------	----------------

	RENAULT	Safrane
--	---------	---------

0 265 005 125	SSANGYONG	Korando, Musso, Rexton
----------------------	-----------	------------------------------

0 265 005 142	KIA	Sorento
----------------------	-----	---------

0 265 005 146	UAZ	Hunter, Patriot, Pickup
----------------------	-----	-------------------------------

0 265 005 162	AUDI	A4, A4 Avant, A8, RS4 Avant, S4, S4 Avant, S8
----------------------	------	---

0 265 005 231	MERCEDES- BENZ	Serie CLK (Cabrio)
----------------------	-------------------	--------------------

0 265 005 600	SMART (MCC)	Forfour
----------------------	-------------	---------

F 01G 065 ...

F 01G 065 02A	NISSAN	Pickup
----------------------	--------	--------

F 01G 065 02B	NISSAN	Pickup
----------------------	--------	--------

F 01G 065 02C	NISSAN	Patrol GR, Safari
----------------------	--------	-------------------

F 01G 065 02D	NISSAN	Patrol GR, Safari
----------------------	--------	-------------------

F 01G 065 029	NISSAN	NP300, Pickup
----------------------	--------	---------------

de

Drehratensensor

en

Yaw sensor

fr

Capteur de lacet

it

Sensore imbardata

es

Sensor de rango de giro

nl

Hoeksnelheidssensor

sv

Girsensor

pt

Sensor de rotações

cs

Snímač otáčení vozidla kolem svislé osy

ru

Датчик частоты вращения



0 265 005 ...

0 265 005 201	MERCEDES-BENZ	Serie A, Serie C, Serie C (T-Modell), Serie CL (Coupé), Serie CLK (Cabrio), Serie CLK (Coupé), Serie E, Serie E (T-Modell), Serie S, Serie S (Coupé), Serie SL
0 265 005 207	AUDI	A4, A4 Avant, A6, A6 Avant, A8, RS4 Avant, S4, S4 Avant, S8
	VW (VOLKSWAGEN)	Passat, Passat Variant
0 265 005 214	AUDI	A4, A4 Avant, A6, A6 Allroad, A6 Avant, RS4 Avant, S4, S4 Avant, S6, S6 Avant
	VW (VOLKSWAGEN)	California T4, Caravelle T4, Eurovan, Multivan T4, Passat, Passat Variant, Transporter T4
0 265 005 236	FORD	Mondeo, Mondeo III, Mondeo III Turnier
0 265 005 241	ALFA ROMEO	GT, 147, 156 Berlina, 156 Sport Wagon, 156 Sport Wagon Q4, 156 Sportwagon, 166
	FIAT	Idea, Multipla, Panda, Punto, Punto Van, Stilo, Stilo Multi Wagon
	LANCIA	Musa
0 265 005 248	ALPINA (B. BOVEN-SIEPEN KG)	Roadster
	BMW	Serie X, Serie Z, Serie 3, Serie 3 Touring, Serie 5, Serie 5 Touring, Serie 7
	LAND ROVER GROUP	Range Rover III
0 265 005 252	AUDI	A4, A4 Avant, A4 Cabriolet, A6, A6 Avant, A8, RS6, RS6 Avant, S4, S4 Avant, S4 Cabriolet, S6, S6 Avant, S8
	BENTLEY	Continental Flying Spur, Continental GT, Continental GT Speed, Continental GTC
	SEAT	Cordoba, Ibiza
	SKODA	Fabia, Fabia Combi, Fabia Schrägheck, Superb
	VW (VOLKSWAGEN)	Passat, Passat Variant, Phaeton, Polo, Polo Limousine
0 265 005 253	PEUGEOT	406, 406 Break, 406 Coupé
0 265 005 254	MAZDA	MX-5

0 265 005 258	MERCEDES-BENZ	Classe A, Serie A, Serie CL (Coupé), Serie E, Serie E (T-Modell), Serie G, Serie S, Serie SL, Serie SLR (Coupé), Vaneo, Viano, Vito
0 265 005 262	HOLDEN	Astra
	OPEL	Astra, Astra Cabrio, Astra Caravan, Astra Coupé, Meriva, Zafira
	VAUXHALL	Astra, Astra Convertible, Astra Coupé, Astra Estate, Astra Van, Meriva, Zafira
0 265 005 263	RENAULT	Clio II, Clio III, Clio III Grandtour, Grand Scenic II, Megane I, Megane I Classic, Megane II, Megane II Cabrio, Megane II Grandtour, Megane II Hatchback, Modus, Scenic I, Scenic II, Thalia
0 265 005 265	NISSAN	Micra, Micra CC, Note, Primera, Primera Hatchback, Primera Wagon
0 265 005 266	BMW	Serie 5, Serie 5 Touring, Serie 6, Serie 6 Cabrio
0 265 005 270	OPEL	Corsa, Meriva, Tigra TwinTop
	VAUXHALL	Corsa, Meriva, Tigra TwinTop
0 265 005 273	TOYOTA	Avensis, Avensis Liftback, Avensis Wagon, Corolla Hatchback
0 265 005 277	ALFA ROMEO	166
0 265 005 285	ALPINA (B. BOVEN-SIEPEN KG)	B7
	BMW	Serie X, Serie 5, Serie 5 Touring, Serie 6, Serie 6 Cabrio, Serie 7
	ROLLS-ROYCE	Phantom, Phantom Coupé, Phantom Drophead
0 265 005 290	CITROEN	Berlingo, C8, Xsara, Xsara Break, Xsara Coupé, Xsara Picasso
	FIAT	Ulysse
	LANCIA	Phedra
	PEUGEOT	Partner, 307, 307 Break/SW, 307 CC, 406, 406 Break, 406 Coupé, 607, 807
0 265 005 297	TOYOTA	Avensis, Avensis Liftback, Avensis Wagon, Corolla, Corolla Hatchback, Corolla Verso, Corolla Wagon
0 265 005 601	AUDI	A6 Avant
0 265 005 606	CITROEN	C4, C4 Coupé, C8, Jumpy
	LANCIA	Phedra
	PEUGEOT	Expert, 307, 307 Break/SW, 307 CC, 607, 807
0 265 005 607	FIAT	500, 500C

de

Drehratensensor
(Fortsetzung)

en

Yaw sensor
(continued)

fr

Capteur de lacet
(suite)

it

Sensore imbardata
(seguito)

es

**Sensor de rango
de giro**
(continuación)

0 265 005 619	AUDI	A4, A4 Avant, A6, A6 Avant, RS6 Avant, R8, S4, S4 Avant
0 265 005 621	AUDI	A4, A4 Avant, A4 Cabriolet, RS4, RS4 Avant, RS4 Cabriolet, R8, S4, S4 Avant, S4 Cabriolet
0 265 005 628	MERCEDES-BENZ	Serie G, Viano, Vito
0 265 005 639	FORD	Mondeo III, Mondeo III Turnier
	LAND ROVER GROUP	Discovery III, Range Rover III, Range Rover Sport
0 265 005 651	TOYOTA	Previda
0 265 005 655	LAND ROVER GROUP	Discovery III, Range Rover III, Range Rover Sport
0 265 005 657	OPEL	Corsa, Meriva
	VAUXHALL	Corsa, Meriva
0 265 005 687	MITSUBISHI	Colt, Colt Cabrio
0 265 005 690	FORD	Transit, Transit Euroline, Transit Nugget, Transit Tourneo
0 265 005 692	AUDI	A4, A4 Avant, A6, A6 Allroad, A6 Avant, S4, S4 Avant, S6, S6 Avant
	SEAT	Cordoba, Ibiza
	SKODA	Fabia, Fabia Combi, Fabia Schrägheck, Praktik, Roomster
	VW (VOLKSWAGEN)	Fox, Polo, Polo Limousine
0 265 005 693	INFINITI	G, M
0 265 005 701	RENAULT	Kangoo II, Twingo II
0 265 005 705	SUBARU	Forester, Impreza, Impreza Sedan, Impreza WRX STI, Impreza WRX STI Hatchback, Impreza WRX Wagon
0 265 005 711	BMW	Serie X, Serie 3, Serie 3 Coupé, Serie 3 Touring, Serie 5, Serie 5 Touring, Serie 6, Serie 6 Cabrio
0 265 005 712	BMW	Serie X, Serie 5, Serie 5 Touring, Serie 6, Serie 6 Cabrio
0 265 005 713	BMW	Serie X, Serie Z, Serie 3, Serie 3 Coupé, Serie 3 Touring
0 265 005 715	CITROEN	Berlingo, C4, C4 Coupé, C4 Grand Picasso, C4 Picasso, C5, C5 Tourer
	PEUGEOT	Partner, 308, 308 SW
0 265 005 724	CITROEN	Jumpy
	FIAT	Scudo
	PEUGEOT	Expert, 607
0 265 005 727	MERCEDES-BENZ	Serie A, Serie B, Serie SL



0 265 005 739	AUDI	A4, A4 Allroad, A4 Avant, A4 Sportback, A5 Cabriolet, A5 Coupé, A5 Sportback, Q5, RS5 Coupé, S4, S4 Avant, S5 Cabriolet, S5 Coupé, S5 Sportback
0 265 005 741	AUDI	A4, A4 Allroad, A4 Avant, A4 Sportback, A5 Cabriolet, A5 Coupé, A5 Sportback, Q5, RS4 Avant, RS5 Cabriolet, RS5 Coupé, SQ5, S4, S4 Avant, S5 Cabriolet, S5 Coupé, S5 Sportback
0 265 005 749	MERCEDES-BENZ	Serie C (Coupé), Serie CLS (Coupé), Serie CLS (Shooting Brake), Serie E, Serie E (Cabrio), Serie E (Coupe), Serie E (Coupé), Serie E (T-Modell), Serie E (T-Modell), Serie S, Serie S (Coupé), Serie SLR
0 265 005 751	HYUNDAI	Azera, Grandeur, Santa Fe, Sonata
0 265 005 753	MERCEDES-BENZ	Serie A, Serie B, Serie CLS, Serie E, Serie E (T-Modell), Serie SL
0 265 005 758	CITROEN	Berlingo, Xsara Picasso
	PEUGEOT	Partner
0 265 005 765	CITROEN	C4, C4 Coupé, C4 Grand Picasso, C4 Picasso, C4 Sedan, C5, C5 Tourer, C6, C8, DS4, DS5, Jumpy
	FIAT	Scudo
	LANCIA	Phedra
	PEUGEOT	Expert, RCZ, RCZ R, 307, 307 Break/SW, 307 CC, 308, 308 CC, 308 SW, 407, 407 Coupé, 407 SW, 508, 508 RXH SW, 508 SW, 807, 3008, 5008
0 265 005 768	MAZDA	CX-7, MX-5, RX-8
0 265 005 774	MERCEDES-BENZ	Serie G, Sprinter, Viano, Vito
	SMART (MCC)	Fortwo Cabrio, Fortwo Coupé, Fortwo ED Cabrio, Fortwo ED Coupé
	VW (VOLKSWAGEN)	Crafter 30, Crafter 35, Crafter 50

nl

Hoeksnelheidssensor
(vervolg)

sv

Girsensor
(fortsättning)

pt

Sensor de rotações
(continuação)

cs

Snímač otáčení vozidla kolem svislé osy
(pokračování)

ru

Датчик частоты вращения
(продолжение)



0 265 005 777	AUDI	A6, A6 Allroad, A6 Avant, RS6, RS6 Avant, R8, R8 Spyder, R8 Spyder GT, S6, S6 Avant
	BENTLEY	Continental Flying Spur, Continental Flying Spur Speed, Continental GT, Continental GT Speed, Continental GTC, Continental GTC Speed, Continental Supersport, Continental Supersports, Continental Supersports Cabrio, Continental Supersports ISR Cabrio
	SEAT	Exeo, Exeo ST
0 265 005 806	INFINITI	EX, FX, FX50, G, G Cabrio, G Coupé, M, QX50, QX70, Q60 Cabrio, Q60 Coupé
	NISSAN	Teana, 370 Z Coupé, 370 Z Roadster, 370Z Coupé
0 265 005 811	DACIA	Duster
	RENAULT	Duster, Kangoo II, Twingo II, Wind
0 265 005 816	OPEL	Corsa, Meriva
	VAUXHALL	Corsa, Meriva
0 265 005 821	NISSAN	Cube
0 265 005 823	FIAT	Fiorino, Grande Punto, Punto, Punto Evo, Punto Grande, Punto Grande Abarth, Punto Grande Abarth SS, Qubo, Quobo, 500, 500C
	FORD	Ka
0 265 005 828	NISSAN	Altima, Altima Coupé, Maxima
0 265 005 854	TOYOTA	Auris, Camry, Corolla
0 265 005 855	TOYOTA	Avensis, Avensis Wagon, Corolla Verso
0 265 005 858	NISSAN	370 Z Roadster

de

Lenkwinkelsensor

en

Steering angle sensor

fr

Capteur d'angle de braquage

it

Sensore angolo sterzata

es

Sensor de ángulo de dirección

nl

Stuurhoeksensor

sv

Styrvinkelsensor

pt

Sensor do ângulo de viragem

cs

Snímač úhlu řízení

ru

Датчик угла поворота рулевого колеса



0 265 005 ...

0 265 005 404	PEUGEOT	406, 406 Break, 406 Coupé, 607
0 265 005 414	FORD	Mondeo III, Mondeo III Turnier
0 265 005 429	MERCEDES-BENZ	Viano, Vito
0 265 005 432	TOYOTA	Corolla Verso
0 265 005 433	OPEL	Astra Cabrio, Astra Coupé, Zafira
0 265 005 434	VAUXHALL	Zafira
0 265 005 435	HOLDEN	Astra
	OPEL	Astra, Astra Cabrio, Astra Caravan, Astra Coupé, Zafira
	VAUXHALL	Astra, Astra Convertible, Astra Coupé, Astra Estate, Astra Van, Zafira
0 265 005 487	TOYOTA	Avensis, Avensis Liftback, Avensis Wagon, Corolla, Corolla Hatchback, Corolla Verso, Corolla Wagon
0 265 005 504	MITSUBISHI	Colt
0 265 005 543	OPEL	Insignia, Insignia Sports Tourer
	VAUXHALL	Insignia, Insignia Sports Tourer
0 265 005 546	NISSAN	Murano, 370 Z Coupé, 370 Z Roadster
0 265 005 550	MITSUBISHI	Lancer, Lancer EvoX, Lancer Ralliart, Lancer Sportback, Lancer Sportback Ralliart, Outlander
0 265 005 574	MITSUBISHI	i-MiEV, L 200, Pajero Sport

F 01G 09F ...

F 01G 09F 0MT	INFINITI	G35, QX, QX56
	NISSAN	Almera Hatchback, Almera Sedan, Armada, Murano, Primera, Primera Hatchback, Primera Wagon, Teana, Xterra, X-Trail, 350 Z Cabriolet, 350 Z Coupé

F 01G 065 ...

F 01G 065 00X	TOYOTA	Auris, Corolla, Previda
----------------------	--------	-------------------------

de Drucksensor en Pressure sensor fr Capteur de pression it Sensore pressione es Sensor de presión

nl Druksensor sv Trycksensor pt Sensor de pressão cs Snímač tlaku ru Датчик давления

0 265 005 ...		0 265 005 303	
0 265 005 300	MERCEDES-BENZ	Serie CL (Coupé), Serie S (Coupé), Serie SL	SEAT Cordoba, Ibiza VAUXHALL Astra, Astra Convertible, Astra Coupé, Astra Estate, Astra Van, Combo, Corsa, Meriva, Tigra TwinTop, Zafira
0 265 005 303	ALFA ROMEO	GT, 147, 156 Berlina, 156 Sport Wagon, 156 Sport Wagon Q4, 156 Sportwagon, 166	VW (VOLKS- WAGEN) Passat, Passat Variant, Phaeton, Polo
	ALPINA (B. BOVENSIEPEN KG)	B7, Roadster	0 265 005 307 MERCEDES-BENZ
	AUDI	A4, A4 Avant, A4 Cabriolet, A6, A6 Avant, A8, RS6, RS6 Avant, S4, S4 Avant, S4 Cabriolet, S8	Serie C, Serie C (T-Modell), Serie CLK (Cabrio), Serie CLK (Coupé), Serie E, Serie E (T-Modell), Serie SL
	BENTLEY	Continental Flying Spur, Continental Flying Spur Speed, Continental GT, Continental GT Speed, Continental GTC, Continental GTC Speed, Continental Supersport, Continental Supersports, Continental Supersports Cabrio, Continental Supersports ISR Cabrio, Flying Spur	
	BMW	Serie X, Serie Z, Serie 3, Serie 5, Serie 5 Touring, Serie 7	
	FIAT	Bravo, Stilo, Stilo Multi Wagon	
	FORD	Mondeo III, Mondeo III Turnier	
	HOLDEN	Astra	
	LAND ROVER GROUP	Range Rover III	
	MERCEDES-BENZ	Classe A, Serie A, Serie CL (Coupé), Serie CLK (Cabrio), Serie CLK (Coupé), Serie E, Serie E (T-Modell), Serie S, Vaneo	
	OPEL	Astra, Astra Cabrio, Astra Caravan, Astra Coupé, Combo, Corsa, Meriva, Tigra TwinTop, Zafira	
	ROLLS-ROYCE	Phantom, Phantom Coupé, Phantom Drophead	
	SAAB (SAAB AUTOMOBILE AB)	9-5, 9-5 Kombi	

de

Verwendungsteil**Benutzerhinweise**

In diesem Katalog sind die Daten von Fahrzeugen, Motoren und Geräten für den europäischen Markt von Baujahr 1994 bis einschließlich 2015 erfasst. Diese wurden aus Hersteller- und Importeurangaben, aus Fahrzeuguntersuchungen sowie aus Unterlagen von Bosch nach bestem Wissen sorgfältig zusammengestellt und geben den Stand zum Zeitpunkt der Drucklegung wieder.

Zwangsläufige Abweichungen durch länderspezifische technische Änderungen können nie ganz ausgeschlossen werden. Bosch kann daher insoweit nicht für die Vollständigkeit und Fehlerfreiheit der Daten haften. Für Irrtümer und Druckfehler, die zu Schäden am Eigentum oder Vermögen führen, haftet Bosch nur bei grob fahrlässiger Pflichtverletzung und bei Vorsatz für unmittelbare Schäden. Bei Personenschäden haftet Bosch auch bei leichter Fahrlässigkeit.

en

Applications**Notes for users**

This catalog contains the data from the vehicles, engines, and equipment for the European market from year of manufacture 1994 up to and including the year 2015. This data has been assembled from information provided by manufacturers and importers, and taken from Bosch documentation, as well as from investigations made on vehicles. It has been compiled to the best of our knowledge and belief, and reflects the status at the date of going to print.

Inevitable deviations due to country-specific technical changes can never be completely excluded. Therefore, Bosch in this respect cannot be responsible for the completeness and accuracy of the data. For mistakes and misprint, which lead to damage of property or fortune, Bosch is also liable only in case of grossly negligent violation of duties and in case of intention for direct damage. In case of personal injury, Bosch is also liable concerning slight negligence.

fr

Affectations**A l'attention de l'utilisateur**

Le présent catalogue mentionne les données spécifiques de véhicules, moteurs et appareils pour le marché européen depuis l'année de fabrication 1994 jusqu'au millésime 2015 inclus. Ces informations ont été rassemblées soigneusement et en toute impartialité à partir des indications des constructeurs et importateurs, des contrôles techniques des véhicules et de la documentation Bosch, et matérialisent le stade des connaissances au moment de la mise sous presse.

Des écarts inévitables ne peuvent jamais être complètement exclus en raison des différences spécifiques à chaque pays. Bosch ne peut donc pas à cet égard être tenu responsable de l'exactitude des données. Pour des erreurs et fautes d'impression, qui causeraient des dégâts matériels, Bosch est responsable seulement en cas de violation de ses obligations par faute lourde intentionnelle en ce qui concerne les dommages matériels. En cas de dommages corporels, Bosch peut être également tenu pour responsable dans les cas de faute légère.

it

Impiego**Avvertenze per la consultazione**

Nella seguente parte di catalogo sono contemplati veicoli, motori ed apparecchi a partire dall'anno di costruzione 1994 fino all'anno 2015. Tali informazioni sono state rilevate dalle documentazioni di Case Auto, Importatori, da verifiche eseguite sui veicoli, così come da documentazione Bosch.

Eventuali discordanze, dovute a variazioni delle caratteristiche tecniche per specifici Paesi, non possono essere contemplate. Bosch non potrà quindi essere considerata responsabile per mancanze o inesattezze dei dati. Per eventuali danni a cose o danni patrimoniali, dovuti ad errori o refusi di stampa, Bosch è responsabile solo in caso di dolo o colpa grave. In caso di danni alla persona, Bosch è responsabile anche in caso di colpa meno grave.

es

Aplicación**Instrucciones para el usuario**

Los datos de este catálogo para vehículos, motores y utensilios del mercado europeo comprenden los años de construcción desde 1994 hasta 2015 inclusive. Éstos son creados para la edición indicada sobre la base de documentos de Bosch, exámenes o inspecciones de vehículos así como datos de fabricantes e importadores.

Las diferentes especificaciones técnicas propias de cada país nunca pueden ser excluidas completamente. Por lo tanto, Bosch en este aspecto, no puede ser responsable de la absoluta exactitud de los datos. En el caso de errores, incluidos los de imprenta, que generen daños ó pérdidas de la propiedad o posesiones, Bosch es responsable únicamente en los casos de violación negligente de sus obligaciones y en el supuesto de intención o dolo para el daño directo. Bosch está también obligado a responder en casos de injurias personales por negligencia.

nl

Gebruiksdeel**Gebruikersinstructies**

In deze catalogus zijn de gegevens van voertuigen, motoren en apparaten voor de Europese markt vanaf bouwjaar 1994 tot en met bouwjaar 2015 opgenomen. Deze zijn naar eer en geweten zorgvuldig samengesteld uit fabrikant- en importeursgegevens, voertuig-onderzoek alsmede informatie van Bosch en geven de stand op het tijdstip van publicatie weer.

Landspecifieke afwijkingen zijn echter onvermijdelijk en niet geheel uit te sluiten. Derhalve kan Bosch niet verantwoordelijk worden gehouden voor de volledigheid en het foutloos zijn van deze gegevens. Indien aperte onjuistheden of drukfouten leiden tot directe vermogensschade of directe schade aan eigendommen is Bosch slechts aansprakelijk in geval van grove nalatigheid of opzettelijk handelen. Indien aperte onjuistheden of drukfouten leiden tot letselschade is Bosch aansprakelijk in geval van toerekenbare tekortkoming, die zowel verwijtbaar is als voor haar risico komt.

sv

Användningsdel**Användarvägledning**

I denna katalog finns data angivna för fordon, motorer och apparater för den europeiska marknaden från årsmodell 1994 till och med 2015. Uppgifterna kommer från tillverkarna och importörerna, från fordonsundersökningar och från underlag från Bosch och är omsorgsfullt sammanställda enligt tillgänglig kunskap och anger läget vid tryckningstidpunkten.

I vissa länder kan specifika avvikelser förekomma p. g. a. tekniska ändringar varför Bosch ej kan hållas ansvarig för ej komplett information. Vid fel som leder till direkt skada på egendom eller fordon, kan Bosch hållas ansvarig endast om grov oaktsamhet kan påvisas. Vid personskador kan Bosch hållas ansvarig om vårdslöshet kan påvisas.

pt

Parte de utilização**Instruções para o utilizador**

Este catálogo abrange os dados de veículos, motores e aparelhos para o mercado europeu, fabricados entre 1994 e 2015, inclusive. Estes mesmos dados foram recolhidos conscienciosamente a partir de indicações de fabricantes e importadores, inspeções a veículos e documentos da Bosch e reflectem o estado da técnica por altura da ida para a tipografia.

Não é, de todo, possível excluir a existência de discrepâncias decorrentes de alterações técnicas específicas dos diversos países. Nesta medida, a Bosch não pode garantir que os dados sejam completos e isentos de erros. A Bosch não se responsabiliza por erros, omissões e erros de impressão, que conduzam a perdas e danos, excepto nos casos de danos resultantes directamente de negligência grave ou dolo. Em caso de danos pessoais, a Bosch responsabiliza-se também por danos resultantes de negligência simples.

cs

Použití**Pokyny pro uživatele**

V tomto katalogu jsou obsaženy údaje vozidel, motorů a přístrojů pro evropský trh od roku výroby 1994 do roku 2015 včetně. Tyto údaje byly pečlivě sestaveny podle nejlepšího vědomí z údajů výrobců a dovozců automobilů a zachycují stav k datu předání do tisku.

Odchytky, způsobené technickými změnami specifickými pro některé země, není možné vyloučit. Proto nemůže firma Bosch ručit za úplnost a bezchybnost těchto údajů. Za omyly a chyby tisku, které by způsobily škodu na vlastnictví nebo majetku, ručí firma Bosch jen v případě hrubého a nedbalého porušení povinností a úmyslu bezprostřední škody. Pokud by měly za následek škody na zdraví osob, nese firma Bosch odpovědnost i v případě mírné nedbalosti.

ru

Применение**Вниманию пользователей**

В настоящем каталоге приводятся данные по автомобилям, двигателям и прочему оборудованию на европейском рынке с 1994 по 2015 год выпуска включительно. Они были тщательно подобраны из информации, предоставленной производителями и импортерами, по результатам тестирования автомобилей, а также из документации компании Bosch и отражают состояние на момент подписания в печать. Неизбежные расхождения из-за специфических для каждой страны технических модификаций не могут быть полностью исключены. Поэтому компания Bosch не несет ответственность за полноту и точность предоставленных данных. В случае, если ошибки или опечатки привели к ущербу для собственности или повлекли материальные затраты, компания Bosch принимает на себя ответственность только если это является преднамеренным вредом или грубой небрежностью со стороны фирмы Bosch. Если пострадало физическое лицо, фирма Bosch несет ответственность даже при допущении незначительной небрежности.

de

Hinweise zur Benutzung

en

Instructions for use

fr

Conseils d'utilisation

it

Avvertenze per l'utilizzo

es

Indicaciones de uso

de

B2 | ALFA ROMEO



ALFA ROMEO									
Brera [939]									
1.8 Tbi	05.09→	147		LLE	0986 480 858	25,4			
2.0 JTDM	05.09→	125			0986 480 858	25,4			
2.2 JTS	01.06-09.06	136	Fg.-Nr. →5008406	LLE	0986 480 993	25,4			
	10.06→	136	Fg.-Nr. 5008407→	LLE	0986 480 858	25,4			
2.4 JTDM 20V	04.06-09.06	147	Fg.-Nr. →5008406	LLE	0986 480 993	25,4			
	10.06→	147	Fg.-Nr. 5008407→	LLE	0986 480 858	25,4			
	05.07→	154	Fg.-Nr. 5008407→	LLE	0986 480 858	25,4			
3.2 JTS 24V	03.08→	195	Fg.-Nr. 5008407→	LLE	0986 480 858	25,4			
3.2 JTS 24V Q4	01.06-09.06	191	Fg.-Nr. →5008406	LLE	0986 480 993	25,4			
	10.06→	191	Fg.-Nr. 5008407→	LLE	0986 480 858	25,4			
2.2 JTS	01.06→	136		HAG	0986 486 589	34			
2.4 JTDM 20V	04.06→	147/154		MG6	0986 486 591	34			
3.2 JTS 24V, JTS 24V Q4	01.06→	191/195			0986 486 579	34			
GT [937]									
1.8 TS	10.06→	106		LLE	0986 480 988	22,2			
1.9 JTD 16V	10.06→	110/125		LLE	0986 480 988	22,2			
2.0 JTS	10.06→	120/121		LLE	0986 480 988	22,2	0 204 104 208		
1.8 TS	10.03→	106		LLE	0986 486 084	15,87			
1.9 JTD 16V	10.03→	110/125		LLE	0986 486 084	15,87			
2.0 JTS	10.03→	120/121		LLE	0986 486 084	15,87			
3.2 V6	10.03→	176		LLE	0986 486 084	15,87			
1.9 JTD 16V	10.03→	110/125			0986 486 573	20,6			
3.2 V6	10.03→	176			0986 486 573	20,6			
1.8 TS	10.03-11.05	106	Ricam.Nr →0045014		0265 222 043 ^B				
					0265 225 399 ^T				
	12.05-10.06	106	Ricam.Nr 0045015→		0265 234 259 ^T				
	12.05→	106	Ricam.Nr 0045015→		0265 231 633 ^B				
	11.06→	106			0265 235 358 ^T				
1.9 JTD 16V	10.03-11.05	110	Ricam.Nr →0045014		0265 222 043 ^B				
					0265 225 399 ^T				
	12.05-10.06	110	Ricam.Nr 0045015→		0265 234 259 ^T				
	12.05→	110	Ricam.Nr 0045015→		0265 231 633 ^B				
	11.06→	110			0265 235 358 ^T				
	10.07→	125			0265 235 358 ^T				
2.0 JTS	10.03-11.05	120/121	Ricam.Nr →0045014		0265 222 043 ^B				
					0265 225 399 ^T				
	12.05-10.06	120/121	Ricam.Nr 0045015→		0265 234 259 ^T				
	12.05→	120/121	Ricam.Nr 0045015→		0265 231 633 ^B				
	11.06→	120/121			0265 235 358 ^T				
3.2 V6	10.03→	176			0265 225 399 ^T				
1.8 TS	10.03→	106			0265 005 241				
1.9 JTD 16V	10.03→	110/125			0265 005 241				
2.0 JTS	10.03→	120/121			0265 005 241				
3.2 V6	10.03→	176			0265 005 241				
1.8 TS	10.03-11.05	106	Ricam.Nr →0045014		0265 005 303				
1.9 JTD 16V	10.03-11.05	110	Ricam.Nr →0045014		0265 005 303				

Bosch Automotive Aftermarket

2016 | 2017

- ① Fahrzeughersteller
- ② Produktangabe durch Piktogramm
- ③ Modellangaben
- ④ Motorleistung
- ⑤ Einbaueitraum des Produktes
- ⑥ 10-stellige Bestellnummer
- ⑦ Maßangabe
- ⑧ Reparatursatz
- ⑨ Sonderfälle und Bremssysteme
- ⑩ Fahrgestellnummer bzw. Motortyp

en

fr

it

es

① Vehicle brand	① Marque de véhicule	① Marca del veicolo	① Marca de vehículo
② Details of product using Pictogram symbols	② Présentation produit par pictogramme	② Descrizione prodotto con simboli	② Indicación de producto con pictogramas
③ Details of model	③ Spécification modèle	③ Applicazioni	③ Modelo
④ Engine power	④ Puissance moteur	④ Potenza	④ Potencia del motor
⑤ Mounting period	⑤ Période de montage	⑤ Data di produzione	⑤ Fecha de montaje
⑥ 10-digit part number	⑥ Référence à 10 chiffres	⑥ Codice di ordinazione a 10 cifre	⑥ Referencia de pedido de 10 cifras
⑦ Dimensions	⑦ Dimension	⑦ Dimensioni	⑦ Dimensiones
⑧ Repair kit	⑧ Kit de remise en état	⑧ Set riparazione	⑧ Juego de reparación
⑨ Special cases and braking systems	⑨ Cas particuliers/ Systèmes de freinage	⑨ Casi particolari e sistemi frenanti	⑨ Sistema de frenos y casos especiales
⑩ Chassis number or engine type	⑩ Numéro de châssis (type de moteur)	⑩ N° di telaio o tipo di motore	⑩ Número de chasis o número de motor

nl

Gebruiksaanwijzing

sv

Användnings-
vägledning

pt

Notas sobre
a utilização

cs

Pokyny pro
použití

ru

Указания по
применению

nl

B2 | ALFA ROMEO



ALFA ROMEO									
Brera [939]									
1.8 Tbi	05.09→	147		LLE	0986 480 858	25,4			
2.0 JTDM	05.09→	125			0986 480 858	25,4			
2.2 JTS	01.06-09.06	136	Fg.-Nr. →5008406	LLE	0986 480 993	25,4			
	10.06→	136	Fg.-Nr. 5008407→	LLE	0986 480 858	25,4			
2.4 JTDM 20V	04.06-09.06	147	Fg.-Nr. →5008406	LLE	0986 480 993	25,4			
	10.06→	147	Fg.-Nr. 5008407→	LLE	0986 480 858	25,4			
	05.07→	154	Fg.-Nr. 5008407→	LLE	0986 480 858	25,4			
3.2 JTS 24V	03.08→	195	Fg.-Nr. 5008407→	LLE	0986 480 858	25,4			
3.2 JTS 24V Q4	01.06-09.06	191	Fg.-Nr. →5008406	LLE	0986 480 993	25,4			
	10.06→	191	Fg.-Nr. 5008407→	LLE	0986 480 858	25,4			
2.2 JTS	01.06→	136		HAG	0986 486 589	34			
				MG6	0986 486 591	34			
2.4 JTDM 20V	04.06→	147/154			0986 486 579	34			
3.2 JTS 24V, JTS 24V Q4	01.06→	191/195			0986 486 579	34			
GT [937]									
1.8 TS	10.06→	106		LLE	0986 480 988	22,2			
1.9 JTD 16V	10.06→	110/125		LLE	0986 480 988	22,2			
2.0 JTS	10.06→	120/121		LLE	0986 480 988	22,2	0 204 104 208		
1.8 TS	10.03→	106		LLE	0986 486 084	15,87			
1.9 JTD 16V	10.03→	110/125		LLE	0986 486 084	15,87			
2.0 JTS	10.03→	120/121		LLE	0986 486 084	15,87			
3.2 V6	10.03→	176		LLE	0986 486 084	15,87			
1.9 JTD 16V	10.03→	110/125			0986 486 573	20,6			
3.2 V6	10.03→	176			0986 486 573	20,6			
1.8 TS	10.03-11.05	106	Ricam.Nr →0045014		0265 222 043 ^B				
					0265 225 399 ^T				
	12.05-10.06	106	Ricam.Nr 0045015→		0265 234 259 ^T				
	12.05→	106	Ricam.Nr 0045015→		0265 231 633 ^B				
	11.06→	106			0265 235 358 ^T				
1.9 JTD 16V	10.03-11.05	110	Ricam.Nr →0045014		0265 222 043 ^B				
					0265 225 399 ^T				
	12.05-10.06	110	Ricam.Nr 0045015→		0265 234 259 ^T				
	12.05→	110	Ricam.Nr 0045015→		0265 231 633 ^B				
	11.06→	110			0265 235 358 ^T				
	10.07→	125			0265 235 358 ^T				
2.0 JTS	10.03-11.05	120/121	Ricam.Nr →0045014		0265 222 043 ^B				
					0265 225 399 ^T				
	12.05-10.06	120/121	Ricam.Nr 0045015→		0265 234 259 ^T				
	12.05→	120/121	Ricam.Nr 0045015→		0265 231 633 ^B				
	11.06→	120/121			0265 235 358 ^T				
3.2 V6	10.03→	176			0265 225 399 ^T				
1.8 TS	10.03→	106			0265 005 241				
1.9 JTD 16V	10.03→	110/125			0265 005 241				
2.0 JTS	10.03→	120/121			0265 005 241				
3.2 V6	10.03→	176			0265 005 241				
1.8 TS	10.03-11.05	106	Ricam.Nr →0045014		0265 005 303				
1.9 JTD 16V	10.03-11.05	110	Ricam.Nr →0045014		0265 005 303				

Bosch Automotive Aftermarket

2016 | 2017

① Voertuigfabrikant

② Productweergave
d.m.v. pictogrammen

③ Modelgegevens

④ Motorvermogen

⑤ Inbouwperiode
van het product

⑥ 10-cijferig bestelnummer

⑦ Afmetingen

⑧ Reparatieset

⑨ Speciale gevallen
en remsystemen

⑩ Chassisnummer
resp. motortype

sv

pt

cs

ru

① Biltillverkare	① Fabricante do veículo	① Výrobce vozidla	① Марка автомобиля
② Produktuppgifter med piktogram	② Indicação do produto com pictogramas	② Údaj o produktu formou piktogramu	② Изделия, обозначенные пиктограммой
③ Modelldata	③ Indicações do modelo	③ Údaje o modelu	③ Характеристики модели
④ Motoreffekt	④ Potência do motor	④ Výkon motoru	④ Мощность двигателя
⑤ Produktens användningsperiod	⑤ Período de montagem do produto	⑤ Časový interval montáže produktu	⑤ Время установки изделия
⑥ 10-siffrigt artikelnummer	⑥ Referência de 10 números	⑥ 10místné objednáací číslo	⑥ 10-значный номер для заказа
⑦ Mått	⑦ Indicações da medida	⑦ Rozměrový údaj	⑦ Размер
⑧ Reparationssats	⑧ Jogo de reparação	⑧ Sada pro opravu	⑧ Ремонтный комплект
⑨ Specialfall och bromssystem	⑨ Casos especiais e sistemas de travões	⑨ Speciální případy a brzdové systémy	⑨ Особые случаи и тормозные системы
⑩ Chassinummer resp. motortyp	⑩ Número de chassis ou tipo de motor	⑩ Číslo podvozku příp. typ motoru	⑩ Номер шасси или тип двигателя



ALFA ROMEO

















Brera [939]

	1.8 Tbi	05.09-12.10	147		JBH,LLE	0986 480 858	25,4
	2.0 JTDM	02.09-12.10	120/125		JBH	0986 480 858	25,4
	2.2 JTS	01.06-09.06	136	Fg.-Nr. →5008406	JBH,LLE	0986 480 993	25,4
		10.06-12.10	136	Fg.-Nr. 5008407→	JBH,LLE	0986 480 858	25,4
	2.4 JTDM 20V	04.06-09.06	147	Fg.-Nr. →5008406	JBH,LLE	0986 480 993	25,4
		10.06-12.10	147	Fg.-Nr. 5008407→	JBH,LLE	0986 480 858	25,4
		05.07-12.10	154	Fg.-Nr. 5008407→	JBH,LLE	0986 480 858	25,4
	3.2 JTS 24V	03.08-12.10	195	Fg.-Nr. 5008407→	JBH,LLE	0986 480 858	25,4
	3.2 JTS 24V Q4	01.06-09.06	191	Fg.-Nr. →5008406	JBH,LLE	0986 480 993	25,4
		10.06-12.10	191	Fg.-Nr. 5008407→	JBH,LLE	0986 480 858	25,4
	2.0 JTDM	02.09-12.10	120			0986 486 579	34
	2.2 JTS	01.06-12.10	136		HAG	0986 486 589	34
					MG6	0986 486 591	34
	2.4 JTDM 20V	04.06-12.10	147/154			0986 486 579	34
	3.2 JTS 24V, JTS 24V Q4	01.06-12.10	191/195			0986 486 579	34

GT [937]















	1.8 TS	10.06-12.10	103-106		JBH,LLE	0986 480 988	22,2
	1.9 JTD 16V	10.06-12.10	110/125		JBH,LLE	0986 480 988	22,2
	2.0 JTS	10.06-12.10	119/121		JBH,LLE	0986 480 988	22,2
	1.8 TS	10.03-12.10	103-106		LLE	0986 486 084	15,87
	1.9 JTD 16V	10.03-12.10	110/125		LLE	0986 486 084	15,87
	2.0 JTS	10.03-12.10	119/121		LLE	0986 486 084	15,87
	3.2 V6	10.03-12.10	176		LLE	0986 486 084	15,87
	1.9 JTD 16V	10.03-12.10	110/125			0986 486 573	20,6
	3.2 V6	10.03-12.10	176			0986 486 573	20,6
	1.8 TS	10.03-11.05	103-106	Ricam.Nr →0045014		0265 222 043 ^B	
						0265 225 399 ^T	
		12.05-10.06	103-106	Ricam.Nr 0045015→		0265 234 259 ^T	
		12.05-12.10	103-106	Ricam.Nr 0045015→		0265 231 633 ^B	
		11.06-12.10	103-106			0265 235 358 ^T	
	1.9 JTD 16V	10.03-11.05	110	Ricam.Nr →0045014		0265 222 043 ^B	
						0265 225 399 ^T	
		12.05-10.06	110	Ricam.Nr 0045015→		0265 234 259 ^T	
		12.05-12.10	110	Ricam.Nr 0045015→		0265 231 633 ^B	
		11.06-12.10	110			0265 235 358 ^T	
		10.07-12.10	125			0265 235 358 ^T	
	2.0 JTS	10.03-11.05	119/121	Ricam.Nr →0045014		0265 222 043 ^B	
						0265 225 399 ^T	
		12.05-10.06	119/121	Ricam.Nr 0045015→		0265 234 259 ^T	
		12.05-12.10	119/121	Ricam.Nr 0045015→		0265 231 633 ^B	
		11.06-12.10	119/121			0265 235 358 ^T	
	3.2 V6	10.03-12.10	176			0265 225 399 ^T	
	1.8 TS	10.03-12.10	103-106			0265 005 241	
	1.9 JTD 16V	10.03-12.10	110/125			0265 005 241	
	2.0 JTS	10.03-12.10	119/121			0265 005 241	
	3.2 V6	10.03-12.10	176			0265 005 241	



									
	1.8 TS	10.03-11.05	103-106	Ricam.Nr →0045014			0 265 005 303		
	1.9 JTD 16V	10.03-11.05	110	Ricam.Nr →0045014			0 265 005 303		
	2.0 JTS	10.03-11.05	119/121	Ricam.Nr →0045014			0 265 005 303		
	3.2 V6	10.03-11.05	176	Ricam.Nr →0045014			0 265 005 303		
GTV [916]									
									
	1.8 T.S. 16V	05.98-12.00	106		RLE		0 204 123 523	22,22	
	2.0 JTS	04.03-12.05	121		LLE		0 204 123 523	22,22	
					RLE		0 204 123 668		
	2.0 T.S. 16V	04.95-04.98	110		RLE		0 204 122 268	22,22	
		05.98-07.00	114		RLE		0 204 123 523	22,22	
		08.00-12.05	110		RLE		0 204 123 523	22,22	
	2.0 V6 Turbo	05.98-07.98	148		RLE		0 204 122 268	22,22	
		08.98-07.00	148		RLE		0 204 123 523	22,22	
	3.0 V6 24V	08.00-12.05	160		RLE		0 204 123 523	22,22	
	3.2 V6 24V	04.03-12.05	176		RLE		0 204 123 669	22,2	
	1.8 T.S. 16V	05.98-12.00	106		LLE		0 204 125 431^S		
					RLE		0 204 125 730		
	2.0 JTS	04.03-12.05	121		LLE		0 204 125 730		
					LLE,TKO		0 204 051 043^S		
					RLE,TKO		F 009 D01 187		
		ASR 04.03-12.05	121		LLE		0 204 051 040^S		
	2.0 T.S. 16V	04.95-04.98	110		LLE		0 204 125 431^S		
					RLE		F 009 D01 098		
		05.98-07.00	114		LLE		0 204 125 431^S		
					RLE		0 204 125 730		
		08.00-12.05	110		LLE		0 204 125 431^S		
					RLE		0 204 125 730		
	2.0 V6 Turbo	04.95-07.00	148		LLE		0 204 125 431^S		
		08.98-07.00	148		RLE		0 204 125 730		
	3.0 V6 24V	08.00-12.05	160		RLE		0 204 125 730		
	3.2 V6 24V	04.03-12.05	176		LLE		0 204 051 040^S		
					RLE		F 009 D01 097		
	1.8 T.S. 16V	05.98-12.00	106		LLE		F 026 005 095	19	
					RLE		F 026 005 092	19	
	2.0 JTS	04.03-12.05	121		RLE		F 026 005 092	19	
	2.0 T.S. 16V	04.95-07.00	110/114		LLE		F 026 005 095	19	
		04.95-12.05	110/114		RLE		F 026 005 092	19	
	2.0 V6 Turbo	04.95-07.00	148				F 026 005 095	19	
	3.0 V6 24V	11.96-07.00	162				F 026 005 095	19	
		08.00-12.05	160		RLE		F 026 005 092	19	
	3.2 V6 24V	04.03-12.05	176		RLE		F 026 005 092	19	
	1.8 T.S. 16V	05.98-12.00	106				F 026 005 581	25,4	
	2.0 JTS, T.S. 16V	04.95-12.05	110/114/121				F 026 005 581	25,4	
	2.0 V6 Turbo	04.95-07.00	148				F 026 005 580	25,4	
	3.0 V6 24V	11.96-07.00	162				F 026 005 580	25,4	
		08.00-12.05	160				F 026 005 581	25,4	
	3.2 V6 24V	04.03-12.05	176				F 026 005 581	25,4	
	1.8 T.S. 16V	05.98-12.00	106	Ricam.Nr →6063041			0 265 216 532^B		
				Ricam.Nr 6063042→			0 265 216 782^B		
	2.0 JTS	04.03-12.05	121				0 265 216 782^B		
							0 265 220 692^F		
	2.0 T.S. 16V	04.95-04.97	110				0 265 204 004^B		
		05.97-04.98	110				0 265 216 532^B		
		05.98-07.00	114	Ricam.Nr →6063041			0 265 216 532^B		
				Ricam.Nr 6063042→			0 265 216 782^B		

























		S							
ALFA ROMEO GTV [916]									
2.0 T.S. 16V		08.00-12.05	110				0 265 216 782 ^B		
2.0 V6 Turbo		04.95-04.97	148				0 265 204 004 ^B		
		05.97-11.99	148				0 265 216 532 ^B		
		12.99-07.00	148				0 265 216 782 ^B		
		11.96-04.97	162				0 265 204 004 ^B		
3.0 V6 24V		05.97-04.98	162				0 265 216 532 ^B		
		05.98-07.00	162	Ricam.Nr →6063041			0 265 216 532 ^B		
				Ricam.Nr 6063042→			0 265 216 782 ^B		
		08.00-12.05	160				0 265 216 782 ^B		
3.2 V6 24V		04.03-12.05	176				0 265 216 782 ^B		
							0 265 220 692 ^F		
MiTo [955]									
	0.9 i.e.	07.11→	63/74/77		LLE		0 204 123 682	22,2	
		MFD 07.11→	63/74/77		RLE		0 204 123 686	22,2	
		OFD 07.11→	63/74/77		RLE		0 204 123 685	22,2	
1.3 JTD	10.08→	59/62/66/		LLE		0 204 123 684	23,81		
1.3 JTDM		70		RLE		0 204 123 687	23,81		
1.4	08.08→	51/57-58/77		LLE		0 204 123 682	22,2		
1.4 i.e.	MFD 08.08→	51/57-58/77		RLE		0 204 123 686	22,2		
	OFD 08.08→	51/57-58/77		RLE		0 204 123 685	22,2		
1.4 i.e. 16V	08.08→	51/57-58/77		RLE		0 204 123 685	22,2		
1.4 BiFuel, i.e., i.e. Turbo, Turbo, 16V Turbo	MFD 05.08→	88/99-114/120/125				0 204 123 686	22,2		
	OFD 05.08→	88/99-114/120/125				0 204 123 684	23,81		
1.4 Turbo	12.13→	103		TW		0 204 123 682	22,2		
						0 204 123 684	23,81		
						0 204 123 687	23,81		
						0 204 815 013	26,99		
1.6 JTD	08.08→	85/88		LLE		0 204 123 684	23,81		
				RLE		0 204 123 687	23,81		
	0.9 i.e.	07.11→	63/74/77		BSS,LLE	0 204 125 916			
		MFD 07.11→	63/74/77		RLE	0 204 125 852			
		OFD 07.11→	63/74/77		RLE	0 204 777 286			
1.3 JTD	10.08→	59/62/66/		BSS,LLE	0 204 771 794				
1.3 JTDM		70		BSS,LLE	0 204 125 917				
				RLE	0 204 125 853				
1.4, i.e., i.e. 16V	08.08→	51/57-58/70/77		BSS,LLE	0 204 125 916				
				RLE	0 204 125 852				
1.4 BiFuel	10.08→	88/99-114		BSS,LLE	0 204 771 794				
1.4 i.e. Turbo				BSS,LLE	0 204 125 917				
1.4 16V Turbo				RLE	0 204 125 853				
1.4 i.e., i.e. Turbo, Turbo, 16V Turbo	05.08→	110/114/120/125		BSS,LLE	0 204 771 794				
				BSS,LLE	0 204 125 917				
				RLE	0 204 125 853				
				BSS,LLE	0 204 771 794				
1.4 Turbo	12.13→	103		BSS,LLE	0 204 771 794				
				BSS,LLE	0 204 125 917				
				LLE,TW	0 204 771 794				
				RLE	0 204 125 853				
				RLE,TW	0 204 125 853				
					0 204 777 286				
1.6 JTD	08.08→	85/88		BSS,LLE	0 204 771 794				
				BSS,LLE	0 204 125 917				
				RLE	0 204 125 853				
	1.3 JTD	10.08→	66/70			0 986 486 556	20,6		
	0.9 i.e.	07.11→	63/74/77			0 265 232 787 ^B			
		1.3 JTD	10.08-09.11	62/66/70			0 265 251 817 ^T		
			10.08→	62/66/70			0 265 232 787 ^B		

















		S							
1.3 JTDM		12.13→	59				0 265 232 787 ^B		
1.4		10.09→	77				0 265 232 787 ^B		
							0 265 251 817 ^T		
1.4		05.11-09.11	51/57				0 265 251 817 ^T		
1.4 i.e.		05.11→	51/57				0 265 232 787 ^B		
1.4 BiFuel		07.11-09.11	88				0 265 251 817 ^T		
1.4 BiFuel, i.e. Turbo		10.08→	88				0 265 232 787 ^B		
1.4 i.e.		05.08-09.11	110				0 265 251 817 ^T		
		05.08-12.11	110				0 265 232 787 ^B		
1.4 i.e. Turbo		08.08→	114				0 265 230 192 ^T		
							0 265 232 787 ^B		
		10.08→	88				0 265 230 192 ^T		
1.4 i.e. 16V		08.08→	57-58				0 265 230 192 ^T		
							0 265 232 787 ^B		
1.4 Turbo		10.09→	125				0 265 251 817 ^T		
		12.13→	103				0 265 232 787 ^B		
1.4 16V Turbo		10.09→	99-114				0 265 251 817 ^T		
			120				0 265 232 787 ^B		
1.6 JTD		08.08→	88				0 265 232 787 ^B		
					Fg.-Nr. →1022807		0 265 230 192 ^T		
					Fg.-Nr. 1022808→		0 265 251 817 ^T		
		09.08→	85				0 265 232 787 ^B		
Spider [115]									
									
	1.6	01.90-12.94	78				0 204 122 156	22	
	2.0 i.e.	01.90-12.94	88/93				0 204 122 156	22	
	1.6	01.90-12.94	78				0 986 486 504	25,4	
	2.0 i.e.	01.90-12.94	88/93				0 986 486 504	25,4	
Spider [916]									
									
	1.8 T.S. 16V	05.98-07.00	106			RLE	0 204 123 523	22,22	
	2.0 JTS	04.03-02.06	121			LLE	0 204 123 523	22,22	
						RLE	0 204 123 668		
	2.0 T.S. 16V	04.95-04.98	110			RLE	0 204 122 268	22,22	
		05.98-07.00	114			RLE	0 204 123 523	22,22	
		08.00-02.06	110			RLE	0 204 123 523	22,22	
	2.0 V6 Turbo	04.98-12.00	147			RLE	0 204 123 523	22,22	
	3.0 V6 12V	04.95-04.98	141			RLE	0 204 122 268	22,22	
	3.0 V6 24V	08.00-03.03	160			RLE	0 204 123 523	22,22	
	3.2 V6 24V	04.03-02.06	176			RLE	0 204 123 669	22,2	
	1.8 T.S. 16V	05.98-07.00	106			LLE	0 204 125 431 ^S		
						RLE	0 204 125 730		
	2.0 JTS	04.03-02.06	121			LLE	0 204 125 730		
						RLE,FKØ	F 009 D01 187		
		ASR 04.03-02.06	121			LLE	0 204 051 040 ^S		
						RLE	F 009 D01 096		
	2.0 T.S. 16V	04.95-04.98	110			LLE	0 204 125 431 ^S		
						RLE	F 009 D01 098		
		05.98-07.00	114			LLE	0 204 125 431 ^S		
						RLE	0 204 125 730		
		08.00-02.06	110			LLE	0 204 125 431 ^S		
						RLE	0 204 125 730		
	2.0 V6 Turbo	04.98-12.00	147			LLE	0 204 125 431 ^S		
						RLE	0 204 125 730		
	3.0 V6 12V	04.95-04.98	141			LLE	0 204 125 431 ^S		
						RLE	F 009 D01 098		



















		S							
ALFA ROMEO Spider [916]									
		3.0 V6 24V	08.00-03.03	160		RLE	0 204 125 730		
		3.2 V6 24V	04.03-02.06	176		LLE	0 204 051 040 ^S		
						RLE	F 009 D01 097		
		1.8 T.S. 16V	05.98-07.00	106		LLE	F 026 005 095	19	
						RLE	F 026 005 092	19	
		2.0 JTS	04.03-02.06	121			F 026 005 095	19	
						RLE	F 026 005 092	19	
		2.0 T.S. 16V	04.95-04.98	110		LLE	F 026 005 095	19	
						RLE	F 026 005 092	19	
			05.98-07.00	114		LLE	F 026 005 095	19	
						RLE	F 026 005 092	19	
			08.00-02.06	110			F 026 005 095	19	
						RLE	F 026 005 092	19	
		2.0 V6 Turbo	04.98-12.00	147			F 026 005 095	19	
		3.0 V6 12V	04.95-08.00	141			F 026 005 095	19	
		1.8 T.S. 16V	05.98-07.00	106			F 026 005 581	25,4	
		2.0 JTS, T.S. 16V	04.95-02.06	110/114/121			F 026 005 581	25,4	
		2.0 V6 Turbo	04.98-12.00	147			F 026 005 580	25,4	
		3.0 V6 12V, V6 24V	04.95-03.03	141/160			F 026 005 580	25,4	
		3.2 V6 24V	04.03-02.06	176			F 026 005 580	25,4	
		1.8 T.S. 16V	05.98-11.99	106			0 265 216 532 ^B		
			12.99-07.00	106			0 265 216 782 ^B		
		2.0 JTS	04.03-02.06	121			0 265 216 782 ^B		
							0 265 220 692 ^F		
		2.0 T.S. 16V	04.95-04.98	110	Ricam.Nr →6034133		0 265 204 004 ^B		
					Ricam.Nr 6034134→		0 265 216 532 ^B		
			05.98-07.00	114	Ricam.Nr →6063041		0 265 216 532 ^B		
					Ricam.Nr 6063042→		0 265 216 782 ^B		
			08.00-02.06	110			0 265 216 782 ^B		
		2.0 V6 Turbo	04.98-11.99	147			0 265 216 532 ^B		
			12.99-12.00	147			0 265 216 782 ^B		
		3.0 V6 12V	04.95-04.98	141	Ricam.Nr →6034133		0 265 204 004 ^B		
					Ricam.Nr 6034134→		0 265 216 532 ^B		
			05.98-11.99	141			0 265 216 532 ^B		
			12.99-08.00	141			0 265 216 782 ^B		
		3.0 V6 24V	08.00-03.03	160			0 265 216 782 ^B		
		3.2 V6 24V	04.03-02.06	176			0 265 216 782 ^B		
							0 265 220 692 ^F		
Spider [939]									
		1.8 Tbi	05.09-12.10	147		JBH,LLE	0 986 480 858	25,4	
		2.0 JTDM	04.09-12.10	120		JBH	0 986 480 858	25,4	
			05.09-12.10	125		JBH,LLE	0 986 480 858	25,4	
		2.2 JTS	03.06-09.06	136	Fg.-Nr. →5008406	JBH,LLE	0 986 480 993	25,4	
			10.06-12.10	136	Fg.-Nr. 5008407→	JBH,LLE	0 986 480 858	25,4	
		2.4 JTDM 20V	03.07-12.10	147/154	Fg.-Nr. 5008407→	JBH,LLE	0 986 480 858	25,4	
		3.2 JTS 24V	03.08-12.10	191	Fg.-Nr. 5008407→	JBH,LLE	0 986 480 858	25,4	
		3.2 JTS 24V Q4	09.06-09.06	191	Fg.-Nr. →5008406	JBH,LLE	0 986 480 993	25,4	
			10.06-12.10	191	Fg.-Nr. 5008407→	JBH,LLE	0 986 480 858	25,4	
		2.0 JTDM	04.09-12.10	120			0 986 486 579	34	
		2.2 JTS	03.06-12.10	136		HAG	0 986 486 589	34	
						MG6	0 986 486 591	34	
		2.4 JTDM 20V	03.07-12.10	147/154			0 986 486 579	34	
		3.2 JTS 24V, JTS 24V Q4	09.06-12.10	191			0 986 486 579	34	

		S							
4C Spider [960]									
									
		10.14→	177				0 204 815 013	26,99	
		10.14→	177				0 204 815 011		
4C [960]									
									
	1.8	08.13→	177				0 204 815 013	26,99	
	1.8	08.13→	177				0 204 815 011		
33 Berlina [907A]									
									
	1.3, I.E.	02.90-10.94	65/66			BSY	0 204 122 182	20,6	
	1.4 I.E.	09.91-09.94	64			BSY	0 204 122 182	20,6	
	1.5 I.E., I.E. 4x4	06.90-10.94	71/74			BSY	0 204 122 182	20,6	
	1.7 I.E., I.E. 4x4, I.E. 16V, I.E. 16V 4x4	01.90-10.94	77/95-97			BSY	0 204 122 182	20,6	
	1.8 D Turbo	02.90-10.94	62			BSY	0 204 122 182	20,6	
	1.3, I.E.	02.90-10.94	65/66			F 026	005 080	19	
	1.4 I.E.	09.91-09.94	64			F 026	005 080	19	
	1.5 I.E., I.E. 4x4	06.90-10.94	71/74			F 026	005 080	19	
	1.7 I.E., I.E. 4x4, I.E. 16V, I.E. 16V 4x4	01.90-10.94	77/95-97			F 026	005 080	19	
	1.8 D Turbo	02.90-10.94	62			F 026	005 080	19	
	1.3, I.E.	02.90-10.94	65/66			F 026	005 078		
	1.4 I.E.	09.91-09.94	64			F 026	005 078		
	1.5 I.E.	06.90-10.94	74			F 026	005 078		
	1.7 I.E. 16V, I.E. 16V 4x4	01.90-10.94	95-97			F 026	005 078		
	1.3 I.E.	09.91-10.94	65			BSY	0 204 131 205		
	1.4 I.E.	09.91-09.94	64			BSY	0 204 131 205		
	1.5 I.E., I.E. 4x4	06.90-10.94	71/74			BSY	0 204 131 205		
	1.7 I.E., I.E. 4x4, I.E. 16V	01.90-10.94	77/95			BSY	0 204 131 205		
	1.7 I.E. 16V 4x4	ABO 01.90-10.94	95-97			BSY	0 204 131 205		
	1.3 I.E.	09.91-10.94	65				0 265 210 002^B		
	1.4 I.E.	09.91-09.94	64				0 265 210 002^B		
	1.5 I.E., I.E. 4x4	06.90-10.94	71/74				0 265 210 002^B		
	1.7 I.E., I.E. 4x4, I.E. 16V, I.E. 16V 4x4	01.90-10.94	77/95-97				0 265 210 002^B		
33 Sportwagon [907B]									
									
	1.3, 4x4	01.90-10.94	66			BSY	0 204 122 182	20,6	
	1.7 I.E. 4x4, I.E. 16V 4x4	06.90-10.94	77/95-97			BSY	0 204 122 182	20,6	
	1.8 TD	01.90-10.94	62			BSY	0 204 122 182	20,6	
	1.3, 4x4	01.90-10.94	66			F 026	005 080	19	
	1.7 I.E. 4x4, I.E. 16V 4x4	06.90-10.94	77/95-97			F 026	005 080	19	
	1.8 TD	01.90-10.94	62			F 026	005 080	19	



		S							
◀ ALFA ROMEO 33 Sportwagon [907B]									
	1.3, 4x4	01.90-10.94	66				F 026 005 078		
	1.7 I.E. 16V 4x4	06.90-10.94	95-97				F 026 005 078		
	1.7 I.E. 4x4	03.92-10.94	77			BSY	0 204 131 205		
	1.7 I.E. 16V 4x4	ABO 06.90-10.94	95-97			BSY	0 204 131 205		
	1.7 I.E. 4x4, I.E. 16V 4x4	06.90-10.94	77/95-97				0 265 210 002^B		
145 [930 MY95]									
									
	1.3 i.e.	04.94-11.96	68		JBH, LLE		F 026 003 528	22,2	
					RLE		0 204 122 268	22,22	
	1.6 i.e.	04.94-11.96	78		JBH, LLE		F 026 003 528	22,2	
					RLE		0 204 122 268	22,22	
	1.7 i.e. 16V	04.94-11.96	96		JBH, LLE		F 026 003 528	22,2	
					RLE		0 204 122 268	22,22	
	1.9 TD	04.94-11.96	66		JBH, LLE		F 026 003 528	22,2	
	2.0 i.e. 16VT.S.	10.95-11.96	110		RLE		0 204 122 268	22,22	
	1.9 TD	04.94-11.96	66		LLE		0 204 125 436		
							0 204 125 601^S		
	2.0 i.e. 16VT.S.	10.94-11.96	110				0 204 125 431^S		
		10.95-11.96	110		LLE		0 204 125 431^S		
					RLE		F 009 D01 098		
	1.3 i.e.	04.94-09.95	68		LLE		F 026 005 094	19	
					RLE		0 204 162 096		
		10.95-11.96	68		RLE		0 204 122 215		
	1.6 i.e.	04.94-09.95	78		LLE		F 026 005 094	19	
					RLE		0 204 162 096		
		10.95-11.96	78		RLE		0 204 122 215		
	1.7 i.e. 16V	04.94-09.95	96		LLE		F 026 005 094	19	
					RLE		0 204 162 096		
		10.95-11.96	96		RLE		0 204 122 215		
	1.9 TD	04.94-11.96	66		LLE		F 026 005 095	19	
	2.0 i.e. 16VT.S.	10.94-11.96	110		LLE		F 026 005 095	19	
		10.95-11.96	110		RLE		F 026 005 092	19	
	1.3 i.e.	04.94-11.96	68				0 204 163 078		
	1.6 i.e.	04.94-11.96	78				0 204 163 078		
	1.7 i.e. 16V	04.94-11.96	96				0 204 163 078		
	1.9 TD	04.94-11.96	66				F 026 005 581	25,4	
	2.0 i.e. 16VT.S.	10.94-11.96	110				F 026 005 581	25,4	
	1.3 i.e.	04.94-09.96	68				0 265 208 034^B		
		10.96-11.96	68				0 265 216 425^B		
	1.6 i.e.	04.94-09.96	78				0 265 208 034^B		
		10.96-11.96	78				0 265 216 425^B		
	1.7 i.e. 16V	04.94-09.96	96				0 265 208 034^B		
		10.96-11.96	96				0 265 216 425^B		
	1.9 TD	04.94-09.96	66				0 265 208 034^B		
		10.96-11.96	66				0 265 216 425^B		
	2.0 i.e. 16VT.S.	10.95-09.96	110				0 265 208 034^B		
		10.96-11.96	110				0 265 216 425^B		



















		S							
145 [930 MY97]									
									
	1.4 i.e. 16V T.S.	11.96-02.99	76			RLE	0 204 122 268	22,22	
	1.6 i.e. 16V T.S.	11.96-02.99	88			RLE	0 204 122 268	22,22	
	1.8 i.e. 16V T.S.	11.96-02.99	103			RLE	0 204 122 268	22,22	
	1.9 JTD	11.96-02.99	66/76			JBH,LLE	F 026 003 528	22,2	
	1.9 TD					RLE	0 204 122 268	22,22	
	2.0 i.e. 16V T.S.	11.96-02.99	110/114			RLE	0 204 122 268	22,22	
	1.4 i.e. 16V T.S.	11.96-02.99	76			RLE	F 009 D01 098		
	1.6 i.e. 16V T.S.	11.96-02.99	88			LLE	0 204 125 431^S		
						RLE	F 009 D01 098		
	1.8 i.e. 16V T.S.	11.96-02.99	103			LLE	0 204 125 431^S		
						RLE	F 009 D01 098		
	1.9 JTD	11.96-02.99	66/76			LLE	0 204 125 436		
	1.9 TD						0 204 125 601^S		
						RLE	F 009 D01 098		
	2.0 i.e. 16V T.S.	11.96-02.99	110/114			LLE	0 204 125 431^S		
						RLE	F 009 D01 098		
	1.4 i.e. 16V T.S.	11.96-02.99	76			LLE	F 026 005 095	19	
						RLE	F 026 005 092	19	
	1.6 i.e. 16V T.S.	11.96-02.99	88			LLE	F 026 005 095	19	
						RLE	F 026 005 092	19	
	1.8 i.e. 16V T.S.	11.96-04.98	103			RLE	F 026 005 092	19	
		11.96-02.99	103			LLE	F 026 005 095	19	
	1.9 JTD	05.98-02.99	76			LLE	F 026 005 095	19	
						RLE	F 026 005 092	19	
	2.0 i.e. 16V T.S.	11.96-04.98	110			RLE	F 026 005 092	19	
		11.96-02.99	110			LLE	F 026 005 095	19	
		05.98-02.99	114			LLE	F 026 005 095	19	
	1.4 i.e. 16V T.S.	11.96-02.99	76				F 026 005 581	25,4	
	1.6 i.e. 16V T.S.	11.96-02.99	88				F 026 005 581	25,4	
	1.8 i.e. 16V T.S.	11.96-02.99	103				F 026 005 581	25,4	
	1.9 JTD	05.98-02.99	76			LLE	F 026 005 580	25,4	
						RLE	F 026 005 581	25,4	
	2.0 i.e. 16V T.S.	11.96-02.99	110/114				F 026 005 581	25,4	
	1.4 i.e. 16V T.S.	11.96-02.99	76				0 265 216 425^B		
	1.6 i.e. 16V T.S.	11.96-02.99	88				0 265 216 425^B		
	1.8 i.e. 16V T.S.	11.96-02.99	103				0 265 216 425^B		
	1.9 JTD	05.98-02.99	76				0 265 216 687^B		
	1.9 TD	11.96-05.98	66				0 265 216 425^B		
	2.0 i.e. 16V T.S.	11.96-02.99	110				0 265 208 034^B		
		05.98-02.99	114				0 265 216 425^B		
145 [930 MY99]									
									
	1.4 i.e. 16V T.S.	02.99-12.00	76			RLE	0 204 123 523	22,22	
	1.6 i.e. 16V T.S.	02.99-12.00	82/88			RLE	0 204 123 523	22,22	
	1.8 i.e. 16V T.S.	02.99-12.00	103			RLE	0 204 123 523	22,22	
	1.9 JTD	02.99-12.00	76			JBH,LLE	F 026 003 528	22,2	
						RLE	0 204 123 523	22,22	
	2.0 i.e. 16V T.S.	02.99-12.00	110			RLE	0 204 123 523	22,22	
	1.6 i.e. 16V T.S.	02.99-12.00	82/88			LLE	0 204 125 431^S		
	1.8 i.e. 16V T.S.	02.99-12.00	103			LLE	0 204 125 431^S		
	1.9 JTD	02.99-07.99	76			LLE	0 204 125 436		
							0 204 125 601^S		













		S				?			
	◀ ALFA ROMEO 145 [930 MY99]								
	2.0 i.e. 16VT.S.	02.99-12.00	110		LLE		0 204 125 431 ^S		
	1.4 i.e. 16VT.S.	02.99-12.00	76		LLE		F 026 005 095	19	
					RLE		F 026 005 092	19	
	1.6 i.e. 16VT.S.	02.99-12.00	82/88		LLE		F 026 005 095	19	
					RLE		F 026 005 092	19	
	1.8 i.e. 16VT.S.	02.99-12.00	103		LLE		F 026 005 095	19	
					RLE		F 026 005 092	19	
	1.9 JTD	02.99-12.00	76		LLE		F 026 005 095	19	
					RLE		F 026 005 092	19	
	2.0 i.e. 16VT.S.	02.99-12.00	110		LLE		F 026 005 095	19	
					RLE		F 026 005 092	19	
	1.4 i.e. 16VT.S.	02.99-12.00	76				F 026 005 581	25,4	
	1.6 i.e. 16VT.S.	02.99-12.00	82/88				F 026 005 581	25,4	
	1.8 i.e. 16VT.S.	02.99-12.00	103				F 026 005 581	25,4	
	1.9 JTD	02.99-12.00	76		LLE		F 026 005 580	25,4	
					RLE		F 026 005 581	25,4	
	2.0 i.e. 16VT.S.	02.99-12.00	110				F 026 005 581	25,4	
	1.4 i.e. 16VT.S.	02.99-12.00	76				0 265 216 687 ^B		
	1.6 i.e. 16VT.S.	02.99-12.00	82/88				0 265 216 687 ^B		
	1.8 i.e. 16VT.S.	02.99-12.00	103				0 265 216 687 ^B		
	1.9 JTD	02.99-12.00	76				0 265 216 687 ^B		
	2.0 i.e. 16VT.S.	02.99-12.00	110				0 265 216 687 ^B		
146 [930 MY95]									
	1.9 TD	12.94-11.96	66		JBH,LLE		F 026 003 528	22,2	
	1.9 TD	12.94-11.96	66		LLE		0 204 125 436		
							0 204 125 601 ^S		
	2.0 ti 16VT.S.	10.95-11.96	110		LLE		0 204 125 431 ^S		
	1.3 i.e.	12.94-11.96	68		LLE		F 026 005 094	19	
					RLE		0 204 162 096		
	1.6 i.e.	05.95-11.96	76-78		LLE		F 026 005 094	19	
					RLE		0 204 162 096		
	1.7 i.e. 16V	12.94-11.96	96		LLE		F 026 005 094	19	
					RLE		0 204 162 096		
	1.9 TD	12.94-11.96	66		LLE		F 026 005 095	19	
	2.0 ti 16VT.S.	10.95-11.96	110		LLE		F 026 005 095	19	
					RLE		F 026 005 092	19	
	1.3 i.e.	12.94-11.96	68				0 204 163 078		
	1.6 i.e.	05.95-11.96	76-78				0 204 163 078		
	1.7 i.e. 16V	12.94-11.96	96				0 204 163 078		
	1.9 TD	12.94-11.96	66				F 026 005 581	25,4	
	2.0 ti 16VT.S.	10.95-11.96	110				F 026 005 581	25,4	
	1.3 i.e.	12.94-11.96	68				0 265 208 034 ^B		
	1.6 i.e.	05.95-11.96	76-78				0 265 208 034 ^B		
	1.7 i.e. 16V	12.94-11.96	96				0 265 208 034 ^B		
	1.9 TD	12.94-11.96	66				0 265 208 034 ^B		
	2.0 ti 16VT.S.	10.95-11.96	110				0 265 216 425 ^B		



		S							
146 [930 MY97]									
									
	1.4 i.e. 16V T.S.	11.96-02.99	76			JBH,LLE	F 026 003 528		22,2
						RLE	0 204 122 268		22,22
	1.6 i.e. 16V T.S.	11.96-02.99	88			RLE	0 204 122 268		22,22
	1.8 i.e. 16V T.S.	11.96-02.99	103			RLE	0 204 122 268		22,22
	1.9 JTD, TD	11.96-02.99	66/77			JBH,LLE	F 026 003 528		22,2
	2.0 ti 16V T.S.	11.96-02.99	110			RLE	0 204 122 268		22,22
	1.4 i.e. 16V T.S.	11.96-02.99	76			RLE	F 009 D01 098		
	1.6 i.e. 16V T.S.	11.96-02.99	88			LLE	0 204 125 431^S		
						RLE	F 009 D01 098		
	1.8 i.e. 16V T.S.	11.96-04.98	103			LLE	0 204 125 431^S		
		11.96-02.99	103			RLE	F 009 D01 098		
	1.9 JTD	11.96-02.99	66/77			LLE	0 204 125 436		
	1.9 TD						0 204 125 601^S		
	2.0 ti 16V T.S.	11.96-02.99	110			LLE	0 204 125 431^S		
						RLE	F 009 D01 098		
	1.4 i.e. 16V T.S.	11.96-02.99	76			LLE	F 026 005 095		19
	1.6 i.e. 16V T.S.	11.96-02.99	88			LLE	F 026 005 095		19
						RLE	F 026 005 092		19
	1.8 i.e. 16V T.S.	11.96-04.98	103			RLE	F 026 005 092		19
		11.96-02.99	103			LLE	F 026 005 095		19
	1.9 JTD	05.98-02.99	77			LLE	F 026 005 095		19
						RLE	F 026 005 092		19
	1.9 TD	11.96-05.98	66			LLE	F 026 005 095		19
	2.0 ti 16V T.S.	11.96-04.98	110			RLE	F 026 005 092		19
		11.96-02.99	110			LLE	F 026 005 095		19
	1.4 i.e. 16V T.S.	11.96-02.99	76				F 026 005 581		25,4
	1.6 i.e. 16V T.S.	11.96-02.99	88				F 026 005 581		25,4
	1.8 i.e. 16V T.S.	11.96-02.99	103				F 026 005 581		25,4
	1.9 JTD	05.98-02.99	77			LLE	F 026 005 580		25,4
						RLE	F 026 005 581		25,4
	1.9 TD	11.96-05.98	66				F 026 005 581		25,4
	2.0 ti 16V T.S.	11.96-02.99	110				F 026 005 581		25,4
	1.4 i.e. 16V T.S.	11.96-02.99	76				0 265 216 425^B		
	1.6 i.e. 16V T.S.	11.96-02.99	88				0 265 216 425^B		
	1.8 i.e. 16V T.S.	11.96-02.99	103				0 265 216 425^B		
	1.9 JTD	05.98-02.99	77				0 265 216 687^B		
	1.9 TD	11.96-05.98	66			Ricam.Nr →00173863	0 265 216 425^B		
						Ricam.Nr 00173864 →	0 265 216 687^B		
	2.0 ti 16V T.S.	11.96-02.99	110				0 265 216 425^B		
146 [930 MY99]									
									
	1.4 i.e. 16V T.S.	02.99-12.00	76			RLE	0 204 123 523		22,22
	1.6 i.e. 16V T.S.	02.99-12.00	82/88			RLE	0 204 123 523		22,22
	1.8 i.e. 16V T.S.	02.99-12.00	103			RLE	0 204 123 523		22,22
	1.9 JTD	02.99-12.00	77			JBH,LLE	F 026 003 528		22,2
						RLE	0 204 123 523		22,22
	2.0 ti 16V T.S.	02.99-12.00	110			RLE	0 204 123 523		22,22
	1.6 i.e. 16V T.S.	02.99-12.00	82/88			LLE	0 204 125 431^S		
	1.8 i.e. 16V T.S.	02.99-12.00	103			LLE	0 204 125 431^S		
	1.9 JTD	02.99-07.99	77			LLE	0 204 125 436		
							0 204 125 601^S		
	2.0 ti 16V T.S.	02.99-12.00	110			LLE	0 204 125 431^S		





















		S							
◀ ALFA ROMEO 146 [930 MY99]									
	1.4 i.e. 16VT.S.	02.99-12.00	76			LLE	F 026 005 095	19	
						RLE	F 026 005 092	19	
	1.6 i.e. 16VT.S.	02.99-12.00	82/88			LLE	F 026 005 095	19	
						RLE	F 026 005 092	19	
	1.8 i.e. 16VT.S.	02.99-12.00	103			LLE	F 026 005 095	19	
						RLE	F 026 005 092	19	
	1.9 JTD	02.99-12.00	77			LLE	F 026 005 095	19	
						RLE	F 026 005 092	19	
	2.0 ti 16VT.S.	02.99-12.00	110			LLE	F 026 005 095	19	
						RLE	F 026 005 092	19	
	1.4 i.e. 16VT.S.	02.99-12.00	76				F 026 005 581	25,4	
	1.6 i.e. 16VT.S.	02.99-12.00	82/88				F 026 005 581	25,4	
	1.8 i.e. 16VT.S.	02.99-12.00	103				F 026 005 581	25,4	
	1.9 JTD	02.99-12.00	77			LLE	F 026 005 580	25,4	
						RLE	F 026 005 581	25,4	
	2.0 ti 16VT.S.	02.99-12.00	110				F 026 005 581	25,4	
	1.4 i.e. 16VT.S.	02.99-12.00	76				0 265 216 687 ^B		
	1.6 i.e. 16VT.S.	02.99-12.00	82/88				0 265 216 687 ^B		
	1.8 i.e. 16VT.S.	02.99-12.00	103				0 265 216 687 ^B		
	1.9 JTD	02.99-12.00	77				0 265 216 687 ^B		
	2.0 ti 16VT.S.	02.99-12.00	110				0 265 216 687 ^B		
							0 265 216 687 ^B		
147 [937]									
	1.6 TS 16V	MFD	10.06-12.10	88			JBH,LLE	0 986 480 988	22,2
		OFD	11.00-06.02	88			JBH,LLE	0 986 480 865	22,2
	1.6 TS 16VECO	MFD	10.06-12.10	77			JBH,LLE	0 986 480 988	22,2
		OFD	11.00-06.02	77			JBH,LLE	0 986 480 865	22,2
			07.02-12.10	77			JBH,LLE	0 986 480 988	22,2
	1.9 JTD	OFD	11.00-06.02	81-85			JBH,LLE	0 986 480 865	22,2
			06.03-10.06	74			JBH,LLE	0 986 480 988	22,2
	1.9 JTDM		01.07-12.10	85			JBH,LLE	0 986 480 988	22,2
		MFD	10.06-12.10	85			JBH,LLE	0 986 480 988	22,2
		OFD	01.06-07.07	85			JBH,LLE	0 986 480 988	22,2
	1.9 JTDM, JTDM 16V	OFD	06.03-12.10	88/93			JBH,LLE	0 986 480 988	22,2
	1.9 JTDM 16V	OFD	01.07-12.10	100			JBH,LLE	0 986 480 988	22,2
				110			JBH,LLE	0 986 480 988	22,2
		MFD	10.06-12.10	100			JBH,LLE	0 986 480 988	22,2
			110			JBH,LLE	0 986 480 988	22,2	
			10.07-12.10	125			JBH,LLE	0 986 480 988	22,2
		OFD	10.02-09.03	103			JBH,LLE	0 986 480 988	22,2
			02.04-07.07	100			JBH,LLE	0 986 480 988	22,2
	2.0 TS 16V		10.04-02.06	110			JBH,LLE	0 986 480 988	22,2
		OFD	10.06-12.10	110			JBH,LLE	0 986 480 988	22,2
			11.00-06.02	110			JBH,LLE	0 986 480 865	22,2
			07.02-09.03	110			JBH,LLE	0 986 480 988	22,2
		1.6 TS 16V, TS 16VECO	11.00-09.06	77/88			LLE	0 986 486 084	15,87
		1.9 JTD, JTDM, JTDM 16V	11.00-09.06	74/81-85/88/93/100/103/110			LLE	0 986 486 084	15,87
		2.0 TS 16V	11.00-09.06	110			LLE	0 986 486 084	15,87
		3.2 GTA	01.03-09.06	184			LLE	0 986 486 084	15,87
			1.9 JTD	11.00-03.05	81-85			RLE	0 986 486 573
							LLE	0 986 486 573	20,6
					Fg.-Nr. 3078410→, 5037879→				
			06.03-10.06	74				0 986 486 556	20,6
1.9 JTDM, JTDM 16V	10.02-12.10		85/88/93/100/103/110				0 986 486 573	20,6	
3.2 GTA	01.03-12.10	184			GS	0 986 486 573	20,6		

		S							
 1.6 TS 16V	11.00-10.02	88	Ricam.Nr →03222100				0 265 225 143 ^T		
	11.00-12.05	88	Ricam.Nr →3486880				0 265 222 041 ^B		
	11.00-01.06	88	Ricam.Nr →3486880				0 265 224 102 ^F		
	11.02-09.04	88	Ricam.Nr 03222101→033596580				0 265 225 143 ^T		
	10.04-12.05	88	Ricam.Nr 03396581→03486880				0 265 225 398 ^T		
	01.06-09.06	88	Ricam.Nr 03486881→				0 265 234 259 ^T		
	01.06-12.10	88	Ricam.Nr 3486881→				0 265 231 633 ^B		
	02.06-12.10	88	Ricam.Nr 03486881→				0 265 233 336 ^F		
	10.06-12.10	88					0 265 235 358 ^T		
	1.6 TS 16V ECO	11.00-12.05	77	Ricam.Nr →3486880				0 265 222 041 ^B	
11.00-01.06		77	Ricam.Nr →3486880				0 265 224 102 ^F		
10.04-12.05		77	Ricam.Nr 03396581→03486880				0 265 225 398 ^T		
01.06-09.06		77	Ricam.Nr 03486881→				0 265 234 259 ^T		
01.06-12.10		77	Ricam.Nr 3486881→				0 265 231 633 ^B		
02.06-12.10		77	Ricam.Nr 03486881→				0 265 233 336 ^F		
10.06-12.10		77					0 265 235 358 ^T		
1.9 JTD	11.00-10.02	81-85	Ricam.Nr →03222100				0 265 225 143 ^T		
	11.00-03.05	81-85					0 265 222 041 ^B		
							0 265 224 102 ^F		
	11.02-09.04	81-85	Ricam.Nr 03222101→033596580				0 265 225 143 ^T		
	06.03-10.06	74					0 265 222 041 ^B		
	10.04-03.05	81-85	Ricam.Nr 3396581→				0 265 225 398 ^T		
1.9 JTDM	04.05-01.06	88	Ricam.Nr →3489987				0 265 222 041 ^B		
							0 265 224 102 ^F		
							0 265 225 398 ^T		
	01.06-09.06	85					0 265 234 259 ^T		
	01.06-12.10	85					0 265 231 633 ^B		
							0 265 233 336 ^F		
	02.06-09.06	88	Ricam.Nr 3489988→				0 265 234 259 ^T		
	02.06-12.10	88	Ricam.Nr 3489988→				0 265 231 633 ^B		
							0 265 233 336 ^F		
	10.06-12.10	85					0 265 235 358 ^T		
1.9 JTDM 16V	10.02-09.03	103					0 265 224 102 ^F		
			Ricam.Nr →33596580				0 265 225 143 ^T		
	06.03-09.04	93	Ricam.Nr →33596580				0 265 225 143 ^T		
	06.03-09.06	93					0 265 224 102 ^F		
	02.04-12.05	100					0 265 224 102 ^F		
							0 265 225 398 ^T		
	10.04-12.05	110					0 265 224 102 ^F		
							0 265 225 398 ^T		
	10.04-09.06	93	Ricam.Nr 3396581→				0 265 225 398 ^T		
	01.06-09.06	100					0 265 234 259 ^T		
	01.06-12.10	100					0 265 233 336 ^F		
	03.06-09.06	110					0 265 234 259 ^T		
	03.06-12.10	110					0 265 233 336 ^F		
	10.06-12.10	100					0 265 235 358 ^T		
10.07-12.10	125					0 265 233 336 ^F			
						0 265 235 358 ^T			
2.0 TS 16V	11.00-10.02	110	Ricam.Nr →03222100				0 265 225 143 ^T		
	11.02-09.04	110	Ricam.Nr 03222101→033596580				0 265 225 143 ^T		
	10.04-12.05	110	Ricam.Nr 03396581→03486880				0 265 225 398 ^T		
	01.06-09.06	110	Ricam.Nr 03486881→				0 265 234 259 ^T		
	10.06-12.10	110					0 265 231 633 ^B		
							0 265 233 336 ^F		
3.2 GTA	01.03-09.04	184	Ricam.Nr →33596580				0 265 225 143 ^T		
	10.04-12.10	184	Ricam.Nr 3396581→				0 265 225 398 ^T		
	1.6 TS 16V, TS 16V ECO	11.00-12.10	77/88				0 265 005 241		
	1.9 JTD, JTDM, JTDM 16V	11.00-12.10	74/81-85/88/93/100/103/110/125				0 265 005 241		
	2.0 TS 16V	11.00-12.10	110				0 265 005 241		



















ALFA ROMEO 147 [937]								
	3.2 GTA	01.03-12.10	184			0 265	005 241	
	1.9 JTDM 16V	01.06-02.06	100	Ricam.Nr →3489988		0 265	005 303	
	2.0 TS 16V	11.00-01.06	110	Ricam.Nr →3486654		0 265	005 303	
	3.2 GTA	01.03-01.06	184	Ricam.Nr →3486654		0 265	005 303	
155 [167 MY92]								
	1.7 T.S.	04.93-04.96	85	Fg.-Nr. →0069451	LLE	0 204	125 405^S	
					RLE	0 204	125 439^S	
				Fg.-Nr. 0069452→	LLE	0 204	125 431^S	
	1.8 T.S.	02.92-04.96	77/93-95	Fg.-Nr. →0069451	LLE	0 204	125 405^S	
					RLE	0 204	125 439^S	
				Fg.-Nr. 0069452→	LLE	0 204	125 431^S	
	1.9 TD	04.93-04.96	66		LLE	0 204	125 601^S	
	2.0 T.S.	04.93-04.96	104/110	Fg.-Nr. →0069451	LLE	0 204	125 405^S	
	2.0 T.S. 16V				RLE	0 204	125 439^S	
				Fg.-Nr. 0069452→	LLE	0 204	125 431^S	
	2.0 Turbo 4x4	02.92-04.96	140			0 204	125 431^S	
	2.5 TD	04.93-04.96	92			0 204	125 431^S	
	2.5 V6	02.92-04.96	120		LLE	0 204	125 431^S	
	1.7 T.S.	04.93-04.96	85		LLE	F 026	005 091	19
					RLE	F 026	005 092	19
	1.8 T.S.	02.92-04.96	77		RLE	F 026	005 092	19
				Ricam.Nr →0129253	LLE	F 026	005 091	19
				Ricam.Nr 0129254→	LLE	F 026	005 095	19
			93-95		LLE	F 026	005 091	19
					RLE	F 026	005 092	19
	1.9 TD	04.93-04.96	66		LLE	F 026	005 091	19
	2.0 T.S.	04.93-04.96	104/110		LLE	F 026	005 091	19
	2.0 T.S. 16V				RLE	F 026	005 092	19
	2.0 Turbo 4x4	02.92-04.96	140		LLE	F 026	005 091	19
	2.5 TD	04.93-04.96	92			F 026	005 095	19
	2.5 V6	02.92-04.96	120		LLE	F 026	005 091	19
					RLE	F 026	005 092	19
	1.7 T.S.	04.93-04.96	85			F 026	005 581	25,4
				Fg.-Nr. →0075933		0 204	163 074	
	1.8 T.S.	02.92-06.95	77	Fg.-Nr. 0075934→		F 026	005 581	25,4
		02.92-04.96	77	Fg.-Nr. →0075933		0 204	163 074	
			93-95			F 026	005 581	25,4
				Fg.-Nr. →0075933		0 204	163 074	
		07.95-04.96	77			F 026	005 581	25,4
	1.9 TD	04.93-04.96	66			F 026	005 581	25,4
	2.0 T.S.	04.93-02.95	104	Fg.-Nr. →0075933		0 204	163 074	
				Fg.-Nr. 0075934→		F 026	005 581	25,4
	2.0 T.S. 16V	03.95-04.96	110			F 026	005 581	25,4
				Fg.-Nr. →0075933		0 204	163 074	
	2.5 TD	06.95-04.96	92			0 204	163 077	
	2.5 V6	02.92-04.96	120			F 026	005 580	25,4
	1.8 T.S.	02.92-04.96	77			0 204	131 221	
	1.7 T.S.	04.93-04.96	85	Ricam.Nr 69451→		0 265	208 034^B	
	1.8 T.S.	02.92-04.96	77/93-95	Ricam.Nr 69451→		0 265	208 034^B	
	1.9 TD	04.93-04.96	66			0 265	208 034^B	
	2.0 T.S.	04.93-02.95	104	Ricam.Nr 69451→		0 265	208 034^B	
	2.0 T.S. 16V	03.95-04.96	110			0 265	208 034^B	
	2.0 Turbo 4x4	02.92-04.96	140			0 265	201 054^H	

		S							
		2.5 TD	04.93-04.96	92			0 265 208 034 ^B		
		2.5 V6	02.92-04.96	120	Ricam.Nr 0027224→		0 265 208 034 ^B		
		2.0 Turbo 4x4	02.92-04.96	140			0 265 005 030		
							0 265 005 031 ⁵		
155 [167 MY96]									
									
		1.6 i16VT.S.	05.96-10.97	85		RLE	0 204 122 268	22,22	
		1.8 i16VT.S.	05.96-10.97	100		RLE	0 204 122 268	22,22	
		2.0 i16VT.S.	05.96-10.97	110		RLE	0 204 122 268	22,22	
		2.5 iV6	10.92-10.97	120		RLE	0 204 122 268	22,22	
		1.6 i16VT.S.	05.96-10.97	85		LLE	0 204 125 431 ^S		
		1.8 i16VT.S.	05.96-10.97	100		LLE	0 204 125 431 ^S		
		1.9 TD	05.96-10.97	66		LLE	0 204 125 601 ^S		
		2.0 i16VT.S.	05.96-10.97	110		LLE	0 204 125 431 ^S		
		2.5 iV6	10.92-10.97	120		LLE	0 204 125 431 ^S		
		2.5 TD	05.96-10.97	92			0 204 125 431 ^S		
		1.6 i16VT.S.	05.96-10.97	85		LLE	F 026 005 095	19	
		1.8 i16VT.S.	05.96-10.97	100		LLE	F 026 005 095	19	
						RLE	F 026 005 092	19	
		1.9 TD	05.96-10.97	66		LLE	F 026 005 095	19	
		2.0 i16VT.S.	05.96-10.97	110		LLE	F 026 005 095	19	
						RLE	F 026 005 092	19	
		2.5 iV6	10.92-10.97	120		LLE	F 026 005 091	19	
						RLE	F 026 005 092	19	
		2.5 TD	05.96-10.97	92		LLE	F 026 005 095	19	
		1.6 i16VT.S.	05.96-10.97	85			F 026 005 581	25,4	
		1.8 i16VT.S.	05.96-10.97	100			F 026 005 581	25,4	
		1.9 TD	05.96-10.97	66			F 026 005 581	25,4	
		2.0 i16VT.S.	05.96-10.97	110			F 026 005 581	25,4	
		2.5 iV6	10.92-10.97	120			F 026 005 580	25,4	
		2.5 TD	05.96-10.97	92			0 204 163 077		
		1.6 i16VT.S.	05.96-10.97	85			0 204 131 221		
		1.8 i16VT.S.	05.96-10.97	100			0 204 131 221		
		2.0 i16VT.S.	05.96-10.97	110			0 204 131 221		
		1.6 i16VT.S.	05.96-10.97	85	Ricam.Nr →00180828		0 265 208 034 ^B		
					Ricam.Nr 00180829→		0 265 216 425 ^B		
		1.8 i16VT.S.	05.96-10.97	100	Ricam.Nr →00180828		0 265 208 034 ^B		
					Ricam.Nr 00180829→		0 265 216 425 ^B		
		1.9 TD	05.96-10.97	66	Ricam.Nr →00180828		0 265 208 034 ^B		
					Ricam.Nr 00180829→		0 265 216 425 ^B		
		2.0 i16VT.S.	05.96-10.97	110	Ricam.Nr →00180828		0 265 208 034 ^B		
					Ricam.Nr 00180829→		0 265 216 425 ^B		
		2.5 iV6	10.92-10.97	92/120	Ricam.Nr →00180828		0 265 208 034 ^B		
		2.5 TD			Ricam.Nr 00180829→		0 265 216 425 ^B		
156 Berlina [932]									
									
		1.6 TS 16V	09.00-12.01	88		RLE	0 204 123 676	22,2	
			01.02-10.05	88		LLE	0 204 123 621	20,6	
						RLE	0 204 123 623	22,2	
		1.8 TS 16V	10.97-09.00	106		RLE	0 204 123 676	22,2	
			09.00-12.01	103		RLE	0 204 123 676	22,2	



		S									
	◀ ALFA ROMEO 156 Berlina [932]										
1.8 TS 16V	01.02-10.05	103				LLE	0 204 123 621	20,6			
						RLE	0 204 123 623	22,2			
1.9 JTD	01.02-10.05	74/85				LLE	0 204 123 621	20,6			
						RLE	0 204 123 623	22,2			
1.9 JTD 16V	10.02-10.05	100/103				JBH,LLE	F 026 003 622	22,2			
						RLE	0 204 123 623	22,2			
2.0 JTS 16V	01.02-12.05	119/121				JBH,LLE	F 026 003 622	22,2			
						RLE	0 204 123 623	22,2			
2.0 TS 16V	10.97-09.00	114				RLE	0 204 123 676	22,2			
2.0 TS 16V	09.00-12.01	110				RLE	0 204 123 676	22,2			
2.0 TS 16V	01.02-10.05	110				JBH,LLE	F 026 003 622	22,2			
						RLE	0 204 123 623	22,2			
2.4 JTD	01.02-10.05	110				JBH,LLE	F 026 003 622	22,2			
						RLE	0 204 123 621	20,6			
2.4 JTD	06.03-10.05	120/129				JBH,LLE	F 026 003 622	22,2			
2.4 JTD 20V						RLE	0 204 123 623	22,2			
2.5 24V	10.97-09.00	140	Ricam.Nr →0182141	Ricam.Nr →133065		AG,RLE	0 204 123 676	22,2			
						GS,RLE	0 204 123 676	22,2			
2.5 24V	01.02-10.05	141				AG,LLE	0 204 123 621	20,6			
						GS,JBH,LLE	F 026 003 622	22,2			
						RLE	0 204 123 621	20,6			
	1.6 TS 16V	09.00-12.01	88			RLE	F 009 D01 188				
	1.8 TS 16V	10.97-12.01	103/106			RLE	F 009 D01 188				
	2.0 TS 16V	10.97-12.01	110/114			RLE	F 009 D01 188				
	2.5 24V	10.97-09.00	140	Ricam.Nr →0182141	Ricam.Nr →133065	AG,RLE	F 009 D01 188				
						GS,RLE	F 009 D01 188				
	3.2 GTA	03.02-10.05	184				0 204 125 803				
	1.6 TS 16V	10.97-10.05	82/88			LLE	0 986 486 104	15,87			
	1.8 TS 16V	10.97-10.05	103/106			LLE	0 986 486 104	15,87			
	1.9 JTD	10.97-12.01	76/81-85				F 026 005 119	19			
						01.02-10.05	85	LLE	F 026 005 119	19	
								RLE	F 026 005 092	19	
	1.9 JTD 16V	10.02-10.05	100/103				F 026 005 119	19			
						06.03-12.04	74		F 026 005 119	19	
	2.0 JTS 16V, TS 16V	10.97-12.05	110/114/119/121			LLE	0 986 486 104	15,87			
	2.4 JTD	10.97-12.01	100				F 026 005 119	19			
						06.03-10.05	129	LLE	0 986 486 104	15,87	
	2.4 JTD	01.02-10.05	110/120			LLE	F 026 005 119	19			
	2.4 JTD 20V					RLE	F 026 005 092	19			
	2.5 24V	10.97-10.05	140/141			LLE	F 026 005 119	19			
								RLE	F 026 005 092	19	
	3.2 GTA	03.02-10.05	184			LLE	F 026 005 119	19			
								RLE	F 026 005 092	19	
	1.6 TS 16V	01.02-10.05	88				F 026 005 580	25,4			
	1.8 TS 16V	01.02-10.05	103				F 026 005 580	25,4			
	1.9 JTD, JTD 16V	10.97-12.05	74/76/81-85/93/100/103/110				F 026 005 580	25,4			
	2.0 JTS 16V, TS 16V	01.02-12.05	110/119/121				F 026 005 580	25,4			
	2.4 JTD, JTD 20V	10.97-10.05	100/110/120/129				F 026 005 580	25,4			
	2.5 24V	10.97-10.05	140/141				F 026 005 580	25,4			
	3.2 GTA	03.02-10.05	184			GS	F 026 005 580	25,4			
	1.6 TS 16V	10.97-09.00	88				0 265 216 402 ^C				
		04.98-09.00	82				0 265 216 402 ^C				
		09.00-10.05	88				0 265 216 802 ^B				
		01.02-10.05	88				0 265 225 281 ^T				

		S							
1.8 TS 16V		10.97-09.00	106				0 265 216 402 ^C		
		09.00-10.05	103				0 265 216 802 ^B		
		01.02-10.05	103				0 265 225 281 ^T		
1.9 JTD		10.97-12.01	76/81-85				0 265 216 402 ^C		
		01.02-10.05	85				0 265 216 802 ^B		
		06.03-12.04	74				0 265 225 281 ^T		
1.9 JTD 16V		10.02-12.05	100/103/ 110				0 265 216 802 ^B		
		06.03-10.05	93				0 265 225 281 ^T		
		01.02-12.05	119/121				0 265 216 802 ^B		
2.0 TS 16V		10.97-12.01	114				0 265 216 402 ^C		
		09.00-10.05	110				0 265 216 802 ^B		
		01.02-10.05	110				0 265 225 281 ^T		
2.4 JTD		10.97-12.01	100			0 265 216 402 ^C			
2.4 JTD		01.02-10.05	110/120/			0 265 216 802 ^B			
2.4 JTD 20V			129			0 265 225 281 ^T			
2.5 24V		10.97-12.01	140				0 265 216 402 ^C		
		09.00-12.01	140				0 265 216 802 ^B		
		01.02-10.05	141				0 265 216 802 ^B		
3.2 GTA		03.02-10.05	184				0 265 225 281 ^T		
		03.02-10.05	184				0 265 225 281 ^T		
		03.02-10.05	184				0 265 225 281 ^T		
	1.6 TS 16V	10.97-09.00	82/88				1 273 004 483 ^H		
	1.8 TS 16V	10.97-09.00	106				1 273 004 483 ^H		
	1.9 JTD	10.97-12.01	76/81-85				1 273 004 483 ^H		
	2.0 TS 16V	10.97-12.01	114				1 273 004 483 ^H		
	2.4 JTD	10.97-12.01	100				1 273 004 483 ^H		
	2.5 24V	10.97-12.01	140				1 273 004 483 ^H		
	1.6 TS 16V	01.02-10.05	88				0 265 005 241		
	1.8 TS 16V	01.02-10.05	103				0 265 005 241		
	1.9 JTD, JTD 16V	01.02-12.05	74/85/93/100/103/110				0 265 005 241		
	2.0 JTS 16V, TS 16V	01.02-12.05	110/119/121				0 265 005 241		
	2.4 JTD, JTD 20V	01.02-10.05	110/120/129				0 265 005 241		
	2.5 24V	01.02-10.05	141				0 265 005 241		
	3.2 GTA	03.02-10.05	184				0 265 005 241		
	1.6 TS 16V	01.02-10.05	88				0 265 005 303		
	1.8 TS 16V	01.02-10.05	103				0 265 005 303		
	1.9 JTD, JTD 16V	01.02-12.05	74/85/93/100/103/110				0 265 005 303		
	2.0 JTS 16V, TS 16V	01.02-12.05	110/119/121				0 265 005 303		
	2.4 JTD, JTD 20V	01.02-10.05	110/120/129				0 265 005 303		
	2.5 24V	01.02-10.05	141				0 265 005 303		
	3.2 GTA	03.02-10.05	184				0 265 005 303		
156 Sport Wagon Q4 [932]									
									
	1.9 JTD 16V 4x4	10.04-12.05	110			LLE	F 026 005 119	19	
						RLE	F 026 005 092	19	
	1.9 JTD 16V 4x4	10.04-12.05	110				F 026 005 580	25,4	
	1.9 JTD 16V 4x4	10.04-12.05	110				0 265 225 264 ^B		
	1.9 JTD 16V 4x4	10.04-12.05	110				0 265 005 241		





◀ ALFA ROMEO 156 Sport Wagon Q4 [932]

	1.9 JTD 16V 4x4	10.04-12.05	110			0 265 005 303	
--	-----------------	-------------	-----	--	--	---------------	--



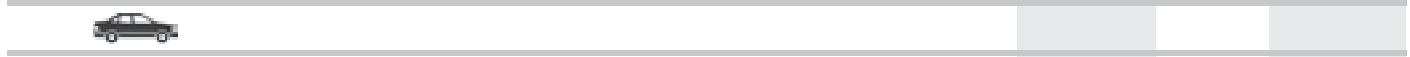









156 Sport Wagon [932]



	1.6 TS 16V	09.00-12.01	88		RLE	0 204 123 676	22,2
		01.02-12.05	88		LLE	0 204 123 621	20,6
					RLE	0 204 123 623	22,2
	1.8 TS 16V	06.00-12.01	106		RLE	0 204 123 676	22,2
		01.02-12.05	106		LLE	0 204 123 621	20,6
					RLE	0 204 123 623	22,2
	1.9 JTD	01.02-12.05	74/85		LLE	0 204 123 621	20,6
					RLE	0 204 123 623	22,2
	1.9 JTD 16V	10.02-12.05	100/103		JBH,LLE	F 026 003 622	22,2
					RLE	0 204 123 623	22,2
		06.03-10.05	93		JBH	F 026 003 622	22,2
		10.03-12.05	93		JBH,LLE	F 026 003 622	22,2
			110		JBH,LLE	F 026 003 622	22,2
	2.0 JTS 16V	01.02-12.05	121		JBH,LLE	F 026 003 622	22,2
					RLE	0 204 123 623	22,2
	2.0 TS 16V	06.00-09.00	114		RLE	0 204 123 676	22,2
		09.00-12.01	110		RLE	0 204 123 676	22,2
		01.02-10.05	110		JBH,LLE	F 026 003 622	22,2
					RLE	0 204 123 623	22,2
	2.4 JTD	01.02-10.05	110		JBH,LLE	F 026 003 622	22,2
					RLE	0 204 123 621	20,6
	2.4 JTD	06.03-12.05	120/129		JBH,LLE	F 026 003 622	22,2
					RLE	0 204 123 623	22,2
	2.4 JTD 20V				RLE	0 204 123 623	22,2
					RLE	0 204 123 623	22,2
	2.5 24V	06.00-09.00	140	Ricam.Nr →133065	RLE	0 204 123 676	22,2
		01.02-10.05	141		AG,LLE	0 204 123 621	20,6
					GS,JBH,LLE	F 026 003 622	22,2
					RLE	0 204 123 621	20,6

	1.6 TS 16V	09.00-12.01	88		RLE	F 009 D01 188	
	1.8 TS 16V	06.00-12.01	106		RLE	F 009 D01 188	
	2.0 TS 16V	06.00-12.01	110/114		RLE	F 009 D01 188	
	2.5 24V	06.00-09.00	140	Ricam.Nr →133065	RLE	F 009 D01 188	



















	1.6 TS 16V	06.00-12.05	88		LLE	0 986 486 104	15,87
		06.00-12.05	106		LLE	0 986 486 104	15,87
	1.9 JTD	06.00-12.01	76/80-85			F 026 005 119	19
		01.02-12.05	85		LLE	F 026 005 119	19
					RLE	F 026 005 092	19
		06.03-12.04	74			F 026 005 119	19
	1.9 JTD 16V	10.02-12.05	100/103/		LLE	F 026 005 119	19
			110		RLE	F 026 005 092	19
		06.03-10.05	93			F 026 005 119	19
		10.03-12.05	93		LLE	F 026 005 119	19
					RLE	F 026 005 092	19
	2.0 JTS 16V, TS 16V	06.00-12.05	110/114/121		LLE	0 986 486 104	15,87
	2.4 JTD	06.00-12.01	100			F 026 005 119	19
		06.03-12.05	129		LLE	0 986 486 104	15,87
	2.4 JTD	01.02-10.05	110/120		LLE	F 026 005 119	19
	2.4 JTD 20V				RLE	F 026 005 092	19
	2.5 24V	06.00-10.05	140/141		LLE	F 026 005 119	19
					RLE	F 026 005 092	19
	3.2 GTA	03.02-10.05	184		LLE	F 026 005 119	19
					RLE	F 026 005 092	19

		S							
	1.6 TS 16V	01.02-12.05	88				F 026 005 580	25,4	
	1.8 TS 16V	01.02-12.05	106				F 026 005 580	25,4	
	1.9 JTD, JTD 16V	06.00-12.05	74/76/80-85/93/100/103/110				F 026 005 580	25,4	
	2.0 JTS 16V, TS 16V	01.02-12.05	110/121				F 026 005 580	25,4	
	2.4 JTD, JTD 20V	06.00-12.05	100/110/120/129				F 026 005 580	25,4	
	2.5 24V	06.00-10.05	140/141				F 026 005 580	25,4	
	3.2 GTA	03.02-10.05	184		GS		F 026 005 580	25,4	
	1.6 TS 16V	06.00-09.00	88				0 265 216 402^C		
		09.00-12.05	88				0 265 216 802^B		
		01.02-12.05	88				0 265 225 281^T		
	1.8 TS 16V	06.00-09.00	106				0 265 216 402^C		
		09.00-12.05	106				0 265 216 802^B		
		01.02-12.05	106				0 265 225 281^T		
	1.9 JTD	06.00-12.01	76/80-85				0 265 216 402^C		
		01.02-12.05	85				0 265 216 802^B		
		06.03-12.04	74				0 265 225 281^T		
							0 265 216 802^B		
							0 265 225 281^T		
	1.9 JTD 16V	10.02-12.05	100/103				0 265 216 802^B		
		06.03-10.05	93				0 265 225 281^T		
							0 265 216 802^B		
							0 265 225 281^T		
		10.03-12.05	93				0 265 225 264^B		
			110				0 265 225 264^B		
	2.0 JTS 16V	01.02-12.05	121				0 265 216 802^B		
							0 265 225 281^T		
	2.0 TS 16V	06.00-09.00	114				0 265 216 402^C		
		09.00-10.05	110				0 265 216 802^B		
		01.02-10.05	110				0 265 225 281^T		
	2.4 JTD	06.00-12.01	100				0 265 216 402^C		
	2.4 JTD, JTD 20V	01.02-12.05	110/120/129				0 265 216 802^B		
							0 265 225 281^T		
	2.5 24V	06.00-09.00	140				0 265 216 402^C		
		09.00-12.01	140				0 265 216 802^B		
		01.02-10.05	141				0 265 216 802^B		
							0 265 225 281^T		
	3.2 GTA	03.02-10.05	184				0 265 225 281^T		
	1.9 JTD	06.00-09.00	76				1 273 004 483^J		
		09.00-12.01	80-85				1 273 004 483^H		
	2.4 JTD	06.00-09.00	100				1 273 004 483^J		
		09.00-12.01	100				1 273 004 483^H		
	1.6 TS 16V	01.02-12.05	88				0 265 005 241		
	1.8 TS 16V	01.02-12.05	106				0 265 005 241		
	1.9 JTD, JTD 16V	01.02-12.05	74/85/93/100/103/110				0 265 005 241		
	2.0 JTS 16V, TS 16V	01.02-12.05	110/121				0 265 005 241		
	2.4 JTD, JTD 20V	01.02-12.05	110/120/129				0 265 005 241		
	2.5 24V	01.02-10.05	141				0 265 005 241		
	3.2 GTA	03.02-10.05	184				0 265 005 241		
	1.6 TS 16V	01.02-12.05	88				0 265 005 303		
	1.8 TS 16V	01.02-12.05	106				0 265 005 303		
	1.9 JTD, JTD 16V	01.02-12.05	74/85/93/100/103/110				0 265 005 303		
	2.0 JTS 16V, TS 16V	01.02-12.05	110/121				0 265 005 303		
	2.4 JTD, JTD 20V	01.02-12.05	110/120/129				0 265 005 303		
	2.5 24V	01.02-10.05	141				0 265 005 303		
	3.2 GTA	03.02-10.05	184				0 265 005 303		













		S							
◀ ALFA ROMEO									
156 Sportwagon [932]									
	2.0 JTS 16V	01.02-12.05	119			JBH, LLE RLE	F 026 003 622 0204 123 623	22,2	22,2
	2.0 JTS 16V	01.02-12.05	119			LLE	0986 486 104	15,87	
	2.0 JTS 16V	01.02-12.05	119				F 026 005 580	25,4	
	2.0 JTS 16V	01.02-12.05	119				0265 216 802^B 0265 225 281^T		
	2.0 JTS 16V	01.02-12.05	119				0265 005 241		
	2.0 JTS 16V	01.02-12.05	119				0265 005 303		
159 Berlina Q4 [939]									
	2.4 JTD 20V	10.06-12.08	154			JBH, LLE	0986 480 858	25,4	
	3.2 JTS	MFD 01.06-09.06	191-195	Ricam.Nr →7066346		JBH, LLE	0986 480 993	25,4	
		10.06-12.08	191-195	Ricam.Nr 7066347→		JBH, LLE	0986 480 858	25,4	
		OFD 01.06-09.06	191-195	Ricam.Nr →7066346		JBH, LLE	0986 480 858	25,4	
	2.4 JTD 20V	09.06-12.08	154				0986 486 579	34	
	3.2 JTS	01.06-12.08	191-195				0986 486 579	34	
159 Berlina [939]									
	1.8 i	MFD 03.06-11.11	103			JBH, LLE	0986 480 993	25,4	
		10.07-11.11	103	Ricam.Nr 7066347→		JBH, LLE	0986 480 858	25,4	
		OFD 03.06-11.11	103			JBH, LLE	0986 480 858	25,4	
	1.8 TBi	05.09-11.11	147			JBH, LLE	0986 480 858	25,4	
	1.9 JTDM 8V	MFD 06.05-12.08	88			JBH, LLE	0986 480 993	25,4	
		01.06-12.08	85			JBH, LLE	0986 480 993	25,4	
		10.07-12.08	88	Ricam.Nr 7066347→		JBH, LLE	0986 480 858	25,4	
	1.9 JTDM 8V, JTDM 16V, JTS	OFD 06.05-12.08	85/88/100/110/118			JBH, LLE	0986 480 858	25,4	
	1.9 JTDM 16V	MFD 01.06-12.08	100			JBH, LLE	0986 480 993	25,4	
	1.9 JTDM 16V	MFD 06.05-12.08	110/118			JBH, LLE	0986 480 993	25,4	
	1.9 JTS	10.07-12.08	110/118	Ricam.Nr →7066347→		JBH, LLE	0986 480 858	25,4	
	2.0 JTDM	05.09-12.11	120			JBH, LLE	0986 480 858	25,4	
	2.2 JTS	MFD 06.05-12.08	136			JBH, LLE	0986 480 993	25,4	
		10.07-12.08	136	Ricam.Nr 7066347→		JBH, LLE	0986 480 858	25,4	
		OFD 06.05-12.08	136			JBH, LLE	0986 480 858	25,4	
	2.4 JTD 20V	02.07-12.08	154			JBH, LLE	0986 480 858	25,4	
		MFD 10.07-12.08	154	Ricam.Nr 7066347→		JBH, LLE	0986 480 858	25,4	
	2.4 JTDM 20V	MFD 06.05-09.06	147	Ricam.Nr →7066346		JBH, LLE	0986 480 993	25,4	
		10.06-12.08	147	Ricam.Nr 7066347→		JBH, LLE	0986 480 858	25,4	
		OFD 06.05-09.06	147	Ricam.Nr →7066346		JBH, LLE	0986 480 858	25,4	
	3.2 JTS	MFD 08.07-12.08	195	Ricam.Nr 7066347→		JBH, LLE	0986 480 858	25,4	
	1.8 i	03.06-11.11	103				0986 486 588	31	
	1.9 JTDM 8V, JTDM 16V	06.05-12.08	85/88/100/110				0986 486 592	34	
	1.9 JTS	06.05-12.08	118				0986 486 591	34	



		S							
2.0 JTDM			05.09-12.11	120			0 986 486 579	34	
2.2 JTS			06.05-12.08	136			0 986 486 591	34	
2.4 JTD 20V, JTDM 20V			06.05-12.08	147/154			0 986 486 579	34	
3.2 JTS			08.07-12.08	195			0 986 486 579	34	
159 Sport Wagon Q4 [939]									
									
	2.4 JTD 20V		10.06-12.08	154		JBH, LLE	0 986 480 858	25,4	
	3.2 JTS	MFD	03.06-09.06	191-195	Ricam.Nr →7066346	JBH, LLE	0 986 480 993	25,4	
			10.06-12.08	191-195	Ricam.Nr 7066347→	JBH, LLE	0 986 480 858	25,4	
		OFD	03.06-09.06	191-195	Ricam.Nr →7066346	JBH, LLE	0 986 480 858	25,4	
	2.4 JTD 20V		09.06-12.08	154			0 986 486 579	34	
	3.2 JTS		03.06-12.08	191-195			0 986 486 579	34	
159 Sport Wagon [939]									
									
	1.8 Tbi		05.09-12.10	147		JBH, LLE	0 986 480 858	25,4	
	1.9 JTDM 8V	MFD	03.06-12.08	85		JBH, LLE	0 986 480 993	25,4	
				88		JBH, LLE	0 986 480 993	25,4	
			10.07-12.08	88	Ricam.Nr 7066347→	JBH, LLE	0 986 480 858	25,4	
	1.9 JTDM 8V, JTDM 16V, JTS	OFD	03.06-12.08	85/88/100/110/118		JBH, LLE	0 986 480 858	25,4	
	1.9 JTDM 16V	MFD	03.06-12.08	100		JBH, LLE	0 986 480 993	25,4	
	1.9 JTDM 16V	MFD	03.06-12.08	110/118		JBH, LLE	0 986 480 993	25,4	
	1.9 JTS		10.07-12.08	110/118	Ricam.Nr 7066347→	JBH, LLE	0 986 480 858	25,4	
	2.0 JTDM		05.09-12.11	120		JBH, LLE	0 986 480 858	25,4	
	2.2 JTS	MFD	03.06-12.08	136		JBH, LLE	0 986 480 993	25,4	
			10.07-12.08	136	Ricam.Nr 7066347→	JBH, LLE	0 986 480 858	25,4	
		OFD	03.06-12.08	136		JBH, LLE	0 986 480 858	25,4	
	2.4 JTD 20V		02.07-12.08	154		JBH, LLE	0 986 480 858	25,4	
		MFD	10.07-12.08	154	Ricam.Nr 7066347→	JBH, LLE	0 986 480 858	25,4	
	2.4 JTDM 20V	MFD	03.06-09.06	147	Ricam.Nr →7066346	JBH, LLE	0 986 480 993	25,4	
			10.06-12.08	147	Ricam.Nr 7066347→	JBH, LLE	0 986 480 858	25,4	
		OFD	03.06-09.06	147	Ricam.Nr →7066346	JBH, LLE	0 986 480 858	25,4	
	3.2 JTS	MFD	08.07-12.08	195	Ricam.Nr 7066347→	JBH, LLE	0 986 480 858	25,4	
	1.9 JTDM 8V, JTDM 16V, JTS		03.06-12.08	85/88/100/110/118			0 986 486 579	34	
	2.0 JTDM		05.09-12.11	120			0 986 486 579	34	
	2.2 JTS		03.06-12.08	136			0 986 486 579	34	
	2.4 JTD 20V, JTDM 20V		03.06-12.08	147/154			0 986 486 579	34	
	3.2 JTS		08.07-12.08	195			0 986 486 579	34	
159 Sportwagon [939]									
									
	1.8 i	MFD	03.06-12.08	103		JBH, LLE	0 986 480 993	25,4	
			10.07-12.08	103	Ricam.Nr 7066347→	JBH, LLE	0 986 480 858	25,4	
		OFD	03.06-12.08	103		JBH, LLE	0 986 480 858	25,4	
	1.8 i		03.06-12.08	103			0 986 486 588	31	
164 [164]									
									
	2.0 T.S.		09.92-10.98	106/148		LLE	0 204 162 078		
	2.0 V6 Turbo					RLE	0 204 162 083		
	2.5 D Turbo		09.92-10.98	92		LLE	0 204 162 078		
						RLE	0 204 162 083		





ALFA ROMEO 164 [164]									
	3.0 Q4 4x4, V6 12V, V6 24V, V6 24V Q.V., V6 24V Q.V. G.D.	09.92-10.98	132/145/155/169-171	LLE	0 204	162 078			
				RLE	0 204	162 083			
	2.0 T.S.	09.92-10.98	106	RLE	F 026	005 580	25,4		
		06.95-10.98	106	LLE	0 204	163 079			
	2.0 V6 Turbo	09.92-10.98	148		F 026	005 580	25,4		
	2.5 D Turbo	09.92-10.98	92		F 026	005 580	25,4		
	3.0 Q4 4x4, V6 24V, V6 24V Q.V., V6 24V Q.V. G.D.	09.92-10.98	155/169-171		F 026	005 580	25,4		
	3.0 V6 12V	09.92-10.98	132/145	RLE	F 026	005 580	25,4		
		06.95-10.98	132/145	LLE	0 204	163 079			
	2.0 T.S., V6 Turbo	09.92-10.98	106/148		0 204	131 202			
	2.5 D Turbo	09.92-10.98	92		0 204	131 202			
	3.0 V6 12V, V6 24V, V6 24V Q.V., V6 24V Q.V. G.D.	09.92-10.98	132/145/155/169-171		0 204	131 202			
	2.0 T.S.	09.92-10.98	106	Fg.-Nr. 6313824→	0 265	204 006^B			
	2.0 V6 Turbo	09.92-10.98	148		0 265	201 016^H			
	2.5 D Turbo	09.92-10.98	92	Fg.-Nr. 6313824→	0 265	204 006^B			
	3.0 V6 12V	09.92-10.98	132/145	Fg.-Nr. 6313824→	0 265	204 006^B			
	3.0 V6 24V	09.92-10.98	155	Fg.-Nr. 6330051→	0 265	216 425^B			
	3.0 V6 24V Q.V., V6 24V Q.V. G.D.	09.92-10.98	169-171	Fg.-Nr. 6313824→	0 265	204 006^B			
	2.0 V6 Turbo	09.92-10.98	148	Fg.-Nr. →TEL6190926	0 265	100 034^H			
				Fg.-Nr. TEL6190927→	0 265	100 051^H			
166 [936]									
	2.0 T.S. 16V, Turbo V6	10.98-06.03	110/114/151	LLE	F 009	D00 856			
		2.4 JTD	10.98-06.03	100-110	LLE	F 009	D00 856		
		2.5 V6 24V	07.98-06.03	140	LLE	F 009	D00 856		
		3.0 V6 24V	10.98-06.03	166	LLE	F 009	D00 856		
	2.0 T.S. 16V, Turbo V6	10.98-10.07	110/114/151		0 204	163 077			
		2.4 JTD, JTD 20V, JTDM 20V	10.98-10.07	100-110/120/128/129/132-136		0 204	163 077		
		2.5 V6 24V	07.98-10.07	140		0 204	163 077		
		3.0 V6 24V	10.98-10.07	166		0 204	163 077		
		3.2 V6 24V	06.03-10.07	176,5		0 204	163 077		
	2.0 T.S. 16V	10.98-09.00	114	AG	0 265	216 500^B			
				GS	0 265	216 621^B			
				TW	0 265	220 415^F			
					0 265	220 454^F			
					0 265	225 094^T			
		09.00-09.02	110		0 265	216 500^B			
				TW	0 265	220 415^F			
					0 265	220 603^F			
		10.02-10.07	110		0 265	225 196^T			
					0 265	220 454^F			
					0 265	220 603^F			
		2.0 Turbo V6	10.98-09.00	151	TW	0 265	220 454^F		
			10.00-12.04	151		0 265	220 603^F		
		2.4 JTD	10.98-09.00	100	AG	0 265	216 500^B		
					GS	0 265	216 621^B		
TW	0 265				220 415^F				
	0 265				220 454^F				
	0 265				220 454^F				
	0 265				225 094^T				
	0 265				216 500^B				
	0 265				216 621^B				
09.00-09.00	100-110		TW	0 265	220 454^F				
			0 265	225 094^T					
			0 265	216 500^B					
09.00-09.02	100-110		AG	0 265	216 500^B				
			GS	0 265	216 621^B				
			TW	0 265	220 415^F				
10.02-10.07	100-110			0 265	220 454^F				
			0 265	225 196^T					



	S							
2.4 JTD 20V, JTD 20V	06.03-10.07	120/128/129/132-136				0 265 225 196 ^T		
2.5 V6 24V	07.98-09.00	140			TW	0 265 220 454 ^F		
	07.98-12.06	140			AG	0 265 216 500 ^B		
					GS	0 265 216 621 ^B		
	07.98-10.07	140			TW	0 265 220 415 ^F		
	09.00-09.02	140				0 265 225 094 ^T		
	09.00-10.07	140				0 265 216 500 ^B		
					TW	0 265 220 603 ^F		
	10.02-10.07	140				0 265 225 196 ^T		
3.0 V6 24V	10.98-09.00	166				0 265 225 004 ^T		
					AG	0 265 216 500 ^B		
					GS	0 265 216 621 ^B		
					TW	0 265 220 454 ^F		
	10.98-10.07	166				0 265 216 500 ^B		
					TW	0 265 220 415 ^F		
	09.00-09.02	166				0 265 225 094 ^T		
09.00-10.07	166			TW	0 265 220 603 ^F			
	10.02-10.07	166				0 265 225 196 ^T		
3.2 V6 24V	06.03-10.07	176,5				0 265 225 196 ^T		
	2.0 T.S. 16V	10.98-08.04	110/151	Fg.-Nr. →94869		0 265 005 277		
	2.0 Turbo V6	09.04-10.07	110/151	Fg.-Nr. 94870→		0 265 005 241		
	2.4 JTD	09.00-08.04	100-110	Fg.-Nr. →94869		0 265 005 277		
		09.04-10.07	100-110	Fg.-Nr. 94870→		0 265 005 241		
	2.4 JTD 20V	06.03-08.04	129	Fg.-Nr. →94869		0 265 005 277		
		09.04-10.07	129	Fg.-Nr. 94870→		0 265 005 241		
		10.04-10.07	120/128	Fg.-Nr. 94870→		0 265 005 241		
	2.4 JTD 20V	10.05-10.07	132-136	Fg.-Nr. 94870→		0 265 005 241		
	2.5 V6 24V	09.00-08.04	140	Fg.-Nr. →94869		0 265 005 277		
		09.04-10.07	140	Fg.-Nr. 94870→		0 265 005 241		
	3.0 V6 24V	09.00-08.04	166	Fg.-Nr. →94869		0 265 005 277		
		09.04-10.07	166	Fg.-Nr. 94870→		0 265 005 241		
	3.2 V6 24V	06.03-08.04	176,5	Fg.-Nr. →94869		0 265 005 277		
		09.04-10.07	176,5	Fg.-Nr. 94870→		0 265 005 241		
		2.0 T.S. 16V, Turbo V6	10.98-10.07	110/114/151			0 265 005 303	
2.4 JTD, JTD 20V, JTD 20V		10.98-10.07	100-110/120/128/129/132-136			0 265 005 303		
2.5 V6 24V		07.98-10.07	140			0 265 005 303		
3.0 V6 24V		10.98-10.07	166			0 265 005 303		
3.2 V6 24V		06.03-10.07	176,5			0 265 005 303		

ALPINA (B.BOVENSIEPEN KG)

B7 [E65/66]

							
	4.4	12.03-06.08	368		JBH	0 986 481 026	27
	4.4	12.03-06.08	368			0 265 225 414 ^T	
	4.4	12.03-06.08	368			0 265 005 285	
	4.4	12.03-06.08	368			0 265 005 303	

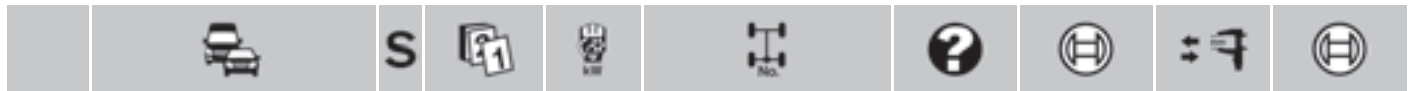

◀ ALPINA

Roadster [Z8]



	V8	06.02-10.03	280			0 265 225 255 ^T	
	V8	06.02-10.03	280			0 265 005 248	
	V8	06.02-10.03	280			0 265 005 303	

AUDI

A1 Sportback [8X]



















	1.0 TFSI	03.15->	70			0 986 486 554	19,05		
	1.2 TFSI	01.12-04.15	63	PR-Code OEJ	MQ2	0 986 486 553	19,05		
				PR-Code OEM	MQ0	0 986 486 554	19,05		
	1.4 TFSI	11.11-04.15	90	PR-Code OEJ	MQ2	0 986 486 553	19,05		
				PR-Code OEM	MQ0	0 986 486 554	19,05		
				136	PR-Code OEJ	MQ2	0 986 486 553	19,05	
					PR-Code OEM	MQ0	0 986 486 554	19,05	
				05.12-04.15	90	PR-Code OEJ	MQ2	0 986 486 553	19,05
				02.13-04.15	103	PR-Code OEJ	MQ2	0 986 486 553	19,05
	PR-Code OEM	MQ0	0 986 486 554			19,05			
	11.14->	92			0 986 486 554	19,05			
					0 986 486 554	19,05			
	1.6 TDI	11.11-04.15	66/77	PR-Code OEJ	MQ2	0 986 486 553	19,05		
				PR-Code OEM	MQ0	0 986 486 554	19,05		
2.0 TDI	09.11-04.15	105			0 986 486 553	19,05			
	05.12-04.15	100	PR-Code OEJ	MQ2	0 986 486 553	19,05			
PR-Code OEM			MQ0	0 986 486 554	19,05				

A1 [8X]



	1.0 TFSI	03.15->	70			0 986 486 554	19,05
	1.2 TFSI	05.10-04.15	63	PR-Code OEJ	MQ2	0 986 486 553	19,05
				PR-Code OEM	MQ0	0 986 486 554	19,05
	1.4 TDI	11.14->	110			0 986 486 554	19,05
	1.4 TFSI	05.10-04.15	90	PR-Code OEJ	MQ2	0 986 486 553	19,05
				PR-Code OEM	MQ0	0 986 486 554	19,05
		01.11-04.15	136	PR-Code OEJ	MQ2	0 986 486 553	19,05
				PR-Code OEM		0 986 486 554	19,05
		11.11-04.15	90	PR-Code OEJ	MQ2	0 986 486 553	19,05
		05.12-04.15	136	PR-Code OEM	MQ0	0 986 486 554	19,05
		02.13-04.15	103	PR-Code OEJ	MQ2	0 986 486 553	19,05
				PR-Code OEM	MQ0	0 986 486 554	19,05
		11.14->	92			0 986 486 554	19,05
		1.6 TDI	05.10-04.15	66/77	PR-Code OEJ	MQ2	0 986 486 553
	PR-Code OEM				MQ0	0 986 486 554	19,05
	2.0 TDI	09.11-04.15	100/105			0 986 486 553	19,05
	2.0 TFSI quattro	03.12-12.12	188	PR-Code OEJ	MQ2	0 986 486 553	19,05
				PR-Code OEM	MQ0	0 986 486 554	19,05

		S							
A2 [8Z0]									
									
	1.2 TDI 3L	03.01-09.01	45	Fg.-Nr. →8Z..2..013 000	JBH, LLE	0 986 481 008	22,2		
		10.01-10.02	45	Fg.-Nr. 8Z..2..013 001→ 8Z..3..019 000	JBH, LLE	0 986 481 009	22,2		
	1.4	10.01-04.02	55	Fg.-Nr. 8Z..2..013 001→	JBH, LLE	0 986 481 009	22,2		
		11.01-10.02	55	Fg.-Nr. →8Z..3..019 000	JBH, LLE	0 986 481 009	22,2		
	1.4	09.99-09.01	55	Fg.-Nr. →8Z..2..013 000	JBH, LLE	0 986 481 008	22,2		
	1.4 TDI								
	1.4 TDI	10.01-10.02	55	Fg.-Nr. 8Z..2..013 001→ 8Z..3..019 000	JBH, LLE	0 986 481 009	22,2		
	1.6 FSI	01.02-10.02	81	Fg.-Nr. →8Z..3..019 000	JBH, LLE	0 986 481 009	22,2		
	1.4	09.99-09.01	55	Fg.-Nr. →8Z..2..011 846		0 986 486 553	19,05		
	1.4 TDI	09.99-09.01	55	Fg.-Nr. →8Z..2..011 918		0 986 486 553	19,05		
A3 Cabriolet [8P7]									
									
	1.2 TFSI	03.10-05.13	77		BO	F 026 003 715	22,2		
					JBH, LLE	ATE 0 986 480 870	22		
	1.4 TFSI	02.11-05.13	92		BO	F 026 003 715	22,2		
					JBH, LLE	ATE 0 986 480 870	22		
	1.6	09.08-05.13	75/77		BO	F 026 003 715	22,2		
	1.6 TDI				JBH, LLE	ATE 0 986 480 870	22		
	1.8 TFSI	04.08-05.13	118		BO	F 026 003 715	22,2		
					JBH, LLE	ATE 0 986 480 870	22		
	1.9 TDI	04.08-05.09	77		BO	F 026 003 715	22,2		
					JBH, LLE	ATE 0 986 480 870	22		
	2.0 TDI	04.08-05.13	100/103		BO	F 026 003 715	22,2		
					JBH, LLE	ATE 0 986 480 870	22		
	2.0 TFSI	04.08-05.13	147		BO	F 026 003 715	22,2		
	1.2 TFSI	03.10-05.13	77		BO	0 204 055 051			
	1.4 TFSI	02.11-05.13	92		BO	0 204 055 051			
	1.6, TDI	09.08-05.13	75/77		BO	0 204 055 051			
	1.8 TFSI	04.08-05.13	118		BO	0 204 055 051			
	1.9 TDI	04.08-05.09	77		BO	0 204 055 051			
	2.0 TDI, TFSI	04.08-05.13	100/103/147		BO	0 204 055 051			
	1.2 TFSI	03.10-05.13	77			0 986 486 554	19,05		
	1.4 TFSI	02.11-05.13	92			0 986 486 554	19,05		
	1.6, TDI	09.08-05.13	75/77	PR-Code OEM	MQO	0 986 486 554	19,05		
	1.8 TFSI	04.08-05.13	118	PR-Code OEM	MQO	0 986 486 554	19,05		
	1.9 TDI	04.08-05.09	77	PR-Code OEM	MQO	0 986 486 554	19,05		
	2.0 TDI	04.08-04.11	100/103			0 986 486 595	29		
	2.0 TFSI	04.08-05.13	147			0 986 486 595	29		
A3 Cabriolet [8V7]									
									
	1.4 TFSI	10.13→	92/103/110	PR-Code OEC	MQO	0 986 486 554	19,05		
	1.6 TDI	02.14-05.15	81	PR-Code OEC	MQO	0 986 486 554	19,05		
	1.8 TFSI, TFSI quattro	10.13→	125/132	PR-Code OEC	MQO	0 986 486 554	19,05		
	2.0 TDI, TDI quattro, TFSI quattro	10.13→	100/110/ 135/162	PR-Code OEC	MQO	0 986 486 554	19,05		

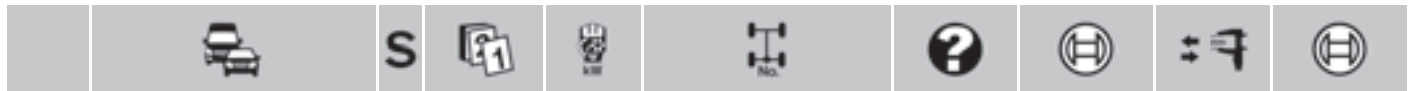

◀ AUDI

A3 Limousine [8VS]



	1.2 TFSI	10.13→	77/81	PR-Code OEC	MQO	0 986 486 554	19,05
	1.4 TFSI	09.13→	90/92/103	PR-Code OEC	MQO	0 986 486 554	19,05
	1.6 TDI	09.13→	77/81	PR-Code OEC	MQO	0 986 486 554	19,05
	1.8 FSI, TFSI, TFSI quattro	05.13→	125/132	PR-Code OEC	MQO	0 986 486 554	19,05
	2.0 TDI, TDI quattro, TFSI quattro	05.13→	81/105/ 110/206	PR-Code OEC	MQO	0 986 486 554	19,05

A3 Sportback [8PA]



	1.2 TFSI	11.09-08.12	77		BO	F 026 003 715	22,2	
					JBH,LLE	ATE	0 986 480 870	22
	1.4 TFSI	06.07-03.13	92		BO	F 026 003 715	22,2	
					JBH,LLE	ATE	0 986 480 870	22
	1.6	09.04-05.05	75		LLE	BO	F 026 003 715	22,2
					JBH,LLE	ATE	0 986 480 870	22
					BO	F 026 003 715	22,2	
	1.6 FSI	09.04-09.07	85		LLE	BO	F 026 003 715	22,2
					JBH,LLE	ATE	0 986 480 870	22
	1.6 TDI	05.09-03.13	66		BO	F 026 003 715	22,2	
					JBH,LLE	ATE	0 986 480 870	22
					BO	F 026 003 715	22,2	
	1.8 TFSI	11.06-06.08	118		LLE	BO	F 026 003 715	22,2
					BO	F 026 003 715	22,2	
	1.8 TFSI quattro	07.08-08.12	118		BO	F 026 003 715	22,2	
					JBH,LLE	ATE	0 986 480 870	22
	1.8 TFSI, TFSI quattro	11.06-03.13	118		BO	F 026 003 715	22,2	
					JBH,LLE	ATE	0 986 480 870	22
	1.9 TDI	09.04-05.10	77		LLE	BO	F 026 003 715	22,2
					JBH,LLE	ATE	0 986 480 870	22
	2.0 FSI, 2.0 TDI	09.04-06.08	110/120		LLE	BO	F 026 003 715	22,2
					JBH,LLE	ATE	0 986 480 870	22
	2.0 TDI	09.04-06.08	100/103		LLE	BO	F 026 003 715	22,2
					JBH,LLE	ATE	0 986 480 870	22
					LLE	BO	F 026 003 715	22,2
					BO	F 026 003 715	22,2	
	2.0 TDI quattro	09.04-03.13	100/103		JBH,LLE	ATE	0 986 480 870	22
					LLE	BO	F 026 003 715	22,2
					BO	F 026 003 715	22,2	
	2.0 TFSI	09.04-09.08	147		BO	F 026 003 715	22,2	
					JBH,LLE	ATE	0 986 480 870	22
					BO	F 026 003 715	22,2	
	2.0 TFSI quattro	07.08-03.13	147		LLE	BO	F 026 003 715	22,2
					BO	F 026 003 715	22,2	
	3.2 quattro	09.04-10.05	184		LLE	BO	F 026 003 715	22,2

	1.2 TFSI	11.09-08.12	77		BO	0 204 055 051	
					BO	0 204 055 051	
	1.4 TFSI	06.07-03.13	92		BO	0 204 055 051	
					BO	0 204 055 051	
	1.6	09.04-05.05	75	PR-Code 1AC, PR-Code 1AT	LLE	BO	0 204 055 051
					BO	0 204 055 051	
	1.6 FSI	06.05-03.13	75	PR-Code 1AC, PR-Code 1AT	LLE	BO	0 204 055 051
					BO	0 204 055 051	
	1.6 TDI	09.04-09.07	85	PR-Code 1AC, PR-Code 1AT	LLE	BO	0 204 055 051
					BO	0 204 055 051	
	1.8 TFSI	05.09-03.13	66		BO	0 204 055 051	
					BO	0 204 055 051	
	1.8 TFSI	11.06-06.07	118	PR-Code 1AC, PR-Code 1AT	LLE	BO	0 204 055 051
					BO	0 204 055 051	
	1.8 TFSI quattro	06.07-08.12	118		BO	0 204 055 051	
					BO	0 204 055 051	
	1.9 TDI	07.08-03.13	118		BO	0 204 055 051	
	2.0 FSI, TDI	09.04-05.10	77	PR-Code 1AC, PR-Code 1AT	LLE	BO	0 204 055 051
					BO	0 204 055 051	
	2.0 FSI, TDI	09.04-06.08	110/120	PR-Code 1AC, PR-Code 1AT	LLE	BO	0 204 055 051
					BO	0 204 055 051	
	2.0 TDI	09.04-06.08	100/103	PR-Code 1AC, PR-Code 1AT	LLE	BO	0 204 055 051
					BO	0 204 055 051	
	2.0 TDI quattro	07.08-03.13	100/103		BO	0 204 055 051	
					BO	0 204 055 051	
	2.0 TDI, TDI quattro, TFSI	09.04-05.09	125/147	PR-Code 1AC, PR-Code 1AT	LLE	BO	0 204 055 051
					BO	0 204 055 051	
	2.0 TFSI quattro	04.05-08.13	125/147		BO	0 204 055 051	
					BO	0 204 055 051	
	3.2 quattro	09.04-05.09	125/147	PR-Code 1AC, PR-Code 1AT	LLE	BO	0 204 055 051
					BO	0 204 055 051	



	1.2 TFSI	11.09-08.12	77			0 986 486 554	19,05
	1.4 TFSI	06.07-06.11	92	PR-Code OEJ	MQ2	0 986 486 576	19
		06.07-03.13	92	PR-Code OEM	MQ0	0 986 486 554	19,05
	1.6	09.04-03.13	75			0 986 486 554	19,05
		06.05-08.12	75	PR-Code OEM	MQ0	0 986 486 554	19,05
	1.6 FSI	09.04-09.07	85			0 986 486 554	19,05
	1.6 TDI	05.09-03.13	66	PR-Code OEM	MQ0	0 986 486 554	19,05
		11.09-03.13	77	PR-Code OEM	MQ0	0 986 486 554	19,05
	1.8 TFSI, TFSI quattro	11.06-03.13	118	PR-Code OEM	MQ0	0 986 486 554	19,05
	1.9 TDI	09.04-05.10	77	PR-Code OEM	MQ0	0 986 486 554	19,05
	2.0 FSI	09.04-06.08	110	PR-Code OEJ	MQ2	0 986 486 576	19
				PR-Code OEM	MQ0	0 986 486 554	19,05
	2.0 TDI	09.04-03.13	100/103			0 986 486 595	29
	2.0 TDI quattro	03.06-03.13	120/125			0 986 486 595	29
	2.0 TFSI	09.04-10.05	147			0 986 486 595	29
		09.07-08.13	147			0 986 486 595	29
	2.0 TFSI quattro	09.04-10.05	147			0 986 486 595	29
		07.08-03.13	147			0 986 486 595	29
	2.0 TFSI, TFSI quattro	04.05-05.09	147	PR-Code OEM	MQ0	0 986 486 554	19,05
	3.2 quattro	09.04-05.09	184			0 986 486 595	29

A3 Sportback [8VA]

	1.4 TFSI e-tron	05.14→	110		LLE	0 204 819 790	
					RLE	0 204 819 792	
	1.2 TFSI	05.13→	77/81	PR-Code OEC	MQ0	0 986 486 554	19,05
	1.4 TFSI, TFSI g-tron	09.12→	81/90/103	PR-Code OEC	MQ0	0 986 486 554	19,05
	1.6 TDI	01.13→	77/81	PR-Code OEC	MQ0	0 986 486 554	19,05
	1.8 FSI quattro, TFSI	09.12→	132	PR-Code OEC	MQ0	0 986 486 554	19,05
	2.0 TDI, TDI quattro	03.13→	81/105/110	PR-Code OEC	MQ0	0 986 486 554	19,05

A3 [8L1]

	1.6	05.99-09.06	74			F 026 003 339	23,81
		OFD 09.96-06.01	74		LLE	F 026 003 339	23,81
					RLE	0 204 123 406	23,81
		05.00-06.03	75		LLE	F 026 003 339	23,81
					RLE	0 204 123 406	23,81
	1.8	05.99-09.06	92			F 026 003 339	23,81
		OFD 09.96-06.03	92		LLE	F 026 003 339	23,81
	1.8, quattro	OFD 09.96-06.03	92		RLE	0 204 123 406	23,81
	1.8 quattro	OFD 08.98-06.99	92		LLE	F 026 003 339	23,81
	1.8 T	05.99-09.06	110			F 026 003 339	23,81
		03.00-09.06	132			F 026 003 339	23,81
		OFD 12.96-06.03	110		LLE	F 026 003 339	23,81
		08.98-06.03	132		LLE	F 026 003 339	23,81
	1.8 T quattro	OFD 08.97-06.03	110		LLE	F 026 003 339	23,81
		08.98-06.03	132		LLE	F 026 003 339	23,81
	1.8 T	OFD 12.96-06.03	110		RLE	0 204 123 406	23,81
	1.8 T quattro	08.98-06.03	132		RLE	0 204 123 406	23,81
	1.9 TDI	01.00-09.06	81			F 026 003 339	23,81
		OFD 09.96-06.03	66/74		LLE	F 026 003 339	23,81
					RLE	0 204 123 406	23,81
		01.97-06.01	81		LLE	F 026 003 339	23,81
					RLE	0 204 123 406	23,81
	1.9 TDI	OFD 05.00-06.03	96		LLE	F 026 003 339	23,81
	1.9 TDI quattro				RLE	0 204 123 406	23,81

















◀ AUDI A3 [8L1]

	1.6	OFD	09.96-06.03	74/75	RLE	0 204 125 505		
	1.8, quattro, T, T quattro	OFD	09.96-06.03	92/110/132	RLE	0 204 125 505		
	1.9 TDI, TDI quattro	OFD	09.96-06.03	66/74/81/96	RLE	0 204 125 505		
	1.6		09.96-06.01	74	LLE	0 986 486 031	15,87	
					RLE	0 986 486 047	15,87	
			05.00-04.02	75	RLE	0 986 486 047	15,87	
			05.00-06.03	75	LLE	0 986 486 031	15,87	
			05.02-06.03	75	RLE	0 986 486 060	15,87	
		1.8		09.96-06.03	92/110/132	RLE	0 986 486 047	15,87
		1.8, quattro, T, T quattro		09.96-06.03	92/110/132	LLE	0 986 486 031	15,87
		1.8, T, T quattro		03.02-06.03	92/110/132 Fg.-Nr. 8L...2..090 001→	RLE	0 986 486 060	15,87
		1.8 quattro		08.98-06.99	92/110/132	RLE	0 986 486 047	15,87
		1.8 T, T quattro		12.96-03.02	92/110/132 Fg.-Nr. →8L...2..090 000	RLE	0 986 486 047	15,87
				08.97-06.01	92/110/132	RLE	0 986 486 047	15,87
		1.9 TDI		09.96-06.01	66	LLE	0 986 486 031	15,87
						RLE	0 986 486 047	15,87
				01.97-06.01	81	LLE	0 986 486 031	15,87
						RLE	0 986 486 047	15,87
				09.00-03.02	74	Fg.-Nr. →8L...2..090 000	RLE	0 986 486 047
				09.00-06.03	74	LLE	0 986 486 031	15,87
				03.02-06.03	74	Fg.-Nr. 8L...2..090 001→	RLE	0 986 486 060
	1.9 TDI, TDI quattro		05.00-03.02	96	Fg.-Nr. →8L...2..090 000	RLE	0 986 486 047	15,87
			05.00-06.03	96	LLE	0 986 486 031	15,87	
			03.02-06.03	96	Fg.-Nr. 8L...2..090 001→	RLE	0 986 486 060	15,87
	1.6		09.96-06.03	74/75	FSG	0 986 486 542	23,81	
					FSZ	0 986 486 538	19	
	1.8, quattro, T, T quattro		09.96-06.03	92/110/132	FSG	0 986 486 542	23,81	
					FSZ	0 986 486 538	19	
	1.9 TDI, TDI quattro		09.96-06.03	66/74/81/96	FSG	0 986 486 542	23,81	
				FSZ	0 986 486 538	19		









A3 [8P1]

	1.2 TFSI		04.10-03.13	77	BO	F 026 003 715	22,2	
					JBH,LLE	ATE	0 986 480 870	22
	1.4 TFSI		09.07-03.13	92	BO	F 026 003 715	22,2	
					JBH,LLE	ATE	0 986 480 870	22
	1.6		05.03-05.05	75	LLE	BO	F 026 003 715	22,2
			05.03-03.13	75	JBH,LLE	ATE	0 986 480 870	22
			06.05-03.13	75	BO	F 026 003 715	22,2	
	1.6 FSI		08.03-09.07	85	LLE	BO	F 026 003 715	22,2
					JBH,LLE	ATE	0 986 480 870	22
	1.6 TDI		05.09-03.13	66	BO	F 026 003 715	22,2	
					JBH,LLE	ATE	0 986 480 870	22
			11.09-08.12	77	BO	F 026 003 715	22,2	
					JBH,LLE	ATE	0 986 480 870	22
	1.8 TFSI		11.06-05.08	118	LLE	BO	F 026 003 715	22,2
					JBH,LLE	ATE	0 986 480 870	22
			07.08-08.12	118	BO	F 026 003 715	22,2	
					JBH,LLE	ATE	0 986 480 870	22
	1.8 TFSI quattro		07.08-03.13	118	BO	F 026 003 715	22,2	
					JBH,LLE	ATE	0 986 480 870	22
	1.9 TDI		06.03-05.10	77	LLE	BO	F 026 003 715	22,2
			11.05-05.10	77	JBH,LLE	ATE	0 986 480 870	22
2.0 FSI		05.03-10.05	110	JBH,LLE	ATE	0 986 480 870	22	
		05.03-06.08	110	LLE	BO	F 026 003 715	22,2	
2.0 TDI		06.06-06.08	120	LLE	BO	F 026 003 715	22,2	
				JBH,LLE	ATE	0 986 480 870	22	

		S							
2.0 TDI		05.03-05.10	100/103			LLE	BO	F 026 003 715	22,2
2.0 TDI quattro		05.03-03.13	100/103			JBH,LLE	ATE	0 986 480 870	22
		03.06-05.10	125			LLE	BO	F 026 003 715	22,2
		09.08-03.13	100/103			BO	F 026 003 715	22,2	
		11.09-03.13	125			BO	F 026 003 715	22,2	
2.0 TFSI		09.04-06.08	147			JBH,LLE	ATE	0 986 480 870	22
2.0 TFSI quattro		09.04-10.05	147			JBH,LLE	ATE	0 986 480 870	22
		11.05-10.06	147	Fg.-Nr. ->8P..7..103 000		JBH,LLE	ATE	0 986 480 870	22
2.0 TFSI		09.04-06.08	147			LLE	BO	F 026 003 715	22,2
2.0 TFSI quattro		07.08-03.13	147				BO	F 026 003 715	22,2
3.2 quattro		07.03-10.05	184			LLE	BO	F 026 003 715	22,2
	1.2 TFSI	04.10-03.13	77				BO	0 204 055 051	
	1.4 TFSI	09.07-03.13	92				BO	0 204 055 051	
	1.6	05.03-05.05	75	PR-Code 1AC, PR-Code 1AT	LLE		BO	0 204 055 051	
		06.05-03.13	75				BO	0 204 055 051	
	1.6 FSI	08.03-09.07	85	PR-Code 1AC, PR-Code 1AT	LLE		BO	0 204 055 051	
	1.6 TDI	05.09-03.13	66				BO	0 204 055 051	
		11.09-08.12	77				BO	0 204 055 051	
	1.8 TFSI	11.06-06.07	118	PR-Code 1AC, PR-Code 1AT	LLE		BO	0 204 055 051	
		06.07-05.08	118				BO	0 204 055 051	
		07.08-08.12	118				BO	0 204 055 051	
	1.8 TFSI quattro	07.08-03.13	118				BO	0 204 055 051	
	1.9 TDI	06.03-05.10	77	PR-Code 1AC, PR-Code 1AT	LLE		BO	0 204 055 051	
	2.0 FSI, TDI	05.03-06.08	110/120	PR-Code 1AC, PR-Code 1AT	LLE		BO	0 204 055 051	
	2.0 TDI	05.03-06.08	100/103	PR-Code 1AC, PR-Code 1AT	LLE		BO	0 204 055 051	
	2.0 TDI quattro	07.08-03.13	100/103				BO	0 204 055 051	
	2.0 TDI, TDI quattro, TFSI	09.04-06.08	125/147	PR-Code 1AC, PR-Code 1AT	LLE		BO	0 204 055 051	
		10.07-03.13	125/147				BO	0 204 055 051	
	2.0 TFSI quattro	09.04-06.08	125/147	PR-Code 1AC, PR-Code 1AT	LLE		BO	0 204 055 051	
	3.2 quattro	07.03-10.05	184	PR-Code 1AC, PR-Code 1AT	LLE		BO	0 204 055 051	
	1.2 TFSI	04.10-03.13	77					0 986 486 554	19,05
	1.4 TFSI	09.07-06.11	92	PR-Code 0EJ	MQ2			0 986 486 576	19
		09.07-03.13	92	PR-Code OEM	MQ0			0 986 486 554	19,05
	1.6	05.03-03.13	75					0 986 486 554	19,05
		06.05-08.12	75	PR-Code OEM	MQ0			0 986 486 554	19,05
	1.6 FSI	08.03-09.07	85					0 986 486 554	19,05
	1.6 TDI	05.09-03.13	66	PR-Code OEM	MQ0			0 986 486 554	19,05
		11.09-08.12	77	PR-Code OEM	MQ0			0 986 486 554	19,05
	1.8 TFSI	11.06-05.08	118	PR-Code OEM	MQ0			0 986 486 554	19,05
		07.08-08.12	118	PR-Code OEM	MQ0			0 986 486 554	19,05
	1.8 TFSI quattro	07.08-03.13	118	PR-Code OEM	MQ0			0 986 486 554	19,05
	1.9 TDI	06.03-05.10	77	PR-Code OEM	MQ0			0 986 486 554	19,05
	2.0 FSI	05.03-06.08	110	PR-Code 0EJ	MQ2			0 986 486 576	19
				PR-Code OEM	MQ0			0 986 486 554	19,05
	2.0 TDI	05.03-03.13	100/103					0 986 486 595	29
	2.0 TDI quattro	03.06-03.13	120/125					0 986 486 595	29
	2.0 TFSI	09.04-10.05	147					0 986 486 595	29
		07.08-03.13	147					0 986 486 595	29
	2.0 TFSI quattro	09.04-10.05	147					0 986 486 595	29
		07.08-03.13	147					0 986 486 595	29
	2.0 TFSI, TFSI quattro	09.05-06.08	147	PR-Code OEM	MQ0			0 986 486 554	19,05
	3.2 quattro	07.03-05.09	184					0 986 486 595	29
A3 [8V1]									
									
	1.2 TFSI	12.12->	77/81	PR-Code OEC	MQ0			0 986 486 554	19,05
	1.4 TFSI	04.12->	90/103	PR-Code OEC	MQ0			0 986 486 554	19,05
	1.6 TDI	09.13->	81	PR-Code OEC	MQ0			0 986 486 554	19,05
	1.8 FSI quattro, TFSI	04.12->	132	PR-Code OEC	MQ0			0 986 486 554	19,05

	◀ AUDI A3 [8V1]									
	2.0 TDI	09.12→	77/81/105/	PR-Code OEC	MQO	0986 486 554	19,05			
	2.0 TDI quattro		110							
A4 Allroad [8KH]										
	2.0 TDI	04.09→	100/105/		FDS	0 265 005 741				
	2.0 TFSI		110/120/	PR-Code GP1	FDS	0 265 005 739				
	2.0 TFSI flexible fuel		125/130/							
			140/155/							
			162/165							
	3.0 TDI	04.09→	176/180		FDS	0 265 005 741				
				PR-Code GP1	FDS	0 265 005 739				
A4 Avant [8D5; B5]										
	1.6	11.94-10.96	74		JBH	0 986 480 890	23,81			
		10.96-12.98	74	Fg.-Nr. →8D..X..199 999	JBH	0 986 480 890	23,81			
	MFD	01.99-10.00	74	Fg.-Nr. 8D..X..200 001→	JBH,LLE	0 986 480 966	25,4			
					JBH,RLE	0 986 480 989	25,4			
		06.00-09.01	75		JBH,LLE	0 986 480 966	25,4			
					JBH,RLE	0 986 480 989	25,4			
	OFD	01.99-10.00	74	Fg.-Nr. 8D..X..200 001→	JBH,LLE	0 986 480 935	25,4			
		06.00-09.01	75		JBH,LLE	0 986 480 935	25,4			
	1.8	11.94-12.98	92	Fg.-Nr. →8D..X..199 999	JBH	0 986 480 890	23,81			
		07.95-12.98	85		JBH	0 986 480 890	23,81			
	MFD	01.99-07.99	92	Fg.-Nr. 8D..X..200 001→	JBH,LLE	0 986 480 966	25,4			
		04.99-07.99	92		JBH,LLE	0 986 480 966	25,4			
		06.00-09.01	92		JBH,LLE	0 986 480 966	25,4			
	1.8	01.99-06.00	92	Fg.-Nr. 8D..X..200 001→	JBH,RLE	0 986 480 989	25,4			
	1.8 quattro	04.99-09.01	92		JBH,RLE	0 986 480 989	25,4			
		01.99-06.00	92	Fg.-Nr. 8D..X..200 001→	JBH,LLE	0 986 480 935	25,4			
		04.99-09.01	92		JBH,LLE	0 986 480 935	25,4			
	1.8 quattro	11.94-12.98	92	Fg.-Nr. →8D..X..199 999	JBH	0 986 480 974	23,8			
		07.95-12.98	85	Fg.-Nr. →8D..X..199 999	JBH	0 986 480 974	23,8			
		01.99-06.00	92	Fg.-Nr. 8D..X..200 001→	JBH,LLE	0 986 480 966	25,4			
		01.99-09.01	85	Fg.-Nr. 8D..X..200 001→	JBH,LLE	0 986 480 966	25,4			
					JBH,RLE	0 986 480 989	25,4			
		04.99-09.01	92		JBH,LLE	0 986 480 966	25,4			
	OFD	11.94-12.98	92	Fg.-Nr. →8D..X..199 999	JBH	0 986 480 890	23,81			
		07.95-12.98	85	Fg.-Nr. →8D..X..199 999	JBH	0 986 480 890	23,81			
		01.99-09.01	85	Fg.-Nr. 8D..X..200 001→	JBH,LLE	0 986 480 935	25,4			
	1.8 T	10.95-07.98	110		JBH	0 986 480 890	23,81			
		08.97-12.98	132	Fg.-Nr. →8D..X..199 999	JBH	0 986 480 890	23,81			
		08.98-12.98	110	Fg.-Nr. →8D..X..199 999	JBH	0 986 480 890	23,81			
	MFD	01.99-09.01	110	Fg.-Nr. 8D..X..200 001→	JBH,LLE	0 986 480 966	25,4			
					JBH,RLE	0 986 480 989	25,4			
			132	Fg.-Nr. 8D..X..200 001→	JBH,LLE	0 986 480 966	25,4			
		05.99-07.99	110		JBH,LLE	0 986 480 966	25,4			
					JBH,RLE	0 986 480 989	25,4			
		06.00-09.01	110		JBH,LLE	0 986 480 966	25,4			
					JBH,RLE	0 986 480 989	25,4			
	OFD	01.99-09.01	110	Fg.-Nr. 8D..X..200 001→	JBH,LLE	0 986 480 935	25,4			
		05.99-07.99	110		JBH,LLE	0 986 480 935	25,4			
		06.00-09.01	110		JBH,LLE	0 986 480 935	25,4			
	1.8 T quattro	05.00-09.01	125		JBH	0 986 480 935	25,4			
	MFD	02.96-12.98	110		JBH	0 986 480 974	23,8			
		08.97-12.98	132	Fg.-Nr. →8D..X..199 999	JBH	0 986 480 974	23,8			
		01.99-09.01	132	Fg.-Nr. 8D..X..200 001→	JBH,LLE	0 986 480 966	25,4			
		02.99-09.01	110		JBH,LLE	0 986 480 966	25,4			
					JBH,RLE	0 986 480 989	25,4			







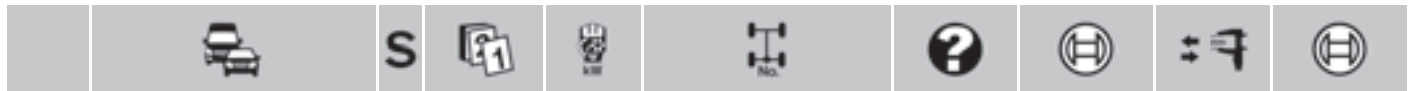



										
1.8 T quattro	OFD	02.96-12.98	110			JBH	0 986 480 890	23,81		
		08.97-12.98	132	Fg.-Nr. →8D..X..199 999		JBH	0 986 480 890	23,81		
		02.99-09.01	110			JBH,LLE	0 986 480 935	25,4		
1.8 T	MFD	01.99-09.01	132	Fg.-Nr. 8D..X..200 001→		JBH,RLE	0 986 480 989	25,4		
1.8 T quattro	OFD	01.99-09.01	132	Fg.-Nr. 8D..X..200 001→		JBH,LLE	0 986 480 935	25,4		
1.9 TDI		01.95-06.00	66			JBH	0 986 480 890	23,81		
		02.96-12.98	81			JBH	0 986 480 890	23,81		
		08.98-12.98	85	Fg.-Nr. →8D..X..199 999		JBH	0 986 480 890	23,81		
		MFD	01.99-09.01	66	Fg.-Nr. 8D..X..200 001→		JBH,LLE	0 986 480 966	25,4	
						JBH,RLE	0 986 480 989	25,4		
			85	Fg.-Nr. 8D..X..200 001→		JBH,LLE	0 986 480 966	25,4		
						JBH,RLE	0 986 480 989	25,4		
			08.99-06.00	81			JBH,LLE	0 986 480 966	25,4	
						JBH,RLE	0 986 480 989	25,4		
		OFD	01.99-09.01	66	Fg.-Nr. 8D..X..200 001→		JBH,LLE	0 986 480 935	25,4	
				85	Fg.-Nr. 8D..X..200 001→		JBH,LLE	0 986 480 935	25,4	
		08.99-06.00	81			JBH,LLE	0 986 480 935	25,4		
1.9 TDI quattro	MFD	07.96-12.98	81	Fg.-Nr. →8D..X..199 999		JBH	0 986 480 974	23,8		
		12.98-12.98	85			JBH	0 986 480 974	23,8		
		01.99-07.99	81	Fg.-Nr. 8D..X..200 001→		JBH,LLE	0 986 480 966	25,4		
						JBH,RLE	0 986 480 989	25,4		
			08.99-01.00	81			JBH,LLE	0 986 480 966	25,4	
						JBH,RLE	0 986 480 989	25,4		
			01.00-09.01	85			JBH,LLE	0 986 480 966	25,4	
						JBH,RLE	0 986 480 989	25,4		
		OFD	07.96-12.98	81	Fg.-Nr. →8D..X..199 999		JBH	0 986 480 890	23,81	
			12.98-12.98	85			JBH	0 986 480 890	23,81	
			01.99-07.99	81	Fg.-Nr. 8D..X..200 001→		JBH,LLE	0 986 480 935	25,4	
			08.99-01.00	81			JBH,LLE	0 986 480 935	25,4	
			01.00-09.01	85			JBH,LLE	0 986 480 935	25,4	
						JBH,LLE	0 986 480 935	25,4		
2.4		08.97-07.98	121			JBH	0 986 480 890	23,81		
		08.98-12.98	120	Fg.-Nr. →8D..X..199 999		JBH	0 986 480 890	23,81		
			121	Fg.-Nr. →8D..X..199 999		JBH	0 986 480 890	23,81		
		MFD	01.99-06.00	120	Fg.-Nr. 8D..X..200 001→		JBH,LLE	0 986 480 966	25,4	
						JBH,RLE	0 986 480 989	25,4		
			01.99-09.01	121	Fg.-Nr. 8D..X..200 001→		JBH,LLE	0 986 480 966	25,4	
						JBH,RLE	0 986 480 989	25,4		
			06.00-09.01	120			JBH,LLE	0 986 480 966	25,4	
						JBH,RLE	0 986 480 989	25,4		
		OFD	01.99-06.00	120	Fg.-Nr. 8D..X..200 001→		JBH,LLE	0 986 480 935	25,4	
			01.99-09.01	121	Fg.-Nr. 8D..X..200 001→		JBH,LLE	0 986 480 935	25,4	
			06.00-09.01	120			JBH,LLE	0 986 480 935	25,4	
	2.4 quattro	MFD	08.97-07.98	120			JBH	0 986 480 974	23,8	
		08.97-12.98	121			JBH	0 986 480 974	23,8		
		08.98-12.98	120	Fg.-Nr. →8D..X..199 999		JBH	0 986 480 974	23,8		
		01.99-06.00	120	Fg.-Nr. 8D..X..200 001→		JBH,LLE	0 986 480 966	25,4		
						JBH,RLE	0 986 480 989	25,4		
			01.99-09.01	121	Fg.-Nr. 8D..X..200 001→		JBH,LLE	0 986 480 966	25,4	
						JBH,RLE	0 986 480 989	25,4		
			02.99-07.99	121			JBH,LLE	0 986 480 966	25,4	
						JBH,RLE	0 986 480 989	25,4		
		OFD	08.97-07.98	120			JBH	0 986 480 890	23,81	
			08.97-12.98	121			JBH	0 986 480 890	23,81	
			08.98-12.98	120	Fg.-Nr. →8D..X..199 999		JBH	0 986 480 890	23,81	
			01.99-06.00	120	Fg.-Nr. 8D..X..200 001→		JBH,LLE	0 986 480 935	25,4	
			01.99-09.01	121	Fg.-Nr. 8D..X..200 001→		JBH,LLE	0 986 480 935	25,4	
			02.99-07.99	121			JBH,LLE	0 986 480 935	25,4	
						JBH,LLE	0 986 480 935	25,4		
2.5 TDI			11.97-12.98	110	Fg.-Nr. →8D..X..199 999		JBH	0 986 480 890	23,81	
		MFD	01.99-09.01	110	Fg.-Nr. 8D..X..200 001→		JBH,LLE	0 986 480 966	25,4	
2.5 TDI quattro		MFD	11.97-12.98	110	Fg.-Nr. →8D..X..199 999		JBH	0 986 480 974	23,8	
		01.99-06.00	110	Fg.-Nr. 8D..X..200 001→		JBH,LLE	0 986 480 966	25,4		
	OFD	11.97-12.98	110	Fg.-Nr. →8D..X..199 999		JBH	0 986 480 890	23,81		













◀ AUDI A4 Avant [8D5; B5]							
2.5 TDI	MFD	01.99-09.01	110	Fg.-Nr. 8D..X..200 001→	JBH,RLE	0986 480 989	25,4
2.5 TDI quattro	OFD	01.99-09.01	110	Fg.-Nr. 8D..X..200 001→	JBH,LLE	0986 480 935	25,4
2.6		11.94-07.98	110		JBH	0986 480 890	23,81
		01.96-07.97	102		JBH	0986 480 890	23,81
2.6 quattro	MFD	11.94-07.98	102/110		JBH	0986 480 974	23,8
	OFD	11.94-07.98	110		JBH	0986 480 890	23,81
2.8		01.96-07.97	102		JBH	0986 480 890	23,81
		03.96-07.98	142		JBH	0986 480 890	23,81
2.8		08.97-12.98	142	Fg.-Nr. →8D..X..199 999	JBH	0986 480 890	23,81
		01.99-08.99	142	Fg.-Nr. 8D..X..200 001→	JBH	0986 480 935	25,4
2.8	MFD	01.99-07.99	142	Fg.-Nr. 8D..X..200 001→	JBH,LLE	0986 480 966	25,4
					JBH,RLE	0986 480 989	25,4
2.8	OFD	01.99-07.99	142	Fg.-Nr. 8D..X..200 001→	JBH,LLE	0986 480 935	25,4
					JBH,LLE	0986 480 966	25,4
2.8 quattro	MFD	03.99-09.01	140		JBH,LLE	0986 480 966	25,4
					JBH,RLE	0986 480 989	25,4
2.8 quattro	OFD	03.99-09.01	140		JBH,LLE	0986 480 935	25,4
					JBH,LLE	0986 480 935	25,4
2.8 quattro		08.99-09.01	142		JBH	0986 480 935	25,4
	MFD	03.96-07.98	142		JBH	0986 480 974	23,8
2.8 quattro		08.98-12.98	142	Fg.-Nr. →8D..X..199 999	JBH	0986 480 974	23,8
		01.99-06.00	142	Fg.-Nr. 8D..X..200 001→	JBH,LLE	0986 480 966	25,4
2.8 quattro					JBH,RLE	0986 480 989	25,4
		02.99-09.01	142		JBH,LLE	0986 480 966	25,4
2.8 quattro					JBH,RLE	0986 480 989	25,4
	OFD	03.96-07.98	142		JBH	0986 480 890	23,81
2.8 quattro		08.98-12.98	142	Fg.-Nr. →8D..X..199 999	JBH	0986 480 890	23,81
		01.99-06.00	142	Fg.-Nr. 8D..X..200 001→	JBH,LLE	0986 480 935	25,4
2.8 quattro					JBH,LLE	0986 480 935	25,4
		02.99-09.01	142		JBH,LLE	0986 480 935	25,4
1.6		11.94-10.96	74		LLE	0986 486 083	19
		10.96-03.97	74	Fg.-Nr. →8D..V..180 000	LLE	0986 486 083	19
1.6		03.97-07.99	74	Fg.-Nr. 8D..V..180 001→	LLE	0986 486 054	19,05
		08.98-10.00	74		LLE	0986 486 054	19,05
1.6		06.00-09.01	75		LLE	0986 486 054	19,05
		03.97-12.98	85	Fg.-Nr. 8D..V..180 001→	LLE	0986 486 054	19,05
1.8 quattro		07.95-03.97	85	Fg.-Nr. →8D..V..180 000	LLE	0986 486 083	19
1.8 quattro, T, T quattro		11.94-03.97	92/110	Fg.-Nr. →8D..V..180 000	LLE	0986 486 083	19
		03.97-04.99	92/110	Fg.-Nr. 8D..V..180 001→	LLE	0986 486 054	19,05
1.8 quattro		08.98-09.01	92/110		LLE	0986 486 054	19,05
		07.95-09.01	85	Fg.-Nr. 8D-V 180 001→	LLE	0986 486 054	19,05
1.8 T quattro		05.00-09.01	125			0986 486 054	19,05
1.8 T, T quattro		08.97-09.01	132		LLE	0986 486 054	19,05
1.9 TDI		01.95-07.96	66		LLE	0986 486 083	19
		08.96-03.97	66	Fg.-Nr. →8D..V..180 000	LLE	0986 486 083	19
1.9 TDI		03.97-06.00	66	Fg.-Nr. 8D..V..180 001→	LLE	0986 486 054	19,05
		04.97-09.01	66		LLE	0986 486 054	19,05
1.9 TDI		02.96-03.97	81	Fg.-Nr. →8D..V..180 000	LLE	0986 486 083	19
1.9 TDI quattro		03.97-07.99	81	Fg.-Nr. 8D..V..180 001→	LLE	0986 486 054	19,05
		08.98-09.01	85		LLE	0986 486 054	19,05
1.9 TDI quattro		08.99-06.00	81		LLE	0986 486 054	19,05
		08.97-09.01	120/121		LLE	0986 486 054	19,05
2.5 TDI, TDI quattro		11.97-09.01	110		LLE	0986 486 054	19,05
2.6		11.94-03.97	102/110	Fg.-Nr. →8D..V..180 000	LLE	0986 486 083	19
2.6 quattro		03.97-07.98	102/110	Fg.-Nr. 8D..V..180 001→	LLE	0986 486 054	19,05
2.8		03.96-03.97	142	Fg.-Nr. →8D..V..180 000	LLE	0986 486 083	19
2.8 quattro		03.97-07.98	142	Fg.-Nr. 8D..V..180 001→	LLE	0986 486 054	19,05
		08.97-09.01	142			0986 486 054	19,05
2.8 quattro					LLE	0986 486 054	19,05
		03.99-09.01	140		LLE	0986 486 054	19,05
1.6		11.94-10.96	74			0986 486 551	22,2
		10.96-03.97	74	Fg.-Nr. →8D..V..180 000		0986 486 551	22,2
1.6		03.97-07.99	74	Fg.-Nr. 8D..V..180 001→		0986 486 548	22,2

		S							
1.6	08.98-10.00	74					0 986 486 548	22,2	
	06.00-09.01	75					0 986 486 548	22,2	
1.8	03.97-12.98	85	Fg.-Nr. 8D..V..180 001→				0 986 486 548	22,2	
1.8, quattro	07.95-03.97	85	Fg.-Nr. →8D..V..180 000				0 986 486 551	22,2	
1.8, quattro, T, T quattro	11.94-03.97	92/110	Fg.-Nr. →8D..V..180 000				0 986 486 551	22,2	
	03.97-04.99	92/110	Fg.-Nr. 8D..V..180 001→				0 986 486 548	22,2	
	08.98-09.01	92/110					0 986 486 548	22,2	
1.8 quattro	07.95-09.01	85					0 986 486 548	22,2	
1.8 T, T quattro	08.97-09.01	125/132					0 986 486 548	22,2	
1.9 TDI	01.95-07.96	66					0 986 486 551	22,2	
	08.96-03.97	66	Fg.-Nr. →8D..V..180 000				0 986 486 551	22,2	
	03.97-06.00	66	Fg.-Nr. 8D..V..180 001→				0 986 486 548	22,2	
	04.97-09.01	66					0 986 486 548	22,2	
1.9 TDI	02.96-03.97	81	Fg.-Nr. →8D..V..180 000				0 986 486 551	22,2	
1.9 TDI quattro	03.97-07.99	81	Fg.-Nr. 8D..V..180 001→				0 986 486 548	22,2	
	08.98-09.01	85					0 986 486 548	22,2	
	08.99-06.00	81					0 986 486 548	22,2	
2.4, quattro	08.97-09.01	120/121				0 986 486 548	22,2		
2.5 TDI, TDI quattro	11.97-09.01	110					0 986 486 548	22,2	
2.6	11.94-03.97	102/110	Fg.-Nr. →8D..V..180 000				0 986 486 551	22,2	
2.6 quattro	03.97-07.98	102/110	Fg.-Nr. 8D..V..180 001→				0 986 486 548	22,2	
2.8	03.96-03.97	142	Fg.-Nr. →8D..V..180 000				0 986 486 551	22,2	
2.8 quattro	03.97-07.98	142	Fg.-Nr. 8D..V..180 001→				0 986 486 548	22,2	
	08.97-09.01	142					0 986 486 548	22,2	
	03.99-09.01	140					0 986 486 548	22,2	
 1.6	07.96-10.96	74	Fg.-Nr. 8D..V..000 001→				0 265 216 413 ^B		
							0 265 220 440 ^E		
	10.96-06.97	74	Fg.-Nr. →8D..V..300 000				0 265 220 440 ^E		
							0 265 220 446 ^F		
	10.96-07.97	74					0 265 216 413 ^B		
	06.97-07.99	74	Fg.-Nr. 8D..V..300 001→	CS2			0 265 220 407 ^E		
	07.97-07.99	74	Fg.-Nr. 8D..V..300 001→	CS2			0 265 220 413 ^F		
	08.97-10.00	74					0 265 202 403 ^M		
					CS2		0 265 216 564 ^B		
	08.98-10.00	74			CS2		0 265 220 407 ^E		
							0 265 220 413 ^F		
	06.00-09.01	75					0 265 202 403 ^M		
					CS2		0 265 216 564 ^B		
							0 265 220 407 ^E		
							0 265 220 413 ^F		
1.8	11.94-06.97	92	Fg.-Nr. →8D..V..300 000				0 265 220 446 ^F		
	07.95-06.97	85	Fg.-Nr. →8D..V..300 000				0 265 220 446 ^F		
	07.96-06.97	85	Fg.-Nr. 8D..V..000 001→8D..V..300 000				0 265 220 440 ^E		
		92	Fg.-Nr. 8D..V..000 001→8D..V..300 000				0 265 220 440 ^E		
	07.96-12.98	85	Fg.-Nr. 8D..V..000 001→				0 265 216 413 ^B		
	07.96-04.99	92	Fg.-Nr. 8D..V..000 001→				0 265 216 413 ^B		
	06.97-12.98	85	Fg.-Nr. 8D..V..300 001→	CS2			0 265 220 407 ^E		
	06.97-04.99	92	Fg.-Nr. 8D..V..300 001→	CS2			0 265 220 407 ^E		
	07.97-12.98	85	Fg.-Nr. 8D..V..300 001→	CS2			0 265 220 413 ^F		
	07.97-04.99	92	Fg.-Nr. 8D..V..300 001→	CS2			0 265 220 413 ^F		
	08.97-12.98	85					0 265 202 403 ^M		
					CS2		0 265 216 564 ^B		
	08.97-07.99	92					0 265 202 403 ^M		
					CS2		0 265 216 564 ^B		
	08.98-07.99	92			CS2		0 265 220 407 ^E		
							0 265 220 413 ^F		
	06.00-09.01	92					0 265 202 403 ^M		
					CS2		0 265 216 564 ^B		
						0 265 220 407 ^E			
						0 265 220 413 ^F			



		S							
◀ AUDI A4 Avant [8D5; B5]									
1.8 quattro	05.95-07.96	92	Fg.-Nr. 8D..S..105 001→8D..T..400 000				0 265 218 022 ^J		
	07.95-07.96	85	Fg.-Nr. →8D..T..400 000				0 265 218 022 ^J		
	07.96-05.97	85	Fg.-Nr. 8D..V..000 001→8D..V..240 000				0 265 220 443 ^E		
		92	Fg.-Nr. 8D..V..000 001→8D..V..240 000				0 265 220 443 ^E		
	05.97-04.99	92	Fg.-Nr. 8D..V..240 001→	CS2			0 265 220 410 ^E		
	05.97-09.01	85	Fg.-Nr. 8D..V..240 001→	CS2			0 265 220 410 ^E		
	06.97-09.01	85					0 265 202 403 ^M		
		92					0 265 202 403 ^M		
	08.98-09.01	92		CS2			0 265 220 410 ^E		
	1.8 T	10.95-06.97	110	Fg.-Nr. →8D..V..300 000				0 265 220 446 ^F	
07.96-06.97		110	Fg.-Nr. 8D..V..000 001→8D..V..300 000				0 265 220 440 ^E		
07.96-07.98		110	Fg.-Nr. 8D..V..000 001→				0 265 216 413 ^B		
06.97-07.98		110	Fg.-Nr. 8D..V..300 001→	CS2			0 265 220 407 ^E		
07.97-07.98		110	Fg.-Nr. 8D..V..300 001→	CS2			0 265 220 413 ^F		
08.97-09.01		110					0 265 202 403 ^M		
					CS2		0 265 216 564 ^B		
		132			CS2		0 265 216 564 ^B		
							0 265 220 407 ^E		
							0 265 220 413 ^F		
	08.98-09.01	110		CS2		0 265 220 407 ^E			
						0 265 220 413 ^F			
1.8 T quattro	02.96-07.96	110	Fg.-Nr. →8D..T..400 000				0 265 218 022 ^J		
	07.96-05.97	110	Fg.-Nr. 8D..V..000 001→8D..V..240 000				0 265 220 443 ^E		
	05.97-12.98	110	Fg.-Nr. 8D..V..240 001→	CS2			0 265 220 410 ^E		
	06.97-12.98	110					0 265 202 403 ^M		
	08.97-09.01	132			CS2		0 265 220 410 ^E		
	08.98-12.98	110					0 265 202 403 ^M		
					CS2		0 265 220 410 ^E		
	02.99-09.01	110					0 265 202 403 ^M		
					CS2		0 265 220 410 ^E		
		EDS 05.00-09.01	125			CS2		0 265 220 410 ^E	
	MFD 05.00-09.01	125					0 265 202 403 ^M		
1.8 T, T quattro	08.97-09.01	132					0 265 202 403 ^M		
1.9 TDI	02.96-06.97	81	Fg.-Nr. →8D..V..300 000				0 265 220 446 ^F		
	07.96-06.97	81	Fg.-Nr. 8D..V..000 001→8D..V..300 000				0 265 220 440 ^E		
	07.96-12.98	81	Fg.-Nr. 8D..V..000 001→				0 265 216 413 ^B		
	08.96-06.97	66	Fg.-Nr. →8D..V..300 000				0 265 220 440 ^E		
							0 265 220 446 ^F		
	08.96-07.97	66					0 265 216 413 ^B		
	04.97-09.01	66			CS2		0 265 220 407 ^E		
	06.97-12.98	81	Fg.-Nr. 8D..V..300 001→	CS2			0 265 220 407 ^E		
	07.97-12.98	81	Fg.-Nr. 8D..V..300 001→	CS2			0 265 220 413 ^F		
	07.97-09.01	66	Fg.-Nr. 8D..V..300 001→	CS2			0 265 220 413 ^F		
	08.97-12.98	81					0 265 202 403 ^M		
					CS2		0 265 216 564 ^B		
	08.97-09.01	66					0 265 202 403 ^M		
					CS2		0 265 216 564 ^B		
	08.98-09.01	85			CS2		0 265 216 564 ^B		
							0 265 220 407 ^E		
							0 265 220 413 ^F		
		08.99-06.00	81				0 265 202 403 ^M		
					CS2		0 265 216 564 ^B		
						0 265 220 407 ^E			
						0 265 220 413 ^F			
1.9 TDI quattro	07.96-05.97	81	Fg.-Nr. →8D..V..240 000				0 265 220 443 ^E		
	05.97-07.99	81	Fg.-Nr. 8D..V..240 001→	CS2			0 265 220 410 ^E		
	06.97-01.00	81					0 265 202 403 ^M		
	12.98-12.98	85			CS2		0 265 220 410 ^E		
	08.99-01.00	81			CS2		0 265 220 410 ^E		
	01.00-09.01	85			CS2		0 265 220 410 ^E		
1.9 TDI, TDI quattro	08.98-09.01	85					0 265 202 403 ^M		

















		S							
2.4		08.97-09.01	120/121			CS2	0 265 216 564 ^B		
							0 265 220 407 ^E		
							0 265 220 413 ^F		
2.4, quattro		08.97-09.01	120/121				0 265 202 403 ^M		
2.4 quattro		08.97-09.01	120/121			CS2	0 265 220 410 ^E		
2.5 TDI		11.97-09.01	110			CS2	0 265 216 564 ^B		
2.5 TDI quattro		11.97-06.00	110			CS2	0 265 220 410 ^E		
2.5 TDI		11.97-09.01	110				0 265 202 403 ^M		
2.5 TDI quattro		01.99-09.01	110	Fg.-Nr. 8D..X..199 001→		CS2	0 265 220 527 ^F		
2.6		11.94-06.97	110	Fg.-Nr. →8D..V..300 000			0 265 220 446 ^F		
		01.96-07.97	102				0 265 202 403 ^M		
		07.96-06.97	102	Fg.-Nr. 8D..V..000 001→8D..V..300 000			0 265 220 440 ^E		
			110	Fg.-Nr. 8D..V..000 001→8D..V..300 000			0 265 220 440 ^E		
		07.96-07.97	102	Fg.-Nr. 8D..V..000 001→			0 265 216 413 ^B		
		07.96-07.98	110	Fg.-Nr. 8D..V..000 001→			0 265 216 413 ^B		
		06.97-07.97	102	Fg.-Nr. 8D..V..300 001→		CS2	0 265 220 407 ^E		
		06.97-07.98	110	Fg.-Nr. 8D..V..300 001→		CS2	0 265 220 407 ^E		
		07.97-07.98	110	Fg.-Nr. 8D..V..300 001→		CS2	0 265 220 413 ^F		
		08.97-07.98	110				0 265 202 403 ^M		
						CS2	0 265 216 564 ^B		
2.6 quattro		05.95-07.96	110	Fg.-Nr. 8D..S..105 001→8D..T..400 000			0 265 218 022 ^J		
		01.96-07.96	102	Fg.-Nr. →8D..T..400 000			0 265 218 022 ^J		
		07.96-05.97	102	Fg.-Nr. 8D..V..000 001→8D..V..240 000			0 265 220 443 ^E		
			110	Fg.-Nr. 8D..V..000 001→8D..V..240 000			0 265 220 443 ^E		
		05.97-07.97	102	Fg.-Nr. 8D..V..240 001→		CS2	0 265 220 410 ^E		
		05.97-07.98	110	Fg.-Nr. 8D..V..240 001→		CS2	0 265 220 410 ^E		
		06.97-07.97	102				0 265 202 403 ^M		
		06.97-07.98	110				0 265 202 403 ^M		
2.8		03.96-06.97	142	Fg.-Nr. →8D..V..300 000			0 265 220 446 ^F		
		07.96-06.97	142	Fg.-Nr. 8D..V..000 001→8D..V..300 000			0 265 220 440 ^E		
		07.96-07.98	142	Fg.-Nr. 8D..V..000 001→			0 265 216 413 ^B		
		06.97-07.98	142	Fg.-Nr. 8D..V..300 001→		CS2	0 265 220 407 ^E		
		07.97-07.98	142	Fg.-Nr. 8D..V..300 001→		CS2	0 265 220 413 ^F		
		08.97-07.98	142	Fg.-Nr. →8D..W..300 000			0 265 220 440 ^E		
							0 265 220 446 ^F		
		08.97-07.99	142				0 265 202 403 ^M		
						CS2	0 265 216 564 ^B		
							0 265 220 407 ^E		
							0 265 220 413 ^F		
		08.98-08.99	142	Fg.-Nr. 8D..X..000 001→		CS2	0 265 220 407 ^E		
		03.99-09.01	140			CS2	0 265 216 564 ^B		
							0 265 220 407 ^E		
							0 265 220 413 ^F		
2.8, quattro		03.99-09.01	140				0 265 202 403 ^M		
2.8 quattro		03.96-07.96	142	Fg.-Nr. →8D..T..400 000			0 265 218 022 ^J		
		07.96-05.97	142	Fg.-Nr. 8D..V..000 001→8D..V..240 000			0 265 220 443 ^E		
		05.97-07.98	142	Fg.-Nr. 8D..V..240 001→		CS2	0 265 220 410 ^E		
		06.97-09.01	142				0 265 202 403 ^M		
		08.97-09.01	142			CS2	0 265 220 410 ^E		
		09.99-09.01	140			CS2	0 265 220 410 ^E		
		EDS 08.99-09.01	142			CS2	0 265 220 410 ^E		
		MFD 08.99-09.01	142				0 265 202 403 ^M		
1.6		11.94-06.96	74	Fg.-Nr. →8D..T..300 000			0 265 108 005 ^H		
							0 265 109 002 ^K		
		01.99-10.00	74	Fg.-Nr. 8D..X..200 001→			0 265 109 463 ^M		
		06.00-09.01	75				0 265 109 463 ^M		
1.8		11.94-06.96	92	Fg.-Nr. →8D..T..300 000			0 265 108 005 ^H		
							0 265 109 002 ^K		
		07.95-06.96	85	Fg.-Nr. →8D..T..300 000			0 265 108 005 ^H		
							0 265 109 002 ^K		
		07.95-12.98	85			FMP	0 265 109 463 ^M		



		S							
<div style="display: flex; align-items: center;"> ◀ AUDI A4 Avant [8D5; B5] </div>									
1.8	01.99-07.99	92	Fg.-Nr. 8D..X..200 001→			0 265 109 463 ^M			
	04.99-07.99	92				0 265 109 463 ^M			
	06.00-09.01	92				0 265 109 463 ^M			
1.8 quattro	11.94-04.95	92	Fg.-Nr. →8D..S..105 000			0 265 109 026 ^K			
	11.94-04.99	92			FMP,GRG	0 265 109 426 ^M			
	04.95-07.96	92	Fg.-Nr. 8D..S..105 001→8D..T..400 000			0 265 109 031 ^J			
	07.95-07.96	85	Fg.-Nr. →8D..T..400 000			0 265 109 031 ^J			
	07.95-06.99	85	Fg.-Nr. →8D..X..400 000			FMP,GRG	0 265 109 426 ^M		
	08.98-06.99	92	Fg.-Nr. →8D..X..400 000			FMP,GRG	0 265 109 426 ^M		
	07.99-09.01	85	Fg.-Nr. 8D..Y..000 001→			FMP,GRG	0 265 109 462 ^M		
		92	Fg.-Nr. 8D..Y..000 001→			FMP,GRG	0 265 109 462 ^M		
1.8 T	10.95-06.96	110	Fg.-Nr. →8D..T..300 000			0 265 108 005 ^H			
						0 265 109 002 ^K			
	10.95-07.98	110			FMP	0 265 109 463 ^M			
	01.99-09.01	110	Fg.-Nr. 8D..X..200 001→			0 265 109 463 ^M			
		132	Fg.-Nr. 8D..X..200 001→			0 265 109 463 ^M			
	05.99-07.99	110				0 265 109 463 ^M			
	06.00-09.01	110				0 265 109 463 ^M			
1.8 T quattro	02.96-07.96	110	Fg.-Nr. →8D..T..400 000			0 265 109 031 ^J			
	02.96-12.98	110			FMP,GRG	0 265 109 426 ^M			
	08.97-06.99	132	Fg.-Nr. →8D..X..400 000			FMP,GRG	0 265 109 426 ^M		
	02.99-06.99	110	Fg.-Nr. →8D..X..400 000			FMP,GRG	0 265 109 426 ^M		
	07.99-09.01	110				FMP,GRG	0 265 109 462 ^M		
		132	Fg.-Nr. 8D..Y..000 001→			FMP,GRG	0 265 109 462 ^M		
1.9 TDI	01.95-06.96	66	Fg.-Nr. →8D..T..300 000			0 265 108 005 ^H			
						0 265 109 002 ^K			
	02.96-06.96	81	Fg.-Nr. →8D..T..300 000			0 265 108 005 ^H			
						0 265 109 002 ^K			
	02.96-12.98	81			FMP	0 265 109 463 ^M			
	08.96-09.01	66			FMP	0 265 109 463 ^M			
	01.99-09.01	85	Fg.-Nr. 8D..X..200 001→			0 265 109 463 ^M			
	08.99-06.00	81				0 265 109 463 ^M			
	1.9 TDI quattro	07.96-07.99	81			FMP,GRG	0 265 109 426 ^M		
		12.98-12.98	85			FMP,GRG	0 265 109 426 ^M		
08.99-01.00		81			FMP,GRG	0 265 109 462 ^M			
01.00-09.01		85			FMP,GRG	0 265 109 462 ^M			
2.4	08.97-07.98	121			FMP	0 265 109 463 ^M			
	01.99-06.00	120	Fg.-Nr. 8D..X..200 001→			0 265 109 463 ^M			
	01.99-09.01	121	Fg.-Nr. 8D..X..200 001→			0 265 109 463 ^M			
	06.00-09.01	120				0 265 109 463 ^M			
	2.4 quattro	08.97-07.98	120			FMP,GRG	0 265 109 426 ^M		
08.97-12.98		121			FMP,GRG	0 265 109 426 ^M			
08.98-06.99		120	Fg.-Nr. →8D..X..400 000			FMP,GRG	0 265 109 426 ^M		
		121	Fg.-Nr. →8D..X..400 000			FMP,GRG	0 265 109 426 ^M		
07.99-06.00		120	Fg.-Nr. 8D..Y..000 001→			FMP,GRG	0 265 109 462 ^M		
07.99-09.01		121	Fg.-Nr. 8D..Y..000 001→			FMP,GRG	0 265 109 462 ^M		
2.5 TDI	01.99-09.01	110	Fg.-Nr. 8D..X..200 001→			0 265 109 463 ^M			
2.5 TDI quattro	11.97-06.99	110	Fg.-Nr. →8D..X..400 000			FMP,GRG	0 265 109 426 ^M		
	07.99-06.00	110	Fg.-Nr. 8D..Y..000 001→			FMP,GRG	0 265 109 462 ^M		
2.6	11.94-06.96	110	Fg.-Nr. →8D..T..300 000			0 265 108 005 ^H			
						0 265 109 002 ^K			
	11.94-07.98	110			FMP	0 265 109 463 ^M			
	01.96-06.96	102	Fg.-Nr. →8D..T..300 000			0 265 108 005 ^H			
						0 265 109 002 ^K			
2.6 quattro	11.94-04.95	110	Fg.-Nr. →8D..S..105 000			0 265 109 026 ^K			
	11.94-07.98	110			FMP,GRG	0 265 109 426 ^M			
	04.95-07.96	110	Fg.-Nr. 8D..S..105 001→8D..T..400 000			0 265 109 031 ^J			
	01.96-07.96	102	Fg.-Nr. →8D..T..400 000			0 265 109 031 ^J			
	2.8	03.96-06.96	142	Fg.-Nr. →8D..T..300 000			0 265 108 005 ^H		
						0 265 109 002 ^K			
	03.96-07.98	142			FMP	0 265 109 463 ^M			
	01.99-07.99	142	Fg.-Nr. 8D..X..200 001→			0 265 109 463 ^M			
	03.99-09.01	140				0 265 109 463 ^M			













		S							
2.8 quattro		03.96-07.96	142	Fg.-Nr. →8D..T..400 000			0 265 109 031 ^J		
		03.96-07.98	142		FMP,GRG		0 265 109 426 ^M		
		08.98-06.99	142	Fg.-Nr. →8D..X..400 000	FMP,GRG		0 265 109 426 ^M		
		07.99-06.00	142	Fg.-Nr. 8D..Y..000 001→	FMP,GRG		0 265 109 462 ^M		
		09.99-09.01	140		FMP,GRG		0 265 109 462 ^M		
		06.00-09.01	142		FMP,GRG		0 265 109 462 ^M		
	1.6	11.94-09.01	74/75				0 265 005 162 ^S		
	1.8, quattro, T, T quattro	11.94-09.01	85/92/110/132				0 265 005 162 ^S		
	1.9 TDI, TDI quattro	01.95-09.01	66/81/85				0 265 005 162 ^S		
	2.4, quattro	08.97-09.01	120/121				0 265 005 162 ^S		
	2.5 TDI, TDI quattro	11.97-09.01	110				0 265 005 162 ^S		
	2.6, quattro	11.94-07.98	102/110				0 265 005 162 ^S		
	2.8, quattro	03.96-09.01	140/142				0 265 005 162 ^S		
	1.6	11.94-09.01	74/75				0 265 005 207		
							0 265 005 214		
	1.8, quattro, T, T quattro	11.94-09.01	85/92/110/132				0 265 005 207		
							0 265 005 214		
	1.9 TDI	01.95-09.01	66/81/85				0 265 005 207		
	1.9 TDI quattro						0 265 005 214		
	2.4	08.97-09.01	120/121				0 265 005 207		
	2.4 quattro						0 265 005 214		
	2.5 TDI	11.97-09.01	110				0 265 005 207		
	2.5 TDI quattro						0 265 005 214		
	2.6	11.94-07.98	102/110				0 265 005 214		
	2.6, quattro	11.94-07.98	102/110				0 265 005 207		
	2.8	03.96-09.01	140/142				0 265 005 207		
	2.8 quattro						0 265 005 214		
	1.6	06.00-09.01	75				0 265 005 303		
	1.8, quattro, T, T quattro	07.95-09.01	85/92/110/132				0 265 005 303		
	1.9 TDI, TDI quattro	08.98-09.01	85				0 265 005 303		
	2.4, quattro	08.98-09.01	120/121				0 265 005 303		
	2.5 TDI	08.98-09.01	110				0 265 005 303		
	2.8, quattro	03.99-09.01	140/142				0 265 005 303		
A4 Avant [8ED; B7]									
									
	1.6	11.04-06.08	75		JBH	GIR	0 986 481 046	25,4	
	1.8 T, T quattro	11.04-06.08	120		JBH	GIR	0 986 481 046	25,4	
	1.9 TDI	11.04-06.08	85		JBH	GIR	0 986 481 046	25,4	
	2.0, TDI, TDI quattro, TFSI, TFSI quattro	11.04-06.08	89/93/96/100/103/120/125/147/162		JBH	GIR	0 986 481 046	25,4	
	2.5 TDI	11.04-05.06	120		JBH	GIR	0 986 481 046	25,4	
	2.7 TDI	11.05-06.08	120/132		JBH	GIR	0 986 481 046	25,4	
	3.0, quattro, TDI quattro	11.04-06.08	150/160/171		JBH	GIR	0 986 481 046	25,4	
	3.2 FSI, FSI quattro	01.05-06.08	188		JBH	GIR	0 986 481 046	25,4	
	1.6	11.04-06.08	75		LLE		0 986 486 062	19,05	
	1.8 T, T quattro	11.04-06.08	120		LLE		0 986 486 062	19,05	
	1.9 TDI	11.04-06.08	85		LLE		0 986 486 062	19,05	
	2.0, TDI, TDI quattro, TFSI	11.04-06.08	89/93/96/100/103/120/125		LLE		0 986 486 062	19,05	
	2.0 TFSI	11.04-06.08	147		LLE		0 986 486 062	19,05	
		01.05-06.08	147				0 986 486 062	19,05	
	2.0 TFSI quattro	11.04-06.08	147		LLE		0 986 486 062	19,05	
	2.0 TFSI, TFSI quattro	06.05-06.08	162		LLE		0 986 486 062	19,05	
	2.5 TDI	11.04-05.06	120		LLE		0 986 486 062	19,05	
	2.7 TDI	11.05-06.08	120/132		LLE		0 986 486 062	19,05	
	3.0, quattro, TDI quattro	11.04-06.08	150/160/171		LLE		0 986 486 062	19,05	
	3.2 FSI, FSI quattro	01.05-06.08	188		LLE		0 986 486 062	19,05	





◀ AUDI A4 Avant [8ED; B7]

	1.6	11.04-06.08	75		0 986 486 583	22,2
	1.8 T, T quattro	11.04-06.08	120		0 986 486 583	22,2
	1.9 TDI	01.06-06.08	85		0 986 486 583	22,2
	2.0, TDI, TDI quattro, TFSI, TFSI quattro	11.04-06.08	89/93/96/100/103/120/125/147/162		0 986 486 583	22,2
	2.5 TDI	11.04-05.06	120		0 986 486 583	22,2
	2.7 TDI	11.05-06.08	120/132		0 986 486 583	22,2
	3.0, quattro, TDI quattro	11.04-06.08	150/160/171		0 986 486 583	22,2
	3.2 FSI, FSI quattro	01.05-06.08	188		0 986 486 583	22,2
	1.6	11.04-05.05	75	Fg.-Nr. →8E..5..600 000	0 265 234 332 ^T	
		06.05-06.08	75	Fg.-Nr. 8E..6..000 001→	0 265 234 338 ^T	
	1.8 T	11.04-05.05	120	Fg.-Nr. →8E..5..600 000	0 265 234 332 ^T	
		06.05-06.08	120	Fg.-Nr. 8E..6..000 001→	0 265 234 338 ^T	
	1.8 T quattro	11.04-05.05	120	Fg.-Nr. →8E..5..600 000	0 265 234 329 ^T	
		06.05-06.08	120	Fg.-Nr. 8E..6..000 001→	0 265 234 335 ^T	
	1.9 TDI	11.04-05.05	85	Fg.-Nr. →8E..5..600 000	0 265 234 332 ^T	
		06.05-12.05	85	Fg.-Nr. 8E..6..000 001→	0 265 234 338 ^T	
		01.06-06.08	85		0 265 234 338 ^T	
	2.0	11.04-05.05	96	Fg.-Nr. →8E..5..600 000	0 265 234 332 ^T	
		06.05-06.08	96	Fg.-Nr. 8E..6..000 001→	0 265 234 338 ^T	
	2.0 TDI	11.04-05.05	100	Fg.-Nr. →8E..5..600 000	0 265 234 332 ^T	
		11.04-11.05	103		0 265 234 332 ^T	
		06.05-10.05	100	Fg.-Nr. 8E..6..000 001→	0 265 234 338 ^T	
		06.05-06.08	103	Fg.-Nr. 8E..6..000 001→	0 265 234 338 ^T	
		10.05-06.08	103		0 265 234 338 ^T	
		11.05-11.06	89/93		0 265 234 338 ^T	
		11.05-06.08	100		0 265 234 338 ^T	
	2.0 TDI quattro	01.06-06.08	103		0 265 234 335 ^T	
		06.06-06.08	120/125		0 265 234 335 ^T	
	2.0 TDI, TFSI	06.06-06.08	120/125		0 265 234 338 ^T	
	2.0 TFSI	11.04-05.05	147	Fg.-Nr. →8E..5..600 000	0 265 234 332 ^T	
		06.05-06.08	147	Fg.-Nr. 8E..6..000 001→	0 265 234 338 ^T	
			162		0 265 234 338 ^T	
	09.05-06.08	147		0 265 234 338 ^T		
	2.0 TFSI quattro	11.04-05.05	147	Fg.-Nr. →8E..5..600 000	0 265 234 329 ^T	
		06.05-08.05	147	Fg.-Nr. 8E..6..000 001→	0 265 234 335 ^T	
		06.05-06.08	162		0 265 234 335 ^T	
		09.05-06.08	147		0 265 234 335 ^T	
	2.5 TDI	11.04-05.05	120	Fg.-Nr. →8E..5..600 000	0 265 234 332 ^T	
		06.05-05.06	120	Fg.-Nr. 8E..6..000 001→	0 265 234 338 ^T	
	2.7 TDI	11.05-06.08	120/132		0 265 234 338 ^T	
	3.0	11.04-05.05	160	Fg.-Nr. →8E..5..600 000	0 265 234 332 ^T	
		06.05-05.06	160	Fg.-Nr. 8E..6..000 001→	0 265 234 338 ^T	
	3.0 quattro	11.04-05.05	160	Fg.-Nr. →8E..5..600 000	0 265 234 329 ^T	
		06.05-05.06	160	Fg.-Nr. 8E..6..000 001→	0 265 234 335 ^T	
	3.0 TDI quattro	01.05-05.05	150	Fg.-Nr. →8E..5..600 000	0 265 234 329 ^T	
		06.05-05.06	150	Fg.-Nr. 8E..6..000 001→	0 265 234 335 ^T	
		01.06-06.08	171		0 265 234 335 ^T	
	3.2 FSI	01.05-05.05	188	Fg.-Nr. →8E..5..600 000	0 265 234 332 ^T	
06.05-06.08		188	Fg.-Nr. 8E..6..000 001→	0 265 234 338 ^T		
3.2 FSI quattro	01.05-05.05	188	Fg.-Nr. →8E..5..600 000	0 265 234 329 ^T		
	06.05-06.08	188	Fg.-Nr. 8E..6..000 001→	0 265 234 335 ^T		
	1.6	11.04-05.05	75	Fg.-Nr. →8E..5..600 000	0 265 005 692	
		06.05-06.08	75	Fg.-Nr. 8E..6..000 001→, PR-Code G0C, PR-Code G0G, PR-Code G0K	0 265 005 619	
				Fg.-Nr. 8E..6..000 001→, PR-Code G0Z	0 265 005 621	
	1.8 T	11.04-05.05	120	Fg.-Nr. →8E..5..600 000	0 265 005 692	
	1.8 T quattro	06.05-06.08	120	Fg.-Nr. 8E..6..000 001→, PR-Code G0C, PR-Code G0G, PR-Code G0K	0 265 005 619	
			Fg.-Nr. 8E..6..000 001→, PR-Code G0Z	0 265 005 621		

		S							
1.9 TDI	11.04-05.05	85			Fg.-Nr. →8E..5..600 000		0 265 005 692		
	06.05-12.05	85			Fg.-Nr. 8E..6..000 001→, PR-Code G0C, PR-Code G0G, PR-Code G0K		0 265 005 619		
					Fg.-Nr. 8E..6..000 001→, PR-Code G0Z		0 265 005 621		
	01.06-06.08	85			PR-Code G0C, PR-Code G0G, PR-Code G0K		0 265 005 619		
					PR-Code G0Z		0 265 005 621		
2.0	11.04-05.05	96			Fg.-Nr. →8E..5..600 000		0 265 005 692		
	06.05-06.08	96			Fg.-Nr. 8E..6..000 001→, PR-Code G0C, PR-Code G0G, PR-Code G0K		0 265 005 619		
					Fg.-Nr. 8E..6..000 001→, PR-Code G0Z		0 265 005 621		
2.0 TDI	11.04-05.05	100			Fg.-Nr. →8E..5..600 000		0 265 005 692		
	11.04-11.05	103					0 265 005 692		
	06.05-10.05	100			Fg.-Nr. 8E..6..000 001→, PR-Code G0C, PR-Code G0G, PR-Code G0K		0 265 005 619		
					Fg.-Nr. 8E..6..000 001→, PR-Code G0Z		0 265 005 621		
	06.05-06.08	103			PR-Code G0C, PR-Code G0G, PR-Code G0K		0 265 005 619		
					Fg.-Nr. 8E..6..000 001→, PR-Code G0Z		0 265 005 621		
	10.05-06.08	103			PR-Code G0C, PR-Code G0G, PR-Code G0K		0 265 005 619		
					PR-Code G0Z		0 265 005 621		
	11.05-11.06	89/93			PR-Code G0C, PR-Code G0G, PR-Code G0K		0 265 005 619		
				PR-Code G0Z		0 265 005 621			
	11.05-06.08	100			PR-Code G0C, PR-Code G0G, PR-Code G0K		0 265 005 619		
					PR-Code G0Z		0 265 005 621		
2.0 TDI quattro	01.06-06.08	103			PR-Code G0C, PR-Code G0G, PR-Code G0K		0 265 005 619		
					PR-Code G0Z		0 265 005 621		
2.0 TDI, TDI quattro, TFSI	06.06-06.08	120/125			PR-Code G0C, PR-Code G0G, PR-Code G0K		0 265 005 619		
					PR-Code G0Z		0 265 005 621		
2.0 TFSI	11.04-05.05	147			Fg.-Nr. →8E..5..600 000		0 265 005 692		
2.0 TFSI quattro	06.05-06.08	147			Fg.-Nr. 8E..6..000 001→, PR-Code G0C, PR-Code G0G, PR-Code G0K		0 265 005 619		
					Fg.-Nr. 8E..6..000 001→, PR-Code G0Z		0 265 005 621		
		162			PR-Code G0C, PR-Code G0G, PR-Code G0K		0 265 005 619		
					PR-Code G0Z		0 265 005 621		
	09.05-06.08	147			PR-Code G0C, PR-Code G0G, PR-Code G0K		0 265 005 619		
					PR-Code G0Z		0 265 005 621		
2.5 TDI	11.04-05.05	120			Fg.-Nr. →8E..5..600 000		0 265 005 692		
	06.05-05.06	120			Fg.-Nr. 8E..6..000 001→, PR-Code G0C, PR-Code G0G, PR-Code G0K		0 265 005 619		
					Fg.-Nr. 8E..6..000 001→, PR-Code G0Z		0 265 005 621		
2.7 TDI	11.05-06.08	120/132			PR-Code G0C, PR-Code G0G, PR-Code G0K		0 265 005 619		
					PR-Code G0Z		0 265 005 621		
3.0	11.04-05.05	150/160			Fg.-Nr. →8E..5..600 000		0 265 005 692		
	06.05-05.06	150/160			Fg.-Nr. 8E..6..000 001→, PR-Code G0C, PR-Code G0G, PR-Code G0K		0 265 005 619		
3.0 quattro					Fg.-Nr. 8E..6..000 001→, PR-Code G0Z		0 265 005 621		
3.0 TDI quattro	01.06-06.08	171			PR-Code G0C, PR-Code G0G, PR-Code G0K		0 265 005 619		
					PR-Code G0Z		0 265 005 621		
3.2 FSI	01.05-05.05	188			Fg.-Nr. →8E..5..600 000		0 265 005 692		
3.2 FSI quattro	06.05-06.08	188			Fg.-Nr. 8E..6..000 001→, PR-Code G0C, PR-Code G0G, PR-Code G0K		0 265 005 619		
					Fg.-Nr. 8E..6..000 001→, PR-Code G0Z		0 265 005 621		
A4 Avant [8E5; B6]									
									
1.6		09.01-12.04	75			JBH	GIR	0 986 481 046	25,4
1.8 T, T quattro		09.01-12.04	110/120/125/140			JBH	GIR	0 986 481 046	25,4
1.9 TDI, TDI quattro		09.01-12.04	74/85/96			JBH	GIR	0 986 481 046	25,4
2.0, FSI		09.01-12.04	96/110			JBH	GIR	0 986 481 046	25,4
2.4		09.01-12.04	120/125			JBH	GIR	0 986 481 046	25,4
2.5 TDI, TDI quattro		09.01-12.04	114/120/132			JBH	GIR	0 986 481 046	25,4
3.0, quattro		09.01-12.04	160/162			JBH	GIR	0 986 481 046	25,4





◀ AUDI A4 Avant [8E5; B6]

	1.6	09.01-12.04	75		LLE	0 986 486 062	19,05
	1.8 T, T quattro	09.01-12.04	110/120/125/140		LLE	0 986 486 062	19,05
	1.9 TDI, TDI quattro	09.01-12.04	74/85/96		LLE	0 986 486 062	19,05
	2.0, FSI	09.01-12.04	96/110		LLE	0 986 486 062	19,05
	2.4	09.01-12.04	120/125		LLE	0 986 486 062	19,05
	2.5 TDI, TDI quattro	09.01-12.04	114/120/132		LLE	0 986 486 062	19,05
	3.0, quattro	09.01-12.04	160/162		LLE	0 986 486 062	19,05
	1.6	09.01-04.04	75	Fg.-Nr. →8E..4..270 000		0 986 486 548	22,2
		05.04-12.04	75	Fg.-Nr. 8E..4..270 000→		0 986 486 583	22,2
	1.8 T quattro	09.01-12.04	125			0 986 486 548	22,2
	1.8 T	09.01-06.02	110			0 986 486 548	22,2
	1.8 T quattro	07.02-04.04	120	Fg.-Nr. →8E..4..270 000		0 986 486 548	22,2
		11.02-04.04	140	Fg.-Nr. →8E..4..270 000		0 986 486 548	22,2
		05.04-12.04	120	Fg.-Nr. 8E..4..270 000→		0 986 486 583	22,2
			140	Fg.-Nr. 8E..4..270 000→		0 986 486 583	22,2
	1.9 TDI	09.01-05.04	74			0 986 486 548	22,2
	1.9 TDI, TDI quattro	09.01-12.04	96			0 986 486 583	22,2
	2.0	09.01-04.04	96/110	Fg.-Nr. →8E..4..270 000		0 986 486 548	22,2
	2.0 FSI	05.04-12.04	96/110	Fg.-Nr. 8E..4..270 000→		0 986 486 583	22,2
	2.4	09.01-12.04	120/125			0 986 486 548	22,2
	2.5 TDI	09.01-06.02	114			0 986 486 548	22,2
	2.5 TDI	09.01-05.03	120/132			0 986 486 548	22,2
	2.5 TDI quattro	11.02-04.04	120/132	Fg.-Nr. →8E..4..270 000		0 986 486 548	22,2
		05.04-12.04	120/132	Fg.-Nr. 8E..4..270 000→		0 986 486 583	22,2
	3.0	09.01-04.04	162	Fg.-Nr. →8E..4..270 000		0 986 486 548	22,2
	3.0	09.01-04.04	160	Fg.-Nr. →8E..4..270 000		0 986 486 548	22,2
	3.0 quattro	05.04-12.04	160	Fg.-Nr. 8E..4..270 000→		0 986 486 583	22,2
		162	Fg.-Nr. 8E..4..270 000→		0 986 486 583	22,2	
3.0 quattro	09.01-05.04	162			0 986 486 548	22,2	
	1.6	09.01-12.04	75		CS2	0 265 225 050 ^T	
	1.8 T	09.01-12.04	110/120		CS2	0 265 225 050 ^T	
		11.02-12.04	140		CS2	0 265 225 050 ^T	
	1.8 T quattro	09.01-12.04	110/120			0 265 225 047 ^T	
			125			0 265 225 047 ^T	
		11.02-12.04	140			0 265 225 047 ^T	
	1.9 TDI	09.01-12.04	74/85		CS2	0 265 225 050 ^T	
			96		CS2	0 265 225 050 ^T	
	1.9 TDI quattro	09.01-12.04	96			0 265 225 047 ^T	
	2.0, FSI	09.01-12.04	96/110		CS2	0 265 225 050 ^T	
	2.4	09.01-12.04	120/125		CS2	0 265 225 050 ^T	
	2.5 TDI	09.01-12.04	114/120		CS2	0 265 225 050 ^T	
	2.5 TDI quattro	09.01-12.04	132			0 265 225 047 ^T	
3.0	09.01-12.04	160/162		CS2	0 265 225 050 ^T		
3.0 quattro	09.01-12.04	160/162			0 265 225 047 ^T		
	1.6	09.01-12.04	75			0 265 005 252	
	1.8 T, T quattro	09.01-12.04	110/120/125/140			0 265 005 252	
	1.9 TDI, TDI quattro	09.01-12.04	74/85/96			0 265 005 252	
	2.0, FSI	09.01-12.04	96/110			0 265 005 252	
	2.4	09.01-12.04	120/125			0 265 005 252	
	2.5 TDI, TDI quattro	09.01-12.04	114/120/132			0 265 005 252	
	3.0, quattro	09.01-12.04	160/162			0 265 005 252	
	1.6	09.01-12.04	75			0 265 005 303	
	1.8 T, T quattro	09.01-12.04	110/120/125/140			0 265 005 303	
	1.9 TDI, TDI quattro	09.01-12.04	74/85/96			0 265 005 303	
	2.0, FSI	09.01-12.04	96/110			0 265 005 303	
	2.4	09.01-12.04	120/125			0 265 005 303	
	2.5 TDI, TDI quattro	09.01-12.04	114/120/132			0 265 005 303	
	3.0, quattro	09.01-12.04	160/162			0 265 005 303	



A4 Avant [8K5; B8]

	1.8 TFSI	01.08-05.08	118	Fg.-Nr. 8K..8A011 501→, 8K..8N003 201→, PR-Code 1AT		0 265 236 086 ^T			
	2.7 TDI	06.08-11.09	120/140	PR-Code 1AT		0 265 236 086 ^T			
	3.0 TDI quattro	04.08-11.09	155/176	PR-Code 1AT		0 265 236 086 ^T			
	3.2 FSI, FSI quattro	04.08-11.09	195	PR-Code 1AT		0 265 236 086 ^T			
	1.8 TFSI	11.07-05.08	118	NAD		0 265 005 741			
		06.08-03.12	118	FDS		0 265 005 741			
				FDS		0 265 005 739			
		06.08→	88	FDS		0 265 005 741			
				FDS		0 265 005 739			
		OAD 11.07-05.08	118			0 265 005 739			
	1.8 TFSI quattro	09.08-03.12	118	FDS		0 265 005 741			
				FDS		0 265 005 739			
	2.0 TDI	04.08-03.12	120	FDS		0 265 005 741			
				FDS		0 265 005 739			
		04.08→	100	FDS		0 265 005 741			
				FDS		0 265 005 739			
		06.08-03.12	88	FDS		0 265 005 741			
				FDS		0 265 005 739			
		09.13→	120	TW		0 265 005 741			
		04.14→	100	TW		0 265 005 741			
	2.0 TDI quattro	04.14→	100	TW		0 265 005 741			
	2.0 TDI	04.08-03.12	105	FDS		0 265 005 741			
	2.0 TDI quattro			FDS		0 265 005 739			
		05.13→	110	TW		0 265 005 741			
		09.13→	140	TW		0 265 005 741			
	2.0 TDI, TDI quattro, TFSI, TFSI flexible fuel, TFSI quattro flexible fuel	04.08→	125/132	FDS		0 265 005 741			
				FDS		0 265 005 739			
	2.0 TFSI	06.08→	155	FDS		0 265 005 741			
	2.0 TFSI quattro			FDS		0 265 005 739			
		05.13→	165	TW		0 265 005 741			
	2.7 TDI	04.08-05.08	120	NAD		0 265 005 741			
			140	NAD		0 265 005 741			
		06.08-03.12	120	FDS		0 265 005 741			
				FDS		0 265 005 739			
			140	FDS		0 265 005 741			
				FDS		0 265 005 739			
		OAD 04.08-05.08	120			0 265 005 739			
			140			0 265 005 739			
	3.0 TDI quattro	04.08-05.08	176	NAD		0 265 005 741			
		04.08-03.12	176	FDS		0 265 005 741			
				FDS		0 265 005 739			
		06.08-05.10	155	FDS		0 265 005 741			
				FDS		0 265 005 739			
		OAD 04.08-05.08	176			0 265 005 739			
	3.0 TDI quattro, TFSI quattro	05.13→	180/200	TW		0 265 005 741			
	3.2 FSI	04.08-03.12	195	FDS		0 265 005 741			
	3.2 FSI quattro			FDS		0 265 005 739			

A4 Cabriolet [8HE; B7]

	1.8 T	01.06-03.09	120	JBH	GIR	0 986 481 046	25,4		
	2.0 TDI, TFSI	01.06-03.09	100/103/147	JBH	GIR	0 986 481 046	25,4		
	2.7 TDI	11.05-03.09	132	JBH	GIR	0 986 481 046	25,4		
	3.0 TDI quattro	01.06-03.09	150/171	JBH	GIR	0 986 481 046	25,4		
	3.2 FSI, FSI quattro	01.06-03.09	188	JBH	GIR	0 986 481 046	25,4		



◀ AUDI A4 Cabriolet [8HE; B7]

	1.8 T	01.06-03.09	120		LLE	0 986 486 062	19,05
	2.0 TDI	01.06-03.09	100/103		LLE	0 986 486 062	19,05
	2.0 TFSI	01.06-03.09	147		LLE	0 986 486 062	19,05
		08.06-03.09	147			0 986 486 062	19,05
	2.7 TDI	11.05-03.09	132		LLE	0 986 486 062	19,05
	3.0 TDI quattro	01.06-03.09	150/171		LLE	0 986 486 062	19,05
3.2 FSI, FSI quattro	01.06-03.09	188		LLE	0 986 486 062	19,05	
	1.8 T	01.06-03.09	120			0 986 486 583	22,2
	2.0 TDI, TFSI	01.06-03.09	100/103/147			0 986 486 583	22,2
	2.7 TDI	11.05-03.09	132			0 986 486 583	22,2
	3.0 TDI quattro	01.06-03.09	150/171			0 986 486 583	22,2
	3.2 FSI, FSI quattro	01.06-03.09	188			0 986 486 583	22,2
	1.8 T	01.06-03.09	120			0 265 234 338 ^T	
	2.0 TDI, TFSI	01.06-03.09	100/103/147			0 265 234 338 ^T	
	2.7 TDI	11.05-03.09	132			0 265 234 338 ^T	
	3.0 TDI quattro	01.06-03.09	150/171			0 265 234 335 ^T	
	3.2 FSI	01.06-03.09	188			0 265 234 338 ^T	
	3.2 FSI quattro	01.06-03.09	188			0 265 234 335 ^T	
	1.8 T	01.06-03.09	120			0 265 005 621	
	2.0 TDI, TFSI	01.06-03.09	100/103/147			0 265 005 621	
	2.7 TDI	11.05-03.09	132			0 265 005 621	
	3.0 TDI quattro	01.06-03.09	150/171			0 265 005 621	
	3.2 FSI, FSI quattro	01.06-03.09	188			0 265 005 621	
	3.0 TDI quattro	01.06-03.09	150/171			0 265 005 303	
	3.2 FSI, FSI quattro	01.06-03.09	188			0 265 005 303	

A4 Cabriolet [8H7; B6]

	1.8 T, T quattro	04.02-06.06	120/125		JBH GIR	0 986 481 046	25,4	
	2.0	05.04-12.05	96		JBH GIR	0 986 481 046	25,4	
	2.4	04.02-12.05	120/125		JBH GIR	0 986 481 046	25,4	
	2.5 TDI	08.02-12.05	120		JBH GIR	0 986 481 046	25,4	
	3.0, quattro	04.02-12.05	160/162		JBH GIR	0 986 481 046	25,4	
	4.2 quattro	02.04-12.05	253		JBH	0 986 481 006	27	
		1.8 T	10.02-06.06	125			0 986 486 062	19,05
1.8 T, T quattro		04.02-12.05	120		LLE	0 986 486 062	19,05	
2.0		05.04-12.05	96		LLE	0 986 486 062	19,05	
2.4		04.02-12.05	120/125		LLE	0 986 486 062	19,05	
2.5 TDI		08.02-12.05	120		LLE	0 986 486 062	19,05	
3.0, quattro		04.02-12.05	160/162		LLE	0 986 486 062	19,05	
4.2 quattro		02.04-12.05	253		LLE	0 986 486 062	19,05	
	1.8 T	10.02-02.04	125	Fg.-Nr. →8H..4..022 000		0 986 486 548	22,2	
		03.04-06.06	125	Fg.-Nr. 8H..4..022 001→		0 986 486 583	22,2	
	1.8 T	04.02-04.04	120	Fg.-Nr. →8E..4..270 000		0 986 486 548	22,2	
	1.8 T quattro	05.04-12.05	120	Fg.-Nr. 8E..4..270 000→		0 986 486 583	22,2	
	2.0	05.04-12.05	96			0 986 486 583	22,2	
	2.4	04.02-12.05	120/125			0 986 486 548	22,2	
		2.5 TDI	08.02-05.03	120			0 986 486 548	22,2
			06.03-04.04	120	Fg.-Nr. →8E..4..270 000		0 986 486 548	22,2
		05.04-12.05	120	Fg.-Nr. 8E..4..270 000→		0 986 486 583	22,2	
	3.0	04.02-04.04	160/162	Fg.-Nr. →8E..4..270 000		0 986 486 548	22,2	
	3.0 quattro	05.04-12.05	160/162	Fg.-Nr. 8E..4..270 000→		0 986 486 583	22,2	
4.2 quattro	02.04-12.05	253			0 986 486 583	22,2		



	1.8 T	04.02-12.05	120		CS2	0 265 225 050 ^T	
		10.02-06.06	125		CS2	0 265 225 050 ^T	
	1.8 T quattro	07.02-12.05	120			0 265 225 047 ^T	
	2.0	05.04-12.05	96		CS2	0 265 225 050 ^T	
	2.4	04.02-12.05	120/125		CS2	0 265 225 050 ^T	
	2.5 TDI	08.02-12.05	120		CS2	0 265 225 050 ^T	
	3.0	04.02-12.05	160		CS2	0 265 225 050 ^T	
			162		CS2	0 265 225 050 ^T	
	3.0 quattro	06.03-12.05	162			0 265 225 047 ^T	
	4.2 quattro	02.04-12.05	253			0 265 225 241 ^T	
	1.8 T, T quattro	04.02-12.05	120			0 265 005 252	
	2.0	05.04-12.05	96			0 265 005 252	
	2.4	04.02-12.05	120/125			0 265 005 252	
	2.5 TDI	08.02-12.05	120			0 265 005 252	
	3.0, quattro	04.02-12.05	160/162			0 265 005 252	
	1.8 T, T quattro	04.02-12.05	120			0 265 005 303	
	2.0	05.04-12.05	96			0 265 005 303	
	2.4	04.02-12.05	120/125			0 265 005 303	
	2.5 TDI	08.02-12.05	120			0 265 005 303	
	3.0, quattro	04.02-12.05	160/162			0 265 005 303	
4.2 quattro	02.04-12.05	253			0 265 005 303		

A4 Sportback [8TA]

	2.0 TDI quattro	01.12→	130		NAD	0 265 005 741	
		OAD 01.12→	130	PR-Code GP1		0 265 005 739	









A4 [8D2; B5]

	1.6	11.94-10.96	74		JBH	0 986 480 890	23,81
		10.96-12.98	74	Fg.-Nr. →8D..X..199 999	JBH	0 986 480 890	23,81
		MFD 01.99-06.00	74	Fg.-Nr. 8D..X..200 001→	JBH,LLE	0 986 480 966	25,4
					JBH,RLE	0 986 480 989	25,4
		06.00-10.00	75		JBH,LLE	0 986 480 966	25,4
					JBH,RLE	0 986 480 989	25,4
		OFD 01.99-06.00	74	Fg.-Nr. 8D..X..200 001→	JBH,LLE	0 986 480 935	25,4
		06.00-10.00	75		JBH,LLE	0 986 480 935	25,4
					JBH,LLE	0 986 480 935	25,4
					JBH,LLE	0 986 480 935	25,4
1.8	11.94-12.98	92	Fg.-Nr. →8D..X..199 999	JBH	0 986 480 890	23,81	
	04.95-12.98	85	Fg.-Nr. →8D..X..199 999	JBH	0 986 480 890	23,81	
	MFD 01.99-06.00	85	Fg.-Nr. 8D..X..200 001→	JBH,LLE	0 986 480 966	25,4	
	01.99-10.00	92	Fg.-Nr. 8D..X..200 001→	JBH,LLE	0 986 480 966	25,4	
	04.99-10.00	92		JBH,LLE	0 986 480 966	25,4	
1.8	MFD 01.99-10.00	92	Fg.-Nr. 8D..X..200 001→	JBH,RLE	0 986 480 989	25,4	
	1.8 quattro	01.99-10.01	85	Fg.-Nr. 8D..X..200 001→	JBH,RLE	0 986 480 989	25,4
		02.99-10.00	92		JBH,RLE	0 986 480 989	25,4
		OFD 01.99-10.00	92	Fg.-Nr. 8D..X..200 001→	JBH,LLE	0 986 480 935	25,4
		01.99-10.01	85	Fg.-Nr. 8D..X..200 001→	JBH,LLE	0 986 480 935	25,4
	02.99-10.00	92		JBH,LLE	0 986 480 935	25,4	
1.8 quattro	MFD 11.94-12.98	92	Fg.-Nr. →8D..X..199 999	JBH	0 986 480 974	23,8	
	07.95-12.98	85	Fg.-Nr. →8D..X..199 999	JBH	0 986 480 974	23,8	
	01.99-04.99	92	Fg.-Nr. 8D..X..200 001→	JBH,LLE	0 986 480 966	25,4	
	01.99-10.01	85	Fg.-Nr. 8D..X..200 001→	JBH,LLE	0 986 480 966	25,4	
	02.99-10.00	92		JBH,LLE	0 986 480 966	25,4	
	OFD 11.94-12.98	92	Fg.-Nr. →8D..X..199 999	JBH	0 986 480 890	23,81	
	07.95-12.98	85	Fg.-Nr. →8D..X..199 999	JBH	0 986 480 890	23,81	
	1.8 T	11.94-07.98	110		JBH	0 986 480 890	23,81
		08.97-12.98	132		JBH	0 986 480 890	23,81
		08.98-12.98	110	Fg.-Nr. →8D..X..199 999	JBH	0 986 480 890	23,81











		S									
◀ AUDI A4 [8D2; B5]											
1.8 T	MFD	01.99-07.99	110		Fg.-Nr. 8D..X..200 001→		JBH,LLE	0986 480 966	25,4		
		05.99-10.00	110				JBH,LLE	0986 480 966	25,4		
1.8 T quattro	MFD	11.94-12.98	110				JBH	0986 480 974	23,8		
		08.97-12.98	132		Fg.-Nr. →8D..X..199 999		JBH	0986 480 974	23,8		
	01.99-07.99	110		Fg.-Nr. 8D..X..200 001→		JBH,LLE	0986 480 966	25,4			
	01.99-10.00	132		Fg.-Nr. 8D..X..200 001→		JBH,LLE	0986 480 966	25,4			
							JBH,RLE	0986 480 989	25,4		
			02.99-10.00	110				JBH,LLE	0986 480 966	25,4	
		OFD	11.94-12.98	110				JBH	0986 480 890	23,81	
		08.97-12.98	132		Fg.-Nr. →8D..X..199 999		JBH	0986 480 890	23,81		
		01.99-10.00	132		Fg.-Nr. 8D..X..200 001→		JBH,LLE	0986 480 935	25,4		
1.8 T		05.00-08.01	125				JBH	0986 480 935	25,4		
1.8 T quattro	MFD	01.99-07.99	110		Fg.-Nr. 8D..X..200 001→		JBH,RLE	0986 480 989	25,4		
		02.99-10.00	110				JBH,RLE	0986 480 989	25,4		
	OFD	01.99-07.99	110		Fg.-Nr. 8D..X..200 001→		JBH,LLE	0986 480 935	25,4		
		02.99-10.00	110				JBH,LLE	0986 480 935	25,4		
1.9 TDI		11.94-06.00	66				JBH	0986 480 890	23,81		
		02.96-12.98	81/85		Fg.-Nr. →8D..X..199 999		JBH	0986 480 890	23,81		
		03.96-12.98	55		Fg.-Nr. →8D..X..199 999		JBH	0986 480 890	23,81		
		MFD	01.99-07.99	81		Fg.-Nr. 8D..X..200 001→		JBH,LLE	0986 480 966	25,4	
								JBH,RLE	0986 480 989	25,4	
			01.99-10.00	55/66		Fg.-Nr. 8D..X..200 001→		JBH,LLE	0986 480 966	25,4	
								JBH,RLE	0986 480 989	25,4	
			01.99-11.00	85		Fg.-Nr. 8D..X..200 001→		JBH,LLE	0986 480 966	25,4	
								JBH,RLE	0986 480 989	25,4	
			08.99-06.00	81				JBH,LLE	0986 480 966	25,4	
								JBH,RLE	0986 480 989	25,4	
		OFD	01.99-07.99	81		Fg.-Nr. 8D..X..200 001→		JBH,LLE	0986 480 935	25,4	
				01.99-10.00	55/66		Fg.-Nr. 8D..X..200 001→		JBH,LLE	0986 480 935	25,4
			01.99-11.00	85		Fg.-Nr. 8D..X..200 001→		JBH,LLE	0986 480 935	25,4	
			08.99-06.00	81				JBH,LLE	0986 480 935	25,4	
1.9 TDI quattro	MFD	07.96-12.98	81				JBH	0986 480 974	23,8		
		12.98-12.98	85				JBH	0986 480 974	23,8		
			08.99-01.00	81				JBH,LLE	0986 480 966	25,4	
								JBH,RLE	0986 480 989	25,4	
			01.00-10.00	85				JBH,LLE	0986 480 966	25,4	
								JBH,RLE	0986 480 989	25,4	
		OFD	07.96-12.98	81				JBH	0986 480 890	23,81	
				12.98-12.98	85				JBH	0986 480 890	23,81
				08.99-01.00	81				JBH,LLE	0986 480 935	25,4
				01.00-10.00	85				JBH,LLE	0986 480 935	25,4
2.4		07.95-07.97	110				JBH	0986 480 890	23,81		
		08.97-07.98	120				JBH	0986 480 890	23,81		
			121				JBH	0986 480 890	23,81		
			08.98-12.98	120		Fg.-Nr. →8D..X..199 999		JBH	0986 480 890	23,81	
				121		Fg.-Nr. →8D..X..199 999		JBH	0986 480 890	23,81	
		MFD	01.99-06.00	120		Fg.-Nr. 8D..X..200 001→		JBH,LLE	0986 480 966	25,4	
								JBH,RLE	0986 480 989	25,4	
				01.99-10.00	121		Fg.-Nr. 8D..X..200 001→		JBH,LLE	0986 480 966	25,4
								JBH,RLE	0986 480 989	25,4	
			06.00-10.00	120				JBH,LLE	0986 480 966	25,4	
								JBH,RLE	0986 480 989	25,4	
		OFD	01.99-06.00	120		Fg.-Nr. 8D..X..200 001→		JBH,LLE	0986 480 935	25,4	
				01.99-10.00	121		Fg.-Nr. 8D..X..200 001→		JBH,LLE	0986 480 935	25,4
			06.00-10.00	120				JBH,LLE	0986 480 935	25,4	
2.4 quattro	MFD	08.97-07.98	120				JBH	0986 480 974	23,8		
		08.97-12.98	121				JBH	0986 480 974	23,8		
			02.99-06.00	120				JBH,LLE	0986 480 966	25,4	
								JBH,RLE	0986 480 989	25,4	
			02.99-10.00	121				JBH,LLE	0986 480 966	25,4	
							JBH,RLE	0986 480 989	25,4		



		S								
2.4 quattro	OFD	08.97-07.98	120			JBH	0 986 480 890	23,81		
		08.97-12.98	121			JBH	0 986 480 890	23,81		
		02.99-06.00	120			JBH,LLE	0 986 480 935	25,4		
		02.99-10.00	121			JBH,LLE	0 986 480 935	25,4		
2.5 TDI		08.97-12.98	110	Fg.-Nr. →8D..X..199 999		JBH	0 986 480 890	23,81		
	MFD	01.99-10.00	110	Fg.-Nr. 8D..X..200 001→		JBH,LLE	0 986 480 966	25,4		
						JBH,RLE	0 986 480 989	25,4		
	OFD	01.99-10.00	110	Fg.-Nr. 8D..X..200 001→		JBH,LLE	0 986 480 935	25,4		
2.5 TDI quattro	MFD	11.97-12.98	110	Fg.-Nr. →8D..X..199 999		JBH	0 986 480 974	23,8		
		01.99-06.00	110	Fg.-Nr. 8D..X..200 001→		JBH,LLE	0 986 480 966	25,4		
						JBH,RLE	0 986 480 989	25,4		
		02.99-10.00	110			JBH,LLE	0 986 480 966	25,4		
						JBH,RLE	0 986 480 989	25,4		
	OFD	11.97-12.98	110	Fg.-Nr. →8D..X..199 999		JBH	0 986 480 890	23,81		
2.6		11.94-07.98	110			JBH	0 986 480 890	23,81		
		01.96-07.97	102			JBH	0 986 480 890	23,81		
	2.6 quattro	MFD	11.94-07.98	102/110			JBH	0 986 480 974	23,8	
		OFD	11.94-07.98	110			JBH	0 986 480 890	23,81	
		04.95-07.97	102			JBH	0 986 480 890	23,81		
	2.8		11.94-07.97	128			JBH	0 986 480 890	23,81	
		03.96-12.98	142			JBH	0 986 480 890	23,81		
		01.99-08.99	142	Fg.-Nr. 8D..X..200 001→		JBH	0 986 480 935	25,4		
MFD		01.99-06.00	142	Fg.-Nr. 8D..X..200 001→		JBH,LLE	0 986 480 966	25,4		
						JBH,RLE	0 986 480 989	25,4		
OFD		01.99-06.00	142	Fg.-Nr. 8D..X..200 001→		JBH,LLE	0 986 480 935	25,4		
2.8	MFD	03.99-10.00	140			JBH,LLE	0 986 480 966	25,4		
2.8 quattro						JBH,RLE	0 986 480 989	25,4		
	OFD	03.99-10.00	140			JBH,LLE	0 986 480 935	25,4		
2.8 quattro	MFD	11.94-12.96	128			JBH	0 986 480 974	23,8		
		03.96-07.98	142			JBH	0 986 480 974	23,8		
		02.99-10.00	142			JBH,LLE	0 986 480 966	25,4		
						JBH,RLE	0 986 480 989	25,4		
	OFD	11.94-12.96	128			JBH	0 986 480 890	23,81		
		03.96-07.98	142			JBH	0 986 480 890	23,81		
	02.99-10.00	142			JBH,LLE	0 986 480 935	25,4			
1.6		11.94-10.96	74			LLE	0 986 486 083	19		
		10.96-03.97	74	Fg.-Nr. →8D..V..180 000		LLE	0 986 486 083	19		
		03.97-07.99	74	Fg.-Nr. 8D..V..180 001→		LLE	0 986 486 054	19,05		
		08.98-06.00	74			LLE	0 986 486 054	19,05		
		06.00-10.00	75			LLE	0 986 486 054	19,05		
	1.8		04.95-03.97	85	Fg.-Nr. →8D..V..180 000		LLE	0 986 486 083	19	
1.8 quattro		04.95-10.01	85	Fg.-Nr. 8D-V 180 001→		LLE	0 986 486 054	19,05		
1.8, quattro, T, T quattro		11.94-03.97	92/110	Fg.-Nr. →8D..V..180 000		LLE	0 986 486 083	19		
		03.97-04.99	92/110	Fg.-Nr. 8D..V..180 001→		LLE	0 986 486 054	19,05		
		07.98-10.00	92/110			LLE	0 986 486 054	19,05		
1.8 T		08.97-10.00	132			LLE	0 986 486 054	19,05		
1.8 T quattro		05.00-08.01	125				0 986 486 054	19,05		
1.9 TDI		11.94-07.96	66			LLE	0 986 486 083	19		
		03.96-03.97	55	Fg.-Nr. →8D..V..180 000		LLE	0 986 486 083	19		
		03.96-06.00	55	Fg.-Nr. 8D-V 180 001→		LLE	0 986 486 054	19,05		
		08.96-03.97	66	Fg.-Nr. →8D..V..180 000		LLE	0 986 486 083	19		
		03.97-06.00	66	Fg.-Nr. 8D..V..180 001→		LLE	0 986 486 054	19,05		
		04.97-10.00	66			LLE	0 986 486 054	19,05		
1.9 TDI		02.96-03.97	81	Fg.-Nr. →8D..V..180 000		LLE	0 986 486 083	19		
1.9 TDI quattro		03.97-07.99	81	Fg.-Nr. 8D..V..180 001→		LLE	0 986 486 054	19,05		
		08.98-11.00	85			LLE	0 986 486 054	19,05		
		08.99-06.00	81			LLE	0 986 486 054	19,05		
						LLE	0 986 486 054	19,05		
2.4		07.95-03.97	110	Fg.-Nr. →8D..V..180 000		LLE	0 986 486 083	19		
		03.97-07.97	110	Fg.-Nr. 8D..V..180 001→		LLE	0 986 486 054	19,05		
2.4, quattro		08.97-10.00	120/121			LLE	0 986 486 054	19,05		











		S							
AUDI A4 [8D2; B5]									
2.5 TDI, TDI quattro		08.97-10.00	110			LLE	0986 486 054	19,05	
2.6		11.94-03.97	102/110	Fg.-Nr. →8D..V..180 000		LLE	0986 486 083	19	
2.6 quattro		03.97-07.98	102/110	Fg.-Nr. 8D..V..180 001→		LLE	0986 486 054	19,05	
2.8		11.94-03.97	128	Fg.-Nr. →8D..V..180 000		LLE	0986 486 083	19	
		03.96-03.97	142	Fg.-Nr. →8D..V..180 000		LLE	0986 486 083	19	
		10.96-03.97	142	Fg.-Nr. →8D..V..180 000			0986 486 083	19	
		03.97-07.97	128	Fg.-Nr. 8D..V..180 001→		LLE	0986 486 054	19,05	
		03.97-12.98	142	Fg.-Nr. 8D..V..180 001→		LLE	0986 486 054	19,05	
		04.97-08.99	142	Fg.-Nr. 8D..V..180 001→			0986 486 054	19,05	
		08.97-06.00	142			LLE	0986 486 054	19,05	
2.8, quattro		03.99-10.00	140			LLE	0986 486 054	19,05	
2.8 quattro		11.94-12.96	128			LLE	0986 486 083	19	
		03.96-03.97	142	Fg.-Nr. →8D..V..180 000		LLE	0986 486 083	19	
		03.97-07.98	142	Fg.-Nr. 8D..V..180 001→		LLE	0986 486 054	19,05	
		05.97-07.98	142			LLE	0986 486 054	19,05	
		02.99-10.00	142			LLE	0986 486 054	19,05	
1.6		11.94-10.96	74				0986 486 551	22,2	
		10.96-03.97	74	Fg.-Nr. →8D..V..180 000			0986 486 551	22,2	
		03.97-07.99	74	Fg.-Nr. 8D..V..180 001→			0986 486 548	22,2	
		08.98-07.99	74				0986 486 548	22,2	
		06.00-10.00	75				0986 486 548	22,2	
1.8		04.95-03.97	85	Fg.-Nr. →8D..V..180 000			0986 486 551	22,2	
1.8 quattro		04.95-10.01	85	Fg.-Nr. 8D-V 180 001→			0986 486 548	22,2	
1.8, quattro, T, T quattro		11.94-03.97	92/110	Fg.-Nr. →8D..V..180 000			0986 486 551	22,2	
		03.97-04.99	92/110	Fg.-Nr. 8D..V..180 001→			0986 486 548	22,2	
		07.98-10.00	92/110				0986 486 548	22,2	
1.8 T, T quattro		08.97-08.01	125/132				0986 486 548	22,2	
1.9 TDI		11.94-07.96	66				0986 486 551	22,2	
		03.96-03.97	55	Fg.-Nr. →8D..V..180 000			0986 486 551	22,2	
		03.96-06.00	55	Fg.-Nr. 8D-V 180 001→			0986 486 548	22,2	
		08.96-03.97	66	Fg.-Nr. →8D..V..180 000			0986 486 551	22,2	
		03.97-07.99	81	Fg.-Nr. 8D..V..180 001→			0986 486 548	22,2	
		03.97-06.00	66	Fg.-Nr. 8D..V..180 001→			0986 486 548	22,2	
		04.97-10.00	66				0986 486 548	22,2	
		08.99-06.00	81				0986 486 548	22,2	
1.9 TDI quattro		03.97-12.98	81	Fg.-Nr. 8D..V..180 001→			0986 486 548	22,2	
		08.99-01.00	81	Fg.-Nr. →8D..Y..190 000			0986 486 548	22,2	
1.9 TDI		02.96-03.97	81	Fg.-Nr. →8D..V..180 000			0986 486 551	22,2	
1.9 TDI quattro		08.98-11.00	85				0986 486 548	22,2	
2.4		07.95-03.97	110	Fg.-Nr. →8D..V..180 000			0986 486 551	22,2	
		03.97-07.97	110	Fg.-Nr. 8D..V..180 001→			0986 486 548	22,2	
2.4, quattro		08.97-10.00	120/121				0986 486 548	22,2	
2.5 TDI, TDI quattro		08.97-10.00	110				0986 486 548	22,2	
2.6		11.94-03.97	102/110	Fg.-Nr. →8D..V..180 000			0986 486 551	22,2	
2.6 quattro		03.97-07.98	102/110	Fg.-Nr. 8D..V..180 001→			0986 486 548	22,2	
2.8		11.94-03.97	128	Fg.-Nr. →8D..V..180 000			0986 486 551	22,2	
		03.97-07.97	128	Fg.-Nr. 8D..V..180 001→			0986 486 548	22,2	
		03.97-08.99	142	Fg.-Nr. 8D..V..180 001→			0986 486 548	22,2	
		08.97-06.00	142				0986 486 548	22,2	
2.8		03.96-03.97	142	Fg.-Nr. →8D..V..180 000			0986 486 551	22,2	
2.8 quattro		03.99-10.00	140				0986 486 548	22,2	
2.8 quattro		11.94-12.96	128				0986 486 551	22,2	
		03.97-07.98	142	Fg.-Nr. 8D..V..180 001→			0986 486 548	22,2	
		05.97-07.98	142				0986 486 548	22,2	
		02.99-10.00	142				0986 486 548	22,2	
1.6		07.96-10.96	74	Fg.-Nr. 8D..V..000 001→			0 265 216 413 ^B		
							0 265 220 440 ^F		
		10.96-06.97	74	Fg.-Nr. →8D..V..300 000			0 265 220 440 ^F		
							0 265 220 446 ^F		
		10.96-07.97	74				0 265 216 413 ^B		
		10.96-06.00	74				0 265 202 403 ^M		

		S								
1.6	06.97-07.99	74	Fg.-Nr. 8D..V..300 001→	CS2	0 265 220 407 ^E					
	07.97-07.99	74	Fg.-Nr. 8D..V..300 001→	CS2	0 265 220 413 ^F					
	08.97-06.00	74		CS2	0 265 216 564 ^B					
	08.98-06.00	74		CS2	0 265 220 407 ^E					
						0 265 220 413 ^F				
	06.00-10.00	75				0 265 202 403 ^M				
				CS2	0 265 216 564 ^B					
					0 265 220 407 ^E					
					0 265 220 413 ^F					
1.8	11.94-06.97	92	Fg.-Nr. →8D..V..300 000		0 265 220 446 ^F					
	11.94-10.00	92			0 265 202 403 ^M					
	04.95-06.97	85	Fg.-Nr. →8D..V..300 000		0 265 220 446 ^F					
	04.95-06.00	85			0 265 202 403 ^M					
	07.96-06.97	85	Fg.-Nr. 8D..V..000 001→8D..V..300 000		0 265 220 440 ^E					
		92	Fg.-Nr. 8D..V..000 001→8D..V..300 000		0 265 220 440 ^E					
	07.96-07.97	85	Fg.-Nr. 8D..V..000 001→		0 265 216 413 ^B					
		92	Fg.-Nr. 8D..V..000 001→		0 265 216 413 ^B					
	06.97-04.99	92	Fg.-Nr. 8D..V..300 001→	CS2	0 265 220 407 ^E					
	06.97-06.00	85	Fg.-Nr. 8D..V..300 001→	CS2	0 265 220 407 ^E					
	07.97-04.99	92	Fg.-Nr. 8D..V..300 001→	CS2	0 265 220 413 ^F					
	07.97-06.00	85	Fg.-Nr. 8D..V..300 001→	CS2	0 265 220 413 ^F					
	08.97-06.00	85		CS2	0 265 216 564 ^B					
	08.97-10.00	92		CS2	0 265 216 564 ^B					
	08.98-10.00	92		CS2	0 265 220 407 ^E					
						0 265 220 413 ^F				
	1.8 quattro	05.95-07.96	92	Fg.-Nr. 8D..S..105 001→8D..T..400 000		0 265 218 022 ^J				
		07.95-07.96	85	Fg.-Nr. →8D..T..400 000		0 265 218 022 ^J				
07.96-05.97		85	Fg.-Nr. 8D..V..000 001→8D..V..240 000		0 265 220 443 ^E					
		92	Fg.-Nr. 8D..V..000 001→8D..V..240 000		0 265 220 443 ^E					
05.97-04.99		92	Fg.-Nr. 8D..V..240 001→	CS2	0 265 220 410 ^E					
05.97-10.01		85	Fg.-Nr. 8D..V..240 001→	CS2	0 265 220 410 ^E					
06.97-10.00		92			0 265 202 403 ^M					
06.97-10.01		85			0 265 202 403 ^M					
02.99-10.00		92		CS2	0 265 220 410 ^E					
						0 265 220 413 ^F				
1.8 T	11.94-06.97	110	Fg.-Nr. →8D..V..300 000		0 265 220 446 ^F					
	11.94-10.00	110			0 265 202 403 ^M					
	07.96-06.97	110	Fg.-Nr. 8D..V..000 001→8D..V..300 000		0 265 220 440 ^E					
	07.96-07.97	110	Fg.-Nr. 8D..V..000 001→		0 265 216 413 ^B					
	06.97-07.98	110	Fg.-Nr. 8D..V..300 001→	CS2	0 265 220 407 ^E					
	07.97-07.98	110	Fg.-Nr. 8D..V..300 001→	CS2	0 265 220 413 ^F					
	08.97-12.98	132		CS2	0 265 216 564 ^B					
					0 265 220 407 ^E					
					0 265 220 413 ^F					
	08.97-10.00	110		CS2	0 265 216 564 ^B					
	08.98-10.00	110		CS2	0 265 220 407 ^E					
						0 265 220 413 ^F				
	05.00-08.01	125		CS2	0 265 220 407 ^E					
					0 265 220 413 ^F					
1.8 T quattro	05.95-07.96	110	Fg.-Nr. 8D..S..105 001→8D..T..400 000		0 265 218 022 ^J					
	07.96-05.97	110	Fg.-Nr. 8D..V..000 001→8D..V..240 000		0 265 220 443 ^E					
	05.97-12.98	110	Fg.-Nr. 8D..V..240 001→	CS2	0 265 220 410 ^E					
	06.97-10.00	110			0 265 202 403 ^M					
	08.97-10.00	132		CS2	0 265 220 410 ^E					
	07.98-10.00	110		CS2	0 265 220 410 ^E					
	EDS 05.00-08.01	125		CS2	0 265 220 410 ^E					
	MFD 05.00-08.01	125			0 265 202 403 ^M					
1.8 T, T quattro	08.97-10.00	132			0 265 202 403 ^M					
1.9 TDI	02.96-06.97	81	Fg.-Nr. →8D..V..300 000		0 265 220 446 ^F					
	02.96-06.00	81			0 265 202 403 ^M					
	03.96-06.97	55	Fg.-Nr. →8D..V..300 000		0 265 220 446 ^F					
	03.96-06.00	55			0 265 202 403 ^M					
	07.96-06.97	55	Fg.-Nr. 8D..V..000 001→8D..V..300 000		0 265 220 440 ^E					
		81	Fg.-Nr. 8D..V..000 001→8D..V..300 000		0 265 220 440 ^E					



			S								
◀ AUDI A4 [8D2; B5]											
1.9 TDI	07.96-07.97	55	Fg.-Nr. 8D..V..000 001→					0 265 216 413 ^B			
		81	Fg.-Nr. 8D..V..000 001→					0 265 216 413 ^B			
	08.96-06.97	66	Fg.-Nr. →8D..V..300 000					0 265 220 440 ^F			
								0 265 220 446 ^F			
	08.96-07.97	66						0 265 216 413 ^B			
	08.96-10.00	66						0 265 202 403 ^M			
	06.97-07.99	81	Fg.-Nr. 8D..V..300 001→		CS2			0 265 220 407 ^E			
	06.97-06.00	55	Fg.-Nr. 8D..V..300 001→		CS2			0 265 220 407 ^E			
	06.97-10.00	66	Fg.-Nr. 8D..V..300 001→		CS2			0 265 220 407 ^E			
	07.97-07.99	81	Fg.-Nr. 8D..V..300 001→		CS2			0 265 220 413 ^F			
	07.97-06.00	55	Fg.-Nr. 8D..V..300 001→		CS2			0 265 220 413 ^F			
		66	Fg.-Nr. 8D..V..300 001→		CS2			0 265 220 413 ^F			
	08.97-06.00	55			CS2			0 265 216 564 ^B			
		66			CS2			0 265 216 564 ^B			
		81			CS2			0 265 216 564 ^B			
	08.98-11.00	85			CS2			0 265 216 564 ^B			
								0 265 220 407 ^E			
								0 265 220 413 ^F			
	08.99-06.00	81			CS2			0 265 220 407 ^E			
								0 265 220 413 ^F			
1.9 TDI quattro	07.96-05.97	81	Fg.-Nr. →8D..V..240 000					0 265 220 443 ^E			
	05.97-12.98	81	Fg.-Nr. 8D..V..240 001→		CS2			0 265 220 410 ^E			
	06.97-12.98	81						0 265 202 403 ^M			
	12.98-12.98	85			CS2			0 265 220 410 ^E			
	08.99-01.00	81						0 265 202 403 ^M			
						CS2			0 265 220 410 ^E		
	01.00-10.00	85			CS2			0 265 220 410 ^E			
1.9 TDI, TDI quattro	08.98-11.00	85						0 265 202 403 ^M			
2.4	07.95-06.97	110	Fg.-Nr. →8D..V..300 000					0 265 220 440 ^E			
	07.95-07.97	110						0 265 202 403 ^M			
	07.96-07.97	110	Fg.-Nr. 8D..V..000 001→					0 265 216 413 ^B			
	06.97-07.97	110	Fg.-Nr. 8D..V..300 001→		CS2			0 265 220 407 ^E			
	08.97-10.00	120			CS2			0 265 216 564 ^B			
								0 265 220 407 ^E			
								0 265 220 413 ^F			
			121			CS2			0 265 216 564 ^B		
								0 265 220 407 ^E			
								0 265 220 413 ^F			
2.4	08.97-10.00	120						0 265 202 403 ^M			
2.4 quattro		121						0 265 202 403 ^M			
2.4 quattro	08.97-07.98	120			CS2			0 265 220 410 ^E			
	08.97-12.98	121			CS2			0 265 220 410 ^E			
	02.99-06.00	120			CS2			0 265 220 410 ^E			
	02.99-10.00	121			CS2			0 265 220 410 ^E			
2.5 TDI	08.97-10.00	110			CS2			0 265 216 564 ^B			
	01.99-10.00	110	Fg.-Nr. 8D..X..199 001→		CS2			0 265 220 527 ^F			
2.5 TDI quattro	11.97-10.00	110			CS2			0 265 220 410 ^E			
	01.99-06.00	110	Fg.-Nr. 8D..X..199 001→		CS2			0 265 220 527 ^F			
	02.99-10.00	110			CS2			0 265 220 527 ^F			
2.5 TDI, TDI quattro	08.97-10.00	110						0 265 202 403 ^M			
2.6	11.94-06.97	110	Fg.-Nr. →8D..V..300 000					0 265 220 446 ^F			
	01.96-07.97	102						0 265 202 403 ^M			
	07.96-06.97	102	Fg.-Nr. 8D..V..000 001→8D..V..300 000					0 265 220 440 ^E			
		110	Fg.-Nr. 8D..V..000 001→8D..V..300 000					0 265 220 440 ^E			
	07.96-07.97	102	Fg.-Nr. 8D..V..000 001→					0 265 216 413 ^B			
		110	Fg.-Nr. 8D..V..000 001→					0 265 216 413 ^B			
	06.97-07.97	102	Fg.-Nr. 8D..V..300 001→		CS2			0 265 220 407 ^E			
	06.97-07.98	110	Fg.-Nr. 8D..V..300 001→		CS2			0 265 220 407 ^E			
	07.97-07.98	110	Fg.-Nr. 8D..V..300 001→		CS2			0 265 220 413 ^F			
	08.97-07.98	110			CS2			0 265 216 564 ^B			
	2.6 quattro	04.95-07.96	102	Fg.-Nr. →8D..T..400 000					0 265 218 022 ^J		
		05.95-07.96	110	Fg.-Nr. 8D..S..105 001→8D..T..400 000					0 265 218 022 ^J		



		S									
2.6 quattro		07.96-05.97	102	Fg.-Nr. 8D..V..000 001→8D..V..240 000			0 265 220 443 ^E				
			110	Fg.-Nr. 8D..V..000 001→8D..V..240 000			0 265 220 443 ^E				
		05.97-07.97	102	Fg.-Nr. 8D..V..240 001→		CS2		0 265 220 410 ^E			
			110	Fg.-Nr. 8D..V..240 001→		CS2		0 265 220 410 ^E			
		06.97-07.97	102					0 265 202 403 ^M			
		06.97-07.98	110					0 265 202 403 ^M			
2.8		11.94-07.97	128				0 265 202 403 ^M				
		03.96-06.97	142	Fg.-Nr. →8D..V..300 000			0 265 220 446 ^F				
		03.96-06.00	142				0 265 202 403 ^M				
		07.96-06.97	128	Fg.-Nr. 8D..V..000 001→8D..V..300 000				0 265 220 440 ^E			
			142	Fg.-Nr. 8D..V..000 001→8D..V..300 000				0 265 220 440 ^E			
		07.96-07.97	128	Fg.-Nr. 8D..V..000 001→				0 265 216 413 ^B			
			142	Fg.-Nr. 8D..V..000 001→				0 265 216 413 ^B			
		10.96-07.98	142	Fg.-Nr. →8D..W..300 000				0 265 220 440 ^E			
		06.97-07.97	128	Fg.-Nr. 8D..V..300 001→		CS2		0 265 220 407 ^E			
		06.97-12.98	142	Fg.-Nr. 8D..V..300 001→		CS2		0 265 220 407 ^E			
		07.97-12.98	142	Fg.-Nr. 8D..V..300 001→		CS2		0 265 220 413 ^F			
		08.97-07.98	142	Fg.-Nr. 8D..W..007 800→8D..W..300 000				0 265 220 446 ^F			
		08.97-06.00	142			CS2		0 265 216 564 ^B			
								0 265 220 407 ^E			
								0 265 220 413 ^F			
		03.99-10.00	140			CS2		0 265 216 564 ^B			
								0 265 220 407 ^E			
						0 265 220 413 ^F					
2.8, quattro		03.99-10.00	140				0 265 202 403 ^M				
2.8 quattro		05.95-07.96	128	Fg.-Nr. 8D..S..105 001→8D..T..400 000			0 265 218 022 ^J				
		03.96-07.96	142	Fg.-Nr. →8D..T..400 000			0 265 218 022 ^J				
		07.96-05.97	142	Fg.-Nr. 8D..V..000 001→8D..V..240 000				0 265 220 443 ^E			
		05.97-07.98	142			CS2		0 265 220 410 ^E			
		06.97-07.98	142					0 265 202 403 ^M			
		02.99-10.00	142					0 265 202 403 ^M			
						CS2		0 265 220 410 ^E			
		09.99-10.00	140			CS2		0 265 220 410 ^E			
1.6		11.94-06.96	74	Fg.-Nr. →8D..T..300 000			0 265 108 005 ^H				
								0 265 109 002 ^K			
		01.99-06.00	74	Fg.-Nr. 8D..X..200 001→				0 265 109 463 ^M			
		06.00-10.00	75					0 265 109 463 ^M			
		1.8		11.94-06.96	92	Fg.-Nr. →8D..T..300 000			0 265 108 005 ^H		
										0 265 109 002 ^K	
				04.95-06.96	85	Fg.-Nr. →8D..T..300 000				0 265 108 005 ^H	
										0 265 109 002 ^K	
				01.99-06.00	85	Fg.-Nr. 8D..X..200 001→			0 265 109 463 ^M		
				01.99-10.00	92	Fg.-Nr. 8D..X..200 001→			0 265 109 463 ^M		
		04.99-10.00	92				0 265 109 463 ^M				
1.8 quattro		11.94-04.95	92	Fg.-Nr. →8D..S..105 000			0 265 109 026 ^K				
		11.94-04.99	92			FMP,GRG		0 265 109 426 ^M			
		04.95-07.96	92	Fg.-Nr. 8D..S..105 001→8D..T..400 000				0 265 109 031 ^J			
		07.95-07.96	85	Fg.-Nr. →8D..T..400 000				0 265 109 031 ^J			
		07.95-06.99	85	Fg.-Nr. →8D..X..400 000		FMP,GRG		0 265 109 426 ^M			
		02.99-06.99	92	Fg.-Nr. →8D..X..400 000		FMP,GRG		0 265 109 426 ^M			
		07.99-10.00	92	Fg.-Nr. 8D..Y..000 001→		FMP,GRG		0 265 109 462 ^M			
		07.99-10.01	85	Fg.-Nr. 8D..Y..000 001→		FMP,GRG		0 265 109 462 ^M			
1.8 T		11.94-06.96	110	Fg.-Nr. →8D..T..300 000			0 265 108 005 ^H				
								0 265 109 002 ^K			
		11.94-07.98	110					0 265 109 463 ^M			
		08.97-12.98	132					0 265 109 463 ^M			
		01.99-07.99	110	Fg.-Nr. 8D..X..200 001→				0 265 109 463 ^M			
05.99-10.00	110					0 265 109 463 ^M					
1.8 T quattro		11.94-04.95	110	Fg.-Nr. →8D..S..105 000			0 265 109 026 ^K				
		11.94-12.98	110			FMP,GRG		0 265 109 426 ^M			
		04.95-07.96	110	Fg.-Nr. 8D..S..105 001→8D..T..400 000				0 265 109 031 ^J			



		S							
AUDI A4 [8D2; B5]									
1.8 T quattro	08.97-06.99	132	Fg.-Nr. →8D..X..400 000	FMP,GRG	0 265 109 426 ^M				
	07.98-06.99	110	Fg.-Nr. →8D..X..400 000	FMP,GRG	0 265 109 426 ^M				
	07.99-10.00	110		FMP,GRG	0 265 109 462 ^M				
		132	Fg.-Nr. 8D..Y..000 001→	FMP,GRG	0 265 109 462 ^M				
1.9 TDI	11.94-06.96	66	Fg.-Nr. →8D..T..300 000		0 265 108 005 ^H				
					0 265 109 002 ^K				
	02.96-06.96	81	Fg.-Nr. →8D..T..300 000		0 265 108 005 ^H				
					0 265 109 002 ^K				
	03.96-06.96	55	Fg.-Nr. →8D..T..300 000		0 265 108 005 ^H				
					0 265 109 002 ^K				
	08.96-06.00	66			0 265 109 463 ^M				
	01.99-07.99	81	Fg.-Nr. 8D..X..200 001→		0 265 109 463 ^M				
01.99-06.00	55	Fg.-Nr. 8D..X..200 001→		0 265 109 463 ^M					
01.99-11.00	85	Fg.-Nr. 8D..X..200 001→		0 265 109 463 ^M					
1.9 TDI quattro	07.96-12.98	81		FMP,GRG	0 265 109 426 ^M				
	12.98-12.98	85		FMP,GRG	0 265 109 426 ^M				
	08.99-01.00	81		FMP,GRG	0 265 109 462 ^M				
	01.00-10.00	85		FMP,GRG	0 265 109 462 ^M				
2.4	07.95-06.96	110	Fg.-Nr. →8D..T..300 000		0 265 108 005 ^H				
					0 265 109 002 ^K				
	08.97-07.98	120		FMP	0 265 109 463 ^M				
		121		FMP	0 265 109 463 ^M				
	01.99-06.00	120	Fg.-Nr. 8D..X..200 001→		0 265 109 463 ^M				
	01.99-10.00	121	Fg.-Nr. 8D..X..200 001→		0 265 109 463 ^M				
	06.00-10.00	120			0 265 109 463 ^M				
2.4 quattro	08.97-07.98	120		FMP,GRG	0 265 109 426 ^M				
	08.97-12.98	121		FMP,GRG	0 265 109 426 ^M				
	02.99-06.99	120	Fg.-Nr. →8D..X..400 000	FMP,GRG	0 265 109 426 ^M				
		121	Fg.-Nr. →8D..X..400 000	FMP,GRG	0 265 109 426 ^M				
	07.99-06.00	120	Fg.-Nr. 8D..Y..000 001→	FMP,GRG	0 265 109 462 ^M				
	07.99-10.00	121	Fg.-Nr. 8D..Y..000 001→	FMP,GRG	0 265 109 462 ^M				
2.5 TDI	01.99-10.00	110	Fg.-Nr. 8D..X..200 001→		0 265 109 463 ^M				
2.5 TDI quattro	11.97-06.99	110	Fg.-Nr. →8D..X..400 000	FMP,GRG	0 265 109 426 ^M				
	07.99-10.00	110	Fg.-Nr. 8D..Y..000 001→	FMP,GRG	0 265 109 462 ^M				
2.6	11.94-06.96	110	Fg.-Nr. →8D..T..300 000		0 265 108 005 ^H				
					0 265 109 002 ^K				
	11.94-07.98	110		FMP	0 265 109 463 ^M				
	01.96-06.96	102	Fg.-Nr. →8D..T..300 000		0 265 108 005 ^H				
					0 265 109 002 ^K				
2.6 quattro	11.94-04.95	110	Fg.-Nr. →8D..S..105 000		0 265 109 026 ^K				
	11.94-07.98	110		FMP,GRG	0 265 109 426 ^M				
	04.95-07.96	102	Fg.-Nr. →8D..T..400 000		0 265 109 031 ^J				
		110	Fg.-Nr. 8D..S..105 001→8D..T..400 000		0 265 109 031 ^J				
2.8	11.94-06.96	128	Fg.-Nr. →8D..T..300 000		0 265 108 005 ^H				
					0 265 109 002 ^K				
	03.96-06.96	142	Fg.-Nr. →8D..T..300 000		0 265 108 005 ^H				
					0 265 109 002 ^K				
	03.96-12.98	142		FMP	0 265 109 463 ^M				
	10.96-07.97	142	Fg.-Nr. →8D..W..007 799		0 265 109 002 ^K				
	01.99-06.00	142	Fg.-Nr. 8D..X..200 001→		0 265 109 463 ^M				
	03.99-10.00	140			0 265 109 463 ^M				
2.8 quattro	11.94-04.95	128	Fg.-Nr. →8D..S..105 000		0 265 109 026 ^K				
	04.95-07.96	128	Fg.-Nr. 8D..S..105 001→8D..T..400 000		0 265 109 031 ^J				
	03.96-07.96	142	Fg.-Nr. →8D..T..400 000		0 265 109 031 ^J				
	03.96-07.98	142		FMP,GRG	0 265 109 426 ^M				
	02.99-06.99	142	Fg.-Nr. →8D..X..400 000	FMP,GRG	0 265 109 426 ^M				
	07.99-10.00	142		FMP,GRG	0 265 109 462 ^M				
	09.99-10.00	140		FMP,GRG	0 265 109 462 ^M				
1.6	11.94-10.00	74/75			0 265 005 162 ^S				
	1.8, quattro, T, T quattro	11.94-10.01	85/92/110/132		0 265 005 162 ^S				
	1.9 TDI, TDI quattro	11.94-11.00	55/66/81/85		0 265 005 162 ^S				
	2.4, quattro	07.95-10.00	110/120/121		0 265 005 162 ^S				

2.5 TDI, TDI quattro	08.97-10.00	110						0 265 005 162 ⁵
2.6, quattro	11.94-07.98	102/110						0 265 005 162 ⁵
2.8, quattro	11.94-10.00	128/140/142						0 265 005 162 ⁵
1.6	11.94-10.00	74/75						0 265 005 207 0 265 005 214
1.8, quattro, T, T quattro	11.94-10.01	85/92/110/ 132						0 265 005 207 0 265 005 214
1.9 TDI	11.94-11.00	55/66/81/						0 265 005 207
1.9 TDI quattro		85						0 265 005 214
2.4	07.95-10.00	110/120/						0 265 005 207
2.4 quattro		121						0 265 005 214
2.5 TDI	08.97-10.00	110						0 265 005 207
2.5 TDI quattro								0 265 005 214
2.6	11.94-07.98	102/110						0 265 005 214
2.6, quattro	11.94-07.98	102/110						0 265 005 207
2.8	11.94-10.00	128/140/						0 265 005 207
2.8 quattro		142						0 265 005 214
A4 [8EC; B7]								
1.6	11.04-06.08	75			JBH	GIR	0 986 481 046	25,4
1.8 T, T quattro	11.04-06.08	120			JBH	GIR	0 986 481 046	25,4
1.9 TDI	11.04-11.05	84			JBH	GIR	0 986 481 046	25,4
	01.06-06.08	85			JBH	GIR	0 986 481 046	25,4
2.0, TDI, TDI quattro, TFSI, TFSI quattro	11.04-06.08	89/93/96/100/103/120/125/147/162			JBH	GIR	0 986 481 046	25,4
2.5 TDI	11.04-05.06	120			JBH	GIR	0 986 481 046	25,4
2.7 TDI	11.05-06.08	120/132			JBH	GIR	0 986 481 046	25,4
3.0, quattro, TDI quattro	11.04-06.08	150/160/171			JBH	GIR	0 986 481 046	25,4
3.2 FSI, FSI quattro	01.05-06.08	188			JBH	GIR	0 986 481 046	25,4
1.6	11.04-06.08	75			LLE		0 986 486 062	19,05
1.8 T, T quattro	11.04-06.08	120			LLE		0 986 486 062	19,05
1.9 TDI	11.04-11.05	84			LLE		0 986 486 062	19,05
	01.06-06.08	85			LLE		0 986 486 062	19,05
2.0, TDI, TDI quattro, TFSI	11.04-06.08	89/93/96/100/103/120/125			LLE		0 986 486 062	19,05
2.0 TFSI	11.04-06.08	147			LLE		0 986 486 062	19,05
2.0 TFSI quattro	01.05-05.06	147					0 986 486 062	19,05
	06.05-06.08	162			LLE		0 986 486 062	19,05
2.5 TDI	11.04-05.06	120			LLE		0 986 486 062	19,05
2.7 TDI	11.05-06.08	120/132			LLE		0 986 486 062	19,05
3.0, quattro, TDI quattro	11.04-06.08	150/160/171			LLE		0 986 486 062	19,05
3.2 FSI, FSI quattro	01.05-06.08	188			LLE		0 986 486 062	19,05
1.6	11.04-06.08	75					0 986 486 583	22,2
1.8 T, T quattro	11.04-06.08	120					0 986 486 583	22,2
1.9 TDI	11.04-11.05	84					0 986 486 583	22,2
	01.06-06.08	85					0 986 486 583	22,2
2.0, TDI, TDI quattro, TFSI, TFSI quattro	11.04-06.08	89/93/96/100/103/120/125/147/162					0 986 486 583	22,2
2.5 TDI	11.04-05.06	120					0 986 486 583	22,2
2.7 TDI	11.05-06.08	120/132					0 986 486 583	22,2
3.0, quattro, TDI quattro	11.04-06.08	150/160/171					0 986 486 583	22,2
3.2 FSI, FSI quattro	01.05-06.08	188					0 986 486 583	22,2
1.6	11.04-05.05	75	Fg.-Nr. →8E..5..600 000				0 265 234 332 ^T	
	06.05-06.08	75	Fg.-Nr. 8E..6..000 001→				0 265 234 338 ^T	
1.8 T	11.04-05.05	120	Fg.-Nr. →8E..5..600 000				0 265 234 332 ^T	
	06.05-06.08	120	Fg.-Nr. 8E..6..000 001→				0 265 234 338 ^T	
1.8 T quattro	11.04-05.05	120	Fg.-Nr. →8E..5..600 000				0 265 234 329 ^T	
	06.05-06.08	120	Fg.-Nr. 8E..6..000 001→				0 265 234 335 ^T	



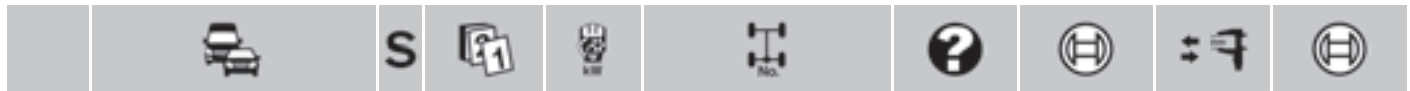

◀ AUDI A4 [8EC; B7]

1.9 TDI	11.04-05.05	84	Fg.-Nr. →8E..5..600 000	0 265 234 332 ^T
	06.05-11.05	84	Fg.-Nr. 8E..6..000 001→	0 265 234 338 ^T
	01.06-06.08	85		0 265 234 338 ^T
2.0	11.04-05.05	96	Fg.-Nr. →8E..5..600 000	0 265 234 332 ^T
	06.05-06.08	96	Fg.-Nr. 8E..6..000 001→	0 265 234 338 ^T
2.0 TDI	11.04-05.05	100	Fg.-Nr. →8E..5..600 000	0 265 234 332 ^T
		103		0 265 234 332 ^T
	06.05-10.05	100	Fg.-Nr. 8E..6..000 001→	0 265 234 338 ^T
	06.05-06.08	103		0 265 234 338 ^T
	11.05-11.06	89/93		0 265 234 338 ^T
	11.05-06.08	100		0 265 234 338 ^T
2.0 TDI quattro	01.06-06.08	103		0 265 234 335 ^T
	06.06-06.08	120/125		0 265 234 335 ^T
2.0 TDI, TFSI	06.06-06.08	120/125		0 265 234 338 ^T
2.0 TFSI	11.04-05.05	147	Fg.-Nr. →8E..5..600 000	0 265 234 332 ^T
	06.05-05.06	147	Fg.-Nr. 8E..6..000 001→	0 265 234 338 ^T
	06.05-06.08	162		0 265 234 338 ^T
	09.05-06.08	147		0 265 234 338 ^T
2.0 TFSI quattro	11.04-05.05	147	Fg.-Nr. →8E..5..600 000	0 265 234 329 ^T
	06.05-05.06	147	Fg.-Nr. 8E..6..000 001→	0 265 234 335 ^T
	06.05-06.08	162		0 265 234 335 ^T
	09.05-06.08	147		0 265 234 335 ^T
2.5 TDI	11.04-05.05	120	Fg.-Nr. →8E..5..600 000	0 265 234 332 ^T
	06.05-05.06	120	Fg.-Nr. 8E..6..000 001→	0 265 234 338 ^T
2.7 TDI	11.05-06.08	120/132		0 265 234 338 ^T
3.0	11.04-05.05	160	Fg.-Nr. →8E..5..600 000	0 265 234 332 ^T
	06.05-05.06	160	Fg.-Nr. 8E..6..000 001→	0 265 234 338 ^T
3.0 quattro	11.04-05.05	160	Fg.-Nr. →8E..5..600 000	0 265 234 329 ^T
	06.05-05.06	160	Fg.-Nr. 8E..6..000 001→	0 265 234 335 ^T
3.0 TDI quattro	01.05-05.05	150	Fg.-Nr. →8E..5..600 000	0 265 234 329 ^T
	06.05-05.06	150	Fg.-Nr. 8E..6..000 001→	0 265 234 335 ^T
	01.06-06.08	171		0 265 234 335 ^T
3.2 FSI	01.05-05.05	188	Fg.-Nr. →8E..5..600 000	0 265 234 332 ^T
	06.05-06.08	188	Fg.-Nr. 8E..6..000 001→	0 265 234 338 ^T
3.2 FSI quattro	01.05-05.05	188	Fg.-Nr. →8E..5..600 000	0 265 234 329 ^T
	06.05-06.08	188	Fg.-Nr. 8E..6..000 001→	0 265 234 335 ^T

	1.6	11.04-05.05	75	Fg.-Nr. →8E..5..600 000	0 265 005 692
		06.05-06.08	75	Fg.-Nr. 8E..6..000 001→, PR-Code G0C, PR-Code G0G, PR-Code G0K	0 265 005 619
				Fg.-Nr. 8E..6..000 001→, PR-Code G0Z	0 265 005 621
	1.8 T	11.04-05.05	120	Fg.-Nr. →8E..5..600 000	0 265 005 692
	1.8 T quattro	06.05-06.08	120	Fg.-Nr. 8E..6..000 001→, PR-Code G0C, PR-Code G0G, PR-Code G0K	0 265 005 619
				Fg.-Nr. 8E..6..000 001→, PR-Code G0Z	0 265 005 621
	1.9 TDI	11.04-05.05	84	Fg.-Nr. →8E..5..600 000	0 265 005 692
		06.05-11.05	84	Fg.-Nr. 8E..6..000 001→, PR-Code G0C, PR-Code G0G, PR-Code G0K	0 265 005 619
		01.06-06.08	85	PR-Code G0C, PR-Code G0G, PR-Code G0K	0 265 005 619
				PR-Code G0Z	0 265 005 621
	2.0	11.04-05.05	96	Fg.-Nr. →8E..5..600 000	0 265 005 692
		06.05-06.08	96	Fg.-Nr. 8E..6..000 001→, PR-Code G0C, PR-Code G0G, PR-Code G0K	0 265 005 619
				Fg.-Nr. 8E..6..000 001→, PR-Code G0Z	0 265 005 621
	2.0 TDI	11.04-05.05	100	Fg.-Nr. →8E..5..600 000	0 265 005 692
			103		0 265 005 692
		06.05-10.05	100	Fg.-Nr. 8E..6..000 001→, PR-Code G0C, PR-Code G0G, PR-Code G0K	0 265 005 619
				Fg.-Nr. 8E..6..000 001→, PR-Code G0Z	0 265 005 621

	S							
2.0 TDI	06.05-06.08	103	Fg.-Nr. 8E..6..000 001→, PR-Code G0C, PR-Code G0G, PR-Code G0K		0 265 005 619			
			Fg.-Nr. 8E..6..000 001→, PR-Code G0Z		0 265 005 621			
			PR-Code G0C, PR-Code G0G, PR-Code G0K		0 265 005 619			
			PR-Code G0Z		0 265 005 621			
	11.05-11.06	89/93	PR-Code G0C, PR-Code G0G, PR-Code G0K		0 265 005 619			
			PR-Code G0Z		0 265 005 621			
2.0 TDI quattro	01.06-06.08	103	PR-Code G0C, PR-Code G0G, PR-Code G0K		0 265 005 619			
			PR-Code G0Z		0 265 005 621			
2.0 TDI, TDI quattro, TFSI	06.06-06.08	120/125	PR-Code G0C, PR-Code G0G, PR-Code G0K		0 265 005 619			
		PR-Code G0Z		0 265 005 621				
2.0 TFSI	11.04-05.05	147	Fg.-Nr. →8E..5..600 000		0 265 005 692			
2.0 TFSI quattro	06.05-05.06	147	Fg.-Nr. 8E..6..000 001→, PR-Code G0C, PR-Code G0G, PR-Code G0K		0 265 005 619			
			Fg.-Nr. 8E..6..000 001→, PR-Code G0Z		0 265 005 621			
	06.05-06.08	162	PR-Code G0C, PR-Code G0G, PR-Code G0K		0 265 005 619			
			PR-Code G0Z		0 265 005 621			
2.5 TDI	11.04-05.05	120	Fg.-Nr. →8E..5..600 000		0 265 005 692			
	06.05-05.06	120	Fg.-Nr. 8E..6..000 001→, PR-Code G0C, PR-Code G0G, PR-Code G0K		0 265 005 619			
		Fg.-Nr. 8E..6..000 001→, PR-Code G0Z		0 265 005 621				
2.7 TDI	11.05-06.08	120/132	PR-Code G0C, PR-Code G0G, PR-Code G0K		0 265 005 619			
			PR-Code G0Z		0 265 005 621			
3.0	11.04-05.05	150/160	Fg.-Nr. →8E..5..600 000		0 265 005 692			
3.0 quattro	06.05-05.06	150/160	Fg.-Nr. 8E..6..000 001→, PR-Code G0C, PR-Code G0G, PR-Code G0K		0 265 005 619			
3.0 TDI quattro			Fg.-Nr. 8E..6..000 001→, PR-Code G0Z		0 265 005 621			
	01.06-06.08	171	PR-Code G0C, PR-Code G0G, PR-Code G0K		0 265 005 619			
		PR-Code G0Z		0 265 005 621				
3.2 FSI	01.05-05.05	188	Fg.-Nr. →8E..5..600 000		0 265 005 692			
3.2 FSI quattro	06.05-06.08	188	Fg.-Nr. 8E..6..000 001→, PR-Code G0C, PR-Code G0G, PR-Code G0K		0 265 005 619			
			Fg.-Nr. 8E..6..000 001→, PR-Code G0Z		0 265 005 621			
A4 [8E2; B6]								
	1.6	10.00-12.04	75		JBH	GIR	0 986 481 046	25,4
	1.8 i Turbo, T, T quattro	12.00-08.08	110/120/125/140		JBH	GIR	0 986 481 046	25,4
	1.9 TDI, TDI quattro	12.00-12.04	74/85/96		JBH	GIR	0 986 481 046	25,4
	2.0, FSI	12.00-12.04	96/110		JBH	GIR	0 986 481 046	25,4
	2.4	04.01-12.04	120/125		JBH	GIR	0 986 481 046	25,4
	2.5 TDI, TDI quattro	12.00-12.04	114/120/132		JBH	GIR	0 986 481 046	25,4
	3.0, quattro	12.00-08.05	160/162		JBH	GIR	0 986 481 046	25,4
	1.6	10.00-12.04	75		LLE		0 986 486 062	19,05
	1.8 T, T quattro	12.00-08.05	110/120/125/140		LLE		0 986 486 062	19,05
	1.9 TDI, TDI quattro	12.00-12.04	74/85/96		LLE		0 986 486 062	19,05
	2.0, FSI	12.00-12.04	96/110		LLE		0 986 486 062	19,05
	2.4	04.01-12.04	120/125		LLE		0 986 486 062	19,05
	2.5 TDI, TDI quattro	12.00-12.04	114/120/132		LLE		0 986 486 062	19,05
	3.0, quattro	12.00-12.04	160/162		LLE		0 986 486 062	19,05
	1.6	10.00-04.04	75	Fg.-Nr. →8E..4..270 000			0 986 486 548	22,2
		05.04-12.04	75	Fg.-Nr. 8E..4..270 000→			0 986 486 583	22,2
	1.8 T, T quattro	12.00-06.02	110				0 986 486 548	22,2
		07.01-08.05	125				0 986 486 548	22,2
		07.02-04.04	120	Fg.-Nr. →8E..4..270 000			0 986 486 548	22,2



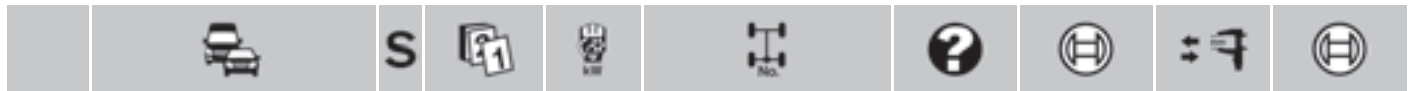

AUDI A4 [8E2; B6]

1.8 T, T quattro	11.02-04.04	140	Fg.-Nr. →8E..4..270 000	0 986 486 548	22,2
	05.04-12.04	120	Fg.-Nr. 8E..4..270 000→	0 986 486 583	22,2
		140	Fg.-Nr. 8E..4..270 000→	0 986 486 583	22,2
1.9 TDI	04.01-05.04	74		0 986 486 548	22,2
1.9 TDI, TDI quattro	12.00-12.04	96		0 986 486 583	22,2
2.0	12.00-04.04	96/110	Fg.-Nr. →8E..4..270 000	0 986 486 548	22,2
2.0 FSI	05.04-12.04	96/110	Fg.-Nr. 8E..4..270 000→	0 986 486 583	22,2
2.4	04.01-12.04	120/125		0 986 486 548	22,2
2.5 TDI	04.01-06.02	114		0 986 486 548	22,2
2.5 TDI	12.00-05.03	120/132		0 986 486 548	22,2
2.5 TDI quattro	11.02-04.04	120/132	Fg.-Nr. →8E..4..270 000	0 986 486 548	22,2
	05.04-12.04	120/132	Fg.-Nr. 8E..4..270 000→	0 986 486 583	22,2
3.0	12.00-04.04	162	Fg.-Nr. →8E..4..270 000	0 986 486 548	22,2
3.0 quattro	03.01-04.04	160	Fg.-Nr. →8E..4..270 000	0 986 486 548	22,2
	09.01-05.04	162		0 986 486 548	22,2
	05.04-12.04	160	Fg.-Nr. 8E..4..270 000→	0 986 486 583	22,2
		162	Fg.-Nr. 8E..4..270 000→	0 986 486 583	22,2

1.6	10.00-12.04	75		CS2	0 265 225 050 ^T
1.8 i Turbo, T	12.00-08.08	110/120/125/140		CS2	0 265 225 050 ^T
1.8 T quattro	12.00-12.04	110/120/125/140			0 265 225 047 ^T
1.9 TDI	12.00-12.04	96		CS2	0 265 225 050 ^T
	04.01-12.04	74/85		CS2	0 265 225 050 ^T
1.9 TDI quattro	04.01-12.04	96			0 265 225 047 ^T
2.0, FSI	12.00-12.04	96/110		CS2	0 265 225 050 ^T
2.4	04.01-12.04	120/125		CS2	0 265 225 050 ^T
2.5 TDI	04.01-12.04	114/120		CS2	0 265 225 050 ^T
2.5 TDI quattro	12.00-12.04	132			0 265 225 047 ^T
3.0	12.00-12.04	160/162		CS2	0 265 225 050 ^T
3.0 quattro	12.00-12.04	160/162			0 265 225 047 ^T

1.6	10.00-12.04	75			0 265 005 252
1.8 i Turbo, T, T quattro	12.00-08.08	110/120/125/140			0 265 005 252
1.9 TDI, TDI quattro	12.00-12.04	74/85/96			0 265 005 252
2.0, FSI	12.00-12.04	96/110			0 265 005 252
2.4	04.01-12.04	120/125			0 265 005 252
2.5 TDI, TDI quattro	12.00-12.04	114/120/132			0 265 005 252
3.0, quattro	12.00-12.04	160/162			0 265 005 252













1.6	10.00-12.04	75			0 265 005 303
1.8 i Turbo, T, T quattro	12.00-08.08	110/120/125/140			0 265 005 303
1.9 TDI, TDI quattro	12.00-12.04	74/85/96			0 265 005 303
2.0, FSI	12.00-12.04	96/110			0 265 005 303
2.4	04.01-12.04	120/125			0 265 005 303
2.5 TDI, TDI quattro	12.00-12.04	114/120/132			0 265 005 303
3.0, quattro	12.00-12.04	160/162			0 265 005 303

A4 [8K2; B4]

2.0 TFSI	05.13→	165		TW	0 265 005 741

A4 [8K2; B8]

1.8 TFSI	01.08-05.08	88	PR-Code 1AT		0 265 236 086 ^T
		118	Fg.-Nr. 8K..8A011 501→, 8K..8N003 201→,		0 265 236 086 ^T
			PR-Code 1AT		
2.7 TDI	01.08-05.08	120/140	Fg.-Nr. 8K..8A011 501→, 8K..8N003 201→,		0 265 236 086 ^T
	06.08-11.09	120/140	PR-Code 1AT		0 265 236 086 ^T

										
3.2 FSI		09.08-11.09	195	PR-Code 1AT			0 265 236 086 ^T			
 1.8 TFSI		11.07-05.08	118			NAD	0 265 005 741			
		01.08-05.08	88			NAD	0 265 005 741			
		06.08-03.12	118			FDS	0 265 005 741			
						FDS	0 265 005 739			
		06.08→	88			FDS	0 265 005 741			
						FDS	0 265 005 739			
	OAD	11.07-05.08	118				0 265 005 739			
		01.08-05.08	88				0 265 005 739			
	1.8 TFSI quattro		09.08-03.12	118			FDS	0 265 005 741		
							FDS	0 265 005 739		
2.0 TDI		11.07→	100			FDS	0 265 005 741			
						FDS	0 265 005 739			
		01.08-03.12	120			FDS	0 265 005 741			
						FDS	0 265 005 739			
		06.08-03.12	88			FDS	0 265 005 741			
						FDS	0 265 005 739			
		09.13→	120			TW	0 265 005 741			
		04.14→	100			TW	0 265 005 741			
2.0 TDI		11.07-03.12	105			FDS	0 265 005 741			
2.0 TDI quattro						FDS	0 265 005 739			
		05.13→	110			TW	0 265 005 741			
		09.13→	140			TW	0 265 005 741			
2.0 TDI, TDI quattro, TFSI, TFSI flexible fuel, TFSI quattro flexible fuel		01.08→	125/132			FDS	0 265 005 741			
						FDS	0 265 005 739			
2.0 TFSI		06.08→	155			FDS	0 265 005 741			
2.0 TFSI quattro						FDS	0 265 005 739			
		05.13→	162/165			TW	0 265 005 741			
2.7 TDI		11.07-05.08	120			NAD	0 265 005 741			
			140			NAD	0 265 005 741			
		06.08-03.12	120			FDS	0 265 005 741			
						FDS	0 265 005 739			
			140			FDS	0 265 005 741			
						FDS	0 265 005 739			
OAD		11.07-05.08	120				0 265 005 739			
			140				0 265 005 739			
3.0 TDI quattro		11.07-05.08	176			NAD	0 265 005 741			
		06.08-05.10	155			FDS	0 265 005 741			
						FDS	0 265 005 739			
		06.08-03.12	176			FDS	0 265 005 741			
						FDS	0 265 005 739			
OAD		11.07-05.08	176				0 265 005 739			
3.0 TDI quattro, TFSI quattro		05.13→	180/200			TW	0 265 005 741			
3.2 FSI		01.08-03.12	195			FDS	0 265 005 741			
3.2 FSI quattro						FDS	0 265 005 739			
A5 Cabriolet [8F7]										
										
 1.8 TFSI		09.09→	118/125			FDS	0 265 005 741			
						PR-Code GP1	FDS	0 265 005 739		
	2.0 TDI		10.11-05.13	105			FDS	0 265 005 741		
						PR-Code GP1	FDS	0 265 005 739		
			05.13-05.15	110			FDS	0 265 005 741		
						PR-Code GP1	FDS	0 265 005 739		
			05.14→	110			PR-Code GP1	0 265 005 739		
						PR-Code GP1, PR-Code GP2		0 265 005 741		
	2.0 TDI		03.09→	120/125/			FDS	0 265 005 741		
	2.0 TDI quattro			130/132/		PR-Code GP1	FDS	0 265 005 739		
2.0 TFSI			140/							
2.0 TFSI quattro			155-157/							
2.0 TFSI quattro flexible fuel			162/165							



			S							
◀ AUDI A5 Cabriolet [8F7]										
	2.7 TDI	03.09-03.12	120/140				FDS	0 265 005 741		
					PR-Code GP1		FDS	0 265 005 739		
	3.0 FSI quattro	11.11-06.14	200				FDS	0 265 005 741		
					PR-Code GP1		FDS	0 265 005 739		
	3.0 TDI	03.09→	150/176/				FDS	0 265 005 741		
	3.0 TDI quattro		180		PR-Code GP1		FDS	0 265 005 739		
	3.0 TFSI quattro	05.14→	200				FDS	0 265 005 739		
					PR-Code GP1, PR-Code GP2		FDS	0 265 005 741		
	3.2 FSI	03.09-03.12	195				FDS	0 265 005 741		
	3.2 FSI quattro				PR-Code GP1		FDS	0 265 005 739		
A5 Coupé [8T3]										
	1.8 TFSI	01.08-11.08	125		PR-Code 1AT			0 265 236 086 ^T		
	2.7 TDI	01.08-05.08	120/140		PR-Code 1AT			0 265 236 086 ^T		
	3.2 FSI	01.08-03.12	195		PR-Code 1AT			0 265 236 086 ^T		
	1.8 TFSI	10.07-11.08	125				FDS	0 265 005 739		
							FDS	0 265 005 741		
		05.09-09.11	118				FDS	0 265 005 741		
							FDS	0 265 005 739		
		08.11→	125				NAD	0 265 005 741		
		OAD 08.11→	125		PR-Code GP1			0 265 005 739		
	2.0 TDI	01.08-09.08	120		Fg.-Nr. →8T..9..024 400			0 265 005 739		
		01.08-03.12	120				FDS	0 265 005 741		
		10.08-03.12	120		Fg.-Nr. 8T..9..024 401→			0 265 005 739		
		08.11→	120				NAD	0 265 005 741		
		09.13→	120				FDS	0 265 005 741		
						PR-Code GP1		FDS	0 265 005 739	
		OAD 08.11→	120		PR-Code GP1			0 265 005 739		
		2.0 TDI	01.08-09.08	125		Fg.-Nr. →8T..9..024 400			0 265 005 739	
	2.0 TDI quattro	01.08-03.12	125				FDS	0 265 005 741		
		10.08-03.12	125		Fg.-Nr. 8T..9..024 401→			0 265 005 739		
		08.11→	130				NAD	0 265 005 741		
		09.13→	140				FDS	0 265 005 741		
					PR-Code GP1		FDS	0 265 005 739		
		OAD 08.11→	130/155/ 162/165		PR-Code GP1			0 265 005 739		
	2.0 TFSI	09.08-09.08	132		Fg.-Nr. →8T..9..024 400			0 265 005 739		
		09.08→	132				FDS	0 265 005 741		
		10.08→	132		Fg.-Nr. 8T..9..024 401→			0 265 005 739		
		2.0 TFSI quattro flexible fuel	03.12-05.13	155				NAD	0 265 005 741	
	2.0 TFSI	06.08-09.08	155		Fg.-Nr. →8T..9..024 400			0 265 005 739		
		2.0 TFSI quattro	06.08-05.13	155				FDS	0 265 005 741	
		10.08-05.13	155		Fg.-Nr. 8T..9..024 401→			0 265 005 739		
		2.0 TFSI, TFSI quattro, TFSI quattro flexible fuel	05.13→	162/165				FDS	0 265 005 741	
	2.7 TDI	07.07-05.08	120/140					0 265 005 739		
		07.07-03.12	120/140				FDS	0 265 005 741		
		05.08-09.08	120/140		Fg.-Nr. →8T..9..024 400			0 265 005 739		
		10.08-03.12	120/140		Fg.-Nr. 8T..9..024 401→			0 265 005 739		
	3.0 TDI	10.11→	150				NAD	0 265 005 741		
		3.0 TDI quattro	06.07-05.08	176					0 265 005 739	
		06.07-03.12	176				FDS	0 265 005 741		
		03.08-09.08	176		Fg.-Nr. →8T..9..024 400			0 265 005 739		
		03.08-05.10	155					0 265 005 739		
							FDS	0 265 005 741		
		10.08-03.12	176		Fg.-Nr. 8T..9..024 401→			0 265 005 739		
		08.11→	180				NAD	0 265 005 741		
	3.0 TDI, TDI quattro	OAD 08.11→	150/180		PR-Code GP1			0 265 005 739		



		S								
3.0 TFSI quattro		12.11→	200			NAD		0 265 005 741		
		05.14→	200	PR-Code GP1				0 265 005 739		
				PR-Code GP1, PR-Code GP2				0 265 005 741		
		OAD 12.11→	200	PR-Code GP1				0 265 005 739		
3.2 FSI		06.07-09.08	195	Fg.-Nr. →8T..9..024 400				0 265 005 739		
3.2 FSI quattro		06.07-03.12	195			FDS		0 265 005 741		
		10.08-03.12	195	Fg.-Nr. 8T..9..024 401→				0 265 005 739		
A5 Sportback [8TA]										
1.8 TFSI		11.09-09.11	118			FDS		0 265 005 741		
						FDS		0 265 005 739		
		08.11→	125			NAD		0 265 005 741		
		09.14→	106	PR-Code GP1				0 265 005 739		
				PR-Code GP1, PR-Code GP2				0 265 005 741		
		OAD 08.11→	125	PR-Code GP1				0 265 005 739		
2.0 TDI		09.09-03.12	100			FDS		0 265 005 741		
						FDS		0 265 005 739		
			105			FDS		0 265 005 741		
						FDS		0 265 005 739		
			120			FDS		0 265 005 741		
						FDS		0 265 005 739		
			08.11→	120			NAD		0 265 005 741	
				130			NAD		0 265 005 741	
			11.11→	100			NAD		0 265 005 741	
				105			NAD		0 265 005 741	
			05.13→	110			FDS		0 265 005 741	
					PR-Code GP1		FDS		0 265 005 739	
			09.13→	120			FDS		0 265 005 741	
					PR-Code GP1		FDS		0 265 005 739	
			04.14→	100	PR-Code GP1				0 265 005 739	
				PR-Code GP1, PR-Code GP2				0 265 005 741		
			110	PR-Code GP1				0 265 005 739		
				PR-Code GP1, PR-Code GP2				0 265 005 741		
		OAD 08.11→	120	PR-Code GP1				0 265 005 739		
			110	PR-Code GP1				0 265 005 739		
			105	PR-Code GP1				0 265 005 739		
2.0 TDI		09.09-03.12	125			FDS		0 265 005 741		
2.0 TDI quattro						FDS		0 265 005 739		
		09.13→	140			FDS		0 265 005 741		
				PR-Code GP1		FDS		0 265 005 739		
2.0 TDI, TFSI, TFSI quattro		OAD 08.11→	130/165	PR-Code GP1				0 265 005 739		
2.0 TFSI		09.09→	132			FDS		0 265 005 741		
						FDS		0 265 005 739		
2.0 TFSI		09.09→	155			FDS		0 265 005 741		
2.0 TFSI quattro						FDS		0 265 005 739		
		05.13→	165			FDS		0 265 005 741		
2.7 TDI		09.09-03.12	120/140			FDS		0 265 005 741		
						FDS		0 265 005 739		
3.0 TDI		10.11→	150			NAD		0 265 005 741		
		OAD 10.11→	150	PR-Code GP1				0 265 005 739		
3.0 TDI quattro		05.09-03.12	155/176			FDS		0 265 005 741		
						FDS		0 265 005 739		
		08.11→	180			NAD		0 265 005 741		
		06.13→	180			FDS		0 265 005 741		
					PR-Code GP1		FDS		0 265 005 739	
		OAD 08.11→	180	PR-Code GP1				0 265 005 739		
3.0 TFSI quattro		12.11→	200			NAD		0 265 005 741		
		05.14→	200	PR-Code GP1				0 265 005 739		
				PR-Code GP1, PR-Code GP2				0 265 005 741		
		OAD 12.11→	200	PR-Code GP1				0 265 005 739		





	◀ AUDI A5 Sportback [8TA]						
	3.2 FSI quattro	09.09-03.12	195		FDS	0 265 005 741	
					FDS	0 265 005 739	

A6 Allroad [4BH; C5]



	2.5 TDI	05.00-08.05	120/132		JBH,LLE	0 986 480 966	25,4
					JBH,RLE	0 986 480 989	25,4
	2.7 T	05.00-08.05	184		JBH,LLE	0 986 480 966	25,4
					JBH,RLE	0 986 480 989	25,4
		09.01-08.05	187		JBH	0 986 480 966	25,4
	4.2	07.02-08.05	220		JBH,LLE	0 986 480 966	25,4
					JBH,RLE	0 986 480 989	25,4

	2.5 TDI	05.00-06.01	132	Fg.-Nr. →4B..1..200 000	LLE	0 986 486 054	19,05
		07.01-05.03	132	Fg.-Nr. 4B..2..000 001→	LLE	0 986 486 061	19,05
		06.03-08.05	120		LLE	0 986 486 061	19,05
			132		LLE	0 986 486 061	19,05
	2.7 T	05.00-06.01	184	Fg.-Nr. →4B..1..200 000	LLE	0 986 486 054	19,05
		07.01-06.02	184	Fg.-Nr. 4B..2..000 001→	LLE	0 986 486 061	19,05
		09.01-08.05	187			0 986 486 054	19,05
						0 986 486 061	19,05
		07.02-08.05	184		LLE	0 986 486 061	19,05
	4.2	07.02-08.05	220		LLE	0 986 486 061	19,05

	2.5 TDI	05.00-08.05	120/132			0 986 486 548	22,2
	2.7 T	05.00-08.05	184/187			0 986 486 548	22,2
	4.2	07.02-08.05	220			0 986 486 548	22,2

	2.5 TDI	05.00-08.05	120/132			0 265 202 403 ^M	
	2.7 T	05.00-08.05	184/187			0 265 202 403 ^M	
	4.2	07.02-08.05	220			0 265 202 403 ^M	

	2.5 TDI	05.00-08.05	120/132		CFG	0 265 109 613 ^M	
	2.7 T	05.00-08.05	184/187		CFG	0 265 109 613 ^M	
	4.2	07.02-08.05	220		CFG	0 265 109 613 ^M	













	2.5 TDI	05.00-08.05	120/132			0 265 005 214	
	2.7 T	05.00-08.05	184/187			0 265 005 214	
	4.2	07.02-08.05	220			0 265 005 214	

A6 Allroad [4FH; C6]



	2.7 TDI	05.06-08.11	120/132/140		JBH	0 986 481 006	27
	3.0 TDI, TFSI	05.06-08.11	155/171/176/213		JBH	0 986 481 006	27
	3.2 FSI	05.06-10.08	188		JBH	0 986 481 006	27
	4.2 FSI	05.06-08.11	257		JBH	0 986 481 006	27

	2.7 TDI	05.06-10.08	120			0 265 005 692	
			132			0 265 005 692	
		10.08-08.11	120			0 265 005 777	
			140			0 265 005 777	
	3.0 TDI	05.06-05.07	155			0 265 005 692	
		05.06-10.08	171			0 265 005 692	
		10.08-08.11	155			0 265 005 777	
	3.0 TDI, TFSI	10.08-08.11	176/213			0 265 005 777	
	3.2 FSI	05.06-10.08	188			0 265 005 692	
	4.2 FSI	05.06-10.08	257	Fg.-Nr. →4F..8..250 000		0 265 005 692	
		11.08-08.11	257	Fg.-Nr. 4F..9..000 001→		0 265 005 777	

		S							
A6 Avant [4A5; C4]									
									
	1.8	ABO 10.95-10.97	92			JBH	0 986 480 911	23	
		ABS, 10.95-10.97	92				0 986 480 833	23,8	
		ASR							
	1.8 quattro	07.96-10.97	92				0 986 480 833	23,8	
	1.9 TDI	ABO 07.94-10.97	66			JBH	0 986 480 911	23	
		ABS, 07.95-10.97	66				0 986 480 833	23,8	
		ASR							
	2.0	ABO 06.94-10.97	79/85			JBH	0 986 480 911	23	
		ABS, 07.95-10.97	79/85				0 986 480 833	23,8	
		ASR							
	2.0, quattro	06.94-10.97	103				0 986 480 833	23,8	
	2.3	ABO 06.94-06.96	98			JBH	0 986 480 911	23	
		ABS, 07.95-06.96	98				0 986 480 833	23,8	
		ASR							
	2.3 quattro	08.94-06.95	98				0 986 480 833	23,8	
	2.4	ABO 07.96-10.97	110			JBH	0 986 480 911	23	
		ABS, 07.96-10.97	110				0 986 480 833	23,8	
		ASR							
	2.5 TDI	ABO 06.94-10.97	85/103			JBH	0 986 480 911	23	
		ABS, 07.95-07.96	103				0 986 480 833	23,8	
		ASR 07.95-10.97	85				0 986 480 833	23,8	
	2.5 TDI quattro	07.96-10.97	103				0 986 480 833	23,8	
	2.6	ABO 06.94-07.96	102/110			JBH	0 986 480 911	23	
		ABS, 07.95-06.96	110				0 986 480 833	23,8	
		ASR 07.95-07.96	102				0 986 480 833	23,8	
	2.6 quattro	06.94-06.96	102				0 986 480 833	23,8	
		06.94-10.97	110				0 986 480 833	23,8	
	2.8	ABO 06.94-10.97	120/128/142			JBH	0 986 480 911	23	
		ABS, 07.95-07.96	120				0 986 480 833	23,8	
		ASR	128				0 986 480 833	23,8	
		10.95-10.97	142				0 986 480 833	23,8	
	2.8 quattro	06.94-10.97	125-128				0 986 480 833	23,8	
		08.94-12.98	128				0 986 480 833	23,8	
		07.96-10.97	120				0 986 480 833	23,8	
			142				0 986 480 833	23,8	
	1.8, quattro	10.95-10.97	92			RLE	0 986 486 024	19,05	
	1.9 TDI	07.94-10.97	66			RLE	0 986 486 024	19,05	
	2.0, quattro	06.94-10.97	79/85/103			RLE	0 986 486 024	19,05	
	2.3, quattro	06.94-06.96	98			RLE	0 986 486 024	19,05	
	2.4	07.96-10.97	110			RLE	0 986 486 024	19,05	
	2.5 TDI, TDI quattro	06.94-10.97	85/103			RLE	0 986 486 024	19,05	
	2.6, quattro	06.94-10.97	102/110			RLE	0 986 486 024	19,05	
	2.8, quattro	06.94-12.98	120/125-128/142			RLE	0 986 486 024	19,05	
	1.8, quattro	10.95-10.97	92				0 986 486 532	22,2	
	1.9 TDI	07.94-10.97	66				0 986 486 532	22,2	
	2.0, quattro	06.94-10.97	79/85/103				0 986 486 532	22,2	
	2.3, quattro	06.94-06.96	98				0 986 486 532	22,2	
	2.4	07.96-10.97	110				0 986 486 532	22,2	
	2.5 TDI, TDI quattro	06.94-10.97	85/103				0 986 486 532	22,2	
	2.6, quattro	06.94-10.97	102/110				0 986 486 532	22,2	
	2.8, quattro	06.94-12.98	120/125-128/142				0 986 486 532	22,2	
	1.8	10.95-10.97	92			NIV	0 986 482 008 ^A		
	1.9 TDI	07.94-10.97	66			NIV	0 986 482 008 ^A		
	2.0	06.94-10.97	79/85			NIV	0 986 482 008 ^A		
	2.3	06.94-06.96	98			NIV	0 986 482 008 ^A		
	2.4	07.96-10.97	110			NIV	0 986 482 008 ^A		



		S								
	◀ AUDI A6 Avant [4A5; C4]									
	2.5 TDI	06.94-10.97	85/103			NW	0 986 482 008 ^A			
	2.6	06.94-07.96	102/110			NW	0 986 482 008 ^A			
	2.8	06.94-10.97	120/128/142			NW	0 986 482 008 ^A			
	1.8 quattro	07.96-10.97	92				0 265 218 022 ^J			
	2.0 quattro	06.94-04.95	103	Fg.-Nr. →4A..S..104 907			0 265 218 008 ^J			
		04.95-10.97	103	Fg.-Nr. 4A..S..104 908→			0 265 218 022 ^J			
	2.3 quattro	04.95-06.95	98	Fg.-Nr. 4A..S..104 908→			0 265 218 022 ^J			
	2.5 TDI quattro	07.96-10.97	103				0 265 218 022 ^J			
	2.6 quattro	06.94-04.95	102/110	Fg.-Nr. →4A..S..104 907			0 265 218 008 ^J			
		04.95-10.97	102/110	Fg.-Nr. 4A..S..104 908→			0 265 218 022 ^J			
	2.8 quattro	06.94-04.95	125-128	Fg.-Nr. →4A..S..104 907			0 265 218 008 ^J			
		04.95-12.98	125-128	Fg.-Nr. 4A..S..104 908→			0 265 218 022 ^J			
		07.96-10.97	120				0 265 218 022 ^J			
			142				0 265 218 022 ^J			
	1.8	10.95-10.97	92				0 265 108 005 ^H			
							0 265 109 002 ^K			
	1.8 quattro	07.96-10.97	92			GS	0 265 109 031 ^J			
	1.9 TDI	07.94-10.97	66				0 265 108 005 ^H			
						0 265 109 002 ^K				
	2.0	06.94-10.97	79/85				0 265 108 005 ^H			
						0 265 109 002 ^K				
		07.96-10.97	103				0 265 108 005 ^H			
							0 265 109 002 ^K			
	2.0 quattro	06.94-04.95	103	Fg.-Nr. →4A..S..100 000		AG	0 265 109 024 ^H			
				Fg.-Nr. →8D..S..105 000		GS	0 265 109 026 ^K			
		04.95-10.97	103	Fg.-Nr. 8D..S..105 001→			0 265 109 031 ^J			
	2.3	06.94-06.96	98				0 265 108 005 ^H			
						0 265 109 002 ^K				
	2.3 quattro	08.94-06.95	98			GS	0 265 109 031 ^J			
	2.4	07.96-10.97	110				0 265 108 005 ^H			
						0 265 109 002 ^K				
	2.5 TDI	06.94-10.97	85				0 265 108 005 ^H			
						0 265 109 002 ^K				
				10.94-07.96	103			0 265 108 005 ^H		
							0 265 109 002 ^K			
	2.5 TDI quattro	07.96-10.97	103			GS	0 265 109 031 ^J			
	2.6	06.94-07.96	102/110				0 265 108 005 ^H			
						0 265 109 002 ^K				
	2.6 quattro	06.94-04.95	102/110	Fg.-Nr. →4A..S..100 000		AG	0 265 109 024 ^H			
				Fg.-Nr. →8D..S..105 000		GS	0 265 109 026 ^K			
		04.95-10.97	102/110	Fg.-Nr. 8D..S..105 001→			0 265 109 031 ^J			
	2.8	06.94-07.96	120				0 265 108 005 ^H			
						0 265 109 002 ^K				
				09.94-07.96	128			0 265 108 005 ^H		
						0 265 109 002 ^K				
				10.95-10.97	142			0 265 108 005 ^H		
							0 265 109 002 ^K			
	2.8 quattro	06.94-04.95	125-128	Fg.-Nr. →4A..S..100 000		AG	0 265 109 024 ^H			
				Fg.-Nr. →8D..S..105 000		GS	0 265 109 026 ^K			
				08.94-04.95	128	Fg.-Nr. →4A..S..100 000		AG	0 265 109 024 ^H	
				Fg.-Nr. →8D..S..105 000		GS	0 265 109 026 ^K			
				04.95-10.97	125-128	Fg.-Nr. 8D..S..105 001→			0 265 109 031 ^J	
				04.95-12.98	128	Fg.-Nr. 8D..S..105 001→			0 265 109 031 ^J	
	07.96-10.97	120				0 265 109 031 ^J				
				142			GS	0 265 109 031 ^J		





A6 Avant [4B; C5]

	4.2 quattro	MFD	04.99-05.01	220		JBH,LLE	0 986 480 966	25,4
						JBH,RLE	0 986 480 989	25,4
		OFD	04.99-05.01	220		JBH,LLE	0 986 480 935	25,4
	4.2 quattro		04.99-05.01	220		LLE	0 986 486 054	19,05
	4.2 quattro		04.99-05.01	220			0 986 486 548	22,2
	4.2 quattro		04.99-05.01	220			0 265 202 403 ^M	
						CS2	0 265 220 410 ^E	
	4.2 quattro		04.99-06.99	220	Fg.-Nr. →8D..X..200 000	FMP,GRG	0 265 109 426 ^M	
			07.99-05.01	220	Fg.-Nr. 8D..Y..000 001→	FMP,GRG	0 265 109 462 ^M	
	4.2 quattro		04.99-05.01	220			0 265 005 214	
	4.2 quattro		04.99-05.01	220			0 265 005 303	











A6 Avant [4B5; C5]

	1.8	MFD	02.98-05.99	85/92	Fg.-Nr. →4B..X..130 000	JBH	0 986 480 974	23,8
			05.99-04.01	85/92	Fg.-Nr. 4B..X..130 001→	JBH,RLE	0 986 480 989	25,4
			06.99-04.01	85/92	Fg.-Nr. 4B..X..130 001→	JBH,LLE	0 986 480 966	25,4
		OFD	02.98-05.99	85/92	Fg.-Nr. →4B..X..130 000	JBH	0 986 480 890	23,81
			06.99-04.01	85/92	Fg.-Nr. 4B..X..130 001→	JBH,LLE	0 986 480 935	25,4
	1.8 T	MFD	02.98-05.99	110		JBH	0 986 480 974	23,8
	1.8 T quattro		02.98-10.00	132		JBH	0 986 480 974	23,8
			05.99-05.01	110	Fg.-Nr. 4B..X..130 001→	JBH,RLE	0 986 480 989	25,4
			06.99-05.01	110	Fg.-Nr. 4B..X..130 001→	JBH,LLE	0 986 480 966	25,4
			05.00-01.05	110		JBH,LLE	0 986 480 966	25,4
						JBH,RLE	0 986 480 989	25,4
		OFD	02.98-05.99	110		JBH	0 986 480 890	23,81
			02.98-10.00	132		JBH	0 986 480 890	23,81
			06.99-05.01	110	Fg.-Nr. 4B..X..130 001→	JBH,LLE	0 986 480 935	25,4
			05.00-01.05	110		JBH,LLE	0 986 480 935	25,4
	1.9 TDI		06.01-01.05	96		JBH GIR	0 986 481 046	25,4
		MFD	02.98-05.99	81	Fg.-Nr. →4B..X..130 000	JBH	0 986 480 974	23,8
			02.98-04.01	85		JBH,LLE	0 986 480 966	25,4
						JBH,RLE	0 986 480 989	25,4
			05.99-04.01	81	Fg.-Nr. 4B..X..130 001→	JBH,RLE	0 986 480 989	25,4
			06.99-04.01	81	Fg.-Nr. 4B..X..130 001→	JBH,LLE	0 986 480 966	25,4
		OFD	02.98-05.99	81	Fg.-Nr. →4B..X..130 000	JBH	0 986 480 890	23,81
			02.98-04.01	85		JBH,LLE	0 986 480 935	25,4
			06.99-04.01	81	Fg.-Nr. 4B..X..130 001→	JBH,LLE	0 986 480 935	25,4
	2.0		06.01-01.05	96		JBH GIR	0 986 481 046	25,4
	2.4	MFD	02.98-04.01	100/115		JBH	0 986 480 974	23,8
			05.99-05.00	120	Fg.-Nr. 4B..X..130 001→	JBH,RLE	0 986 480 989	25,4
			05.99-04.01	121	Fg.-Nr. 4B..X..130 001→	JBH,RLE	0 986 480 989	25,4
			06.99-05.00	120	Fg.-Nr. 4B..X..130 001→	JBH,LLE	0 986 480 966	25,4
			06.99-04.01	121	Fg.-Nr. 4B..X..130 001→	JBH,LLE	0 986 480 966	25,4
			06.00-04.01	120		JBH,LLE	0 986 480 966	25,4
						JBH,RLE	0 986 480 989	25,4











◀ AUDI A6 Avant [4B5; C5]										
2.4	OFD	02.98-04.01	100/115				JBH	0986 480 890	23,81	
		06.99-05.00	120	Fg.-Nr. 4B..X..130 001→			JBH,LLE	0986 480 935	25,4	
		06.99-04.01	121	Fg.-Nr. 4B..X..130 001→			JBH,LLE	0986 480 935	25,4	
		06.00-04.01	120				JBH,LLE	0986 480 935	25,4	
2.4		06.01-01.05	100/125			JBH	GIR 0986 481 046	25,4		
2.4 quattro	MFD	04.97-06.99	121				JBH	0986 480 974	23,8	
		02.98-01.99	120				JBH	0986 480 974	23,8	
		11.98-05.99	120	Fg.-Nr. →4B..X..130 000			JBH	0986 480 974	23,8	
		05.99-05.01	100/115	Fg.-Nr. 4B..X..130 001→			JBH,RLE	0986 480 989	25,4	
		06.99-05.01	100/115	Fg.-Nr. 4B..X..130 001→			JBH,LLE	0986 480 966	25,4	
		04.97-06.99	121				JBH	0986 480 890	23,81	
		02.98-01.99	120				JBH	0986 480 890	23,81	
2.4 quattro	OFD	11.98-05.99	120	Fg.-Nr. →4B..X..130 000			JBH	0986 480 890	23,81	
		06.99-05.01	100/115	Fg.-Nr. 4B..X..130 001→			JBH,LLE	0986 480 935	25,4	
		08.98-05.99	100/115	Fg.-Nr. →4B..X..130 000			JBH	0986 480 974	23,8	
		05.99-05.01	120	Fg.-Nr. 4B..X..130 001→			JBH,RLE	0986 480 989	25,4	
			121	Fg.-Nr. 4B..X..130 001→			JBH,RLE	0986 480 989	25,4	
		06.99-05.01	120	Fg.-Nr. 4B..X..130 001→			JBH,LLE	0986 480 966	25,4	
			121	Fg.-Nr. 4B..X..130 001→			JBH,LLE	0986 480 966	25,4	
2.4 quattro	MFD	06.00-05.01	121				JBH,LLE	0986 480 966	25,4	
							JBH,RLE	0986 480 989	25,4	
		08.98-05.99	100/115	Fg.-Nr. →4B..X..130 000			JBH	0986 480 890	23,81	
		06.99-05.01	120	Fg.-Nr. 4B..X..130 001→			JBH,LLE	0986 480 935	25,4	
			121	Fg.-Nr. 4B..X..130 001→			JBH,LLE	0986 480 935	25,4	
		06.00-05.01	121				JBH,LLE	0986 480 935	25,4	
		06.01-01.05	114/120/132				JBH	GIR 0986 481 046	25,4	
2.5 TDI		02.98-05.99	110	Fg.-Nr. →4B..X..130 000			JBH	0986 480 974	23,8	
2.5 TDI quattro	MFD	05.99-04.01	110	Fg.-Nr. 4B..X..130 001→			JBH,RLE	0986 480 989	25,4	
		06.99-04.01	110	Fg.-Nr. 4B..X..130 001→			JBH,LLE	0986 480 966	25,4	
		10.99-05.01	132				JBH,LLE	0986 480 966	25,4	
							JBH,RLE	0986 480 989	25,4	
		02.98-05.99	110	Fg.-Nr. →4B..X..130 000			JBH	0986 480 890	23,81	
2.5 TDI quattro	OFD	06.99-04.01	110	Fg.-Nr. 4B..X..130 001→			JBH,LLE	0986 480 935	25,4	
			132				JBH,LLE	0986 480 935	25,4	
		10.99-05.01	132				JBH,LLE	0986 480 935	25,4	
2.7 Biturbo		05.99-05.01	169	Fg.-Nr. 4B..X..130 001→			JBH,RLE	0986 480 989	25,4	
2.7 Biturbo	MFD	06.99-05.01	169	Fg.-Nr. 4B..X..130 001→			JBH,LLE	0986 480 966	25,4	
		06.99-05.01	169	Fg.-Nr. 4B..X..130 001→			JBH,LLE	0986 480 935	25,4	
2.7 Biturbo quattro		06.01-01.05	184				JBH	GIR 0986 481 046	25,4	
2.7 Biturbo quattro	MFD	05.99-08.00	169	Fg.-Nr. 4B..X..130 001→			JBH,RLE	0986 480 989	25,4	
		06.99-08.00	169	Fg.-Nr. 4B..X..130 001→			JBH,LLE	0986 480 966	25,4	
		09.00-05.01	169				JBH,LLE	0986 480 966	25,4	
							JBH,RLE	0986 480 989	25,4	
2.7 Biturbo quattro	OFD	06.99-08.00	169	Fg.-Nr. 4B..X..130 001→			JBH,LLE	0986 480 935	25,4	
		09.00-05.01	169				JBH,LLE	0986 480 935	25,4	
2.7 Biturbo		02.99-05.99	169	Fg.-Nr. →4B..X..130 000			JBH	0986 480 974	23,8	
2.7 Biturbo quattro		02.99-05.99	169	Fg.-Nr. →4B..X..130 000			JBH	0986 480 890	23,81	
2.8	MFD	05.99-04.01	142	Fg.-Nr. 4B..X..130 001→			JBH,RLE	0986 480 989	25,4	
		06.99-04.01	142	Fg.-Nr. 4B..X..130 001→			JBH,LLE	0986 480 966	25,4	
2.8		06.99-04.01	142	Fg.-Nr. 4B..X..130 001→			JBH,LLE	0986 480 935	25,4	
2.8		02.98-01.99	142				JBH	0986 480 974	23,8	
2.8 quattro	MFD	02.98-05.99	132	Fg.-Nr. →4B..X..130 000			JBH	0986 480 974	23,8	
		11.98-05.99	142	Fg.-Nr. →4B..X..130 000			JBH	0986 480 974	23,8	
		05.99-05.01	132	Fg.-Nr. 4B..X..130 001→			JBH,RLE	0986 480 989	25,4	
		06.99-05.01	132	Fg.-Nr. 4B..X..130 001→			JBH,LLE	0986 480 966	25,4	
		07.99-05.01	140				JBH,LLE	0986 480 966	25,4	
							JBH,RLE	0986 480 989	25,4	
		02.98-01.99	142				JBH	0986 480 890	23,81	
		02.98-05.99	132	Fg.-Nr. →4B..X..130 000			JBH	0986 480 890	23,81	
		11.98-05.99	142	Fg.-Nr. →4B..X..130 000			JBH	0986 480 890	23,81	
		06.99-05.01	132	Fg.-Nr. 4B..X..130 001→			JBH,LLE	0986 480 935	25,4	
2.8 quattro		07.99-05.01	140				JBH,LLE	0986 480 935	25,4	



		S								
2.8 quattro	MFD	05.99-05.01	142	Fg.-Nr. 4B..X..130 001→	JBH,RLE	0 986 480 989	25,4			
		06.99-05.01	142	Fg.-Nr. 4B..X..130 001→	JBH,LLE	0 986 480 966	25,4			
		06.00-05.01	142		JBH,LLE	0 986 480 966	25,4			
					JBH,RLE	0 986 480 989	25,4			
	OFD	06.99-05.01	142	Fg.-Nr. 4B..X..130 001→	JBH,LLE	0 986 480 935	25,4			
		06.00-05.01	142		JBH,LLE	0 986 480 935	25,4			
3.0, quattro		06.01-01.05	160/162		JBH GIR	0 986 481 046	25,4			
	1.8, T, T quattro	02.98-01.05	85/92/110/132		LLE	0 986 486 054	19,05			
	1.9 TDI	02.98-04.01	81/85		LLE	0 986 486 054	19,05			
		06.01-01.05	96		LLE	0 986 486 061	19,05			
	2.0	06.01-01.05	96		LLE	0 986 486 054	19,05			
	2.4	04.97-01.05	100/115/120/		LLE	0 986 486 054	19,05			
	2.4 quattro		121/125							
	2.5 TDI	02.98-04.01	110		LLE	0 986 486 054	19,05			
	2.5 TDI quattro	10.99-01.05	114/120/132		LLE	0 986 486 061	19,05			
	2.7 Biturbo quattro	06.01-01.05	184		LLE	0 986 486 061	19,05			
	2.7 Biturbo, Biturbo quattro	02.99-05.01	169		LLE	0 986 486 054	19,05			
	2.8, quattro	02.98-05.01	132/140/142		LLE	0 986 486 054	19,05			
	3.0, quattro	06.01-01.05	160/162		LLE	0 986 486 061	19,05			
		1.8, T, T quattro	02.98-01.05	85/92/110/			0 986 486 548	22,2		
		1.9 TDI	02.98-04.01	81/85			0 986 486 548	22,2		
			06.01-01.05	96			0 986 486 548	22,2		
06.01-01.05			96			0 986 486 548	22,2			
2.0		06.01-01.05	96			0 986 486 548	22,2			
2.4, quattro		04.97-01.05	100/115/120/121/125			0 986 486 548	22,2			
2.5 TDI, TDI quattro		02.98-01.05	110/114/120/132			0 986 486 548	22,2			
2.7 Biturbo, Biturbo quattro		02.99-01.05	169/184			0 986 486 548	22,2			
2.8, quattro		02.98-05.01	132/140/142			0 986 486 548	22,2			
3.0, quattro	06.01-01.05	160/162			0 986 486 548	22,2				
	1.8	02.98-04.01	85/92			0 265 202 403 ^M				
					CS2	0 265 220 407 ^E				
	1.8 T	02.98-01.99	110			CS2,EML	0 265 220 527 ^F			
		02.98-10.00	132			CS2	0 265 220 407 ^E			
		02.98-01.05	110			CS2	0 265 220 407 ^E			
		11.98-01.00	110	Fg.-Nr. →4B..Y..091 500		CS2	0 265 220 527 ^F			
	1.8 T quattro	02.98-01.99	110			CS2,EML	0 265 220 527 ^F			
		02.98-10.00	132			CS2	0 265 220 410 ^E			
		02.98-05.01	110			CS2	0 265 220 410 ^E			
		11.98-01.00	110	Fg.-Nr. →4B..Y..091 500		CS2	0 265 220 527 ^F			
		06.01-01.05	110				0 265 225 122 ^T			
		06.01-01.05	110				0 265 225 122 ^T			
	1.8 T	02.98-01.00	132	Fg.-Nr. →4B..Y..091 500		CS2	0 265 220 527 ^F			
	1.8 T quattro	02.98-10.00	132				0 265 202 403 ^M			
		02.98-01.05	110				0 265 202 403 ^M			
		02.98-01.00	81/85	Fg.-Nr. →4B..Y..091 500		CS2	0 265 220 527 ^F			
	1.9 TDI	02.98-04.01	81/85				0 265 202 403 ^M			
						CS2	0 265 220 407 ^E			
		06.01-01.05	96			CS2	0 265 225 125 ^T			
	2.0	06.01-01.05	96			CS2	0 265 225 125 ^T			
	2.4	04.97-04.01	120/121			CS2	0 265 220 407 ^E			
		02.98-01.99	100			CS2,EML	0 265 220 527 ^F			
		02.98-05.00	100				0 265 202 403 ^M			
						CS2	0 265 220 407 ^E			
		04.98-04.01	115			CS2	0 265 220 407 ^E			
						CS2,EML	0 265 220 527 ^F			
		06.01-01.05	100			CS2	0 265 225 125 ^T			
		125			CS2	0 265 225 125 ^T				
2.4, quattro		04.97-06.99	120/121			CS2,EML	0 265 220 527 ^F			
		04.97-05.01	120/121				0 265 202 403 ^M			
	04.98-05.01	115				0 265 202 403 ^M				
					CS2	0 265 220 413 ^F				



			S							
		◀ AUDI A6 Avant [4B5; C5]								
2.4, quattro	11.98-01.00	120/121	Fg.-Nr. →4B..Y..091 500	CS2,EML	0 265 220 527 ^F					
	11.98-05.01	120/121		CS2	0 265 220 413 ^F					
2.4 quattro	04.97-05.01	120/121		CS2	0 265 220 410 ^E					
	08.98-01.00	115	Fg.-Nr. →4B..Y..091 500	CS2,EML	0 265 220 527 ^F					
	08.98-05.01	115		CS2	0 265 220 410 ^E					
	06.01-01.05	125			0 265 225 122 ^T					
2.5 TDI	02.98-04.01	110		CS2	0 265 220 407 ^E					
	07.98-01.00	110	Fg.-Nr. 4B..W..170 000→ 4B..Y..091 500, 4B..X..000 001→	CS2	0 265 220 527 ^F					
	11.98-01.00	110	Fg.-Nr. →4B..Y..091 500	CS2	0 265 220 527 ^F					
	10.99-01.00	132	Fg.-Nr. →4B..Y..091 500	CS2	0 265 220 527 ^F					
	10.99-05.01	132			0 265 202 403 ^M					
					CS2	0 265 220 407 ^E				
	06.01-01.05	114/120 132			CS2	0 265 225 125 ^T				
2.5 TDI quattro	02.98-04.01	110		CS2	0 265 220 410 ^E					
	07.98-01.00	110	Fg.-Nr. 4B..W..170 000→ 4B..Y..091 500, 4B..X..000 001→	CS2	0 265 220 527 ^F					
	10.99-05.01	132		CS2	0 265 220 410 ^E					
	06.01-01.05	132			0 265 225 122 ^T					
2.5 TDI, TDI quattro	02.98-04.01	110			0 265 202 403 ^M					
2.7 Biturbo	02.99-01.00	169	Fg.-Nr. →4B..Y..091 500	CS2	0 265 220 527 ^F					
	02.99-05.01	169		CS2	0 265 220 407 ^E					
2.7 Biturbo quattro	02.99-05.01	169		CS2	0 265 220 410 ^E					
	06.01-01.05	184			0 265 225 122 ^T					
2.7 Biturbo, Biturbo quattro	02.99-05.01	169			0 265 202 403 ^M					
2.8	02.98-01.99	142		CS2,EML	0 265 220 527 ^F					
	02.98-05.00	132		CS2	0 265 220 407 ^E					
	02.98-04.01	142		CS2	0 265 220 407 ^E					
	11.98-01.00	142	Fg.-Nr. →4B..Y..091 500	CS2,EML	0 265 220 527 ^F					
	11.98-04.00	142	Fg.-Nr. →4B..Y..200 000	CS2,EML	0 265 220 527 ^F					
	07.99-04.01	140		CS2	0 265 220 407 ^E					
2.8	02.98-01.00	132	Fg.-Nr. →4B..Y..091 500	CS2,EML	0 265 220 527 ^F					
2.8 quattro	02.98-05.01	132			0 265 202 403 ^M					
		142			0 265 202 403 ^M					
	11.98-05.01	142		CS2	0 265 220 413 ^F					
	07.99-01.00	140	Fg.-Nr. →4B..Y..091 500	CS2,EML	0 265 220 527 ^F					
	07.99-05.01	140			0 265 202 403 ^M					
				CS2	0 265 220 413 ^F					
2.8 quattro	02.98-07.99	142		CS2,EML	0 265 220 527 ^F					
	02.98-05.01	142		CS2	0 265 220 410 ^E					
	04.98-05.01	132		CS2	0 265 220 410 ^E					
	01.99-01.00	142	Fg.-Nr. →4B..Y..091 500	CS2,EML	0 265 220 527 ^F					
	07.99-05.01	140		CS2	0 265 220 410 ^E					
3.0	06.01-01.05	160/162		CS2	0 265 225 125 ^T					
3.0 quattro	06.01-01.05	160/162			0 265 225 122 ^T					
1.8	02.98-04.01	85/92			0 265 109 463 ^M					
	1.8 T	02.98-10.00	132		0 265 109 463 ^M					
	02.98-01.05	110			0 265 109 463 ^M					
1.8 T quattro	02.98-05.99	110		FMP,GRG	0 265 109 426 ^M					
	02.98-06.99	132	Fg.-Nr. →8D..X..200 000	FMP,GRG	0 265 109 426 ^M					
	11.98-06.99	110	Fg.-Nr. →8D..X..200 000	FMP,GRG	0 265 109 426 ^M					
	07.99-10.00	132	Fg.-Nr. 8D..Y..000 001→	FMP,GRG	0 265 109 462 ^M					
	07.99-05.01	110	Fg.-Nr. 8D..Y..000 001→	FMP,GRG	0 265 109 462 ^M					
	05.00-05.01	110		FMP,GRG	0 265 109 462 ^M					
1.9 TDI	02.98-04.01	81/85			0 265 109 463 ^M					
	06.01-01.05	96			0 265 109 463 ^M					
2.0	06.01-01.05	96			0 265 109 463 ^M					
2.4	04.97-04.01	121			0 265 109 463 ^M					
	02.98-07.98	120			0 265 109 463 ^M					
	02.98-01.99	100			0 265 109 463 ^M					
	04.98-04.01	115			0 265 109 463 ^M					

		S								
2.4	11.98-04.01	120					0 265 109 463 ^M			
	02.99-05.00	100					0 265 109 463 ^M			
	06.01-01.05	100					0 265 109 463 ^M			
		125					0 265 109 463 ^M			
2.4 quattro	04.97-06.99	121				FMP,GRG	0 265 109 426 ^M			
	02.98-01.99	120				FMP,GRG	0 265 109 426 ^M			
	08.98-06.99	115	Fg.-Nr. →8D..X..200 000			FMP,GRG	0 265 109 426 ^M			
	11.98-06.99	120	Fg.-Nr. →8D..X..200 000			FMP,GRG	0 265 109 426 ^M			
	07.99-05.01	115	Fg.-Nr. 8D..Y..000 001→			FMP,GRG	0 265 109 462 ^M			
		120	Fg.-Nr. 8D..Y..000 001→			FMP,GRG	0 265 109 462 ^M			
	06.00-05.01	121	Fg.-Nr. 8D..Y..000 001→			FMP,GRG	0 265 109 462 ^M			
2.5 TDI	02.98-04.01	110					0 265 109 463 ^M			
	10.99-08.03	132					0 265 109 463 ^M			
	06.01-06.02	114					0 265 109 463 ^M			
2.5 TDI quattro	02.98-06.99	110	Fg.-Nr. →8D..X..200 000			FMP,GRG	0 265 109 426 ^M			
	11.98-04.01	110				FMP,GRG	0 265 109 426 ^M			
	07.99-05.00	110	Fg.-Nr. 8D..Y..000 001→			FMP,GRG	0 265 109 462 ^M			
	10.99-05.01	132				FMP,GRG	0 265 109 462 ^M			
2.7 Biturbo	02.99-05.01	169					0 265 109 463 ^M			
2.7 Biturbo quattro	02.99-06.99	169	Fg.-Nr. →8D..X..200 000			FMP,GRG	0 265 109 426 ^M			
	07.99-08.00	169	Fg.-Nr. 8D..Y..000 001→			FMP,GRG	0 265 109 462 ^M			
	09.00-05.01	169				FMP,GRG	0 265 109 462 ^M			
2.8	02.98-05.00	132					0 265 109 463 ^M			
	02.98-04.01	142					0 265 109 463 ^M			
	07.99-04.01	140					0 265 109 463 ^M			
2.8 quattro	02.98-07.99	142				FMP,GRG	0 265 109 426 ^M			
	04.98-06.99	132	Fg.-Nr. →8D..X..200 000			FMP,GRG	0 265 109 426 ^M			
	07.99-05.01	132	Fg.-Nr. 8D..Y..000 001→			FMP,GRG	0 265 109 462 ^M			
		142	Fg.-Nr. 8D..Y..000 001→			FMP,GRG	0 265 109 462 ^M			
	06.00-05.01	142				FMP,GRG	0 265 109 462 ^M			
3.0	06.01-01.05	162					0 265 109 463 ^M			
	1.8	02.98-04.01	85/92				0 265 005 214			
	1.8 T	02.98-10.00	132				0 265 005 214			
		02.98-01.05	110				0 265 005 214			
	1.8 T quattro	02.98-10.98	110	Fg.-Nr. →4B..X..026 000				0 265 005 207		
			132	Fg.-Nr. →4B..X..026 000				0 265 005 207		
		10.98-01.99	110	Fg.-Nr. 4B..X..026 001→				0 265 005 214		
		10.98-10.00	132	Fg.-Nr. 4B..X..026 001→				0 265 005 214		
		11.98-05.01	110					0 265 005 214		
		06.01-01.05	110					0 265 005 252		
	1.9 TDI	02.98-04.01	81/85					0 265 005 214		
		06.01-01.05	96					0 265 005 252		
	2.0	06.01-01.05	96					0 265 005 252		
	2.4	04.97-04.01	121					0 265 005 214		
		02.98-07.98	120					0 265 005 214		
		02.98-05.00	100					0 265 005 214		
04.98-04.01		115					0 265 005 214			
11.98-05.00		120					0 265 005 214			
06.00-04.01		120					0 265 005 252			
06.01-01.05		100					0 265 005 252			
06.01-01.05		125					0 265 005 252			
2.4 quattro	04.97-10.98	121	Fg.-Nr. →4B..X..026 000				0 265 005 207			
	02.98-10.98	120	Fg.-Nr. →4B..X..026 000				0 265 005 207			
	08.98-10.98	115	Fg.-Nr. →4B..X..026 000				0 265 005 207			
	10.98-01.99	120	Fg.-Nr. 4B..X..026 001→				0 265 005 214			
		121	Fg.-Nr. 4B..X..026 001→				0 265 005 214			
	10.98-05.01	115	Fg.-Nr. 4B..X..026 001→				0 265 005 214			
	11.98-05.01	120					0 265 005 214			
	121					0 265 005 214				
2.5 TDI	02.98-04.01	110					0 265 005 214			
	06.01-01.05	114/120					0 265 005 252			





AUDI A6 Avant [4B5; C5]						
2.5 TDI quattro	02.98-10.98	110	Fg.-Nr. →4B..X..026 000		0 265	005 207
	10.98-05.00	110	Fg.-Nr. 4B..X..026 001→		0 265	005 214
	11.98-04.01	110			0 265	005 214
2.5 TDI	10.99-05.01	132			0 265	005 214
2.5 TDI quattro	06.01-01.05	132			0 265	005 252
2.7 Biturbo	02.99-05.01	169			0 265	005 214
2.7 Biturbo quattro	02.99-08.00	169	Fg.-Nr. 4B..X..026 001→		0 265	005 214
	09.00-05.01	169			0 265	005 214
	06.01-01.05	184			0 265	005 252
2.8	02.98-05.00	132			0 265	005 214
	02.98-04.01	142			0 265	005 214
2.8, quattro	07.99-05.01	140			0 265	005 214
2.8 quattro	02.98-10.98	142	Fg.-Nr. →4B..X..026 000		0 265	005 207
	04.98-10.98	132	Fg.-Nr. →4B..X..026 000		0 265	005 207
	10.98-01.99	142	Fg.-Nr. 4B..X..026 001→		0 265	005 214
	10.98-05.01	132	Fg.-Nr. 4B..X..026 001→		0 265	005 214
	11.98-05.01	142			0 265	005 214
	06.00-05.01	142			0 265	005 252
3.0, quattro	06.01-01.05	160/162			0 265	005 252
1.8,T, T quattro	11.98-01.05	92/110			0 265	005 303
	02.98-04.01	81/85			0 265	005 303
1.9 TDI	06.01-01.05	96			0 265	005 303
	06.01-01.05	96			0 265	005 303
2.0	06.01-01.05	96			0 265	005 303
2.4, quattro	04.98-01.05	100/115/120/121/125			0 265	005 303
2.5 TDI, TDI quattro	10.99-01.05	114/120/132			0 265	005 303
2.7 Biturbo, Biturbo quattro	02.99-01.05	169/184			0 265	005 303
2.8, quattro	11.98-05.01	140/142			0 265	005 303
3.0, quattro	06.01-01.05	160/162			0 265	005 303

A6 Avant [4B5;C5]

2.4	MFD	06.00-04.01	121	JBH,LLE	0 986	480 966	25,4
				JBH,RLE	0 986	480 989	25,4
	OFD	06.00-04.01	121	JBH,LLE	0 986	480 935	25,4
2.4		06.00-04.01	121	LLE	0 986	486 054	19,05
2.4		06.00-04.01	121		0 986	486 548	22,2
2.4		06.00-04.01	121		0 265	202 403^M	
				CS2	0 265	220 410^E	
2.4		06.00-04.01	121	FMP,GRG	0 265	109 462^M	
2.4		06.00-04.01	121		0 265	005 214	
2.4		06.00-04.01	121		0 265	005 303	

A6 Avant [4B6; C5]

4.2 quattro	MFD	06.01-01.05	220	JBH,LLE	0 986	480 966	25,4
				JBH,RLE	0 986	480 989	25,4
	OFD	06.01-01.05	220	JBH,LLE	0 986	480 935	25,4

		S							
	4.2 quattro	06.01-01.05	220			LLE	0 986 486 061	19,05	
	4.2 quattro	06.01-01.05	220				0 986 486 548	22,2	
	4.2 quattro	06.01-01.05	220				0 265 225 122 ^T		
	4.2 quattro	06.01-01.05	220				0 265 005 252		
	4.2 quattro	06.01-01.05	220				0 265 005 303		
A6 Avant [4F5; C6]									
	2.0 TDI, TDI e, TFSI	06.05-08.11	89/100/103/120/125			JBH	0 986 481 006	27	
	2.4	03.05-10.08	130			JBH	0 986 481 006	27	
	2.7 TDI, TDI quattro	03.05-08.11	120/132/140			JBH	0 986 481 006	27	
	2.8 FSI, FSI quattro	10.08-08.11	140/162			JBH	0 986 481 006	27	
	3.0	03.05-05.06	160			JBH	0 986 481 006	27	
	3.0 TDI quattro	10.08-08.11	155			JBH	0 986 481 006	27	
	3.0 TDI quattro, TFSI quattro	10.08-08.11	176/213/220			JBH	0 986 481 006	27	
	3.2 FSI, FSI quattro	03.05-10.08	188			JBH	0 986 481 006	27	
	4.2 FSI quattro	06.06-08.11	257			FMS,JBH	0 986 481 046	25,4	
						FMS,JBH	0 986 481 006	27	
	2.0 TDI	06.05-11.05	100/103				0 265 234 262 ^T		
				PR-Code 8T4			0 265 234 208 ^B		
		06.05-05.06	100/103	Fg.-Nr. →4F..6..250 000	GBM		0 265 234 208 ^T		
					GBM		0 265 234 262 ^T		
		09.05-05.06	89	Fg.-Nr. →4F..6..250 000	GBM		0 265 234 262 ^T		
		09.05-06.06	89		GBM		0 265 234 208 ^T		
		06.06-10.08	100/103	Fg.-Nr. 4F..7..000 001→			0 265 235 102 ^T		
	2.0 TFSI	06.05-05.06	125	Fg.-Nr. →4F..6..250 000	GES		0 265 234 208 ^B		
					GES		0 265 234 262 ^T		
		06.06-09.08	125	Fg.-Nr. 4F..7..000 001→			0 265 235 102 ^T		
	2.4	03.05-05.06	130	Fg.-Nr. →4F..6..250 000	GBM		0 265 234 208 ^T		
					GBM		0 265 234 262 ^T		
		06.06-10.08	130	Fg.-Nr. 4F..7..000 001→			0 265 235 102 ^T		
	2.4 quattro	03.05-05.06	130	Fg.-Nr. →4F..6..250 000	GBM		0 265 234 211 ^T		
					GBM		0 265 234 265 ^T		
		06.06-10.08	130	Fg.-Nr. 4F..7..000 001→			0 265 235 105 ^T		
	2.7 TDI	03.05-05.06	120		GBM		0 265 234 208 ^T		
					GBM		0 265 234 262 ^T		
			132	Fg.-Nr. →4F..6..250 000	GBM		0 265 234 208 ^T		
					GBM		0 265 234 262 ^T		
		06.06-10.08	132	Fg.-Nr. 4F..7..000 001→			0 265 235 102 ^T		
	2.7 TDI quattro	06.05-05.06	120	Fg.-Nr. →4F..6..250 000	GBM		0 265 234 211 ^T		
					GBM		0 265 234 265 ^T		
			132	Fg.-Nr. →4F..6..250 000	GBM		0 265 234 211 ^T		
					GBM		0 265 234 265 ^T		
		06.06-10.08	120	Fg.-Nr. 4F..7..000 001→			0 265 235 105 ^T		
			132	Fg.-Nr. 4F..7..000 001→			0 265 235 105 ^T		
	3.0	03.05-05.06	160				0 265 234 262 ^T		
	3.0 quattro	03.05-05.06	160		GBM		0 265 234 211 ^T		
					GBM		0 265 234 265 ^T		

















◀ AUDI A6 Avant [4F5; C6]							
3.0 TDI quattro	03.05-05.06	155	Fg.-Nr. →4F..6..250 000	GBM	0 265 234 211 ^T		
			Fg.-Nr. 4F..5..090 001→ 4F..6..250 000	GBM	0 265 234 265 ^T		
		165		GBM	0 265 234 211 ^T		
				GBM	0 265 234 265 ^T		
	06.06-10.08	155	Fg.-Nr. 4F..7..000 001→		0 265 235 105 ^T		
		171			0 265 235 105 ^T		
3.2 FSI	03.05-05.06	188	Fg.-Nr. →4F..6..250 000	GBM	0 265 234 208 ^T		
				GBM	0 265 234 262 ^T		
	06.06-10.08	188	Fg.-Nr. 4F..7..000 001→		0 265 235 102 ^T		
3.2 FSI quattro	03.05-05.06	188	Fg.-Nr. →4F..6..250 000	GBM	0 265 234 211 ^T		
			Fg.-Nr. 4F..5..090 001→ 4F..6..250 000	GBM	0 265 234 265 ^T		
	06.06-10.08	188	Fg.-Nr. 4F..7..000 001→		0 265 235 105 ^T		
4.2 FSI quattro	06.06-09.08	257	Fg.-Nr. 4F..7..000 001→		0 265 235 105 ^T		
4.2 quattro	03.05-05.06	246		GBM	0 265 234 211 ^T		
				GBM	0 265 234 265 ^T		
2.0 TDI	06.05-11.05	100			0 265 005 601		
		103			0 265 005 601		
	06.05-05.06	100	Fg.-Nr. →4F..6..250 000		0 265 005 601		
		103	Fg.-Nr. →4F..6..250 000		0 265 005 601		
	09.05-06.06	89			0 265 005 601		
	06.06-10.08	100	Fg.-Nr. 4F..7..000 001→		0 265 005 619		
		103	Fg.-Nr. 4F..7..000 001→		0 265 005 619		
	04.09-08.11	120			0 265 005 777		
2.0 TDI e	10.08-03.11	100			0 265 005 777		
2.0 TDI, TFSI	10.08-08.11	125			0 265 005 777		
2.0 TFSI	06.05-05.06	125	Fg.-Nr. →4F..6..250 000		0 265 005 692		
		125	Fg.-Nr. 4F..7..000 001→		0 265 005 619		
2.4	03.05-05.06	130	Fg.-Nr. →4F..6..250 000		0 265 005 601		
2.4 quattro	06.06-10.08	130	Fg.-Nr. 4F..7..000 001→		0 265 005 619		
2.7 TDI	03.05-05.06	120			0 265 005 601		
2.7 TDI quattro	06.05-05.06	120	Fg.-Nr. →4F..6..250 000		0 265 005 601		
		120	Fg.-Nr. 4F..7..000 001→		0 265 005 619		
2.7 TDI	03.05-05.06	132	Fg.-Nr. →4F..6..250 000		0 265 005 601		
2.7 TDI quattro	06.06-10.08	132	Fg.-Nr. 4F..7..000 001→		0 265 005 619		
		120			0 265 005 777		
		140			0 265 005 777		
2.8 FSI, FSI quattro	10.08-08.11	140/162			0 265 005 777		
3.0, quattro, TDI quattro	03.05-05.06	160/165			0 265 005 601		
3.0 TDI quattro	03.05-05.06	155	Fg.-Nr. →4F..6..250 000		0 265 005 601		
		06.06-10.08	155	Fg.-Nr. 4F..7..000 001→		0 265 005 619	
			171			0 265 005 619	
		10.08-08.11	155			0 265 005 777	
3.0 TDI quattro, TFSI quattro	10.08-08.11	176/213/220			0 265 005 777		
3.2 FSI	03.05-05.06	188	Fg.-Nr. →4F..6..250 000		0 265 005 692		
3.2 FSI quattro	06.06-10.08	188	Fg.-Nr. 4F..7..000 001→		0 265 005 619		
4.2 FSI quattro	06.06-05.08	257	Fg.-Nr. →4F..8..152 360		0 265 005 619		
		257	Fg.-Nr. 4F..8..152 361→		0 265 005 777		
4.2 quattro	03.05-05.06	246			0 265 005 601		











A6 [4A2; C4]

1.8	ABO	06.94-10.97	92		JBH	0 986 480 911	23
	ABS, ASR	07.95-10.97	92			0 986 480 833	23,8
1.8 quattro		10.95-10.97	92			0 986 480 833	23,8
1.9 TDI	ABO	06.94-10.97	66		JBH	0 986 480 911	23
	ABS, ASR	07.95-10.97	66			0 986 480 833	23,8

		S							
2.0	ABO	06.94-10.97	74/79/85/103			JBH	0 986 480 911	23	
	ABS,	07.95-10.97	74/79/85				0 986 480 833	23,8	
	ASR		103				0 986 480 833	23,8	
2.0 quattro		06.94-10.97	103				0 986 480 833	23,8	
2.3	ABO	06.94-10.97	98			JBH	0 986 480 911	23	
	ABS,	07.95-10.97	98				0 986 480 833	23,8	
	ASR								
2.3 quattro		08.94-07.95	98				0 986 480 833	23,8	
2.4	ABO	07.95-10.97	110			JBH	0 986 480 911	23	
	ABS,	07.95-10.97	110				0 986 480 833	23,8	
	ASR								
2.5 TDI	ABO	06.94-10.97	85/103			JBH	0 986 480 911	23	
	ABS,	07.95-10.97	85				0 986 480 833	23,8	
	ASR		103				0 986 480 833	23,8	
2.5 TDI quattro		07.95-10.97	103				0 986 480 833	23,8	
2.6	ABO	06.94-10.97	102/110			JBH	0 986 480 911	23	
	ABS,	07.95-10.97	102				0 986 480 833	23,8	
	ASR		110				0 986 480 833	23,8	
2.6 quattro		06.94-10.97	102				0 986 480 833	23,8	
			110				0 986 480 833	23,8	
2.8	ABO	06.94-10.97	128			JBH	0 986 480 911	23	
		09.94-10.97	120			JBH	0 986 480 911	23	
		10.95-10.97	142			JBH	0 986 480 911	23	
	ABS,	07.95-10.97	120				0 986 480 833	23,8	
	ASR		128				0 986 480 833	23,8	
		10.95-10.97	142				0 986 480 833	23,8	
2.8 i		06.94-12.97	128				0 986 480 829	23,8	
	ABS	06.94-12.97	128			JBH	0 986 480 911	23	
2.8 quattro		06.94-10.97	128				0 986 480 833	23,8	
		07.95-10.97	120				0 986 480 833	23,8	
		10.95-10.97	142				0 986 480 833	23,8	
	1.8, quattro	06.94-10.97	92			RLE	0 986 486 024	19,05	
	1.9 TDI	06.94-10.97	66			RLE	0 986 486 024	19,05	
	2.0, quattro	06.94-10.97	74/79/85/103			RLE	0 986 486 024	19,05	
	2.3, quattro	06.94-10.97	98			RLE	0 986 486 024	19,05	
	2.4	07.95-10.97	110			RLE	0 986 486 024	19,05	
	2.5 TDI, TDI quattro	06.94-10.97	85/103			RLE	0 986 486 024	19,05	
	2.6, quattro	06.94-10.97	102/110			RLE	0 986 486 024	19,05	
	2.8, quattro	06.94-10.97	120/128/142			RLE	0 986 486 024	19,05	
	1.8, quattro	06.94-10.97	92				0 986 486 532	22,2	
	1.9 TDI	06.94-10.97	66				0 986 486 532	22,2	
	2.0, quattro	06.94-10.97	74/79/85/103				0 986 486 532	22,2	
	2.3, quattro	06.94-10.97	98				0 986 486 532	22,2	
	2.4	07.95-10.97	110				0 986 486 532	22,2	
	2.5 TDI, TDI quattro	06.94-10.97	85/103				0 986 486 532	22,2	
	2.6, quattro	06.94-10.97	102/110				0 986 486 532	22,2	
	2.8, quattro	06.94-10.97	120/128/142				0 986 486 532	22,2	
	1.8	06.94-10.97	92			NIV	0 986 482 008 ^A		
	1.9 TDI	06.94-10.97	66			NIV	0 986 482 008 ^A		
	2.0	06.94-10.97	74/79/85/103			NIV	0 986 482 008 ^A		
	2.3	06.94-10.97	98			NIV	0 986 482 008 ^A		
	2.4	07.95-10.97	110			NIV	0 986 482 008 ^A		
	2.5 TDI	06.94-10.97	85/103			NIV	0 986 482 008 ^A		
	2.6	06.94-10.97	102/110			NIV	0 986 482 008 ^A		
	2.8	06.94-10.97	120/128/142			NIV	0 986 482 008 ^A		
	1.8	06.94-10.97	92				0 265 216 006 ^H		
	1.8 quattro	10.95-10.97	92				0 265 218 022 ^J		
	1.9 TDI	06.94-10.97	66				0 265 216 006 ^H		



		S							
◀ AUDI A6 [4A2; C4]									
2.0		06.94-10.97	74/79/85				0 265 216 006 ^H		
			103				0 265 216 006 ^H		
2.0 quattro		06.94-04.95	103	Fg.-Nr. →4A..S..104 907			0 265 218 008 ^J		
		04.95-10.97	103	Fg.-Nr. 4A..S..104 908→			0 265 218 022 ^J		
2.3		06.94-10.97	98				0 265 216 006 ^H		
2.3 quattro		08.94-04.95	98	Fg.-Nr. →4A..S..104 907			0 265 218 008 ^J		
		04.95-07.95	98	Fg.-Nr. 4A..S..104 908→			0 265 218 022 ^J		
2.4		07.95-10.97	110				0 265 216 006 ^H		
2.5 TDI		06.94-10.97	85				0 265 216 006 ^H		
		10.94-10.97	103				0 265 216 006 ^H		
2.5 TDI quattro		07.95-10.97	103				0 265 218 022 ^J		
2.6		06.94-10.97	102/110				0 265 216 006 ^H		
2.6 quattro		06.94-04.95	102/110	Fg.-Nr. →4A..S..104 907			0 265 218 008 ^J		
		04.95-10.97	102/110	Fg.-Nr. 4A..S..104 908→			0 265 218 022 ^J		
2.8		06.94-10.97	128				0 265 216 006 ^H		
		09.94-10.97	120				0 265 216 006 ^H		
		10.95-10.97	142				0 265 216 006 ^H		
2.8 quattro		06.94-04.95	128	Fg.-Nr. →4A..S..104 907			0 265 218 008 ^J		
		04.95-10.97	128	Fg.-Nr. 4A..S..104 908→			0 265 218 022 ^J		
		07.95-10.97	120				0 265 218 022 ^J		
		10.95-10.97	142				0 265 218 022 ^J		
1.8		06.94-10.97	92				0 265 108 005 ^H		
							0 265 109 002 ^K		
1.8 quattro		10.95-10.97	92		GS		0 265 109 031 ^J		
1.9 TDI		06.94-10.97	66				0 265 108 005 ^H		
							0 265 109 002 ^K		
2.0		06.94-10.97	74/79/85				0 265 108 005 ^H		
			103				0 265 109 002 ^K		
							0 265 108 005 ^H		
							0 265 109 002 ^K		
2.0 quattro		06.94-04.95	103	Fg.-Nr. →4A..S..100 000	AG		0 265 109 024 ^H		
				Fg.-Nr. →8D..S..105 000	GS		0 265 109 026 ^K		
		04.95-10.97	103	Fg.-Nr. 8D..S..105 001→			0 265 109 031 ^J		
2.3		06.94-10.97	98				0 265 108 005 ^H		
							0 265 109 002 ^K		
2.3 quattro		08.94-04.95	98	Fg.-Nr. →4A..S..100 000	AG		0 265 109 024 ^H		
				Fg.-Nr. →8D..S..105 000	GS		0 265 109 026 ^K		
		04.95-07.95	98	Fg.-Nr. 8D..S..105 001→			0 265 109 031 ^J		
2.4		07.95-10.97	110				0 265 108 005 ^H		
							0 265 109 002 ^K		
2.5 TDI		06.94-10.97	85				0 265 108 005 ^H		
							0 265 109 002 ^K		
		10.94-10.97	103				0 265 108 005 ^H		
							0 265 109 002 ^K		
2.5 TDI quattro		07.95-10.97	103		GS		0 265 109 031 ^J		
2.6		06.94-10.97	102/110				0 265 108 005 ^H		
							0 265 109 002 ^K		
2.6 quattro		06.94-04.95	102/110	Fg.-Nr. →4A..S..100 000	AG		0 265 109 024 ^H		
				Fg.-Nr. →8D..S..105 000	GS		0 265 109 026 ^K		
		04.95-10.97	102/110	Fg.-Nr. 8D..S..105 001→			0 265 109 031 ^J		
2.8		06.94-10.97	128				0 265 108 005 ^H		
							0 265 109 002 ^K		
		09.94-10.97	120				0 265 108 005 ^H		
							0 265 109 002 ^K		
		10.95-10.97	142				0 265 108 005 ^H		
							0 265 109 002 ^K		
2.8 i		06.94-12.97	128		KZA		0 265 108 005 ^H		
2.8 quattro		06.94-04.95	128	Fg.-Nr. →4A..S..100 000	AG		0 265 109 024 ^H		
				Fg.-Nr. →8D..S..105 000	GS		0 265 109 026 ^K		
		04.95-10.97	128	Fg.-Nr. 8D..S..105 001→			0 265 109 031 ^J		
		07.95-10.97	120		GS		0 265 109 031 ^J		
		10.95-10.97	142		GS		0 265 109 031 ^J		

		S							
A6 [4B2; C5]									
									
	1.8	MFD	05.97-05.99	85/92	Fg.-Nr. →4B..X..130 000	JBH	0 986 480 974		23,8
			05.99-04.01	85/92	Fg.-Nr. 4B..X..130 001→	JBH,RLE	0 986 480 989		25,4
			06.99-04.01	85/92	Fg.-Nr. 4B..X..130 001→	JBH,LLE	0 986 480 966		25,4
		OFD	05.97-05.99	85/92	Fg.-Nr. →4B..X..130 000	JBH	0 986 480 890		23,81
			06.99-04.01	85/92	Fg.-Nr. 4B..X..130 001→	JBH,LLE	0 986 480 935		25,4
	1.8 T, T quattro	MFD	04.97-05.99	110		JBH	0 986 480 974		23,8
			06.97-10.00	132		JBH	0 986 480 974		23,8
			05.99-05.01	110	Fg.-Nr. 4B..X..130 001→	JBH,RLE	0 986 480 989		25,4
			06.99-05.01	110	Fg.-Nr. 4B..X..130 001→	JBH,LLE	0 986 480 966		25,4
			05.00-05.04	110		JBH,LLE	0 986 480 966		25,4
						JBH,RLE	0 986 480 989		25,4
		OFD	04.97-05.99	110		JBH	0 986 480 890		23,81
			06.97-10.00	132		JBH	0 986 480 890		23,81
			06.99-05.01	110	Fg.-Nr. 4B..X..130 001→	JBH,LLE	0 986 480 935		25,4
			05.00-05.04	110		JBH,LLE	0 986 480 935		25,4
	1.9 TDI		06.01-05.04	96		JBH GIR	0 986 481 046		25,4
		MFD	04.97-05.99	81	Fg.-Nr. →4B..X..130 000	JBH	0 986 480 974		23,8
			05.99-08.99	81	Fg.-Nr. 4B..X..130 001→	JBH,RLE	0 986 480 989		25,4
			05.99-04.01	85		JBH,LLE	0 986 480 966		25,4
						JBH,RLE	0 986 480 989		25,4
			06.99-08.99	81	Fg.-Nr. 4B..X..130 001→	JBH,LLE	0 986 480 966		25,4
			08.99-10.00	81		JBH,LLE	0 986 480 966		25,4
						JBH,RLE	0 986 480 989		25,4
		OFD	04.97-05.99	81	Fg.-Nr. →4B..X..130 000	JBH	0 986 480 890		23,81
			05.99-04.01	85		JBH,LLE	0 986 480 935		25,4
			06.99-08.99	81	Fg.-Nr. 4B..X..130 001→	JBH,LLE	0 986 480 935		25,4
			08.99-10.00	81		JBH,LLE	0 986 480 935		25,4
	2.0		06.01-05.04	96		JBH GIR	0 986 481 046		25,4
	2.4	MFD	08.97-01.99	100		JBH	0 986 480 974		23,8
			02.99-05.99	100	Fg.-Nr. →4B..X..130 000	JBH	0 986 480 974		23,8
			05.99-05.00	100	Fg.-Nr. 4B..X..130 001→	JBH,RLE	0 986 480 989		25,4
				120	Fg.-Nr. 4B..X..130 001→	JBH,RLE	0 986 480 989		25,4
			06.99-05.00	100	Fg.-Nr. 4B..X..130 001→	JBH,LLE	0 986 480 966		25,4
			06.01-05.04	120		JBH,RLE	0 986 480 989		25,4
		OFD	08.97-01.99	100		JBH	0 986 480 890		23,81
			02.99-05.99	100	Fg.-Nr. →4B..X..130 000	JBH	0 986 480 890		23,81
			06.99-05.00	100	Fg.-Nr. 4B..X..130 001→	JBH,LLE	0 986 480 935		25,4
	2.4		06.01-05.04	100/120/125		JBH GIR	0 986 481 046		25,4
	2.4 quattro	MFD	04.97-01.99	120		JBH	0 986 480 974		23,8
			04.97-06.99	121		JBH	0 986 480 974		23,8
			04.98-05.99	115	Fg.-Nr. →4B..X..130 000	JBH	0 986 480 974		23,8
			11.98-05.99	120	Fg.-Nr. →4B..X..130 000	JBH	0 986 480 974		23,8
			05.99-04.01	115	Fg.-Nr. 4B..X..130 001→	JBH,RLE	0 986 480 989		25,4
			05.99-09.01	121	Fg.-Nr. 4B..X..130 001→	JBH,RLE	0 986 480 989		25,4
			06.99-05.00	120	Fg.-Nr. 4B..X..130 001→	JBH,LLE	0 986 480 966		25,4
			06.99-04.01	115	Fg.-Nr. 4B..X..130 001→	JBH,LLE	0 986 480 966		25,4
			06.99-09.01	121	Fg.-Nr. 4B..X..130 001→	JBH,LLE	0 986 480 966		25,4
			06.00-05.01	121		JBH,LLE	0 986 480 966		25,4
						JBH,RLE	0 986 480 989		25,4
		OFD	04.97-01.99	120		JBH	0 986 480 890		23,81
			04.97-06.99	121		JBH	0 986 480 890		23,81
			04.98-05.99	115	Fg.-Nr. →4B..X..130 000	JBH	0 986 480 890		23,81
			11.98-05.99	120	Fg.-Nr. →4B..X..130 000	JBH	0 986 480 890		23,81
			06.99-05.00	120	Fg.-Nr. 4B..X..130 001→	JBH,LLE	0 986 480 935		25,4
			06.99-04.01	115	Fg.-Nr. 4B..X..130 001→	JBH,LLE	0 986 480 935		25,4
			06.99-09.01	121	Fg.-Nr. 4B..X..130 001→	JBH,LLE	0 986 480 935		25,4
			06.00-05.01	121		JBH,LLE	0 986 480 935		25,4
	2.4 quattro	MFD	05.99-05.00	120	Fg.-Nr. 4B..X..130 001→	JBH,RLE	0 986 480 989		25,4













AUDI A6 [4B2; C5]

2.5 TDI		06.01-05.04	114/120/132		JBH	GIR	0986 481 046	25,4	
2.5 TDI quattro	MFD	04.97-05.99	110	Fg.-Nr. →4B..X..130 000	JBH		0986 480 974	23,8	
		05.99-04.01	110	Fg.-Nr. 4B..X..130 001→	JBH,RLE		0986 480 989	25,4	
		06.99-04.01	110	Fg.-Nr. 4B..X..130 001→	JBH,LLE		0986 480 966	25,4	
		10.99-05.01	132		JBH,LLE		0986 480 966	25,4	
					JBH,RLE		0986 480 989	25,4	
		OFD	04.97-05.99	110	Fg.-Nr. →4B..X..130 000	JBH		0986 480 890	23,81
		06.99-04.01	110	Fg.-Nr. 4B..X..130 001→	JBH,LLE		0986 480 935	25,4	
		10.99-05.01	132		JBH,LLE		0986 480 935	25,4	
2.7 Biturbo	MFD	05.99-05.01	169	Fg.-Nr. 4B..X..130 001→	JBH,RLE		0986 480 989	25,4	
		06.99-05.01	169	Fg.-Nr. 4B..X..130 001→	JBH,LLE		0986 480 966	25,4	
	OFD	06.99-05.01	169	Fg.-Nr. 4B..X..130 001→	JBH,LLE		0986 480 935	25,4	
2.7 Biturbo quattro		06.01-05.04	184		JBH	GIR	0986 481 046	25,4	
	MFD	05.99-08.00	169	Fg.-Nr. 4B..X..130 001→	JBH,RLE		0986 480 989	25,4	
		06.99-08.00	169	Fg.-Nr. 4B..X..130 001→	JBH,LLE		0986 480 966	25,4	
		09.00-05.01	169		JBH,LLE		0986 480 966	25,4	
					JBH,RLE		0986 480 989	25,4	
		OFD	06.99-08.00	169	Fg.-Nr. 4B..X..130 001→	JBH,LLE		0986 480 935	25,4
		09.00-05.01	169		JBH,LLE		0986 480 935	25,4	
2.7 Biturbo	MFD	10.97-05.99	169	Fg.-Nr. →4B..X..130 000	JBH		0986 480 974	23,8	
2.7 Biturbo quattro	OFD	10.97-05.99	169	Fg.-Nr. →4B..X..130 000	JBH		0986 480 890	23,81	
2.8	MFD	04.97-01.99	142		JBH		0986 480 974	23,8	
2.8 quattro		10.97-05.99	132	Fg.-Nr. →4B..X..130 000	JBH		0986 480 974	23,8	
		11.98-05.99	142	Fg.-Nr. →4B..X..130 000	JBH		0986 480 974	23,8	
		05.99-05.00	132	Fg.-Nr. 4B..X..130 001→	JBH,RLE		0986 480 989	25,4	
		05.99-05.01	142	Fg.-Nr. 4B..X..130 001→	JBH,RLE		0986 480 989	25,4	
		06.99-05.00	132	Fg.-Nr. 4B..X..130 001→	JBH,LLE		0986 480 966	25,4	
		06.99-05.01	142	Fg.-Nr. 4B..X..130 001→	JBH,LLE		0986 480 966	25,4	
		07.99-05.01	140		JBH,LLE		0986 480 966	25,4	
					JBH,RLE		0986 480 989	25,4	
		06.00-05.01	142		JBH,LLE		0986 480 966	25,4	
					JBH,RLE		0986 480 989	25,4	
		OFD	04.97-01.99	142		JBH		0986 480 890	23,81
			10.97-05.99	132	Fg.-Nr. →4B..X..130 000	JBH		0986 480 890	23,81
			11.98-05.99	142	Fg.-Nr. →4B..X..130 000	JBH		0986 480 890	23,81
			06.99-05.00	132	Fg.-Nr. 4B..X..130 001→	JBH,LLE		0986 480 935	25,4
		06.99-05.01	142	Fg.-Nr. 4B..X..130 001→	JBH,LLE		0986 480 935	25,4	
		07.99-05.01	140		JBH,LLE		0986 480 935	25,4	
		06.00-05.01	142		JBH,LLE		0986 480 935	25,4	
3.0, quattro		06.01-08.04	160/162		JBH	GIR	0986 481 046	25,4	
3.0									

	1.8, T, T quattro	04.97-05.04	85/92/110/132		LLE		0986 486 054	19,05
	1.9 TDI	04.97-05.97	81	Fg.-Nr. →4B..W..019 484	LLE,WMT		0986 486 083	19
		04.97-08.99	81		LLE,WKU		0986 486 054	19,05
		05.99-04.01	85				0986 486 054	19,05
		08.99-10.00	81		LLE		0986 486 054	19,05
		06.01-05.04	96		LLE		0986 486 061	19,05
2.0	06.01-05.04	96		LLE		0986 486 054	19,05	
2.4, quattro	04.97-05.04	100/115/120/121/125		LLE		0986 486 054	19,05	
2.5 TDI	04.97-04.01	110		LLE		0986 486 054	19,05	
2.5 TDI quattro	10.99-05.04	114/120/132		LLE		0986 486 061	19,05	
2.7 Biturbo quattro	06.01-05.04	184		LLE		0986 486 061	19,05	
2.7 Biturbo, Biturbo quattro	10.97-05.01	169		LLE		0986 486 054	19,05	
2.8, quattro	04.97-05.01	132/140/142		LLE		0986 486 054	19,05	
3.0, quattro	06.01-05.04	160/162		LLE		0986 486 061	19,05	











	1.8, T, T quattro	04.97-05.04	85/92/110/132				0986 486 548	22,2
	1.9 TDI	04.97-05.97	81	Fg.-Nr. →4B..W..019 484			0986 486 551	22,2
		04.97-10.00	81				0986 486 548	22,2
		05.99-04.01	85				0986 486 548	22,2
		06.01-05.04	96				0986 486 548	22,2
		2.0	06.01-05.04	96				0986 486 548

		S							
2.4, quattro		04.97-05.04	100/115/120/121/125					0 986 486 548	22,2
2.5 TDI, TDI quattro		04.97-05.04	110/114/120/132					0 986 486 548	22,2
2.7 Biturbo, Biturbo quattro		10.97-05.04	169/184					0 986 486 548	22,2
2.8, quattro		04.97-05.01	132/140/142					0 986 486 548	22,2
3.0, quattro		06.01-05.04	160/162					0 986 486 548	22,2
 1.8		05.97-04.01	85/92					0 265 202 403 ^M	
								CS2	0 265 220 407 ^E
1.8 T		04.97-01.99	110					CS2,EML	0 265 220 527 ^F
		04.97-05.04	110					CS2	0 265 220 407 ^E
		11.97-10.00	132					CS2	0 265 220 407 ^E
		11.98-01.00	110	Fg.-Nr. →4B..Y..091 500				CS2	0 265 220 527 ^F
1.8 T quattro		04.97-01.99	110					CS2,EML	0 265 220 527 ^F
		04.97-05.01	110					CS2	0 265 220 410 ^E
		06.97-10.00	132					CS2	0 265 220 410 ^E
		11.98-01.00	110	Fg.-Nr. →4B..Y..091 500				CS2	0 265 220 527 ^F
		06.01-05.04	110						0 265 225 122 ^T
1.8 T		04.97-05.04	110						0 265 202 403 ^M
1.8 T quattro		06.97-01.00	132	Fg.-Nr. →4B..Y..091 500				CS2	0 265 220 527 ^F
		06.97-10.00	132						0 265 202 403 ^M
1.9 TDI		04.97-10.00	81						0 265 202 403 ^M
								CS2	0 265 220 407 ^E
		05.99-01.00	85	Fg.-Nr. →4B..Y..091 500				CS2	0 265 220 527 ^F
		05.99-04.01	85						0 265 202 403 ^M
								CS2	0 265 220 407 ^E
		06.01-05.04	96						0 265 225 125 ^T
2.0		06.01-05.04	96					CS2	0 265 225 125 ^T
2.4		04.97-05.00	120					CS2	0 265 220 407 ^E
		04.97-04.01	121					CS2	0 265 220 407 ^E
		08.97-01.99	100					CS2,EML	0 265 220 527 ^F
		08.97-05.00	100						0 265 202 403 ^M
								CS2	0 265 220 407 ^E
		04.98-01.00	115	Fg.-Nr. →4B..Y..091 500				CS2,EML	0 265 220 527 ^F
		04.98-04.01	115					CS2	0 265 220 407 ^E
		06.01-05.04	100					CS2	0 265 225 125 ^T
			120					CS2	0 265 225 125 ^T
			125					CS2	0 265 225 125 ^T
2.4		04.97-01.99	120					CS2,EML	0 265 220 527 ^F
2.4 quattro		04.97-06.99	121					CS2,EML	0 265 220 527 ^F
		04.97-05.00	120						0 265 202 403 ^M
		04.97-09.01	121						0 265 202 403 ^M
		04.98-04.01	115						0 265 202 403 ^M
								CS2	0 265 220 413 ^F
		11.98-01.00	120	Fg.-Nr. →4B..Y..091 500				CS2,EML	0 265 220 527 ^F
			121	Fg.-Nr. →4B..Y..091 500				CS2,EML	0 265 220 527 ^F
		11.98-05.00	120					CS2	0 265 220 413 ^F
		11.98-09.01	121					CS2	0 265 220 413 ^F
2.4 quattro		04.97-09.01	121					CS2	0 265 220 410 ^E
		06.97-05.00	120					CS2	0 265 220 410 ^E
		08.98-07.99	115					CS2	0 265 220 410 ^E
								CS2,EML	0 265 220 527 ^F
		06.01-05.04	125						0 265 225 122 ^T
2.5 TDI		04.97-06.97	110	Fg.-Nr. →4B..W..006 000					0 265 220 440 ^E
		07.97-05.00	110	Fg.-Nr. 4B..W..006 001→				CS2	0 265 220 407 ^E
		07.98-01.00	110	Fg.-Nr. 4B..W..170 000→				CS2	0 265 220 527 ^F
				4B..Y..091 500, 4B..X..000 001→					
		11.98-04.01	110					CS2	0 265 220 407 ^E
									0 265 220 527 ^F
		10.99-01.00	132	Fg.-Nr. →4B..Y..091 500				CS2	0 265 220 527 ^F
		10.99-05.01	132						0 265 202 403 ^M
								CS2	0 265 220 407 ^E
		06.01-05.04	114/120					CS2	0 265 225 125 ^T
			132					CS2	0 265 225 125 ^T



		S							
◀ AUDI A6 [4B2; C5]									
2.5 TDI quattro	07.97-04.01	110				CS2	0 265 220 410 ^E		
	07.98-01.00	110	Fg.-Nr. 4B..W..170 000→ 4B..Y..091 500, 4B..X..000 001→			CS2	0 265 220 527 ^F		
	10.99-05.01	132				CS2	0 265 220 410 ^E		
	06.01-05.04	132					0 265 225 122 ^T		
2.5 TDI, TDI quattro	07.97-04.01	110					0 265 202 403 ^M		
2.7 Biturbo	02.99-01.00	169	Fg.-Nr. →4B..Y..091 500			CS2	0 265 220 527 ^F		
	02.99-05.01	169				CS2	0 265 220 407 ^E		
2.7 Biturbo quattro	10.97-05.01	169				CS2	0 265 220 410 ^E		
	06.01-05.04	184					0 265 225 122 ^T		
2.7 Biturbo, Biturbo quattro	10.97-05.01	169					0 265 202 403 ^M		
2.8	04.97-04.01	142				CS2	0 265 220 407 ^E		
	10.97-04.01	132/140				CS2	0 265 220 407 ^E		
2.8	04.97-01.99	142				CS2,EML	0 265 220 527 ^F		
2.8 quattro	04.97-05.01	142					0 265 202 403 ^M		
	10.97-01.00	132/140	Fg.-Nr. →4B..Y..091 500			CS2,EML	0 265 220 527 ^F		
	10.97-05.01	132/140					0 265 202 403 ^M		
						CS2	0 265 220 413 ^F		
	11.98-01.00	142	Fg.-Nr. →4B..Y..091 500			CS2,EML	0 265 220 527 ^F		
	11.98-04.00	142	Fg.-Nr. →4B..Y..200 000			CS2,EML	0 265 220 527 ^F		
	11.98-05.01	142				CS2	0 265 220 413 ^F		
2.8 quattro	04.97-05.01	142				CS2	0 265 220 410 ^E		
	04.98-05.01	132/140				CS2	0 265 220 410 ^E		
3.0	06.01-05.04	160/162				CS2	0 265 225 125 ^T		
3.0 quattro	06.01-08.04	160/162					0 265 225 122 ^T		
1.8	05.97-04.01	85/92					0 265 109 463 ^M		
1.8 T	04.97-05.04	110					0 265 109 463 ^M		
	11.97-10.00	132					0 265 109 463 ^M		
1.8 T quattro	04.97-05.99	110				FMP,GRG	0 265 109 426 ^M		
	06.97-06.99	132	Fg.-Nr. →8D..X..200 000			FMP,GRG	0 265 109 426 ^M		
	11.98-06.99	110	Fg.-Nr. →8D..X..200 000			FMP,GRG	0 265 109 426 ^M		
	07.99-10.00	132	Fg.-Nr. 8D..Y..000 001→			FMP,GRG	0 265 109 462 ^M		
	07.99-05.01	110	Fg.-Nr. 8D..Y..000 001→			FMP,GRG	0 265 109 462 ^M		
1.9 TDI	04.97-04.01	81/85					0 265 109 463 ^M		
2.4	04.97-05.00	120					0 265 109 463 ^M		
	04.97-04.01	121					0 265 109 463 ^M		
	08.97-05.00	100					0 265 109 463 ^M		
	04.98-04.01	115					0 265 109 463 ^M		
2.4 quattro	04.97-06.99	121				FMP,GRG	0 265 109 426 ^M		
	06.97-01.99	120				FMP,GRG	0 265 109 426 ^M		
	08.98-07.99	115				FMP,GRG	0 265 109 426 ^M		
	11.98-06.99	120	Fg.-Nr. →8D..X..200 000			FMP,GRG	0 265 109 426 ^M		
	07.99-05.00	120	Fg.-Nr. 8D..Y..000 001→			FMP,GRG	0 265 109 462 ^M		
	07.99-09.01	121	Fg.-Nr. 8D..Y..000 001→			FMP,GRG	0 265 109 462 ^M		
	06.00-05.01	121				FMP,GRG	0 265 109 462 ^M		
2.5 TDI	04.97-04.01	110					0 265 109 463 ^M		
	10.99-08.03	132					0 265 109 463 ^M		
2.5 TDI quattro	07.97-06.99	110	Fg.-Nr. →8D..X..200 000			FMP,GRG	0 265 109 426 ^M		
	11.98-04.01	110				FMP,GRG	0 265 109 426 ^M		
	07.99-05.00	110	Fg.-Nr. 8D..Y..000 001→			FMP,GRG	0 265 109 462 ^M		
	10.99-05.01	132				FMP,GRG	0 265 109 462 ^M		
2.7 Biturbo	02.99-05.01	169					0 265 109 463 ^M		
2.7 Biturbo quattro	10.97-06.99	169	Fg.-Nr. →8D..X..200 000			FMP,GRG	0 265 109 426 ^M		
	07.99-08.00	169	Fg.-Nr. 8D..Y..000 001→			FMP,GRG	0 265 109 462 ^M		
	09.00-05.01	169				FMP,GRG	0 265 109 462 ^M		
2.8	04.97-04.01	142					0 265 109 463 ^M		
	10.97-05.00	132					0 265 109 463 ^M		
	07.99-04.01	140					0 265 109 463 ^M		
2.8 quattro	04.97-01.99	142				FMP,GRG	0 265 109 426 ^M		
	04.98-06.99	132	Fg.-Nr. →8D..X..200 000			FMP,GRG	0 265 109 426 ^M		
	11.98-06.99	142	Fg.-Nr. →8D..X..200 000			FMP,GRG	0 265 109 426 ^M		











		S							
2.8 quattro		07.99-05.00	132	Fg.-Nr. 8D..Y..000 001→	FMP,GRG	0 265 109 462 ^M			
		07.99-05.01	142	Fg.-Nr. 8D..Y..000 001→	FMP,GRG	0 265 109 462 ^M			
		06.00-05.01	142		FMP,GRG	0 265 109 462 ^M			
 1.8		05.97-04.01	85/92			0 265 005 214			
1.8 T		04.97-05.04	110			0 265 005 214			
		11.97-10.00	132			0 265 005 214			
1.8 T quattro		04.97-10.98	110	Fg.-Nr. →4B..X..026 000		0 265 005 207			
		06.97-10.98	132	Fg.-Nr. →4B..X..026 000		0 265 005 207			
		10.98-01.99	110	Fg.-Nr. 4B..X..026 001→		0 265 005 214			
		10.98-10.00	132	Fg.-Nr. 4B..X..026 001→		0 265 005 214			
		11.98-05.01	110			0 265 005 214			
		06.01-05.04	110			0 265 005 252			
1.9 TDI		04.97-04.01	81/85			0 265 005 214			
		06.01-05.04	96			0 265 005 252			
2.0		06.01-05.04	96			0 265 005 252			
2.4		04.97-05.00	120			0 265 005 214			
		04.97-04.01	121			0 265 005 214			
		08.97-05.00	100			0 265 005 214			
		04.98-04.01	115			0 265 005 214			
		06.00-04.01	121			0 265 005 252			
		06.01-05.04	100			0 265 005 252			
			120			0 265 005 252			
2.4, quattro		06.01-05.04	125			0 265 005 252			
2.4 quattro		04.97-10.98	121	Fg.-Nr. →4B..X..026 000		0 265 005 207			
		06.97-10.98	120	Fg.-Nr. →4B..X..026 000		0 265 005 207			
		08.98-10.98	115	Fg.-Nr. →4B..X..026 000		0 265 005 207			
		10.98-01.99	120	Fg.-Nr. 4B..X..026 001→		0 265 005 214			
			121	Fg.-Nr. 4B..X..026 001→		0 265 005 214			
		10.98-07.99	115	Fg.-Nr. 4B..X..026 001→		0 265 005 214			
		11.98-05.00	120			0 265 005 214			
		11.98-09.01	121			0 265 005 214			
2.5 TDI		04.97-04.01	110			0 265 005 214			
		06.01-05.04	114/120			0 265 005 252			
2.5 TDI quattro		07.97-10.98	110	Fg.-Nr. →4B..X..026 000		0 265 005 207			
		10.98-05.00	110	Fg.-Nr. 4B..X..026 001→		0 265 005 214			
		11.98-04.01	110			0 265 005 214			
2.5 TDI		10.99-05.01	132			0 265 005 214			
2.5 TDI quattro		06.01-05.04	132			0 265 005 252			
2.7 Biturbo		02.99-05.01	169			0 265 005 214			
2.7 Biturbo quattro		10.97-10.98	169	Fg.-Nr. →4B..X..026 000		0 265 005 207			
		10.98-08.00	169	Fg.-Nr. 4B..X..026 001→		0 265 005 214			
		09.00-05.01	169			0 265 005 214			
		06.01-05.04	184			0 265 005 252			
2.8		04.97-04.01	142			0 265 005 214			
		10.97-05.00	132			0 265 005 214			
2.8, quattro		07.99-05.01	140			0 265 005 214			
2.8 quattro		04.97-10.98	142	Fg.-Nr. →4B..X..026 000		0 265 005 207			
		04.98-10.98	132	Fg.-Nr. →4B..X..026 000		0 265 005 207			
		10.98-01.99	142	Fg.-Nr. 4B..X..026 001→		0 265 005 214			
		10.98-05.00	132	Fg.-Nr. 4B..X..026 001→		0 265 005 214			
		11.98-05.01	142			0 265 005 214			
		06.00-05.01	142			0 265 005 252			
3.0, quattro		06.01-08.04	160/162			0 265 005 252			
 1.8, T, T quattro		11.98-05.04	92/110			0 265 005 303			
1.9 TDI		05.99-04.01	85			0 265 005 303			
		06.01-05.04	96			0 265 005 303			
2.0		06.01-05.04	96			0 265 005 303			
2.4, quattro		04.98-05.04	100/115/120/121/125			0 265 005 303			
2.5 TDI, TDI quattro		10.99-05.04	114/120/132			0 265 005 303			
2.7 Biturbo, Biturbo quattro		02.99-05.04	169/184			0 265 005 303			
2.8, quattro		11.98-05.01	140/142			0 265 005 303			













AUDI A6 [4B2; C5]								
	3.0, quattro	06.01-05.04	160/162				0 265 005 303	
A6 [4B4; C5]								
	4.2 quattro	06.01-07.04	220		JBH GIR	0 986 481 046	25,4	
		MFD 04.99-05.04	220		JBH,LLE	0 986 480 966	25,4	
					JBH,RLE	0 986 480 989	25,4	
		OFD 04.99-05.04	220		JBH,LLE	0 986 480 935	25,4	
	4.2 quattro	04.99-05.01	220		LLE	0 986 486 054	19,05	
		06.01-05.04	220		LLE	0 986 486 061	19,05	
	4.2 quattro	04.99-05.04	220			0 986 486 548	22,2	
	4.2 quattro	04.99-05.01	220			0 265 202 403 ^M		
					CS2	0 265 220 410 ^E		
		06.01-07.04	220			0 265 225 122 ^T		
	4.2 quattro	04.99-06.99	220	Fg.-Nr. →8D..X..200 000	FMP,GRG	0 265 109 426 ^M		
		07.99-05.01	220	Fg.-Nr. 8D..Y..000 001→	FMP,GRG	0 265 109 462 ^M		
	4.2 quattro	04.99-05.01	220			0 265 005 214		
		06.01-07.04	220			0 265 005 252		
	4.2 quattro	04.99-05.04	220			0 265 005 303		
A6 [4F2; C6]								
	2.8 FSI quattro	11.06-10.08	154			0 265 235 105 ^T		
	2.8 FSI quattro	11.06-10.08	154			0 265 005 619		
A6 [4F2; C6]								
	2.0 TDI, TDI e, TFSI	07.04-08.11	89/100/103/120/125		JBH	0 986 481 006	27	
	2.4, quattro	04.04-10.08	130		JBH	0 986 481 006	27	
	2.7 TDI, TDI quattro	11.04-08.11	120/132/140		JBH	0 986 481 006	27	
	2.8 FSI, FSI quattro	11.06-08.11	140/154/162		JBH	0 986 481 006	27	
	3.0, quattro, TDI quattro, TFSI quattro	04.04-09.11	155/160/165/171/176/213/220		JBH	0 986 481 006	27	
	3.2 FSI, FSI quattro	04.04-08.11	183/188/195		JBH	0 986 481 006	27	
	4.2 FSI quattro	06.06-08.11	257		FMS,JBH	0 986 481 046	25,4	
					FMS,JBH	0 986 481 006	27	
	4.2 quattro	04.04-05.06	246		JBH	0 986 481 006	27	
	2.0 TDI	07.04-01.05	100/103	Fg.-Nr. →4F..5..090 000, PR-Code 8T0, PR-Code 8T1		0 265 234 116 ^T		
		07.04-11.05	100/103	PR-Code 8T4		0 265 234 208 ^B		
		02.05-11.05	100/103	Fg.-Nr. 4F..5..090 001→, PR-Code 8T0, PR-Code 8T1		0 265 234 262 ^T		
		06.05-05.06	100/103	Fg.-Nr. →4F..6..250 000, PR-Code 8T0, PR-Code 8T1		0 265 234 262 ^T		
				Fg.-Nr. →4F..6..250 000, PR-Code 8T4		0 265 234 208 ^B		
		09.05-06.06	89	PR-Code 8T0, PR-Code 8T1		0 265 234 262 ^T		
				PR-Code 8T4		0 265 234 208 ^B		



	S								
2.0 TDI	06.06-06.08	100/103	Fg.-Nr. 4F..7..000 001→			0 265 235 102 ^T			
2.0 TFSI	06.05-05.06	125	Fg.-Nr. →4F..6..250 000	GES		0 265 234 208 ^B			
				GES		0 265 234 262 ^T			
	06.06-09.08	125	Fg.-Nr. 4F..7..000 001→			0 265 235 102 ^T			
	01.07-09.08	125				0 265 235 102 ^T			
2.4	04.04-01.05	130	Fg.-Nr. →4F..5..090 000, PR-Code 8T0, PR-Code 8T1			0 265 234 116 ^T			
	04.04-05.06	130	Fg.-Nr. →4F..6..250 000, PR-Code 8T4			0 265 234 208 ^B			
	02.05-05.06	130	Fg.-Nr. 4F..5..090 001→4F..6..250 000, PR-Code 8T0, PR-Code 8T1			0 265 234 262 ^T			
	06.06-10.08	130	Fg.-Nr. 4F..7..000 001→			0 265 235 102 ^T			
2.4 quattro	01.05-05.06	130	Fg.-Nr. →4F..6..250 000	GBM		0 265 234 211 ^T			
				GBM		0 265 234 265 ^T			
	06.06-10.08	130	Fg.-Nr. 4F..7..000 001→			0 265 235 105 ^T			
2.7 TDI	11.04-01.05	120/132	Fg.-Nr. →4F..5..090 000, PR-Code 8T0, PR-Code 8T1			0 265 234 116 ^T			
	11.04-05.06	120/132	Fg.-Nr. →4F..6..250 000, PR-Code 8T4			0 265 234 208 ^B			
	02.05-05.06	120/132	Fg.-Nr. 4F..5..090 001→4F..6..250 000, PR-Code 8T0, PR-Code 8T1			0 265 234 262 ^T			
	06.06-10.08	120/132	Fg.-Nr. 4F..7..000 001→			0 265 235 102 ^T			
2.7 TDI quattro	06.05-05.06	120/132	Fg.-Nr. →4F..6..250 000	GBM		0 265 234 211 ^T			
				GBM		0 265 234 265 ^T			
	06.06-10.08	120/132	Fg.-Nr. 4F..7..000 001→			0 265 235 105 ^T			
2.8 FSI	11.06-10.08	154				0 265 235 102 ^T			
						0 265 235 102 ^T			
3.0	04.04-01.05	160	Fg.-Nr. →4F..5..090 000, PR-Code 8T0, PR-Code 8T1			0 265 234 116 ^T			
	04.04-05.06	160	PR-Code 8T4			0 265 234 208 ^B			
	02.05-05.06	160	Fg.-Nr. 4F..5..090 001→, PR-Code 8T0, PR-Code 8T1			0 265 234 262 ^T			
3.0 quattro	04.04-01.05	160	Fg.-Nr. →4F..5..090 000	GBM		0 265 234 113 ^T			
	04.04-05.06	160		GBM		0 265 234 211 ^T			
	02.05-05.06	160	Fg.-Nr. 4F..5..090 001→	GBM		0 265 234 265 ^T			
3.0 TDI quattro	04.04-01.05	155	Fg.-Nr. →4F..5..090 000	GBM		0 265 234 113 ^T			
		165	Fg.-Nr. →4F..5..090 000	GBM		0 265 234 113 ^T			
	04.04-05.06	155	Fg.-Nr. →4F..6..250 000	GBM		0 265 234 211 ^T			
		165		GBM		0 265 234 211 ^T			
	02.05-05.06	155	Fg.-Nr. 4F..5..090 001→	GBM		0 265 234 265 ^T			
		165	Fg.-Nr. 4F..5..090 001→	GBM		0 265 234 265 ^T			
06.06-10.08	155	Fg.-Nr. 4F..7..000 001→			0 265 235 105 ^T				
	171				0 265 235 105 ^T				
3.2 FSI	04.04-01.05	188	Fg.-Nr. →4F..5..090 000	GBM		0 265 234 116 ^T			
	04.04-05.06	188	Fg.-Nr. →4F..6..250 000	GBM		0 265 234 208 ^T			
				GBM		0 265 234 262 ^T			
	06.06-09.08	188				0 265 235 102 ^T			
	06.06-10.08	188	Fg.-Nr. 4F..7..000 001→			0 265 235 102 ^T			
3.2 FSI quattro	04.04-01.05	188	Fg.-Nr. →4F..5..090 000	GBM		0 265 234 113 ^T			
	04.04-05.06	188	Fg.-Nr. →4F..6..250 000	GBM		0 265 234 211 ^T			
	02.05-05.06	188	Fg.-Nr. 4F..5..090 001→	GBM		0 265 234 265 ^T			
		188	4F..6..250 000						
	07.05-10.08	188				0 265 235 105 ^T			
	09.06-10.08	183				0 265 235 105 ^T			
4.2 FSI quattro	06.06-09.08	257	Fg.-Nr. 4F..7..000 001→			0 265 235 105 ^T			
4.2 quattro	04.04-01.05	246	Fg.-Nr. →4F..5..090 000	GBM		0 265 234 113 ^T			
	04.04-05.06	246		GBM		0 265 234 211 ^T			
	02.05-05.06	246	Fg.-Nr. 4F..5..090 001→	GBM		0 265 234 265 ^T			
 2.0 TDI	07.04-11.05	100				0 265 005 692			
		103				0 265 005 692			
	06.05-05.06	100	Fg.-Nr. →4F..6..250 000				0 265 005 692		
		103	Fg.-Nr. →4F..6..250 000				0 265 005 692		
	09.05-06.06	89				0 265 005 692			

















			S							
◀ AUDI A6 [4F2; C6]										
	2.0 TDI	06.06-06.08	100	Fg.-Nr. 4F..7..000 001→				0 265 005 619		
			103	Fg.-Nr. 4F..7..000 001→				0 265 005 619		
		04.09-08.11	120					0 265 005 777		
	2.0 TDI e	10.08-03.11	100					0 265 005 777		
	2.0 TDI, TFSI	10.08-08.11	125					0 265 005 777		
	2.0 TFSI	06.05-05.06	125	Fg.-Nr. →4F..6..250 000				0 265 005 692		
		06.06-09.08	125	Fg.-Nr. 4F..7..000 001→				0 265 005 619		
		01.07-09.08	125					0 265 005 619		
	2.4	04.04-05.06	130	Fg.-Nr. →4F..6..250 000				0 265 005 692		
	2.4 quattro	06.06-10.08	130	Fg.-Nr. 4F..7..000 001→				0 265 005 619		
	2.7 TDI	11.04-05.06	120	Fg.-Nr. →4F..6..250 000				0 265 005 692		
	2.7 TDI quattro		132	Fg.-Nr. →4F..6..250 000				0 265 005 692		
		06.06-10.08	120	Fg.-Nr. 4F..7..000 001→				0 265 005 619		
			132	Fg.-Nr. 4F..7..000 001→				0 265 005 619		
		10.08-08.11	120					0 265 005 777		
			140					0 265 005 777		
	2.8 FSI	11.06-10.08	154					0 265 005 619		
	2.8 FSI	10.08-08.11	140					0 265 005 777		
	2.8 FSI quattro		162					0 265 005 777		
	3.0, quattro, TDI quattro	04.04-05.06	160/165					0 265 005 692		
	3.0 TDI quattro	04.04-05.06	155	Fg.-Nr. →4F..6..250 000				0 265 005 692		
		06.06-10.08	155	Fg.-Nr. 4F..7..000 001→				0 265 005 619		
			171					0 265 005 619		
		10.08-08.11	155					0 265 005 777		
	3.0 TDI quattro, TFSI quattro	10.08-09.11	176/213/220					0 265 005 777		
	3.2 FSI	06.06-09.08	188					0 265 005 619		
		06.06-10.08	188	Fg.-Nr. 4F..7..000 001→				0 265 005 619		
		10.08-05.09	188					0 265 005 777		
		03.09-08.11	195					0 265 005 777		
	3.2 FSI quattro	06.06-10.08	188	Fg.-Nr. 4F..7..000 001→				0 265 005 619		
		09.06-10.08	183					0 265 005 619		
	3.2 FSI, FSI quattro	04.04-05.06	188	Fg.-Nr. →4F..6..250 000				0 265 005 692		
	4.2 FSI quattro	06.06-05.08	257	Fg.-Nr. →4F..8..152 360				0 265 005 619		
		06.08-08.11	257	Fg.-Nr. 4F..8..152 361→				0 265 005 777		
	4.2 quattro	04.04-05.06	246					0 265 005 692		
A8 [4D2; D2]										
	2.5 TDI	MFD 06.97-09.02	110/132					0 986 480 966	25,4	
	2.5 TDI quattro	OFD 06.97-09.02	110/132					0 986 480 935	25,4	
	2.8	MFD 06.94-09.02	120/128/142					0 986 480 966	25,4	
	2.8 quattro	OFD 06.94-09.02	120/128/142					0 986 480 935	25,4	
	3.3 TDI quattro	MFD 12.99-08.02	165					0 986 480 966	25,4	
		OFD 12.99-08.02	165					0 986 480 935	25,4	
	3.7	MFD 07.95-12.98	169					0 986 480 966	25,4	
	3.7 quattro	10.98-09.02	191					0 986 480 966	25,4	
		OFD 07.95-12.98	169					0 986 480 935	25,4	
		10.98-09.02	191					0 986 480 935	25,4	
	4.2 quattro	MFD 06.94-09.02	175/180/210/220-224/228					0 986 480 966	25,4	
		OFD 06.94-09.02	175/180/210/220-224/228					0 986 480 935	25,4	
	6.0 quattro	MFD 03.01-08.02	309					0 986 480 966	25,4	
		OFD 03.01-08.02	309					0 986 480 935	25,4	
	2.5 TDI, TDI quattro	06.97-09.02	110/132					0 986 486 548	22,2	
	2.8	03.96-04.99	142						0 986 486 532	22,2
01.99-04.00		142	Fg.-Nr. →4D..Y..020 000					0 986 486 532	22,2	
05.00-09.02		142						0 986 486 548	22,2	
2.8, quattro		06.94-03.96	120/128					0 986 486 532	22,2	
2.8 quattro	03.96-04.99	142						0 986 486 532	22,2	
	05.00-09.02	142						0 986 486 548	22,2	
3.7	07.95-12.98	169					0 986 486 532	22,2		
3.7 quattro	10.98-09.02	191					0 986 486 532	22,2		

									
4.2 quattro		06.94-12.98	180/210/220-224				0 986 486 532	22,2	
 2.5 TDI		06.97-09.02	110				0 265 202 403 ^M		
		07.98-09.02	110	Fg.-Nr. 4D..W..020 001→	CS2		0 265 220 527 ^F		
		05.00-09.02	132				0 265 202 403 ^M		
2.5 TDI quattro		06.97-06.00	110				0 265 202 403 ^M		
		11.99-09.02	132				0 265 202 403 ^M		
					CS2		0 265 220 410 ^E		
2.8		03.96-04.99	142				0 265 220 410 ^E		
		03.96-09.02	142				0 265 220 413 ^F		
		01.99-09.02	142				0 265 202 403 ^M		
2.8 quattro		09.94-03.96	120/128				0 265 220 527 ^F		
		03.96-04.99	142				0 265 220 413 ^F		
		07.96-04.97	142	Fg.-Nr. 4D..V..000 001→4D..V..011 800			0 265 220 443 ^E		
3.3 TDI quattro		04.97-12.98	142	Fg.-Nr. 4D..V..011 801→	CS2		0 265 220 410 ^E		
		10.97-04.99	142				0 265 220 410 ^E		
		05.00-09.02	142				0 265 202 403 ^M		
					CS2		0 265 220 410 ^E		
							0 265 220 403 ^M		
3.7		12.99-08.02	165				0 265 202 403 ^M		
					CS2		0 265 220 410 ^E		
		07.95-12.98	169				0 265 202 403 ^M		
3.7 quattro		10.98-09.02	191				0 265 220 413 ^F		
					CS2		0 265 202 403 ^M		
		10.95-12.98	169				0 265 220 527 ^F		
4.2 quattro		07.96-04.97	169	Fg.-Nr. 4D..V..000 001→4D..V..011 800			0 265 202 403 ^M		
		04.97-12.98	169	Fg.-Nr. 4D..V..011 801→	CS2		0 265 220 443 ^E		
		05.97-12.98	169				0 265 220 410 ^E		
		10.98-09.02	191				0 265 202 403 ^M		
							0 265 220 410 ^E		
						CS2	0 265 220 410 ^E		
							0 265 220 410 ^E		
4.2 quattro		06.94-07.96	180				0 265 220 443 ^E		
		06.94-12.98	210				0 265 202 403 ^M		
			220-224				0 265 202 403 ^M		
		07.96-04.97	210	Fg.-Nr. 4D..V..000 001→4D..V..011 800			0 265 220 443 ^E		
			220-224	Fg.-Nr. 4D..V..000 001→4D..V..011 800			0 265 220 443 ^E		
		04.97-12.98	210	Fg.-Nr. 4D..V..011 801→	CS2		0 265 220 410 ^E		
			220				0 265 202 403 ^M		
						CS2	0 265 220 410 ^E		
			220-224	Fg.-Nr. 4D..V..011 801→	CS2		0 265 220 410 ^E		
		10.98-09.02	228				0 265 202 403 ^M		
6.0 quattro							0 265 220 410 ^E		
		02.99-04.00	175				0 265 202 403 ^M		
					CS2		0 265 220 410 ^E		
 2.5 TDI		03.01-08.02	309				0 265 202 403 ^M		
		06.97-04.99	110	Fg.-Nr. →4D..X..015 000	CFG		0 265 109 444 ^M		
		05.99-09.02	110	Fg.-Nr. 4D..Y..000 001→			0 265 109 461 ^M		
2.5 TDI quattro		05.00-09.02	132				0 265 109 461 ^M		
		06.97-10.98	110	Fg.-Nr. →4D..X..004 999	GRG		0 265 109 400 ^M		
		10.98-04.99	110	Fg.-Nr. 4D..X..005 001→	CFG		0 265 109 443 ^M		
2.8				Fg.-Nr. 4D..X..005 001→	CFG		0 265 109 443 ^M		
				4D..X..015 000			0 265 109 460 ^M		
		05.99-06.00	110	Fg.-Nr. 4D..Y..000 001→	CFG		0 265 109 460 ^M		
		11.99-09.02	132		CFG		0 265 109 460 ^M		
		06.94-03.96	128				0 265 109 002 ^K		
2.8		07.95-03.96	120				0 265 109 002 ^K		
		03.96-07.96	142	Fg.-Nr. →4D..T..015 000			0 265 109 002 ^K		
		03.96-10.98	142	Fg.-Nr. →4D..X..004 999	GRG		0 265 109 400 ^M		
		10.98-12.98	142	Fg.-Nr. 4D..X..005 001→	CFG		0 265 109 443 ^M		
		01.99-04.99	142		CFG		0 265 109 444 ^M		





AUDI A8 [4D2; D2]							
2.8	05.99-02.01	142	Fg.-Nr. 4D..Y..000 001→		0 265 109 461 ^M		
	05.00-09.02	142			0 265 109 461 ^M		
2.8 quattro	09.94-07.95	128	Fg.-Nr. →4A..S..012 000	AG	0 265 109 024 ^H		
			Fg.-Nr. →8D..S..012 000	GS	0 265 109 026 ^K		
	07.95-03.96	128	Fg.-Nr. 8D..T..000 001→		0 265 109 031 ^J		
	03.96-10.98	142	Fg.-Nr. →4D..X..004 999		0 265 109 400 ^M		
	10.98-12.98	142	Fg.-Nr. 4D..X..005 001→		0 265 109 443 ^M		
	01.99-04.99	142			0 265 109 443 ^M		
	05.00-09.02	142			0 265 109 460 ^M		
3.3 TDI quattro	12.99-08.02	165			0 265 109 460 ^M		
3.7	07.95-07.96	169	Fg.-Nr. →4D..T..015 000		0 265 109 002 ^K		
	07.95-10.98	169	Fg.-Nr. →4D..X..004 999		0 265 109 400 ^M		
	05.99-02.01	191	Fg.-Nr. 4D..Y..000 001→		0 265 109 460 ^M		
	05.00-09.02	191			0 265 109 461 ^M		
3.7	10.98-12.98	169	Fg.-Nr. 4D..X..005 001→		0 265 109 443 ^M		
3.7 quattro	10.98-04.99	191	Fg.-Nr. →4D..X..015 000		0 265 109 443 ^M		
3.7 quattro	10.95-10.98	169	Fg.-Nr. →4D..X..004 999		0 265 109 400 ^M		
			Fg.-Nr. 4D..Y..000 001→		0 265 109 460 ^M		
	05.00-09.02	191			0 265 109 460 ^M		
					0 265 109 460 ^M		
4.2 quattro	06.94-07.95	180	Fg.-Nr. →4A..S..012 000	AG	0 265 109 024 ^H		
			Fg.-Nr. →8D..S..012 000	GS	0 265 109 026 ^K		
		210	Fg.-Nr. →4A..S..012 000		AG	0 265 109 024 ^H	
			Fg.-Nr. →8D..S..012 000		GS	0 265 109 026 ^K	
		220-224	Fg.-Nr. →4A..S..012 000		AG	0 265 109 024 ^H	
			Fg.-Nr. →8D..S..012 000		GS	0 265 109 026 ^K	
	06.94-10.98	210	Fg.-Nr. →4D..X..004 999		GRG	0 265 109 400 ^M	
			Fg.-Nr. →4D..X..004 999		GRG	0 265 109 400 ^M	
	07.95-07.96	180	Fg.-Nr. 8D..T..000 001→		GS	0 265 109 031 ^J	
			Fg.-Nr. 8D..T..000 001→		GS	0 265 109 031 ^J	
		210	Fg.-Nr. 8D..T..000 001→		GS	0 265 109 031 ^J	
	04.97-10.98	220	Fg.-Nr. →4D..X..004 999		GRG	0 265 109 400 ^M	
			Fg.-Nr. 4D..X..005 001→		CFG	0 265 109 443 ^M	
		210	Fg.-Nr. 4D..X..005 001→		CFG	0 265 109 443 ^M	
			Fg.-Nr. 4D..X..005 001→		CFG	0 265 109 443 ^M	
		220-224	Fg.-Nr. 4D..X..005 001→		CFG	0 265 109 443 ^M	
			Fg.-Nr. →4D..X..015 000		CFG	0 265 109 443 ^M	
		02.99-04.99	175	Fg.-Nr. →4D..X..015 000		CFG	0 265 109 443 ^M
		05.99-04.00	175	Fg.-Nr. 4D..Y..000 001→		CFG	0 265 109 460 ^M
		05.99-02.01	228	Fg.-Nr. 4D..Y..000 001→		CFG	0 265 109 460 ^M
		05.00-09.02	228			CFG	0 265 109 460 ^M
	6.0 quattro	03.01-08.02	309			CFG	0 265 109 474 ^M
	2.5 TDI, TDI quattro	06.97-09.02	110/132		0 265 005 162 ^S		
	2.8, quattro	03.96-09.02	142		0 265 005 162 ^S		
	3.3 TDI quattro	12.99-08.02	165		0 265 005 162 ^S		
	3.7	07.95-12.98	169		0 265 005 162 ^S		
	3.7 quattro	10.98-09.02	191		0 265 005 162 ^S		
	4.2 quattro	06.94-09.02	175/210/220-224/228		0 265 005 162 ^S		
	6.0 quattro	03.01-08.02	309		0 265 005 162 ^S		
	2.5 TDI, TDI quattro	06.97-09.02	110/132		0 265 005 207		
	2.8, quattro	03.96-09.02	142		0 265 005 207		
	3.3 TDI quattro	12.99-08.02	165		0 265 005 207		
	3.7	07.95-12.98	169		0 265 005 207		
	3.7 quattro	10.98-09.02	191		0 265 005 207		
	4.2 quattro	06.94-09.02	175/210/220-224/228		0 265 005 207		
	6.0 quattro	03.01-08.02	309		0 265 005 207		
	2.5 TDI, TDI quattro	11.97-09.02	110/132		0 265 005 303		
	2.8, quattro	01.99-09.02	142		0 265 005 303		
	3.3 TDI quattro	12.99-08.02	165		0 265 005 303		

		S							
3.7, quattro		10.98-09.02	191				0 265 005 303		
4.2 quattro		10.98-09.02	228				0 265 005 303		
6.0 quattro		03.01-08.02	309				0 265 005 303		
A8 [4E; D3]									
									
	3.0	07.03-05.05	162			CS2	0 265 225 137 ^T		
		07.03-05.06	160			CS2	0 265 225 137 ^T		
	3.0 quattro	11.03-05.06	160			CS2	0 265 225 296 ^T		
	3.0 TDI quattro	11.03-08.07	155			CS2	0 265 225 296 ^T		
		01.04-08.07	171			CS2	0 265 225 296 ^T		
		09.07-05.08	155	Fg.-Nr. →4E..8..030 000			0 265 225 409 ^T		
			171	Fg.-Nr. →4E..8..030 000			0 265 225 409 ^T		
	3.2 FSI	06.05-08.07	191			CS2	0 265 225 137 ^T		
	3.2 FSI quattro	06.05-08.07	191			CS2	0 265 225 296 ^T		
		09.07-05.08	191	Fg.-Nr. →4E..8..030 000			0 265 225 409 ^T		
	3.7 quattro	11.02-05.06	206			CS2	0 265 225 296 ^T		
	4.0 TDI quattro	05.03-10.03	202	Fg.-Nr. →4E..4..013 000		CS2	0 265 225 134 ^T		
		11.03-07.05	202	Fg.-Nr. 4E..4..013 001→		CS2	0 265 225 296 ^T		
	4.2 FSI quattro	06.06-08.07	257			CS2	0 265 225 296 ^T		
		09.07-05.08	257	Fg.-Nr. →4E..8..030 000			0 265 225 409 ^T		
	4.2 quattro	11.02-10.03	246	Fg.-Nr. →4E..4..013 000		CS2	0 265 225 134 ^T		
		11.03-05.06	246	Fg.-Nr. 4E..4..013 001→		CS2	0 265 225 296 ^T		
	4.2 TDI quattro	01.05-06.05	235			CS2	0 265 225 296 ^T		
		07.05-08.07	240			CS2	0 265 225 296 ^T		
		09.07-05.08	240	Fg.-Nr. →4E..8..030 000			0 265 225 409 ^T		
	6.0 quattro	02.04-08.05	331	Fg.-Nr. →4E..6..009 400		FKR,FMS	0 265 225 329 ^T		
						FLR,FMS	0 265 225 318 ^T		
		02.04-05.08	331	Fg.-Nr. →4E..8..030 000		FMS	0 265 225 353 ^T		
		09.05-08.07	331	Fg.-Nr. 4E..6..009 401→		FMS	0 265 225 350 ^T		
		09.07-05.08	331	Fg.-Nr. →4E..8..030 000		FMS	0 265 225 374 ^T		
	2.8 FSI	09.07-07.10	154/170				0 265 005 252		
	3.0, quattro, TDI quattro	07.03-07.10	155/160/162/171				0 265 005 252		
	3.2 FSI, FSI quattro	06.05-07.10	191				0 265 005 252		
	3.7 quattro	11.02-05.06	206				0 265 005 252		
	4.0 TDI quattro	05.03-07.05	202				0 265 005 252		
	4.2 FSI quattro, quattro, TDI quattro	11.02-07.10	235/240/246/257				0 265 005 252		
	6.0 quattro	02.04-07.10	331				0 265 005 252		
	2.8 FSI	09.07-07.10	154/170				0 265 005 303		
	3.0, quattro, TDI quattro	07.03-07.10	155/160/162/171				0 265 005 303		
	3.2 FSI, FSI quattro	06.05-07.10	191				0 265 005 303		
	3.7 quattro	11.02-05.06	206				0 265 005 303		
	4.0 TDI quattro	05.03-07.05	202				0 265 005 303		
	4.2 FSI quattro, quattro, TDI quattro	11.02-07.10	235/240/246/257				0 265 005 303		
	6.0 quattro	02.04-07.10	331				0 265 005 303		
Cabriolet [8G7; B4]									
									
	1.9 TDI	07.95-08.00	66			JBH,RLE	0 986 480 838	22,2	
		ABO 07.95-08.00	66			JBH,LLE	0 986 480 911	23	
		ABS 07.95-08.00	66			JBH,LLE	0 986 480 832	23,8	
	2.0	01.93-09.98	85/103			JBH,RLE	0 986 480 838	22,2	
		ABO 01.93-09.98	85/103			JBH,LLE	0 986 480 911	23	
		ABS 01.93-09.98	85/103			JBH,LLE	0 986 480 832	23,8	
	2.3	ABO 08.92-07.94	98	Fg.-Nr. 8G..P..000 001→		JBH,LLE	0 986 480 911	23	
		ABS 06.91-07.94	98			JBH,LLE,RLE	0 986 480 838	22,2	
		08.92-07.94	98	Fg.-Nr. 8G..P..000 001→		JBH,LLE	0 986 480 832	23,8	



		S							
	◀ AUDI Cabriolet [8G7; B4]								
	2.6	01.94-08.00	110			JBH,LLE	0986 480 832	23,8	
		05.95-12.99	102			JBH	0986 480 832	23,8	
	2.8	11.92-08.00	128			JBH,LLE	0986 480 832	23,8	
	1.8	01.97-08.00	92				0986 486 015	19,05	
	1.9 TDI	07.95-08.00	66				0986 486 015	19,05	
	2.0	01.93-09.98	85/103				0986 486 015	19,05	
	2.3	06.91-07.94	98				0986 486 015	19,05	
	2.6	01.94-08.00	102/110				0986 486 015	19,05	
	2.8	11.92-08.00	128				0986 486 015	19,05	
	1.8	01.97-08.00	92				0986 486 532	22,2	
	1.9 TDI	07.95-08.00	66				0986 486 532	22,2	
	2.0	01.93-09.98	85/103				0986 486 532	22,2	
	2.3	06.91-07.94	98				0986 486 532	22,2	
	2.6	01.94-08.00	102/110				0986 486 532	22,2	
	2.8	11.92-08.00	128				0986 486 532	22,2	
	1.8	01.97-08.00	92				0986 482 008 ^A		
	1.9 TDI	07.95-08.00	66				0986 482 008 ^A		
	2.0	01.93-09.98	85/103				0986 482 008 ^A		
	2.3	06.91-07.94	98				0986 482 008 ^A		
	2.6	01.94-08.00	102/110				0986 482 008 ^A		
	1.8	01.97-08.00	92				0 265 201 050 ^H		
							0 265 211 006 ^K		
	1.9 TDI	07.95-08.00	66				0 265 201 050 ^H		
							0 265 211 006 ^K		
	2.0	01.93-09.98	85/103				0 265 201 050 ^H		
							0 265 211 006 ^K		
	2.3	06.91-07.94	98				0 265 201 050 ^H		
							0 265 211 006 ^K		
	2.6	01.94-08.00	102/110				0 265 201 050 ^H		
							0 265 211 006 ^K		
	2.8	11.92-08.00	128				0 265 201 050 ^H		
							0 265 211 006 ^K		
	1.8	01.97-08.00	92			KZA	0 265 100 057 ^H		
						KZG	0 265 104 006 ^K		
	1.9 TDI	07.95-08.00	66			KZA	0 265 100 057 ^H		
						KZG	0 265 104 006 ^K		
	2.0	01.93-09.98	85/103			KZA	0 265 100 057 ^H		
						KZG	0 265 104 006 ^K		
	2.3	08.92-07.94	98		Fg.-Nr. 8G..P..000 001→	KZA	0 265 100 057 ^H		
						KZG	0 265 104 006 ^K		
	2.6	01.94-08.00	102/110			KZA	0 265 100 057 ^H		
						KZG	0 265 104 006 ^K		
	2.8	11.92-08.00	128			KZA	0 265 100 057 ^H		
						KZG	0 265 104 006 ^K		
Coupé S2 [89; B3]									
	2.2 T quattro	10.92-12.95	169			JBH	0986 480 943	25,4	
	2.2 T quattro	10.92-12.95	169				0986 486 532	22,2	
	2.2 T quattro	10.92-12.95	169				0 265 205 007 ^H		



		S								
	2.2 T quattro	10.92-12.95	169						0 265 103 051 ^H	
Coupé [89; B3]										
	2.0	ABO 08.92-12.95	85	Fg.-Nr. 8B..P..000 001→	JBH				0 986 480 911	23
			103		JBH,LLE				0 986 480 911	23
		ABS 08.92-12.95	85	Fg.-Nr. 8G..P..000 001→	JBH				0 986 480 832	23,8
			103		JBH,LLE				0 986 480 832	23,8
	2.3	ABO 08.92-07.94	98	Fg.-Nr. 8B..P..000 001→	JBH				0 986 480 911	23
		ABS 08.92-07.94	98	Fg.-Nr. 8G..P..000 001→	JBH				0 986 480 832	23,8
	2.3 quattro	ABO 11.88-07.94	98		JBH				0 986 480 836	22,2
		ABS 11.88-07.94	98		JBH				0 986 480 838	22,2
	2.6	08.92-12.95	110		JBH,LLE				0 986 480 832	23,8
	2.6 quattro	08.92-12.95	110		LLE				0 986 480 829	23,8
	2.8	ABO 09.91-12.95	128		JBH,LLE				0 986 480 911	23
		ABS 09.91-12.95	128		JBH,LLE				0 986 480 832	23,8
	2.8 quattro	08.91-12.95	128		LLE				0 986 480 829	23,8
	2.0	09.91-12.95	85/103						0 986 486 015	19,05
	2.3, quattro	11.88-07.94	98						0 986 486 015	19,05
	2.6, quattro	08.92-12.95	110						0 986 486 015	19,05
	2.8, quattro	08.91-12.95	128						0 986 486 015	19,05
	2.0	09.91-12.95	85/103						0 986 486 532	22,2
	2.3, quattro	11.88-07.94	98						0 986 486 532	22,2
	2.6, quattro	08.92-12.95	110						0 986 486 532	22,2
	2.8, quattro	08.91-12.95	128						0 986 486 532	22,2
	2.0	09.91-12.95	85/103						0 986 482 008 ^A	
	2.3	11.88-07.94	98						0 986 482 008 ^A	
	2.6	08.92-12.95	110						0 986 482 008 ^A	
	2.0	09.91-12.95	85/103						0 265 201 050 ^H	
									0 265 211 006 ^K	
	2.3	07.91-07.94	98	Fg.-Nr. 8B..N..000 001→					0 265 201 050 ^H	
	2.3 quattro	11.88-07.94	98						0 265 205 007 ^H	
	2.6	08.92-12.95	110						0 265 201 050 ^H	
									0 265 211 006 ^K	
	2.6 quattro	08.92-12.95	110						0 265 205 007 ^H	
	2.8	09.91-12.95	128						0 265 201 050 ^H	
									0 265 211 006 ^K	
	2.8 quattro	08.91-12.95	128						0 265 205 007 ^H	
	2.0	08.92-12.95	85	Fg.-Nr. 8B..P..000 001→	KZA				0 265 100 057 ^H	
					KZG				0 265 104 006 ^K	
			103		KZA				0 265 100 057 ^H	
					KZG				0 265 104 006 ^K	
	2.3	08.92-07.94	98	Fg.-Nr. 8B..P..000 001→	KZA				0 265 100 057 ^H	
					KZG				0 265 104 006 ^K	
	2.3 quattro	08.92-07.94	98	Fg.-Nr. 8B..P..000 001→					0 265 103 051 ^H	
	2.6	08.92-12.95	110		KZA				0 265 100 057 ^H	
					KZG				0 265 104 006 ^K	
	2.6 quattro	08.92-12.95	110						0 265 103 051 ^H	
	2.8	08.92-12.95	128	Fg.-Nr. 8B..P..000 001→	KZA				0 265 100 057 ^H	
					KZG				0 265 104 006 ^K	
	2.8 quattro	08.91-12.95	128						0 265 103 051 ^H	





◀ AUDI

Q3 [8U]



	1.4 TFSI	10.13→	110		0 986 486 595	29
	2.0 TFSI quattro	06.11→	125		0 986 486 595	29

Q5 [8RB]





























	2.0 TDI quattro	11.08-09.12	120/125	FDS	0 265 005 739	
		11.08→	120/125	FDS	0 265 005 741	
		06.12→	130	FDS	0 265 005 741	
		04.14→	140	FDS	0 265 005 741	
	2.0 TDI	08.09→	100/105	FDS	0 265 005 741	
	2.0 TDI quattro			FDS	0 265 005 739	
		05.13→	110	FDS	0 265 005 741	
	2.0 TFSI Hybrid quattro	06.11→	155-180	FDS	0 265 005 741	
	2.0 TFSI quattro					
	2.0 TFSI quattro flexible fuel					
	2.0 TFSI quattro	11.08-09.12	155	FDS	0 265 005 741	
				FDS	0 265 005 739	
		08.09-09.12	132	FDS	0 265 005 741	
				FDS	0 265 005 739	
	3.0 TDI quattro	11.08-09.12	155	FDS	0 265 005 741	
				FDS	0 265 005 739	
			176	FDS	0 265 005 741	
				FDS	0 265 005 739	
		09.13→	176	FDS	0 265 005 741	
	3.0 TDI quattro, TFSI quattro	06.12→	180/184/190/200	FDS	0 265 005 741	
	3.2 FSI quattro	11.08-09.12	199	FDS	0 265 005 741	
				FDS	0 265 005 739	

RS4 Avant [8D5; B5]



	2.7 quattro	05.00-09.01	280	JBH,LLE	0 986 480 966	25,4
				JBH,RLE	0 986 480 989	25,4
	2.7 quattro	05.00-09.01	280	LLE	0 986 486 054	19,05
	2.7 quattro	05.00-09.01	280		0 986 486 548	22,2
	2.7 quattro	05.00-09.01	280		0 265 202 403^M	
	2.7 quattro	05.00-09.01	280	GRG	0 265 109 462^M	
	2.7 quattro	05.00-09.01	280		0 265 005 162^S	
	2.7 quattro	05.00-09.01	280		0 265 005 207	
					0 265 005 214	



		S							
RS4 Avant [8ED; B7]									
									
	4.2 quattro	05.06-06.08	309			JBH	0 986 481 006	27	
	4.2 quattro	05.06-06.08	309			LLE	0 986 486 062	19,05	
	4.2 quattro	05.06-06.08	309				0 986 486 583	22,2	
	4.2 quattro	05.06-06.08	309				0 265 234 229 ^T		
	4.2 quattro	05.06-06.08	309				0 265 005 621		
RS4 Avant [8K5; B8]									
									
	4.2 quattro	05.12→	331			FDS	0 265 005 741		
RS4 Cabriolet [8HE; B7]									
									
	4.2 quattro	05.06-01.08	309			JBH	0 986 481 006	27	
	4.2 quattro	05.06-01.08	309			LLE	0 986 486 062	19,05	
	4.2 quattro	05.06-01.08	309				0 986 486 583	22,2	
	4.2 quattro	05.06-01.08	309				0 265 234 229 ^T		
	4.2 quattro	05.06-01.08	309				0 265 005 621		
RS4 [8EC; B7]									
									
	4.2 quattro	11.05-06.08	309			JBH	0 986 481 006	27	
	4.2 quattro	11.05-06.08	309			LLE	0 986 486 062	19,05	
	4.2 quattro	11.05-06.08	309				0 986 486 583	22,2	
	4.2 quattro	11.05-06.08	309				0 265 234 229 ^T		



◀ AUDI RS4 [8EC; B7]								
	4.2 quattro	11.05-06.08	309			0 265 005 621		
RS5 Cabriolet [8F7]								
	4.2 FSI quattro	11.12→	331		FDS	0 265 005 741		
RS5 Coupé [8T3]								
	4.2 FSI quattro	03.10→	331		PR-Code 1N1, PR-Code 1N7, PR-Code 1N3 PR-Code 1N7, PR-Code 1N1, PR-Code 1N3	0 265 005 739 0 265 005 741		
RS6 Avant [4B6]								
	4.2 quattro	05.02-09.04	331/353		JBH	0 986 481 006	27	
	4.2 quattro	05.02-09.04	331/353			0 265 225 169 ^T		
	4.2 quattro	05.02-09.04	331/353			0 265 005 252		
	4.2 quattro	05.02-09.04	331/353			0 265 005 303		
RS6 Avant [4F5; C6]								
	5.0 TFSI quattro	04.08-08.10	426		JBH	0 986 481 006	27	
	5.0 TFSI quattro	04.08-05.08	426		Fg.-Nr. →4F..8..901 276	0 265 005 619		
		06.08-08.10	426		Fg.-Nr. 4F..8..901 277→	0 265 005 777		
RS6 [4B4]								
	4.2 quattro	07.02-04.04	331		JBH	0 986 481 006	27	
	4.2 quattro	07.02-04.04	331			0 265 225 169 ^T		
	4.2 quattro	07.02-04.04	331			0 265 005 252		
	4.2 quattro	07.02-04.04	331			0 265 005 303		
RS6 [4F2; C6]								
	5.0 TFSI quattro	09.08-08.10	426		JBH	0 986 481 006	27	





























		S								
	5.0 TFSI quattro	09.08-08.10	426						0 265 005 777	
R8 Spyder GT [427]										
	5.2 FSI quattro	11.11-10.12	412				MBH		0 265 005 777	
R8 Spyder [429]										
	4.2 FSI quattro	09.10→	316				MBH		0 265 005 777	
	5.2 FSI quattro	02.10-07.12	386				MBH		0 265 005 777	
R8 [422]										
	5.2 FSI GT quattro	11.10-10.12	412				MBH		0 265 005 777	
R8 [423]										
	4.2 FSI quattro	04.07-07.08	309	Fg.-Nr. →42..9..000 460			MBH		0 265 005 621	
		08.08-09.10	309	Fg.-Nr. 42..9..000 461→			MBH		0 265 005 619	
		09.10→	316				MBH		0 265 005 777	
	5.2 FSI quattro	04.09-07.12	386				MBH		0 265 005 777	
SQ5 [8RB]										
	3.0 TDI quattro	12.12→	230				FDS		0 265 005 741	
		05.15→	230				EAL		0 265 005 741	
			240				EAL		0 265 005 741	
	3.0 TFSI quattro	06.13→	260				FDS		0 265 005 741	
S3 Cabriolet [8V7]										
	2.0 TFSI quattro	05.14→	210/221	PR-Code OEC			MQ0		0 986 486 554	19,05
S3 Limousine [8VS]										
	2.0 TFSI quattro	11.13→	221	PR-Code OEC			MQ0		0 986 486 554	19,05
S3 Sportback [8PA]										
	2.0 TFSI quattro	07.08-03.13	188/195						0 986 486 595	29



		S							
◀ AUDI									
S3 Sportback [8VA]									
	2.0 TFSI quattro	05.13→	206/221	PR-Code OEC	MQO	0986	486 554	19,05	
S3 [8L1]									
	1.8 quattro	08.98-04.03	154/165		JBH,LLE	0986	481 022	23,81	
	1.8 quattro	08.98-04.02	154		LLE	0986	486 031	15,87	
					RLE	0986	486 047	15,87	
	1.8 quattro	08.98-04.02	154		FSG	0986	486 542	23,81	
					FSZ	0986	486 538	19	
S3 [8P1]									
	2.0 TFSI quattro	11.06-06.08	188/195	PR-Code OEM	MQO	0986	486 554	19,05	
		07.08-03.13	188/195				486 595	29	
S3 [8V1]									
	2.0 TFSI quattro	11.12→	206/221	PR-Code OEC	MQO	0986	486 554	19,05	
S4 Avant [8D5; B5]									
	2.7 Biturbo quattro	MFD 10.97-09.01	195-280		JBH,LLE	0986	480 966	25,4	
					JBH,RLE	0986	480 989	25,4	
		OFD 10.97-05.01	195		JBH,LLE	0986	480 935	25,4	
		11.00-09.01	195-280		JBH,LLE	0986	480 935	25,4	
	2.7 Biturbo quattro	10.97-09.01	195		LLE	0986	486 054	19,05	
		11.00-09.01	195-280	Fg.-Nr. 8D..Y..010 001→	LLE	0986	486 054	19,05	
	2.7 Biturbo quattro	10.97-09.01	195-280			0986	486 548	22,2	
	2.7 Biturbo quattro	10.97-09.01	195-280			0265	202 403^M		
					CS2	0265	220 410^E		
	2.7 Biturbo quattro	10.97-06.99	195	Fg.-Nr. →8D..X..400 000	FMP,GRG	0265	109 426^M		
		07.99-09.01	195	Fg.-Nr. 8D..Y..000 001→	FMP,GRG	0265	109 462^M		
		11.00-09.01	195-280		FMP,GRG	0265	109 462^M		
	2.7 Biturbo quattro	10.97-09.01	195-280			0265	005 162^S		
	2.7 Biturbo quattro	10.97-09.01	195-280			0265	005 207		
						0265	005 214		



		S							
S4 Avant [8ED; B7]									
									
	4.2 quattro	11.04-06.08	253		JBH	0 986 481 006	27		
	4.2 quattro	11.04-06.08	253		LLE	0 986 486 062	19,05		
		01.05-06.08	253			0 986 486 062	19,05		
	4.2 quattro	11.04-06.08	253			0 986 486 548	22,2		
		01.05-06.08	253			0 986 486 583	22,2		
	4.2 quattro	11.04-05.05	253	Fg.-Nr. →8E..5..600 000		0 265 234 329 ^T			
		06.05-06.08	253	Fg.-Nr. 8E..6..000 001→		0 265 234 335 ^T			
	4.2 quattro	11.04-05.05	253	Fg.-Nr. →8E..5..600 000		0 265 005 692			
		06.05-06.08	253	Fg.-Nr. 8E..6..000 001→, PR-Code G0C, PR-Code G0G, PR-Code G0K		0 265 005 619			
				Fg.-Nr. 8E..6..000 001→, PR-Code G0Z		0 265 005 621			
S4 Avant [8E5; B6]									
									
	4.2 quattro	03.03-12.04	253		JBH	0 986 481 006	27		
	4.2 quattro	03.03-12.04	253		LLE	0 986 486 062	19,05		
	4.2 quattro	03.03-12.04	253			0 986 486 548	22,2		
	4.2 quattro	03.03-12.04	253			0 265 225 241 ^T			
	4.2 quattro	03.03-12.04	253			0 265 005 252			
	4.2 quattro	03.03-12.04	253			0 265 005 303			
S4 Avant [8K5; B8]									
									
	3.0 TFSI quattro	03.09-03.12	245		FDS	0 265 005 741			
					FDS	0 265 005 739			
		05.14→	245		TW	0 265 005 741			
S4 Cabriolet [8HE; B7]									
									
	4.2 quattro	01.06-03.09	253		JBH	0 986 481 006	27		
	4.2 quattro	01.06-03.09	253		LLE	0 986 486 062	19,05		
	4.2 quattro	01.06-03.09	253			0 986 486 548	22,2		



		S								
◀ AUDI S4 Cabriolet [8HE; B7]										
	4.2 quattro	01.06-03.09	253					0 265 234 335 ^T		
	4.2 quattro	01.06-03.09	253					0 265 005 621		
	4.2 quattro	01.06-03.09	253					0 265 005 303		
S4 Cabriolet [8H7; B7]										
	4.2 quattro	02.04-06.06	253			JBH		0 986 481 006	27	
	4.2 quattro	02.04-06.06	253			LLE		0 986 486 062	19,05	
	4.2 quattro	02.04-06.06	253					0 986 486 583	22,2	
	4.2 quattro	02.04-06.06	253					0 265 225 241 ^T		
	4.2 quattro	02.04-06.06	253					0 265 005 252		
	4.2 quattro	02.04-06.06	253					0 265 005 303		
S4 [4A2; C4]										
	2.2 quattro	07.92-07.94	169			BVH,JBH,LH		0 986 480 943	25,4	
	4.2 quattro	07.92-07.94	206			BVH,JBH,LH		0 986 480 943	25,4	
	2.2 quattro	07.92-07.94	169					0 986 485 114		
	4.2 quattro	07.92-07.94	206					0 986 485 114		
	2.2 quattro	07.92-07.94	169			RLE		0 986 486 024	19,05	
	2.2 quattro	07.92-07.94	169					0 986 486 532	22,2	
	4.2 quattro	07.92-07.94	206					0 986 486 532	22,2	
	2.2 quattro	07.92-07.94	169					0 265 205 007 ^H		
	4.2 quattro	07.92-07.94	206					0 265 205 007 ^H		
	2.2 quattro	07.92-07.94	169			GS		0 265 103 051 ^H		
		08.92-07.94	169			AG		0 265 103 062 ^H		
	4.2 quattro	07.92-07.94	206			GS		0 265 103 051 ^H		
		08.92-07.94	206			AG		0 265 103 062 ^H		
S4 [8D2; B5]										
	2.7 Biturbo quattro	MFD	10.97-09.01	195		JBH,LLE		0 986 480 966	25,4	
						JBH,RLE		0 986 480 989	25,4	
		OFD	10.97-09.01	195		JBH,LLE		0 986 480 935	25,4	



		S							
	2.7 Biturbo quattro	10.97-10.00	195			LLE	0 986 486 054	19,05	
		11.00-09.01	195		Fg.-Nr. 8D..Y..010 001→	LLE	0 986 486 054	19,05	
	2.7 Biturbo quattro	10.97-09.01	195				0 986 486 548	22,2	
	2.7 Biturbo quattro	10.97-09.01	195				0 265 202 403 ^M		
						CS2	0 265 220 410 ^E		
	2.7 Biturbo quattro	10.97-06.99	195		Fg.-Nr. →8D..X..400 000	FMP,GRG	0 265 109 426 ^M		
		07.99-10.00	195		Fg.-Nr. 8D..Y..000 001→	FMP,GRG	0 265 109 462 ^M		
		11.00-09.01	195			FMP,GRG	0 265 109 462 ^M		
	2.7 Biturbo quattro	10.97-09.01	195				0 265 005 162 ⁵		
	2.7 Biturbo quattro	10.97-09.01	195				0 265 005 207		
							0 265 005 214		
S4 [8EC; B7]									
	4.2 quattro	11.04-06.08	253			JBH	0 986 481 006	27	
	4.2 quattro	11.04-06.08	253			LLE	0 986 486 062	19,05	
	4.2 quattro	11.04-06.08	253				0 986 486 583	22,2	
	4.2 quattro	11.04-05.05	253		Fg.-Nr. →8E..5..600 000		0 265 234 329 ^T		
		06.05-06.08	253		Fg.-Nr. 8E..6..000 001→		0 265 234 335 ^T		
	4.2 quattro	11.04-05.05	253		Fg.-Nr. →8E..5..600 000		0 265 005 692		
		06.05-06.08	253		Fg.-Nr. 8E..6..000 001→, PR-Code G0C, PR-Code G0G, PR-Code G0K		0 265 005 619		
					Fg.-Nr. 8E..6..000 001→, PR-Code G0Z		0 265 005 621		
S4 [8E2; B6]									
	4.2 quattro	03.03-12.04	253			JBH	0 986 481 006	27	
	4.2 quattro	03.03-12.04	253			LLE	0 986 486 062	19,05	
		09.03-08.04	253				0 986 486 062	19,05	
	4.2 quattro	03.03-12.04	253				0 986 486 548	22,2	
		09.03-08.04	253				0 986 486 583	22,2	
	4.2 quattro	03.03-12.04	253				0 265 225 241 ^T		
	4.2 quattro	03.03-12.04	253				0 265 005 252		
	4.2 quattro	03.03-12.04	253				0 265 005 303		



		S							
◀ AUDI									
S4 [8K2; B8]									
	3.0 TFSI quattro	03.09-03.12	245			FDS	0 265 005 741		
						FDS	0 265 005 739		
		05.13→	245			TW	0 265 005 741		
S5 Cabriolet [8F7]									
	3.0 TFSI quattro	05.09-06.14	245			FDS	0 265 005 741		
						FDS	0 265 005 739		
		05.14→	245				0 265 005 739		
							0 265 005 741		
S5 Coupé [8T3]									
	3.0 TFSI quattro	09.11→	245			NAD	0 265 005 741		
		09.12-08.13				NAD	0 265 005 741		
		05.13→	265			FDS	0 265 005 741		
		05.14→	245				0 265 005 739		
							0 265 005 741		
		OAD 09.11→	245				0 265 005 739		
		09.12-08.13					0 265 005 739		
		05.13→	265				0 265 005 739		
	4.2 quattro	06.07-09.08	260				0 265 005 739		
		06.07-03.12	260			FDS	0 265 005 741		
		10.08-03.12	260				0 265 005 739		
S5 Sportback [8TA]									
	3.0 TFSI quattro	01.10-03.12	245			FDS	0 265 005 741		
						FDS	0 265 005 739		
		09.11→	245			NAD	0 265 005 741		
		05.13→	265			FDS	0 265 005 741		
		05.14→	245				0 265 005 739		
							0 265 005 741		
		OAD 09.11→	245				0 265 005 739		
		05.13→	265				0 265 005 739		
S6 Avant [4A5; C4]									
	2.2 T quattro	06.94-07.97	169				0 986 485 114		
	4.2 Plus quattro, quattro	09.94-10.97	213/240				0 986 485 114		
	2.2 T quattro	06.94-07.97	169				0 986 486 532	22,2	
	4.2 Plus quattro, quattro	09.94-10.97	213/240				0 986 486 532	22,2	
	2.2 T quattro	06.94-07.97	169				0 265 218 022 ^J		
	4.2 Plus quattro, quattro	09.94-10.97	213/240				0 265 218 022 ^J		
	2.2 T quattro	06.94-07.97	169			GS	0 265 109 031 ^J		
	4.2 Plus quattro	06.96-10.97	240				0 265 109 031 ^J		
	4.2 quattro	09.94-07.97	213			GS	0 265 109 031 ^J		



		S								
S6 Avant [4B; C5]										
	4.2 quattro	MFD 09.99-05.01	250				JBH	0 986 480 966	25,4	
		OFD 09.99-05.01	250				JBH	0 986 480 935	25,4	
	4.2 quattro	09.99-05.01	250				LLE	0 986 486 054	19,05	
	4.2 quattro	09.99-05.01	250					0 986 486 548	22,2	
	4.2 quattro	09.99-05.01	250					0 265 202 403 ^M		
								0 265 225 088 ^T		
							CS2	0 265 220 410 ^E		
	4.2 quattro	09.99-05.01	250				CFG,GAE	0 265 109 473 ^M		
	4.2 quattro	09.99-05.01	250					0 265 005 214		
S6 Avant [4B6; C5]										
	4.2 quattro	06.01-01.05	250				JBH GIR	0 986 481 046	25,4	
	4.2 quattro	06.01-01.05	250				LLE	0 986 486 061	19,05	
	4.2 quattro	06.01-01.05	250					0 986 486 548	22,2	
	4.2 quattro	06.01-01.05	250					0 265 225 088 ^T		
	4.2 quattro	06.01-01.05	250					0 265 005 252		
S6 Avant [4F5; C6]										
	5.2 FSI quattro	06.06-08.11	320				JBH	0 986 481 006	27	
	5.2 FSI quattro	06.06-05.08	320			Fg.-Nr. →4F..8..152 360		0 265 005 692		
		06.08-08.11	320			Fg.-Nr. 4F..8..152 361→		0 265 005 777		
S6 [4A2; C4]										
	2.2 T quattro	06.94-07.97	169					0 986 485 114		
	4.2 Plus quattro, quattro	09.94-10.97	213/240					0 986 485 114		
	2.2 T quattro	06.94-07.97	169					0 986 486 532	22,2	
	4.2 Plus quattro, quattro	09.94-10.97	213/240					0 986 486 532	22,2	



			S								
◀ AUDI S6 [4A2; C4]											
	2.2 T quattro	06.94-07.97	169						0 265 218 022 ^J		
	4.2 Plus quattro, quattro	09.94-10.97	213/240						0 265 218 022 ^J		
	2.2 T quattro	06.94-07.97	169				GS		0 265 109 031 ^J		
	4.2 Plus quattro	06.96-10.97	240						0 265 109 031 ^J		
	4.2 quattro	09.94-07.97	213				GS		0 265 109 031 ^J		
S6 [4B4; C5]											
	4.2 quattro	06.01-05.04	250				JBH	GIR	0 986 481 046	25,4	
		MFD 09.99-05.01	250				JBH		0 986 480 966	25,4	
		OFD 09.99-05.01	250				JBH		0 986 480 935	25,4	
	4.2 quattro	09.99-05.01	250				LLE		0 986 486 054	19,05	
		06.01-05.04	250				LLE		0 986 486 061	19,05	
	4.2 quattro	09.99-05.04	250						0 986 486 548	22,2	
	4.2 quattro	09.99-05.01	250						0 265 202 403 ^M		
							CS2		0 265 220 410 ^E		
		09.99-05.04	250						0 265 225 088 ^T		
	4.2 quattro	09.99-05.01	250				CFG,GAE		0 265 109 473 ^M		
	4.2 quattro	09.99-05.01	250						0 265 005 214		
		06.01-05.04	250						0 265 005 252		
S6 [4F2; C6]											
	5.2 FSI quattro	06.06-08.11	320				JBH		0 986 481 006	27	
	5.2 FSI quattro	06.06-05.08	320			Fg.-Nr. →4F..8..152 360			0 265 005 692		
		06.08-08.11	320			Fg.-Nr. 4F..8..152 361→			0 265 005 777		
S8 [4D2]											
	4.2 quattro	MFD 09.96-12.98	250				JBH		0 986 480 966	25,4	
		05.99-09.02	265				JBH		0 986 480 966	25,4	
		OFD 09.96-12.98	250				JBH		0 986 480 935	25,4	
		05.99-09.02	265				JBH		0 986 480 935	25,4	
	4.2 quattro	09.96-12.98	250						0 265 202 403 ^M		
							CS2		0 265 220 410 ^E		
		05.99-09.02	265						0 265 202 403 ^M		
							CS2		0 265 220 410 ^E		
	4.2 quattro	09.96-10.98	250			Fg.-Nr. →4D..X..004 999	GRG		0 265 109 400 ^M		
		10.98-12.98	250			Fg.-Nr. 4D..X..005 001→	CFG		0 265 109 443 ^M		
		05.99-09.02	265				CFG		0 265 109 460 ^M		
	4.2 quattro	09.96-12.98	250						0 265 005 162 ^S		
		05.99-09.02	265						0 265 005 162 ^S		
	4.2 quattro	09.96-12.98	250						0 265 005 207		
		05.99-09.02	265						0 265 005 207		



		S								
	4.2 quattro	05.99-09.02	265						0 265 005 303	
S8 [4E2]										
	5.2 FSI quattro	06.06-05.08	331	Fg.-Nr. →4E..8..030 000					0 265 225 374 ^T	
	5.2 FSI quattro	06.06-07.10	331						0 265 005 252	
	5.2 FSI quattro	06.06-07.10	331						0 265 005 303	
TT Coupé [8J3]										
	2.0 TDI quattro, TFSI, TFSI quattro	07.06-06.14	125/147/ 155	PR-Code 0EN					0 986 486 595	29
	3.2 quattro	07.06-06.10	184	PR-Code 0EN					0 986 486 595	29
TT Coupé [8N3]										
	1.8 T	MFD 01.01-10.01	110	Fg.-Nr. →8N..2..014 300	JBH,LLE	0 986 481 022	23,81			
		OFD 01.01-10.01	110	Fg.-Nr. →8N..2..014 300	LLE	F 026 003 339	23,81			
					RLE	0 204 123 406	23,81			
	1.8 T	MFD 07.98-08.01	132/165		JBH,LLE	0 986 481 022	23,81			
	1.8 T quattro	09.00-10.01	132/165	Fg.-Nr. →8N..2..014 300	JBH,LLE	0 986 481 022	23,81			
		OFD 07.98-08.01	132/165		LLE	F 026 003 339	23,81			
					RLE	0 204 123 406	23,81			
		09.00-10.01	132/165	Fg.-Nr. →8N..2..014 300	LLE	F 026 003 339	23,81			
					RLE	0 204 123 406	23,81			
	1.8 T	EAR 01.01-10.01	110	Fg.-Nr. →8N..2..014 300	RLE	0 204 125 505				
	1.8 T	EAR 07.98-08.01	132/165		RLE	0 204 125 505				
	1.8 T quattro	09.00-10.01	132/165	Fg.-Nr. →8N..2..014 300	RLE	0 204 125 505				
	1.8 T	07.98-06.06	132		LLE	0 986 486 031	15,87			
		09.00-06.06	132			0 986 486 031	15,87			
		01.01-08.02	110		RLE	0 986 486 047	15,87			
		01.01-06.06	110		LLE	0 986 486 031	15,87			
		09.02-06.06	110		RLE	0 986 486 060	15,87			
		09.05-06.06	120		LLE	0 986 486 031	15,87			
					RLE	0 986 486 060	15,87			
	1.8 T quattro	07.98-08.02	165		RLE	0 986 486 047	15,87			
		07.98-06.06	132		LLE	0 986 486 031	15,87			
			165		LLE	0 986 486 031	15,87			
		03.00-08.02	165			0 986 486 031	15,87			
		09.02-06.06	165		RLE	0 986 486 060	15,87			
		03.05-06.06	180		LLE	0 986 486 031	15,87			
					RLE	0 986 486 060	15,87			
	1.8 T	07.98-08.02	132		RLE	0 986 486 047	15,87			
	1.8 T quattro	09.02-06.06	132		RLE	0 986 486 060	15,87			
		09.05-06.06	140		LLE	0 986 486 031	15,87			
					RLE	0 986 486 060	15,87			
	3.2 quattro	07.03-06.06	184		LLE	0 986 486 031	15,87			
					RLE	0 986 486 060	15,87			



		S								
◀ AUDI TT Coupé [8N3]										
	1.8 T	07.98-08.02	132				0 986 486 538	19		
		01.01-08.02	110				0 986 486 538	19		
	1.8 T quattro	07.98-05.05	132				0 986 486 595	29		
		07.98-06.06	140/165				0 986 486 595	29		
3.2 quattro	07.03-06.06	184				0 986 486 595	29			
TT Roadster [8J9]										
	2.0 TDI quattro, TFSI, TFSI Convertible quattro, TFSI quattro	02.07-06.14	125/147/155	PR-Code OEN			0 986 486 595	29		
		02.07-06.10	184	PR-Code OEN			0 986 486 595	29		
	3.2 quattro	09.07-08.09	184				0 986 486 595	29		
TT Roadster [8N9]										
	1.8 T	MFD 01.01-10.01	110	Fg.-Nr. →8N..2..014 300	JBH,LLE		0 986 481 022	23,81		
		OFD 01.01-10.01	110	Fg.-Nr. →8N..2..014 300	LLE	F 026	003 339	23,81		
					RLE	0 204	123 406	23,81		
	1.8 T quattro	MFD 03.99-10.01	132/165		JBH,LLE		0 986 481 022	23,81		
		OFD 03.99-10.01	132/165		LLE	F 026	003 339	23,81		
					RLE	0 204	123 406	23,81		
	1.8 T	EAR 01.01-10.01	110	Fg.-Nr. →8N..2..014 300	RLE	0 204	125 505			
	1.8 T, T quattro	EAR 03.99-10.01	132/165		RLE	0 204	125 505			
	1.8 T	01.01-08.02	110		RLE	0 986	486 047	15,87		
		01.01-06.06	110		LLE	0 986	486 031	15,87		
		09.02-06.06	110		RLE	0 986	486 060	15,87		
		09.05-06.06	120		LLE	0 986	486 031	15,87		
					RLE	0 986	486 060	15,87		
	1.8 T quattro	03.99-08.02	165		RLE	0 986	486 047	15,87		
		03.99-06.06	165		LLE	0 986	486 031	15,87		
		03.00-05.06	165			0 986	486 031	15,87		
		09.02-06.06	165		RLE	0 986	486 060	15,87		
							0 986	486 047	15,87	
	1.8 T	04.99-08.02	132		RLE	0 986	486 047	15,87		
		1.8 T quattro	04.99-06.06	132		LLE	0 986	486 031	15,87	
			11.99-08.02	132			0 986	486 031	15,87	
			09.02-06.06	132		RLE	0 986	486 060	15,87	
			09.05-06.06	140		LLE	0 986	486 031	15,87	
	3.2 quattro	07.03-06.06	184		RLE	0 986	486 060	15,87		
					LLE	0 986	486 031	15,87		
					RLE	0 986	486 060	15,87		
					LLE	0 986	486 031	15,87		
					RLE	0 986	486 060	15,87		
	1.8 T	04.99-08.02	132			0 986 486 538	19			
		01.01-08.02	110			0 986 486 538	19			
	1.8 T quattro	03.99-06.06	140/165			0 986 486 595	29			
		07.99-05.05	132			0 986 486 595	29			
	3.2 quattro	07.03-06.06	184			0 986 486 595	29			
	TT RS Coupé [8J3]									
	2.5 TFSI quattro	07.09-06.14	250/265				0 986 486 595	29		



		S							
TT RS Roadster [8J9]									
	2.5 TFSI quattro	07.09-06.14	250/265				0 986 486 595	29	
TTS Coupé [8J3]									
	2.0 TFSI quattro	05.08-06.14	195/200				0 986 486 595	29	
TTS Roadster [8J9]									
	2.0 TFSI quattro	05.08-06.14	195/200				0 986 486 595	29	
80 Avant [8C5; B4]									
	1.6	ABO 06.93-07.95	74			JBH,LLE	0 986 480 911	23	
						JBH,RLE	0 986 480 838	22,2	
		ABS 06.93-07.95	74			JBH	0 986 480 832	23,8	
	1.9 TD	ABO 08.92-07.95	55/66			JBH,LLE	0 986 480 911	23	
	1.9 TDI					JBH,RLE	0 986 480 838	22,2	
		ABS 08.92-07.95	55/66			JBH	0 986 480 832	23,8	
	2.0	ABO 08.92-07.95	66/79/85/			JBH,LLE	0 986 480 911	23	
	2.0 E		103			JBH,RLE	0 986 480 838	22,2	
		ABS 08.92-07.95	66/79/85/103			JBH	0 986 480 832	23,8	
	2.0 quattro	11.93-07.95	79				0 986 480 829	23,8	
		07.94-07.95	103			LLE	0 986 480 829	23,8	
	2.2 S2 quattro	07.94-07.95	169			JBH	0 986 480 943	25,4	
	2.3 E	ABO 08.92-11.94	98			JBH,LLE	0 986 480 911	23	
						JBH,RLE	0 986 480 838	22,2	
		ABS 08.92-11.94	98			JBH	0 986 480 832	23,8	
	2.3 quattro	08.92-06.94	98			JBH	0 986 480 911	23	
		07.94-11.94	98				0 986 480 829	23,8	
	2.6 E	08.92-05.95	110			JBH	0 986 480 832	23,8	
		05.93-05.95	102			JBH	0 986 480 832	23,8	
	2.6 quattro	08.92-07.95	110			LLE	0 986 480 829	23,8	
		11.93-05.95	102				0 986 480 829	23,8	
	2.8 E	08.92-05.95	128			JBH	0 986 480 832	23,8	
	2.8 quattro	08.92-07.95	128			LLE	0 986 480 829	23,8	
	1.6	06.93-07.95	74				0 986 486 015	19,05	
	1.9 TD, TDI	08.92-07.95	55/66				0 986 486 015	19,05	
	2.0, E, quattro	08.92-07.95	66/79/85/103				0 986 486 015	19,05	
	2.3 E, quattro	08.92-11.94	98				0 986 486 015	19,05	
	2.6 E, quattro	08.92-07.95	102/110				0 986 486 015	19,05	
	2.8 E, quattro	08.92-07.95	128				0 986 486 015	19,05	
	1.6	06.93-07.95	74				0 986 486 532	22,2	
	1.9 TD, TDI	08.92-07.95	55/66				0 986 486 532	22,2	
	2.0, E, quattro	08.92-07.95	66/79/85/103				0 986 486 532	22,2	
	2.2 S2 quattro	07.94-07.95	169				0 986 486 532	22,2	
	2.3 E, quattro	08.92-11.94	98				0 986 486 532	22,2	
	2.6 E, quattro	08.92-07.95	102/110				0 986 486 532	22,2	
	2.8 E, quattro	08.92-07.95	128				0 986 486 532	22,2	



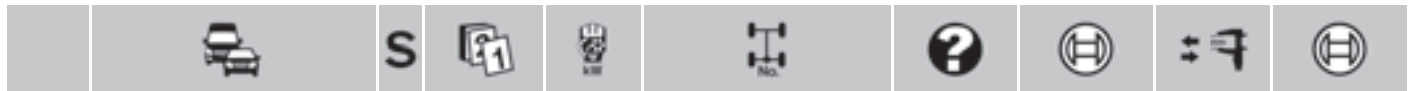













◀ AUDI 80 Avant [8C5; B4]

	1.6	06.93-07.95	74	0 986 482 039 ^A	
	1.9 TD, TDI	08.92-07.95	55/66	0 986 482 039 ^A	
	2.0, E	08.92-07.95	66/79/85/103	0 986 482 039 ^A	
	2.3 E	08.92-11.94	98	0 986 482 039 ^A	
	2.6 E	08.92-05.95	102/110	0 986 482 039 ^A	
	2.8 E	08.92-05.95	128	0 986 482 039 ^A	
	1.6	06.93-07.95	74	0 265 201 050 ^H	
				0 265 211 006 ^K	
	1.9 TD, TDI	08.92-07.95	55/66	0 265 201 050 ^H	
	2.0	08.92-06.95	66	0 265 201 050 ^H	
		08.92-07.95	103	0 265 211 006 ^K	
				0 265 201 050 ^H	
				0 265 211 006 ^K	
	2.0 E	08.92-07.95	85	0 265 201 050 ^H	
		11.93-06.95	79	0 265 211 006 ^K	
				0 265 201 050 ^H	
				0 265 211 006 ^K	
	2.0 quattro	11.93-07.95	79	0 265 205 007 ^H	
		07.94-07.95	103	0 265 205 007 ^H	
	2.2 RS2 quattro, S2 quattro	03.94-07.95	169/232	0 265 205 007 ^H	
	2.3 E	08.92-11.94	98	0 265 201 050 ^H	
				0 265 211 006 ^K	
	2.3 quattro	08.92-11.94	98	0 265 205 007 ^H	
	2.6 E	08.92-05.95	102/110	0 265 201 050 ^H	
			0 265 211 006 ^K		
2.6 quattro	08.92-07.95	102/110	0 265 205 007 ^H		
2.8 E	08.92-05.95	128	0 265 201 050 ^H		
			0 265 211 006 ^K		
2.8 quattro	08.92-07.95	128	0 265 205 007 ^H		
	1.6	06.93-07.95	74	0 265 100 057 ^H	
				0 265 104 006 ^K	
	1.9 TD	08.92-07.95	55/66	0 265 100 057 ^H	
	1.9 TDI			0 265 104 006 ^K	
	2.0, E	08.92-07.95	66/79/85/103	0 265 104 006 ^K	
	2.0, E, quattro	08.92-07.95	66/79/85/103	0 265 100 057 ^H	
	2.2 RS2 quattro	03.94-07.95	232	0 265 103 051 ^H	
	2.2 S2 quattro	07.94-07.95	169	0 265 100 057 ^H	
	2.3 E	08.92-11.94	98	0 265 104 006 ^K	
	2.3 E, quattro	08.92-11.94	98	0 265 100 057 ^H	
	2.6 E	08.92-05.95	102/110	0 265 104 006 ^K	
	2.6 E, quattro	08.92-07.95	102/110	0 265 100 057 ^H	
	2.8 E	08.92-05.95	128	0 265 104 006 ^K	
	2.8 E, quattro	08.92-07.95	128	0 265 100 057 ^H	

80 [8C2; B4]

	1.6	ABO	01.92-05.95	52/74	JBH, LLE	0 986 480 911	23	
					JBH, RLE	0 986 480 838	22,2	
		ABS	01.92-05.95	52/74	JBH	0 986 480 832	23,8	
	1.9 TD	ABO	09.91-05.95	55/66	JBH, LLE	0 986 480 911	23	
		1.9 TDI			JBH, RLE	0 986 480 838	22,2	
	2.0	ABO	09.91-05.95	55/66	JBH	0 986 480 832	23,8	
		ABO	08.92-05.95	103	JBH, LLE	0 986 480 911	23	
	2.0				JBH, RLE	0 986 480 838	22,2	
		ABO	09.91-05.95	66/79/85	JBH, LLE	0 986 480 911	23	
	2.0 E				JBH, RLE	0 986 480 838	22,2	
		ABS	09.91-05.95	66/79/85/103	JBH	0 986 480 832	23,8	
	2.0 quattro		08.92-06.94	85	Fg.-Nr. 8C..P..000 001→	JBH	0 986 480 911	23
				103		JBH, LLE	0 986 480 911	23

		S								
2.0 quattro		11.93-05.95	79				0 986 480 829	23,8		
		07.94-12.94	85				0 986 480 829	23,8		
		07.94-05.95	103			LLE	0 986 480 829	23,8		
2.2 S2 quattro		02.93-05.95	169			JBH	0 986 480 943	25,4		
2.3	ABO	09.90-11.94	98			JBH,LLE	0 986 480 911	23		
						JBH,RLE	0 986 480 838	22,2		
2.3 quattro	ABS	09.90-11.94	98			JBH	0 986 480 832	23,8		
		08.92-06.94	98	Fg.-Nr. 8C..P..000 001→		JBH	0 986 480 911	23		
2.6 E		07.92-05.95	110			JBH	0 986 480 832	23,8		
		05.93-05.95	102			JBH	0 986 480 832	23,8		
2.6 quattro		07.92-05.95	110			LLE	0 986 480 829	23,8		
		11.93-05.95	102				0 986 480 829	23,8		
2.8 E		09.91-05.95	128			JBH	0 986 480 832	23,8		
2.8 quattro		09.91-05.95	128			LLE	0 986 480 829	23,8		
 2.3 quattro		09.91-11.94	98			HY	0 986 485 114			
	1.6	01.92-05.95	52/74				0 986 486 015	19,05		
	1.9 TD, TDI	09.91-05.95	55/66				0 986 486 015	19,05		
	2.0, E, quattro	09.91-05.95	66/79/85/103				0 986 486 015	19,05		
	2.3, quattro	09.90-11.94	98				0 986 486 015	19,05		
	2.6 E, quattro	07.92-05.95	102/110				0 986 486 015	19,05		
	2.8 E, quattro	09.91-05.95	128				0 986 486 015	19,05		
	1.6	01.92-05.95	52/74				0 986 486 532	22,2		
	1.9 TD, TDI	09.91-05.95	55/66				0 986 486 532	22,2		
	2.0, E, quattro	09.91-05.95	66/79/85/103				0 986 486 532	22,2		
	2.2 S2 quattro	02.93-05.95	169				0 986 486 532	22,2		
	2.3, quattro	09.90-11.94	98				0 986 486 532	22,2		
	2.6 E, quattro	07.92-05.95	102/110				0 986 486 532	22,2		
	2.8 E, quattro	09.91-05.95	128				0 986 486 532	22,2		
	1.6	01.92-05.95	52/74				0 986 482 039 ^A			
	1.9 TD, TDI	09.91-05.95	55/66				0 986 482 039 ^A			
	2.0, E	09.91-05.95	66/79/85/103				0 986 482 039 ^A			
	2.3	09.90-11.94	98				0 986 482 039 ^A			
	2.6 E	07.92-05.95	102/110				0 986 482 039 ^A			
	2.8 E	09.91-05.95	128				0 986 482 039 ^A			
	1.6	01.92-05.95	52/74				0 265 201 050 ^H			
							0 265 211 006 ^K			
	1.9 TD	09.91-05.95	55/66				0 265 201 050 ^H			
	1.9 TDI						0 265 211 006 ^K			
	2.0	09.91-05.95	66				0 265 201 050 ^H			
							0 265 211 006 ^K			
	2.0	09.91-05.95	79/85/103				0 265 201 050 ^H			
	2.0 E						0 265 211 006 ^K			
	2.0 quattro	09.91-05.95	79/85/103				0 265 205 007 ^H			
	2.2 S2 quattro	02.93-05.95	169				0 265 205 007 ^H			
	2.3		09.90-11.94	98				0 265 201 050 ^H		
								0 265 211 006 ^K		
	2.3 quattro	09.91-11.94	98				0 265 205 007 ^H			
	2.6 E	07.92-05.95	102/110				0 265 201 050 ^H			
							0 265 211 006 ^K			
	2.6 quattro	07.92-05.95	102/110				0 265 205 007 ^H			
	2.8 E		09.91-05.95	128				0 265 201 050 ^H		
								0 265 211 006 ^K		
	2.8 quattro	09.91-05.95	128				0 265 205 007 ^H			



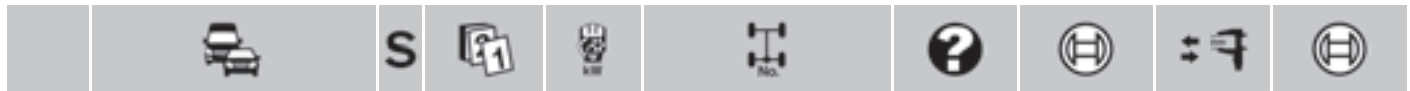

◀ AUDI 80 [8C2; B4]

	1.6	01.92-08.94	52		0 265 104 006 ^K	
		08.92-08.94	52	Fg.-Nr. 8C..P..000 001→	0 265 100 057 ^H	
		06.93-05.95	74		0 265 100 057 ^H	
					0 265 104 006 ^K	
	1.9 TD	09.91-05.95	55/66		0 265 104 006 ^K	
	1.9 TDI	08.92-05.95	55/66	Fg.-Nr. 8C..P..000 001→	0 265 100 057 ^H	
	2.0	09.91-05.95	66		0 265 104 006 ^K	
		08.92-05.95	66	Fg.-Nr. 8C..P..000 001→	0 265 100 057 ^H	
			103		0 265 104 006 ^K	
	2.0, quattro	08.92-05.95	103		0 265 100 057 ^H	
	2.0 E	08.92-05.95	85	Fg.-Nr. 8C..P..000 001→	0 265 104 006 ^K	
		07.94-05.95	79		0 265 104 006 ^K	
	2.0 E	08.92-05.95	85	Fg.-Nr. 8C..P..000 001→	0 265 100 057 ^H	
	2.0 quattro	11.93-05.95	79		0 265 100 057 ^H	
	2.2 S2 quattro	02.93-05.95	169		0 265 100 057 ^H	
	2.3	08.92-11.94	98	Fg.-Nr. 8C..P..000 001→	0 265 104 006 ^K	
	2.3, quattro	08.92-11.94	98	Fg.-Nr. 8C..P..000 001→	0 265 100 057 ^H	
	2.6 E	07.92-05.95	102/110		0 265 104 006 ^K	
	2.6 E, quattro	07.92-05.95	102/110		0 265 100 057 ^H	
	2.8 E	08.92-05.95	128	Fg.-Nr. 8C..P..000 001→	0 265 104 006 ^K	
	2.8 E, quattro	08.92-05.95	128	Fg.-Nr. 8C..P..000 001→	0 265 100 057 ^H	

90 [89; 8A2; B3]



	2.8	01.92-05.95	128		0 265 211 006 ^K	
		08.92-05.95	128		0 265 201 050 ^H	

100 Avant [4A5; C4]



	2.0	ABO 07.92-07.94	79/85/103	JBH	0 986 480 911	23	
		ABS 07.92-07.94	79/85/103	JBH	0 986 480 832	23,8	
	2.3	ABO 08.91-07.94	98	JBH	0 986 480 911	23	
		ABS 08.91-07.94	98	JBH	0 986 480 832	23,8	
	2.3 quattro	12.90-07.94	98		0 986 480 829	23,8	
	2.4 D	ABO 08.91-07.94	60	JBH	0 986 480 911	23	
		ABS 08.91-07.94	60	JBH	0 986 480 832	23,8	
	2.5 TDI	ABO 08.91-07.94	85	JBH	0 986 480 911	23	
		ABS 08.91-07.94	85	JBH	0 986 480 832	23,8	
	2.6	ABO 07.92-07.94	102/110	JBH	0 986 480 911	23	
		ABS 07.92-07.94	102/110	JBH	0 986 480 832	23,8	
	2.6 quattro	03.92-07.94	110		0 986 480 829	23,8	
	2.8	ABO 08.91-07.94	125-128	JBH	0 986 480 911	23	
		ABS 08.91-07.94	125-128	JBH	0 986 480 832	23,8	
	2.8 quattro	12.90-07.94	128		0 986 480 829	23,8	
	2.0	07.92-07.94	79/85/103	RLE	0 986 486 024	19,05	
		2.3, quattro	12.90-07.94	98	RLE	0 986 486 024	19,05
		2.4 D	08.91-07.94	60	RLE	0 986 486 024	19,05
		2.5 TDI	08.91-07.94	85	RLE	0 986 486 024	19,05
		2.6, quattro	03.92-07.94	102/110	RLE	0 986 486 024	19,05
		2.8, quattro	12.90-07.94	125-128	RLE	0 986 486 024	19,05
	2.0	07.92-07.94	79/85/103		0 986 486 532	22,2	
		2.3, quattro	12.90-07.94	98		0 986 486 532	22,2
		2.4 D	08.91-07.94	60		0 986 486 532	22,2
		2.5 TDI	08.91-07.94	85		0 986 486 532	22,2
		2.6, quattro	03.92-07.94	102/110		0 986 486 532	22,2
		2.8, quattro	12.90-07.94	125-128		0 986 486 532	22,2



	2.0	07.92-07.94	79/85/103		NIV	0 986 482 008 ^A	
	2.3	08.91-07.94	98		NIV	0 986 482 008 ^A	
	2.4D	08.91-07.94	60		NIV	0 986 482 008 ^A	
	2.5 TDI	08.91-07.94	85		NIV	0 986 482 008 ^A	
	2.6	07.92-07.94	102/110		NIV	0 986 482 008 ^A	
	2.8	08.91-07.94	125-128		NIV	0 986 482 008 ^A	

	2.0	07.92-07.94	79/85/103			0 265 201 050 ^H	
						0 265 211 006 ^K	
	2.3	08.91-07.94	98			0 265 201 050 ^H	
						0 265 211 006 ^K	
	2.3 quattro	12.90-07.94	98			0 265 205 007 ^H	
	2.4D	08.91-07.94	60			0 265 201 050 ^H	
						0 265 211 006 ^K	
	2.5 TDI	08.91-07.94	85			0 265 201 050 ^H	
						0 265 211 006 ^K	
	2.6	07.92-07.94	110			0 265 201 050 ^H	
						0 265 211 006 ^K	
		07.93-07.94	102			0 265 201 050 ^H	
						0 265 211 006 ^K	
	2.6 quattro	03.92-07.94	110			0 265 205 007 ^H	

	2.0	08.92-07.94	79/85/103			0 265 100 057 ^H	
						0 265 104 006 ^K	
	2.3	08.92-07.94	98			0 265 100 057 ^H	
						0 265 104 006 ^K	
	2.3 quattro	12.90-07.94	98		AG	0 265 103 062 ^H	
					GS	0 265 103 051 ^H	
	2.4D	08.92-07.94	60			0 265 100 057 ^H	
						0 265 104 006 ^K	
	2.5 TDI	08.92-07.94	85			0 265 100 057 ^H	
						0 265 104 006 ^K	
	2.6	08.92-07.94	110			0 265 100 057 ^H	
						0 265 104 006 ^K	
		07.93-07.94	102			0 265 100 057 ^H	
						0 265 104 006 ^K	

100 [4A2; C4]

	1.6	ABO	03.92-01.94	75		JBH	0 986 480 911	23
		ABS	03.92-01.94	75		JBH	0 986 480 832	23,8
	2.0	ABO	12.90-07.94	74/79/85/103		JBH	0 986 480 911	23
		ABS	12.90-07.94	74/79/85/103		JBH	0 986 480 832	23,8
	2.3	ABO	12.90-07.94	98		JBH	0 986 480 911	23
		ABS	12.90-07.94	98		JBH	0 986 480 832	23,8
	2.3 quattro		12.90-07.94	98			0 986 480 829	23,8
	2.4D	ABO	05.91-07.94	60		JBH	0 986 480 911	23
		ABS	05.91-07.94	60		JBH	0 986 480 832	23,8
	2.5 TDI	ABO	08.91-07.94	85		JBH	0 986 480 911	23
		ABS	08.91-07.94	85		JBH	0 986 480 832	23,8
	2.6	ABO	04.92-07.94	102/110		JBH	0 986 480 911	23
		ABS	04.92-07.94	102/110		JBH	0 986 480 832	23,8



		S							
	◀ AUDI 100 [4A2; C4]								
	2.6 quattro	03.92-07.94	110				0986 480 829	23,8	
	2.8	ABO 12.90-07.94	128			JBH	0986 480 911	23	
		ABS 12.90-07.94	128			JBH	0986 480 832	23,8	
	2.8 quattro	12.90-07.94	128				0986 480 829	23,8	
	1.6	03.92-01.94	75			RLE	0986 486 024	19,05	
	2.0, quattro	12.90-07.94	74/79/85/103			RLE	0986 486 024	19,05	
	2.3, quattro	12.90-07.94	98			RLE	0986 486 024	19,05	
	2.4 D	05.91-07.94	60			RLE	0986 486 024	19,05	
	2.5 TDI	08.91-07.94	85			RLE	0986 486 024	19,05	
	2.6, quattro	03.92-07.94	102/110			RLE	0986 486 024	19,05	
	2.8, quattro	12.90-07.94	128			RLE	0986 486 024	19,05	
	1.6	03.92-01.94	75				0986 486 532	22,2	
	2.0, quattro	12.90-07.94	74/79/85/103				0986 486 532	22,2	
	2.3, quattro	12.90-07.94	98				0986 486 532	22,2	
	2.4 D	05.91-07.94	60				0986 486 532	22,2	
	2.5 TDI	08.91-07.94	85				0986 486 532	22,2	
	2.6, quattro	03.92-07.94	102/110				0986 486 532	22,2	
	2.8, quattro	12.90-07.94	128				0986 486 532	22,2	
	1.6	03.92-01.94	75			NW	0986 482 008 ^A		
	2.0	12.90-07.94	74/79/85/103			NW	0986 482 008 ^A		
	2.3	12.90-07.94	98			NW	0986 482 008 ^A		
	2.4 D	05.91-07.94	60			NW	0986 482 008 ^A		
	2.5 TDI	08.91-07.94	85			NW	0986 482 008 ^A		
	2.6	04.92-07.94	102/110			NW	0986 482 008 ^A		
	2.8	12.90-07.94	128			NW	0986 482 008 ^A		
	1.6	03.92-01.94	75				0265 201 050 ^H		
							0265 211 006 ^K		
	2.0	12.90-07.94	74/79/85				0265 201 050 ^H		
							0265 211 006 ^K		
		01.92-07.94	103				0265 201 050 ^H		
							0265 211 006 ^K		
	2.0 quattro	01.92-07.94	103				0265 205 007 ^H		
	2.3	12.90-07.94	98				0265 201 050 ^H		
							0265 211 006 ^K		
	2.3 quattro	12.90-07.94	98				0265 205 007 ^H		
	2.4 D	05.91-07.94	60				0265 201 050 ^H		
							0265 211 006 ^K		
	2.5 TDI	08.91-07.94	85				0265 201 050 ^H		
							0265 211 006 ^K		
	2.6	04.92-07.94	110				0265 201 050 ^H		
							0265 211 006 ^K		
		01.93-07.94	102				0265 201 050 ^H		
							0265 211 006 ^K		
	2.6 quattro	03.92-07.94	110				0265 205 007 ^H		
	2.8	12.90-07.94	128				0265 201 050 ^H		
							0265 211 006 ^K		
	2.8 quattro	12.90-07.94	128				0265 205 007 ^H		
	1.6	03.92-01.94	75				0265 100 057 ^H		
							0265 104 006 ^K		
	2.0	08.92-07.94	74/79/85				0265 100 057 ^H		
							0265 104 006 ^K		
			103				0265 100 057 ^H		
							0265 104 006 ^K		
	2.0 quattro	01.92-07.94	103			AG	0265 103 062 ^H		
						GS	0265 103 051 ^H		
	2.2 E	01.92-12.98	96				0265 100 038 ^H		



2.3	08.92-07.94	98				0 265 100 057 ^H		
						0 265 104 006 ^K		
2.3 quattro	12.90-07.94	98			AG	0 265 103 062 ^H		
					GS	0 265 103 051 ^H		
2.4D	08.92-07.94	60				0 265 100 057 ^H		
						0 265 104 006 ^K		
2.5 TDI	08.92-07.94	85				0 265 100 057 ^H		
						0 265 104 006 ^K		
2.6	08.92-07.94	110				0 265 100 057 ^H		
						0 265 104 006 ^K		
	01.93-07.94	102				0 265 100 057 ^H		
						0 265 104 006 ^K		
2.6 E	01.92-12.98	110				0 265 100 057 ^H		
2.6 quattro	03.92-07.94	110			AG	0 265 103 062 ^H		
					GS	0 265 103 051 ^H		
2.8	08.92-07.94	128				0 265 100 057 ^H		
						0 265 104 006 ^K		
2.8 quattro	12.90-07.94	128			AG	0 265 103 062 ^H		
					GS	0 265 103 051 ^H		

AUTOBIANCHI

Y 10 [R.92]

	1.1 i.e., i.e. ECVT, i.e. Selectronic, i.e. 4x4	09.92-12.95	37/40		JBH	F 026 003 262	20,6
	1.3 i.e.	09.92-12.95	53		JBH	F 026 003 262	20,6
	1.1 i.e., i.e. ECVT, i.e. Selectronic, i.e. 4x4	09.92-12.95	37/40			0 204 125 371	
	1.3 i.e.	09.92-12.95	53			0 204 125 371	
	1.1 i.e. ECVT	02.95-12.95	40			0 204 131 223	
	1.1 i.e., i.e. Selectronic	09.92-01.95	37			0 204 131 223	
	1.1 i.e. 4x4	09.92-01.95	37			0 204 131 226	
	1.3 i.e.	09.92-12.95	53			0 204 131 223	

BENTLEY

Continental Flying Spur

	6.0	03.05-05.13	412		TW	0 265 235 393 ^T	
	6.0	03.05-05.13	412	Fg.-Nr. →3W..7..051 365		0 265 005 252	
				Fg.-Nr. 3W..8..051 366→3W..8..059 514		0 265 005 777	
				Fg.-Nr. 3W..9..057 480→, PR-Code 8T1,		0 265 005 777	
				Fg.-Nr. ZA..A..062 464→			
		07.10-05.13	412	PR-Code 8T1		0 265 005 777	
	6.0	03.05-05.13	412			0 265 005 303	



























Continental Flying Spur Speed

	6.0	07.08-05.13	449	PR-Code 8T1		0 265 005 777	



◀ BENTLEY Continental Flying Spur Speed									
	6.0		07.08-05.13	449				0 265 005 303	
Continental GT									
	6.0		06.03-10.10	412			TW	0 265 235 393 ^T	
	4.0 V8, V8 S		01.12→	373/389			PR-Code 8T1	0 265 005 777	
	6.0		06.03-10.10	412			Fg.-Nr. →3W..7..051 362	0 265 005 252	
							Fg.-Nr. 3W..8..050 094→3W..8..057 728, 3W..8..057 737→3W..8..059 917	0 265 005 777	
							Fg.-Nr. 3W..9..059 521→, PR-Code 8T1, Fg.-Nr. ZA..A..062 566→	0 265 005 777	
			11.10→	423			PR-Code 8T1	0 265 005 777	
	6.0		06.03-10.10	412				0 265 005 303	
Continental GT Speed									
	6.0		05.06-07.10	449			TW	0 265 235 393 ^T	
	6.0 FFV								
	6.0		09.12-05.14	460			PR-Code 8T1	0 265 005 777	
	6.0		05.06-07.10	449			Fg.-Nr. →3W..7..051 362	0 265 005 252	
	6.0 FFV						Fg.-Nr. 3W..8..050 094→3W..8..057 728, 3W..8..057 737→3W..8..059 917	0 265 005 777	
							Fg.-Nr. 3W..9..059 521→, PR-Code 8T1, Fg.-Nr. ZA..A..062 566→	0 265 005 777	
	6.0		05.06-07.10	449				0 265 005 303	
	6.0 FFV								
Continental GTC									
	6.0		12.04-04.11	412			TW	0 265 235 393 ^T	
	6.0 FFV								
	6.0		12.04-04.11	412			Fg.-Nr. →3W..7..051 364	0 265 005 252	
	6.0 FFV						Fg.-Nr. 3W..8..051 366→3W..8..057 727, 3W..8..057 732→3W..8..059 516	0 265 005 777	
							Fg.-Nr. 3W..9..059 519→, PR-Code 8T1, Fg.-Nr. ZA..A..062 022→	0 265 005 777	
	6.0		12.04-04.11	412				0 265 005 303	
	6.0 FFV								
Continental GTC Speed									
	6.0		05.09-04.11	449				0 265 235 393 ^T	
	6.0 FFV								
	6.0		05.09-04.11	449			PR-Code 8T1	0 265 005 777	
	6.0 FFV								



		S							
	6.0 6.0 FFV	05.09-04.11	449				0 265 005 303		
Continental Supersport									
									
	6.0	03.10-12.11	463	PR-Code 8T1			0 265 005 777		
	6.0	03.10-12.11	463				0 265 005 303		
Continental Supersports									
									
	6.0	03.10-12.11	463	PR-Code 8T1			0 265 005 777		
	6.0	03.10-12.11	463				0 265 005 303		
Continental Supersports Cabrio									
									
	6.0	03.10-12.11	463	PR-Code 8T1			0 265 005 777		
	6.0	03.10-12.11	463				0 265 005 303		
Continental Supersports ISR Cabrio									
									
	6.0	03.11-12.11	471	PR-Code 8T1			0 265 005 777		
	6.0	03.11-12.11	471				0 265 005 303		
Flying Spur									
									
	6.0 W12	03.13→	460				0 265 005 303		
BMW									
i 8 [I 12]									
									
		06.14→	170				0 204 817 663	26,99	
Serie X [E 53]									
									
	X5 3.0 d	03.01-09.01	135		JBH		0 986 480 976	25,4	
		10.01-09.03	135				0 986 480 849	25,4	
		10.03-10.06	155-160				0 986 480 849	25,4	



BMW Serie X [E 53]								
	X5 3.0i	03.99-09.01	170/210		JBH	0986 480 976	25,4	
	X5 4.4i	10.01-09.06	170/210			0986 480 849	25,4	
	X5 4.4i, 4.6 is, 4.8 is	02.02-10.06	235/255/265			0986 480 849	25,4	
	X5 3.0 d	03.01-09.01	135			0986 486 049	19,05	
		10.01-09.03	135			0986 486 065	19,05	
		10.03-10.06	155-160			0986 486 065	19,05	
	X5 3.0i	10.99-09.01	170			0986 486 049	19,05	
		10.01-09.06	170			0986 486 065	19,05	
	X5 3.0 d, X5 3.0i	10.99-10.06	135/155-160/ 170			0986 486 534	22,2	
	X5 3.0 d	03.01-09.01	135		CS2	0 265 225 010 ^T		
		10.01-09.03	135		CS2	0 265 225 147 ^T		
		10.03-10.06	155-160			0 265 234 096 ^T		
	X5 3.0i	10.99-09.01	170		CS2	0 265 225 010 ^T		
		10.01-10.03	170		CS2	0 265 225 147 ^T		
		11.03-09.06	170			0 265 234 096 ^T		
	X5 4.4i	03.99-09.01	210		CS2	0 265 225 010 ^T		
		10.01-09.03	210		CS2	0 265 225 147 ^T		
		10.03-10.06	235			0 265 234 096 ^T		
	X5 4.6 is	02.02-09.03	255		CS2	0 265 225 147 ^T		
	X5 4.8 is	03.04-10.06	265			0 265 234 096 ^T		
	X5 3.0 d	03.01-09.03	135			0 265 005 248		
		10.03-10.06	155-160			0 265 005 285		
	X5 3.0i	10.99-09.03	170			0 265 005 248		
		10.03-09.06	170			0 265 005 285		
	X5 4.4i	03.99-09.03	210			0 265 005 248		
		10.03-10.06	235			0 265 005 285		
	X5 4.6 is	02.02-09.03	255			0 265 005 248		
	X5 4.8 is	03.04-10.06	265			0 265 005 285		
	X5 3.0 d, 3.0i, 4.4i, 4.6 is	03.99-09.03	135/170/ 210/255			0 265 005 303		
Serie X [E 70]								
	X5 M, M 50 d, 50 i xDrive	09.09-06.13	280/300-330/408			0 265 005 711		
	X5 3.0 d, 30 d xDrive, 30 i xDrive, 3.0 sd, 3.0 si, 35 d xDrive, 35 i xDrive, 40 d xDrive, 4.8 i, 48 i xDrive	11.06-06.13	155-190/ 200/210/ 225/261		EAL EAL	0 265 005 712 0 265 005 711		
Serie X [E 71]								
	X6 M	09.09-06.14	408			0 265 005 711		
	X6 30 d xDrive	04.10-06.14	155-180		EAL EAL	0 265 005 712 0 265 005 711		
	X6 30 d xDrive, 35 d xDrive, 35 i xDrive	03.08-02.09	173/210/225/300			0 265 005 712		
		03.09-06.14	173/210/225/300		EAL	0 265 005 712		
	X6 30 d xDrive, 35 d xDrive, 35 i xDrive, 40 d xDrive, 50 i xDrive	03.09-06.14	173/210/ 225/300		EAL	0 265 005 711		
	X6 40 d xDrive	04.10-06.14	173/210/225/300		EAL	0 265 005 712		
	X6 50 i xDrive	05.08-02.09	173/210/225/300			0 265 005 712		
		03.09-06.14	173/210/225/300		EAL	0 265 005 712		

B

		S							
Serie X [E 72]									
	X6 Active Hybrid	12.09-10.11	357				0 265 005 711		
Serie X [E 83]									
	X3 18 d xDrive, 2.0 d, 20 d xDrive, 2.0i, 20i xDrive, 2.5 si, 2.5i, 25i xDrive, 3.0 d, 30 d xDrive, 3.0 si, 3.0i, 30i xDrive	01.04-08.10	105/110/120-130/ 141/150/155-160/ 170/200				0 986 486 065	19,05	
	X3 18 d xDrive	05.09-08.10	105				0 986 486 607	22,2	
	X3 20 d xDrive	09.08-08.10	120-130				0 986 486 607	22,2	
	X3 20i xDrive	09.08-08.10	110				0 986 486 607	22,2	
	X3 2.0 d	10.04-09.07	110				0 986 486 552	22	
		09.07-03.08	130				0 986 486 552	22	
		04.08-08.08	130				0 986 486 607	22,2	
	X3 2.0i	09.05-03.08	110				0 986 486 552	22	
		04.08-08.08	110				0 986 486 607	22,2	
	X3 2.5 si, 25i xDrive, 3.0 d, 3.0i	04.08-08.10	160				0 986 486 607	22,2	
	X3 2.5 si, 3.0 d, 3.0i	09.05-03.08	160				0 986 486 552	22	
	X3 2.5i, 3.0 d	01.04-08.06	141/150				0 986 486 552	22	
	X3 30 d xDrive	09.08-08.10	155-160				0 986 486 607	22,2	
	X3 30i xDrive	09.08-08.10	200				0 986 486 607	22,2	
	X3 3.0 si	09.06-03.08	200				0 986 486 552	22	
		04.08-08.08	200				0 986 486 607	22,2	
	X3 3.0i	01.04-08.06	170				0 986 486 552	22	
	X3 18 d xDrive	05.09-08.10	105				0 265 236 013 ^T		
	X3 2.0 d, 20 d xDrive	09.07-08.10	120-130				0 265 236 013 ^T		
	X3 2.0 d, 2.0i	10.04-09.06	110				0 265 234 036 ^T		
	X3 2.0 d, 2.0i, 20i xDrive	10.06-08.10	110				0 265 236 013 ^T		
	X3 2.5 si, 25i xDrive	09.06-08.10	160				0 265 236 013 ^T		
	X3 2.5i, 3.0 d	01.04-08.06	141/150				0 265 234 036 ^T		
	X3 30 d xDrive	09.08-08.10	155-160				0 265 236 013 ^T		
	X3 3.0 d	09.05-09.06	160				0 265 234 036 ^T		
		10.06-08.08	160				0 265 236 013 ^T		
	X3 3.0 sd, 3.0 si, 30i xDrive, 35 d xDrive	09.06-08.10	200/210				0 265 236 013 ^T		
	X3 3.0i	01.04-08.06	170				0 265 234 036 ^T		
		09.06-08.08	160				0 265 236 013 ^T		
	X3 18 d xDrive	05.09-08.10	105				0 265 005 713		
	X3 2.0 d, 20 d xDrive	09.07-08.10	120-130				0 265 005 713		
	X3 2.0 d, 2.0i	10.04-09.06	110				0 265 005 285		
	X3 2.0 d, 2.0i, 20i xDrive	10.06-08.10	110				0 265 005 713		
	X3 2.5 si, 25i xDrive	09.06-08.10	160				0 265 005 713		
	X3 2.5i, 3.0 d	01.04-08.06	141/150				0 265 005 285		
	X3 30 d xDrive	09.08-08.10	155-160				0 265 005 713		
	X3 3.0 d	09.05-09.06	160				0 265 005 285		
		10.06-08.08	160				0 265 005 713		
	X3 3.0 sd, 3.0 si, 30i xDrive, 35 d xDrive	09.06-08.10	200/210				0 265 005 713		
	X3 3.0i	01.04-08.06	170				0 265 005 285		
		09.06-08.08	160				0 265 005 713		



		S							
◀ BMW									
Serie X [E 84]									
	X1 16 d sDrive, 16 i sDrive, 18 d sDrive, 18 d xDrive, 18i sDrive, 20 d ed sDrive, 20 d sDrive, 20 d xDrive, 20 s xDrive, 20i sDrive, 20i xDrive, 23 d xDrive, 25 d xDrive, 25i xDrive, 28i xDrive	10.09→	85/100-110/ 120-130/ 135/150/ 160/180/ 190				0986 486 065	19,05	
	X1 16 d sDrive, 16 i sDrive, 18 d sDrive, 18 d xDrive, 18i sDrive, 20 d ed sDrive, 20 d sDrive, 20 d xDrive, 20 s xDrive, 20i sDrive, 20i xDrive, 23 d xDrive, 25 d xDrive, 25i xDrive, 28i xDrive	10.09→	85/100-110/ 120-130/ 135/150/ 160/180/ 190				0986 486 607	22,2	
	X1 16 d sDrive, 16 i sDrive, 18 d sDrive, 18 d xDrive, 18i sDrive, 20 d ed sDrive, 20 d sDrive, 20 d xDrive, 20 s xDrive, 20i sDrive, 20i xDrive, 23 d xDrive, 25 d xDrive, 25i xDrive, 28i xDrive	10.09→	85/100-110/ 120-130/ 135/150/ 160/180/ 190				0265 005 713		
Serie X [F 25]									
	X3 18d sDrive, 20d xDrive, 20i xDrive	10.10→	105/110/ 135/140				0986 486 607	22,2	
Serie X [F 26]									
	X4 xDrive 20 d	06.14→	140				0986 486 607	22,2	
Serie Z Coupé [E 36/8]									
	Z3 M3.2	09.97-12.00	236		JBH	GIR	0986 480 603	20,6	
	Z3 2.8, 3.0i	OFD 09.97-06.02	142/170		JBH	ATE	0986 480 931	23,81	
	Z3 M3.2, 2.8, 3.0i	09.97-06.02	142/170/ 236/239				0986 486 040	19,05	
	Z3 M3.2, 3.0i	09.97-06.02	170/236/239				0986 486 534	22,2	
	Z3 2.8	09.97-01.99	142				0986 486 533	20,64	
		02.99-09.00	142				0986 486 534	22,2	
Serie Z Coupé [E 86]									
	Z4 3.0 si	04.07-08.08	195		JBH		0986 481 017	23,8	
	Z4 M3.2 Z4 3.0 si	03.06-08.08	195/252				0986 486 065	19,05	
	Z4 M3.2 Z4 3.0 si	03.06-08.08	195/252				0986 486 552	22	

B



Serie Z [E 36/7]

	Z 3 M 3.2	11.96-12.00	236		JBH	GIR	0 986 480 603	20,6
	Z 3 1.8, 1.9	03.95-09.02	85/87/103		JBH	ATE	0 986 480 931	23,81
	Z 3 2.0, 2.2i, 2.5, 2.8, 3.0i	OFD 11.96-09.02	110/125/142/170		JBH	ATE	0 986 480 931	23,81
	Z 3 M 3.2	11.96-05.97	236				0 986 486 034	19,05
		06.97-12.00	236				0 986 486 040	19,05
		02.01-09.02	239				0 986 486 040	19,05
	Z 3 1.8	03.95-05.97	85				0 986 486 034	19,05
		06.97-12.98	85				0 986 486 040	19,05
	Z 3 1.9	09.95-05.97	103				0 986 486 034	19,05
		06.97-12.99	103				0 986 486 040	19,05
		09.98-09.02	87				0 986 486 040	19,05
	Z 3 2.0, 2.2i, 2.5	09.98-09.02	110/125				0 986 486 040	19,05
	Z 3 2.8	11.96-05.97	142				0 986 486 034	19,05
		06.97-08.00	142				0 986 486 040	19,05
	Z 3 3.0i	05.00-06.02	170				0 986 486 040	19,05
	Z 3 M 3.2, 3.0i	11.96-09.02	170/236/239				0 986 486 534	22,2
	Z 3 1.8	03.95-12.98	85				0 986 486 533	20,64
	Z 3 1.9	09.95-12.99	103				0 986 486 533	20,64
		09.98-09.02	87				0 986 486 534	22,2
	Z 3 2.0, 2.2i, 2.5	09.98-09.02	110/125				0 986 486 534	22,2
	Z 3 2.8	11.96-01.99	142				0 986 486 533	20,64
		02.99-08.00	142				0 986 486 534	22,2

Serie Z [E 52]

	Z 8	03.00-07.03	294				0 986 486 049	19,05
	Z 8	03.00-07.03	294				0 986 486 534	22,2
	Z 8	03.00-07.03	294		GRG		0 265 225 006 ^T	
	Z 8	03.00-07.03	294				0 265 005 248	
	Z 8	03.00-07.03	294				0 265 005 303	

Serie Z [E 85]

	Z 4 2.0i, 2.5i	04.07-08.08	110/130		JBH		0 986 481 017	23,8
	Z 4 2.5 si	04.07-08.08	160		JBH		0 986 481 017	23,8
	Z 4 2.5i	10.02-11.05	141		JBH		0 986 481 017	23,8
	Z 4 3.0 si	04.07-08.08	195		JBH		0 986 481 017	23,8
	Z 4 3.0i	10.02-11.05	170		JBH		0 986 481 017	23,8
	Z 4 M 3.2, 2.0i, 2.2i, 2.5 si, 2.5i, 3.0 si, 3.0i	10.02-08.08	110/125/130/141/160/170/195/252				0 986 486 065	19,05
	Z 4 M 3.2, 2.0i, 2.2i, 2.5 si, 2.5i, 3.0 si, 3.0i	10.02-08.08	110/125/130/141/160/170/195/252				0 986 486 552	22



		S							
◀ BMW									
Serie Z [E 89]									
	Z 4 18i sDrive, 20i sDrive, 23i sDrive, 28i sDrive, 30i sDrive, 35i sDrive, 35is sDrive	04.09→	115/135/150/ 180/190/ 225/250				0986 486 065		19,05
	Z 4 18i sDrive, 20i sDrive, 23i sDrive, 28i sDrive, 30i sDrive, 35i sDrive, 35is sDrive	04.09→	115/135/150/ 180/190/ 225/250				0986 486 607		22,2
	Z 4 18i sDrive, 20i sDrive, 23i sDrive, 28i sDrive, 30i sDrive, 35i sDrive, 35is sDrive	04.09→	115/135/150/ 180/190/ 225/250				0265 005 713		
Serie 1 Cabrio [E 88]									
	118 d, i	03.08-10.13	100-105				0986 486 065		19,05
	120 d, i	03.08-10.13	115/120-130				0986 486 065		19,05
	123 d	09.08-09.13	150				0986 486 065		19,05
	125 i	03.08-10.13	160				0986 486 065		19,05
	135 i	03.08-10.13	225-240				0986 486 065		19,05
	118 d, i	03.08-10.13	100-105				0986 486 607		22,2
	120 d, i	03.08-10.13	115/120-130				0986 486 607		22,2
	123 d	09.08-09.13	150				0986 486 607		22,2
	125 i	03.08-10.13	160				0986 486 607		22,2
	135 i	03.08-10.13	225-240				0986 486 607		22,2
Serie 1 Coupé [E 82]									
	M	04.11-06.12	250				0986 486 065		19,05
	118 d	09.09-10.13	100-105				0986 486 065		19,05
	120 d, i	10.07-10.13	115/120-130				0986 486 065		19,05
	123 d	10.07-09.13	150				0986 486 065		19,05
	125 i	03.08-09.13	160				0986 486 065		19,05
	135 i	10.07-10.13	225-240				0986 486 065		19,05
	M	04.11-06.12	250				0986 486 607		22,2
	118 d	09.09-10.13	100-105				0986 486 607		22,2
	120 d, i	10.07-10.13	115/120-130				0986 486 607		22,2
	123 d	10.07-09.13	150				0986 486 607		22,2
	125 i	03.08-09.13	160				0986 486 607		22,2
	135 i	10.07-10.13	225-240				0986 486 607		22,2
Serie 1 [E 81]									
	116 d, i	09.07-12.11	66-85/90				0986 486 065		19,05
	118 d, i	05.07-12.11	100-105				0986 486 065		19,05
	120 d, i	05.07-12.11	115/120-130				0986 486 065		19,05
	123 d	09.07-12.11	150				0986 486 065		19,05
	130 i	05.07-12.11	190/195				0986 486 065		19,05
	116 d, i	09.07-12.11	66-85/90				0986 486 607		22,2
	118 d, i	05.07-12.11	100-105				0986 486 607		22,2
	120 d, i	05.07-12.11	115/120-130				0986 486 607		22,2
	123 d	09.07-12.11	150				0986 486 607		22,2
	130 i	05.07-12.11	190/195				0986 486 607		22,2





Serie 1 [E 87]

	116 d, i	09.04-06.11	66-85/90	0 986 486 065	19,05
	118 d, i	09.04-06.11	90/95/100-105	0 986 486 065	19,05
	120 d, i	09.04-06.11	110/115/120-130	0 986 486 065	19,05
	123 d	09.07-06.11	150	0 986 486 065	19,05
	130 i	09.05-06.11	190/195	0 986 486 065	19,05
	116 d	03.09-06.11	66-85	0 986 486 607	22,2
	116 i	09.04-10.06	85	0 986 486 534	22,2
		11.06-06.11	85	0 986 486 607	22,2
		09.07-06.11	90	0 986 486 607	22,2
	118 d	09.04-10.06	90/95	0 986 486 534	22,2
	118 i	11.06-03.07	90/95	0 986 486 607	22,2
		03.07-06.11	100-105	0 986 486 607	22,2
	120 d	09.04-10.06	120	0 986 486 534	22,2
		11.06-03.07	120	0 986 486 607	22,2
	120 d, i	03.07-06.11	120-130	0 986 486 607	22,2
	120 i	09.04-10.06	110	0 986 486 534	22,2
		11.06-03.07	110	0 986 486 607	22,2
		03.07-06.11	115	0 986 486 607	22,2
	123 d	09.07-06.11	150	0 986 486 607	22,2
	130 i	09.05-10.06	195	0 986 486 534	22,2
		11.06-08.09	195	0 986 486 607	22,2
		09.09-06.11	190	0 986 486 607	22,2

Serie 1 [F 20]

	M 135 i	07.12-02.15	235	LLE	0 204 781 585	25,4
				RLE	0 204 781 589	25,4
	M 135 i	03.15→	240	LLE	0 204 781 585	25,4
				RLE	0 204 781 589	25,4
	M 135 i xDrive	11.12-02.15	235	LLE	0 204 781 585	25,4
				RLE	0 204 781 589	25,4
	114 d	07.12→	70/75	LLE, SBJ	0 204 781 585	25,4
				LLE, SBJ	0 204 776 585	23,81
				RLE, SBJ	0 204 781 589	25,4
	116 d	09.11→	85	LLE, SBJ	0 204 781 585	25,4
				LLE, SBJ	0 204 776 585	23,81
				RLE, SBJ	0 204 781 589	25,4
	116 d ed	03.12-02.15	85	LLE, SSJ	0 204 781 585	25,4
				LLE, SSJ	0 204 776 585	23,81
				RLE, SSJ	0 204 781 589	25,4
	116 i	03.15→	85	LLE	0 204 776 585	23,81
				LLE, SSJ	0 204 781 585	25,4
				LLE, SSJ	0 204 776 585	23,81
	116 i	09.11-02.15	100	LLE, SSJ	0 204 781 585	25,4
				LLE, SSJ	0 204 776 585	23,81
				RLE, SSJ	0 204 781 589	25,4
	116 i	03.15→	80	LLE, SBJ	0 204 781 585	25,4
				LLE, SBJ	0 204 776 585	23,81
				RLE, SBJ	0 204 781 589	25,4
	118 d	09.11→	105/110	LLE, SBJ	0 204 781 585	25,4
				LLE, SBJ	0 204 776 585	23,81
				RLE, SBJ	0 204 781 589	25,4
	118 d xDrive	07.13→	105/110	SBJ	0 204 781 585	25,4
				SBJ	0 204 776 585	23,81
	118 i	09.11-02.15	125	LLE, SSJ	0 204 781 585	25,4
				LLE, SSJ	0 204 776 585	23,81
				RLE, SSJ	0 204 781 589	25,4
				LLE, SBJ	0 204 781 585	25,4
	118 i	03.15→	100	LLE, SBJ	0 204 776 585	23,81
				RLE, SBJ	0 204 781 589	25,4

























	BMW Serie 1 [F 20]						
	120 d, d xDrive, i, xDrive	09.11→	130/135-147	LLE, SBJ	0 204 781 585	25,4	
				LLE, SBJ	0 204 776 585	23,81	
				RLE, SBJ	0 204 781 589	25,4	
	125 d, i	03.12→	160/165	LLE	0 204 781 585	25,4	
				RLE	0 204 781 589	25,4	
	M 135 i	07.12→	235/240		0 986 486 065	19,05	
	114 d, i	07.12→	70/75		0 986 486 065	19,05	
	116 d, d ed, i	09.11→	80/85/100		0 986 486 065	19,05	
	118 d, d xDrive, i	09.11→	100/105/110/125		0 986 486 065	19,05	
	120 d, d xDrive, i, xDrive	09.11→	130/135-147		0 986 486 065	19,05	
	125 d, i	03.12→	160/165		0 986 486 065	19,05	

Serie 1 [F 21]

	M 135 i	09.12-02.15	235	LLE	0 204 781 585	25,4	
				RLE	0 204 781 589	25,4	
		03.15→	240		0 204 781 585	25,4	
				LLE	0 204 781 585	25,4	
				RLE	0 204 781 589	25,4	
	M 135 i xDrive	11.12-02.15	235		0 204 781 585	25,4	
	114 d	09.12→	70/75	LLE, SBJ	0 204 781 585	25,4	
	114 i			LLE, SBJ	0 204 776 585	23,81	
				RLE, SBJ	0 204 781 589	25,4	
	116 d	09.12→	85	LLE, SBJ	0 204 776 585	23,81	
	116 d ed	09.12-02.15	85	LLE, SBJ	0 204 776 585	23,81	
		03.15→	85	LLE	0 204 776 585	23,81	
	116 d	09.12→	85	LLE, SBJ	0 204 781 585	25,4	
	116 d ed			RLE, SBJ	0 204 781 589	25,4	
	116 i	09.12-02.15	100	LLE, SBJ	0 204 781 585	25,4	
				LLE, SBJ	0 204 776 585	23,81	
				RLE, SBJ	0 204 781 589	25,4	
		03.15→	80	LLE, SBJ	0 204 781 585	25,4	
				LLE, SBJ	0 204 776 585	23,81	
				RLE, SBJ	0 204 781 589	25,4	
	118 d	09.12→	105/110	LLE, SBJ	0 204 781 585	25,4	
				LLE, SBJ	0 204 776 585	23,81	
				RLE, SBJ	0 204 781 589	25,4	
		03.15→	105/110	SBJ	0 204 781 585	25,4	
				SBJ	0 204 776 585	23,81	
	118 d xDrive	07.13-02.15	105/110	SBJ	0 204 781 585	25,4	
				SBJ	0 204 776 585	23,81	
	118 i	11.12-02.15	125	LLE, SBJ	0 204 781 585	25,4	
				LLE, SBJ	0 204 776 585	23,81	
				RLE, SBJ	0 204 781 589	25,4	
		03.15→	100	LLE, SBJ	0 204 781 585	25,4	
				LLE, SBJ	0 204 776 585	23,81	
				RLE, SBJ	0 204 781 589	25,4	
	120 d	11.12→	135-147	LLE, SBJ	0 204 781 585	25,4	
				LLE, SBJ	0 204 776 585	23,81	
				RLE, SBJ	0 204 781 589	25,4	
	120 d xDrive	11.12→	135-147	SBJ	0 204 781 585	25,4	
				SBJ	0 204 776 585	23,81	
	120 i	03.15→	130	LLE, SBJ	0 204 781 585	25,4	
				LLE, SBJ	0 204 776 585	23,81	
				RLE, SBJ	0 204 781 589	25,4	
	125 d	09.12→	160/165	LLE	0 204 781 585	25,4	
	125 i			RLE	0 204 781 589	25,4	

	M 135 i	09.12→	235/240		0 986 486 065	19,05	
	114 d, i	09.12→	70/75		0 986 486 065	19,05	















									
116 d, d ed, i		09.12→	80/85/100				0 986 486 065	19,05	
118 d, d xDrive, i		09.12→	100/105/110/125				0 986 486 065	19,05	
120 d, d xDrive, i		11.12→	130/135-147				0 986 486 065	19,05	
125 d, i		09.12→	160/165				0 986 486 065	19,05	
Serie 1 [F20]									
									
	118 i	07.15→	100			LLE, SBJ	0 204 781 585	25,4	
						LLE, SBJ	0 204 776 585	23,81	
						RLE, SBJ	0 204 781 589	25,4	
	118 i	07.15→	100				0 986 486 065	19,05	
Serie 2 Active Tourer [F 45]									
									
	214 d	03.15→	70				0 204 817 536	22,2	
	216 d	11.14→	85				0 204 817 536	22,2	
	218 d, i	09.14→	100/110				0 204 817 536	22,2	
	220 d, d xDrive, i	11.14→	140/141				0 204 817 536	22,2	
	225 i, i xDrive	09.14→	170				0 204 820 542	23,81	
	214 d	03.15→	70				0 204 828 465		
	216 d	03.15→	85				0 204 828 465		
	218 d, i	03.15→	100/110				0 204 828 465		
	220 d, d xDrive, i	03.15→	140/141				0 204 828 465		
	225 i, i xDrive	03.15→	170				0 204 828 465		
Serie 2 Cabrio [F 23]									
									
	M 235 i	11.14→	240			LLE	0 204 781 585	25,4	
						RLE	0 204 781 589	25,4	
		07.15→	240				0 204 781 585	25,4	
	218 d	03.15→	100/110			LLE, SBJ	0 204 781 585	25,4	
	218 i					LLE, SBJ	0 204 776 585	23,81	
						RLE, SBJ	0 204 781 589	25,4	
	220 d	11.14→	140			LLE	0 204 781 585	25,4	
						RLE	0 204 781 589	25,4	
	220 i	11.14→	135			LLE, SBJ	0 204 781 585	25,4	
						LLE, SBJ	0 204 776 585	23,81	
						RLE, SBJ	0 204 781 589	25,4	
	225 d	07.15→	165			LLE	0 204 781 585	25,4	
						RLE	0 204 781 589	25,4	
	228 i	11.14→	180			LLE	0 204 781 585	25,4	
						RLE	0 204 781 589	25,4	
	M 235 i	11.14→	240				0 986 486 065	19,05	
	218 d, i	03.15→	100/110				0 986 486 065	19,05	
	220 d, i	11.14→	135/140				0 986 486 065	19,05	
	228 i	11.14→	180				0 986 486 065	19,05	
Serie 2 Coupé [F 22]									
									
	M 235 i	03.14→	240			LLE	0 204 781 585	25,4	
						RLE	0 204 781 589	25,4	
	M 235 i xDrive	06.14→	240				0 204 781 585	25,4	



		S							
BMW Serie 2 Coupé [F 22]									
218 d		03.14→	100/105/			LLE, SBJ	0 204 781 585	25,4	
218 i			110			LLE, SBJ	0 204 776 585	23,81	
						RLE, SBJ	0 204 781 589	25,4	
220 d		11.14→	140			LLE	0 204 781 585	25,4	
220 d xDrive						RLE	0 204 781 589	25,4	
220 d		03.14→	135			LLE, SBJ	0 204 781 585	25,4	
220 i						LLE, SBJ	0 204 776 585	23,81	
						RLE, SBJ	0 204 781 589	25,4	
225 d		03.14→	160/165			LLE	0 204 781 585	25,4	
						RLE	0 204 781 589	25,4	
228 i		06.14→	180			LLE	0 204 781 585	25,4	
						RLE	0 204 781 589	25,4	
M 235 i									
M 235 i		03.14→	240				0 986 486 065	19,05	
218 d, i		03.14→	100/105/110				0 986 486 065	19,05	
220 d, i		03.14→	135/140				0 986 486 065	19,05	
225 d		03.14→	160				0 986 486 065	19,05	
228 i		06.14→	180				0 986 486 065	19,05	
Serie 2 Grand Tourer [F 46]									
214 d									
214 d		07.15→	70				0 204 820 542	23,81	
215 d									
215 d		06.15→	85				0 204 820 542	23,81	
216 i									
216 i		07.15→	75				0 204 820 542	23,81	
218 d, i									
218 d, i		06.15→	100/110				0 204 820 542	23,81	
220 d, d xDrive, i									
220 d, d xDrive, i		06.15→	140/141				0 204 820 542	23,81	
214 d									
214 d		07.15→	70				0 204 828 467		
215 d									
215 d		06.15→	85				0 204 828 467		
218 d, i									
218 d, i		06.15→	100/110				0 204 828 467		
220 d, d xDrive, i									
220 d, d xDrive, i		06.15→	140/141				0 204 828 397		
Serie 3 Cabrio [E 36]									
M 3									
M 3		01.94-12.95	210			JBH	0 986 480 950	25,4	
M 3 3.2									
M 3 3.2		01.96-12.99	236			JBH GIR	0 986 480 603	20,6	
318 i									
318 i		01.94-09.94	85			JBH ATE	0 986 480 640	23,8	
		10.94-12.99	85			JBH ATE	0 986 480 931	23,81	
320 i									
320 i		03.93-09.94	110			JBH ATE	0 986 480 640	23,8	
		09.94-09.94	110			JBH,TKO ATE	0 986 480 640	23,8	
		09.94-09.96	110			JBH,TKO ATE	0 986 480 640	23,8	
		10.94-12.95	110			JBH ATE	0 986 480 931	23,81	
		10.94-12.99	110			JBH,TKO ATE	0 986 480 931	23,81	
		10.96-12.99	110			JBH,TKO ATE	0 986 480 931	23,81	
323 i									
323 i		05.95-09.96	125			JBH,TKO ATE	0 986 480 640	23,8	
		05.95-09.99	125			JBH,TKO ATE	0 986 480 931	23,81	
		10.96-09.99	125			JBH,TKO ATE	0 986 480 931	23,81	
325 i									
325 i		03.93-09.94	141			JBH,TKO ATE	0 986 480 640	23,8	
		03.93-12.95	141			JBH,TKO ATE	0 986 480 640	23,8	
		10.94-12.95	141			JBH,TKO ATE	0 986 480 931	23,81	
328 i									
328 i		03.95-09.96	142			JBH,TKO ATE	0 986 480 640	23,8	
		03.95-09.99	142			JBH,TKO ATE	0 986 480 931	23,81	
		10.96-09.99	142			JBH,TKO ATE	0 986 480 931	23,81	
M 3									
M 3		01.94-10.94	210			RGR	0 986 486 017	19	
		11.94-12.95	210			RGS	0 986 486 034	19,05	
M 3 3.2									
M 3 3.2		01.96-05.97	236			RGS	0 986 486 034	19,05	
		06.97-12.99	236				0 986 486 040	19,05	



		S							
318i		01.94-10.94	85			RGR	0 986 486 017	19	
		11.94-05.97	85			RGS	0 986 486 034	19,05	
		06.97-12.99	85				0 986 486 040	19,05	
320i		03.93-10.94	110			RGR	0 986 486 017	19	
		11.94-05.97	110			RGS	0 986 486 034	19,05	
		06.97-12.99	110				0 986 486 040	19,05	
323i		05.95-05.97	125			RGS	0 986 486 034	19,05	
		06.97-09.99	125				0 986 486 040	19,05	
325i		03.93-10.94	141				0 986 486 017	19	
		11.94-12.95	141				0 986 486 034	19,05	
328i		03.95-05.97	142			RGS	0 986 486 034	19,05	
		06.97-09.99	142				0 986 486 040	19,05	
	M 3, 3.2	01.94-12.99	210/236				0 986 486 534	22,2	
	318i	01.94-12.99	85				0 986 486 533	20,64	
	320i	03.93-12.99	110				0 986 486 533	20,64	
	323i	05.95-09.99	125				0 986 486 533	20,64	
	325i	03.93-12.95	141				0 986 486 533	20,64	
	328i	03.95-09.99	142				0 986 486 533	20,64	
Serie 3 Cabrio [E 46]									
									
	318i	04.04-08.06	105-110			JBH	0 986 481 017	23,8	
		MFD 09.01-03.04	105			JBH	0 986 481 017	23,8	
		OFD 09.01-03.04	105			JBH	0 986 480 868	23,8	
	320d	OFD 01.05-08.06	110			JBH	0 986 480 868	23,8	
	320d,i	MFD 10.01-08.06	110/120-125			JBH	0 986 481 017	23,8	
	320i	OFD 09.00-09.01	120-125			JBH	0 986 480 877	22	
		10.01-08.06	120-125			JBH	0 986 480 868	23,8	
	323i	MFD 03.00-09.00	125			JBH	0 986 481 010		
		OFD 03.00-09.00	125			JBH	0 986 480 877	22	
	325i	MFD 10.01-08.06	141			JBH	0 986 481 017	23,8	
		OFD 09.00-09.01	141			JBH	0 986 480 877	22	
		10.01-08.06	141			JBH	0 986 480 868	23,8	
	330d	04.05-08.06	150			JBH	0 986 481 017	23,8	
	330i	MFD 05.00-09.00	170			JBH	0 986 481 011		
		10.00-08.06	170			JBH	0 986 481 017	23,8	
		OFD 05.00-09.01	170			JBH	0 986 480 882	23,8	
		10.01-08.06	170			JBH	0 986 480 868	23,8	
	M 3	04.01-08.06	252				0 986 486 065	19,05	
	318i	09.01-08.06	105-110				0 986 486 065	19,05	
	320d	01.05-08.06	110				0 986 486 065	19,05	
	320i	09.00-03.01	120-125				0 986 486 049	19,05	
		04.01-08.06	120-125				0 986 486 065	19,05	
	323i	03.00-09.00	125				0 986 486 049	19,05	
	325i	09.00-03.01	141				0 986 486 049	19,05	
		04.01-08.06	141				0 986 486 065	19,05	
	330d	04.05-08.06	150				0 986 486 065	19,05	
	330i	05.00-03.01	170				0 986 486 049	19,05	
		04.01-08.06	170				0 986 486 065	19,05	
	M 3	04.01-08.06	252			SSG	0 986 486 552	22	
	318i	09.01-08.06	105-110				0 986 486 552	22	
	320d,i	09.00-08.06	110/120-125				0 986 486 552	22	
	323i	03.00-09.00	125				0 986 486 552	22	
	325i	09.00-08.06	141				0 986 486 552	22	
	330d,i	05.00-08.06	150/170				0 986 486 552	22	



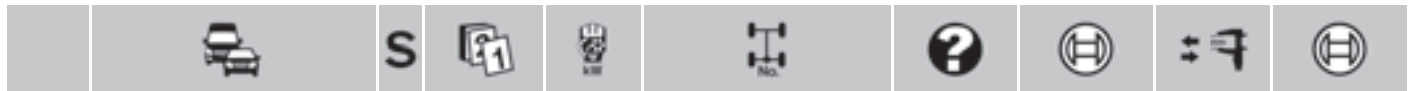

◀ BMW

Serie 3 Cabrio [E 93]



	M 3	03.08-10.13	309			0986 486 065	19,05
	318 i	03.10-09.13	105			0986 486 065	19,05
	320 d, i	03.07-10.13	115/120-135			0986 486 065	19,05
	323 i	09.07-04.12	130			0986 486 065	19,05
	325 d, i	03.07-09.13	145/150/155-160			0986 486 065	19,05
	328 i	09.06-07.13	170-172			0986 486 065	19,05
	330 d, i	03.07-09.13	170/180/190-200			0986 486 065	19,05
	335 i	03.07-10.13	225-240			0986 486 065	19,05

	M 3	03.08-10.13	309			0986 486 607	22,2
	318 i	03.10-09.13	105			0986 486 607	22,2
	320 d, i	03.07-10.13	115/120-135			0986 486 607	22,2
	323 i	09.07-04.12	130			0986 486 607	22,2
	325 d, i	03.07-09.13	145/150/155-160			0986 486 607	22,2
	328 i	09.06-10.06	170-172			0986 486 534	22,2
		11.06-07.13	170-172			0986 486 607	22,2
	330 d, i	03.07-09.13	170/180/190-200			0986 486 607	22,2
	335 i	03.07-10.13	225-240			0986 486 607	22,2

Serie 3 Compact [E 36]



	316 g	09.95-09.00	64-75		JBH ATE	0986 480 931	23,81
	316 i	03.94-09.94	75		JBH ATE	0986 480 640	23,8
		03.94-09.00	75		JBH GIR	0986 480 600	23,81
		10.94-09.00	75		JBH ATE	0986 480 931	23,81
		12.98-09.00	77		JBH ATE	0986 480 931	23,81
	318 tds, ti	09.94-09.00	66/103		JBH ATE	0986 480 931	23,81
323 ti	06.97-09.00	125		JBH ATE	0986 480 931	23,81	

	316 i	03.94-09.00	75		LLE GIR	0986 485 122	
--	--------------	-------------	----	--	---------	---------------------	--













	316 g	09.95-05.97	64-75		RGS	0986 486 034	19,05
		06.97-09.00	64-75			0986 486 040	19,05
	316 i	03.94-10.94	75			0986 486 017	19
		11.94-05.97	75			0986 486 034	19,05
		06.97-09.00	75			0986 486 040	19,05
		12.98-09.00	77			0986 486 040	19,05
	318 tds	01.95-05.97	66		RGS	0986 486 034	19,05
		06.97-09.00	66			0986 486 040	19,05
	318 ti	09.94-10.94	103		RGR	0986 486 017	19
		11.94-05.97	103		RGS	0986 486 034	19,05
		06.97-09.00	103			0986 486 040	19,05
	323 ti	06.97-09.00	125			0986 486 040	19,05

	316 g, i	03.94-09.00	64-75			0986 486 533	20,64
	316 i	12.98-09.00	77			0986 486 534	22,2
	318 tds, ti	09.94-09.00	66/103			0986 486 533	20,64
	323 ti	06.97-01.99	125			0986 486 533	20,64
		02.99-09.00	125			0986 486 534	22,2

Serie 3 Compact [E 46]



	316 ti	04.04-12.04	85		JBH	0986 481 017	23,8	
		MFD	10.01-03.04	85		JBH	0986 481 017	23,8
		OFD	06.01-09.01	85		JBH	0986 480 877	22
			10.01-03.04	85		JBH	0986 480 868	23,8

		S							
									
318td		03.03-12.04	85			JBH	0 986 481 017	23,8	
318ti		04.04-12.04	105			JBH	0 986 481 017	23,8	
		MFD 09.01-03.04	105			JBH	0 986 481 017	23,8	
		OFD 09.01-03.04	105			JBH	0 986 480 868	23,8	
320td		MFD 09.01-12.04	110			JBH	0 986 481 017	23,8	
		OFD 09.01-12.04	110			JBH	0 986 480 868	23,8	
325ti		MFD 10.01-12.04	141			JBH	0 986 481 017	23,8	
		OFD 06.01-09.01	141			JBH	0 986 480 877	22	
		10.01-12.04	141			JBH	0 986 480 868	23,8	
									
316ti		06.01-12.04	85				0 986 486 065	19,05	
318td, ti		09.01-12.04	85/105				0 986 486 065	19,05	
320td		09.01-12.04	110				0 986 486 065	19,05	
325ti		06.01-12.04	141				0 986 486 065	19,05	
									
									
M 3		09.92-12.96	179/210-217			JBH	0 986 480 950	25,4	
M 3 3.2		10.95-12.98	236			JBH GIR	0 986 480 603	20,6	
316i		09.93-09.94	75			JBH ATE	0 986 480 640	23,8	
		10.94-12.99	75			JBH ATE	0 986 480 931	23,81	
318is		03.92-09.94	103			JBH ATE	0 986 480 640	23,8	
		10.94-08.99	103			JBH ATE	0 986 480 931	23,81	
320i		03.92-09.94	110			JBH ATE	0 986 480 640	23,8	
		09.94-09.96	110			JBH,TKO ATE	0 986 480 640	23,8	
		09.94-12.98	110			JBH,TKO ATE	0 986 480 931	23,81	
		10.94-12.95	110			JBH ATE	0 986 480 931	23,81	
		10.96-12.98	110			JBH,TKO ATE	0 986 480 931	23,81	
323i		03.95-09.96	125			JBH,TKO ATE	0 986 480 640	23,8	
		03.95-06.99	125			JBH,TKO ATE	0 986 480 931	23,81	
		10.96-06.99	125			JBH,TKO ATE	0 986 480 931	23,81	
325i		03.91-09.94	141			JBH,TKO ATE	0 986 480 640	23,8	
325is		03.91-12.95	141			JBH,TKO ATE	0 986 480 640	23,8	
		10.94-12.95	141			JBH,TKO ATE	0 986 480 931	23,81	
328i		03.95-09.96	142			JBH,TKO ATE	0 986 480 640	23,8	
		03.95-06.99	142			JBH,TKO ATE	0 986 480 931	23,81	
		10.96-06.99	142			JBH,TKO ATE	0 986 480 931	23,81	
									
M 3		09.92-10.94	210-217			RGR	0 986 486 017	19	
		09.93-12.96	179				0 986 486 034	19,05	
		11.94-09.95	210-217			RGS	0 986 486 034	19,05	
M 3 3.2		10.95-05.97	236			RGS	0 986 486 034	19,05	
		06.97-12.98	236				0 986 486 040	19,05	
316i		09.93-10.94	75			RGR	0 986 486 017	19	
		11.94-05.97	75			RGS	0 986 486 034	19,05	
		06.97-12.99	75				0 986 486 040	19,05	
318is		03.92-10.94	103				0 986 486 017	19	
		11.94-09.96	103				0 986 486 034	19,05	
		12.95-05.97	103			RGS	0 986 486 034	19,05	
		06.97-08.99	103				0 986 486 040	19,05	
320i		03.92-10.94	110			RGR	0 986 486 017	19	
		11.94-05.97	110			RGS	0 986 486 034	19,05	
		06.97-12.98	110				0 986 486 040	19,05	
323i		03.95-05.97	125			RGS	0 986 486 034	19,05	
		06.97-06.99	125				0 986 486 040	19,05	





BMW Serie 3 Coupé [E 36]













325 i	03.92-10.94	141		0986 486 017	19
	11.94-12.95	141		0986 486 034	19,05
325 is	03.91-10.94	141	RGR	0986 486 017	19
	11.94-09.95	141	RGS	0986 486 034	19,05
328 i	03.95-05.97	142		0986 486 034	19,05
	06.97-06.99	142		0986 486 040	19,05

M 3, 3.2	09.92-12.98	179/210-217/236		0986 486 534	22,2
	09.93-12.99	75		0986 486 533	20,64
318 is	03.92-08.99	103		0986 486 533	20,64
320 i	03.92-12.98	110		0986 486 533	20,64
323 i	03.95-06.99	125		0986 486 533	20,64
325 i, is	03.91-12.95	141		0986 486 533	20,64
328 i	03.95-01.99	142		0986 486 533	20,64
	02.99-06.99	142		0986 486 534	22,2

Serie 3 Coupé [E 46]

316 i	04.04-05.06	85	JBH	0986 481 017	23,8
	MFD 10.99-09.00	75	JBH	0986 481 010	
	10.01-09.02	75	JBH	0986 481 017	23,8
	03.02-03.04	85	JBH	0986 481 017	23,8
	OFD 10.99-09.01	75	JBH	0986 480 877	22
318 i	04.04-05.06	105-110	JBH	0986 481 017	23,8
	MFD 04.99-09.00	87	JBH	0986 481 010	
	02.01-09.01	87	JBH	0986 481 017	23,8
	09.01-03.04	105	JBH	0986 481 017	23,8
	OFD 04.99-09.01	87	JBH	0986 480 877	22
320 d	09.03-05.06	110	JBH	0986 481 017	23,8
	OFD 09.03-05.06	110/120-125	JBH	0986 480 868	23,8
	MFD 04.98-09.00	110	JBH	0986 481 010	
	10.01-05.06	120-125	JBH	0986 481 017	23,8
	OFD 04.98-09.01	110/120-125	JBH	0986 480 877	22
320 i	10.01-05.06	110/120-125	JBH	0986 480 868	23,8
	MFD 04.98-09.00	125	JBH	0986 481 010	
	OFD 04.98-09.01	125	JBH	0986 480 877	22
	10.01-05.06	137/141	JBH	0986 481 017	23,8
	OFD 09.00-09.01	141	JBH	0986 480 877	22
323 i	10.01-05.06	141	JBH	0986 480 868	23,8
	09.02-05.06	137	JBH	0986 480 868	23,8
	MFD 04.98-09.00	142	JBH	0986 481 010	
	OFD 04.98-09.00	142	JBH	0986 480 877	22
	MFD 03.03-05.06	150	JBH	0986 481 017	23,8
330 d	05.00-09.00	170	JBH	0986 481 011	
	10.00-05.06	170	JBH	0986 481 017	23,8
	OFD 05.00-09.01	170	JBH	0986 480 882	23,8
	10.01-05.06	170	JBH	0986 480 868	23,8

M 3	09.00-03.01	252		0986 486 049	19,05
	04.01-05.06	252		0986 486 065	19,05
M 3 CSL	03.03-12.03	265		0986 486 065	19,05
316 i	10.99-03.01	75		0986 486 049	19,05
	04.01-09.02	75		0986 486 065	19,05
	03.02-05.06	85		0986 486 065	19,05
318 i	04.99-03.01	87		0986 486 049	19,05
	04.01-09.01	87		0986 486 065	19,05
	09.01-05.06	105-110		0986 486 065	19,05
320 d	09.03-05.06	110		0986 486 065	19,05

		S							
320i		04.98-03.01	110				0 986 486 049	19,05	
		09.00-03.01	120-125				0 986 486 049	19,05	
		04.01-09.01	110				0 986 486 065	19,05	
		04.01-05.06	120-125				0 986 486 065	19,05	
323i		04.98-09.00	125				0 986 486 049	19,05	
325i		09.00-03.01	141				0 986 486 049	19,05	
		04.01-05.06	141				0 986 486 065	19,05	
		09.02-05.06	137				0 986 486 065	19,05	
328i		04.98-09.00	142				0 986 486 049	19,05	
330d		03.03-05.06	150				0 986 486 065	19,05	
330i		05.00-03.01	170				0 986 486 049	19,05	
		04.01-05.06	170				0 986 486 065	19,05	
	M 3	09.00-05.06	252				0 986 486 552	22	
	316i	10.99-05.06	75/85				0 986 486 552	22	
	318i	04.99-05.06	87/105-110				0 986 486 552	22	
	320d, i	04.98-05.06	110/120-125				0 986 486 552	22	
	323i	04.98-09.00	125				0 986 486 552	22	
	325i	09.00-05.06	137/141				0 986 486 552	22	
	328i	04.98-09.00	142				0 986 486 552	22	
	330d, i	05.00-05.06	150/170				0 986 486 552	22	
Serie 3 Coupé [E 92]									
									
	M 3	05.07-06.13	309				0 986 486 065	19,05	
	316i	09.07-06.13	90				0 986 486 065	19,05	
	318i	03.10-06.13	105				0 986 486 065	19,05	
	320d, d xDrive, i	03.07-06.13	115/120-135				0 986 486 065	19,05	
	323i	09.06-02.12	130				0 986 486 065	19,05	
	325d, i, i xDrive, xi	09.06-06.13	145/150/155-160				0 986 486 065	19,05	
	328i	09.06-06.13	172				0 986 486 065	19,05	
	330d, d xDrive, i, i xDrive, xd, xi	09.06-06.13	170/180/200				0 986 486 065	19,05	
	335i, i xDrive, xi	09.06-06.13	225-240				0 986 486 065	19,05	
	M 3	05.07-06.13	309				0 986 486 607	22,2	
	316i	09.07-06.13	90				0 986 486 607	22,2	
	318i	03.10-06.13	105				0 986 486 607	22,2	
	320d, d xDrive, i	03.07-06.13	115/120-135				0 986 486 607	22,2	
	323i	09.06-10.06	130				0 986 486 534	22,2	
		11.06-02.12	130				0 986 486 607	22,2	
	325d, i	03.07-06.13	145/150/155-160				0 986 486 607	22,2	
	325i, i xDrive, xi	11.06-06.13	160				0 986 486 607	22,2	
	325i, xi	09.06-10.06	160				0 986 486 534	22,2	
	328i	09.06-10.06	172				0 986 486 534	22,2	
		11.06-06.13	172				0 986 486 607	22,2	
	330d, d xDrive	09.08-06.13	180				0 986 486 607	22,2	
	330d	09.06-10.06	170				0 986 486 534	22,2	
	330xd	11.06-08.08	170				0 986 486 607	22,2	
	330i, i xDrive, xi	11.06-06.13	200				0 986 486 607	22,2	
	330i, xi	09.06-10.06	200				0 986 486 534	22,2	
	335i	09.06-10.06	225				0 986 486 534	22,2	
		11.06-02.10	225				0 986 486 607	22,2	
	335i xDrive, xi	09.07-02.10	225				0 986 486 607	22,2	
	335i, i xDrive	03.10-06.13	225-240				0 986 486 607	22,2	
	320d xDrive	09.08-06.13	120-135				0 265 236 381 ^T		
	325i xDrive, xi	09.06-06.13	160				0 265 236 381 ^T		
	330d xDrive, i xDrive, xd, xi	09.06-06.13	170/180/200				0 265 236 381 ^T		
	335i xDrive, xi	09.07-06.13	225-240				0 265 236 381 ^T		





◀ BMW Serie 3 Coupé [E 92]











	320 d xDrive	09.08-08.09	130		0 265 005 711	
		09.09-02.10	130		0 265 005 713	
		03.10-06.13	120-135		0 265 005 713	
	325 i xDrive	09.09-06.13	160		0 265 005 713	
	325 i xDrive, xi	09.06-08.09	160		0 265 005 711	
	330 d xDrive, i xDrive	09.09-06.13	180/200		0 265 005 713	
	330 d xDrive, i xDrive, xi	09.06-08.09	180/200		0 265 005 711	
	330 xd	09.06-08.08	170		0 265 005 711	
	335 i xDrive	09.09-02.10	225		0 265 005 713	
		03.10-06.13	225-240		0 265 005 713	
335 i xDrive, xi	09.07-08.09	225		0 265 005 711		

Serie 3 [E 36]



	M 3	01.94-09.95	210		JBH	0 986 480 950	25,4	
		M 3 3.2	10.95-12.97	236		JBH GIR	0 986 480 603	20,6
	316 i	09.96-06.98	179		JBH	0 986 480 950	25,4	
		09.90-02.94	73-75		JBH GIR	0 986 480 600	23,81	
		09.93-09.94	75		JBH ATE	0 986 480 640	23,8	
		10.94-12.98	75		JBH ATE	0 986 480 931	23,81	
		ABO 10.91-10.94	85		JBH GIR	0 986 480 600	23,81	
		ABS 09.90-09.94	73-75/85		JBH ATE	0 986 480 640	23,8	
	318 i	12.90-02.94	83-85		JBH ATE	0 986 480 640	23,8	
					GIR	0 986 480 600	23,81	
			11.92-09.94	85		JBH	0 986 480 640	23,8
			09.93-09.94	85		JBH ATE	0 986 480 640	23,8
		10.94-08.98	103		JBH ATE	0 986 480 931	23,81	
		10.94-10.98	85		JBH	0 986 480 931	23,81	
		10.94-12.98	85		JBH ATE	0 986 480 931	23,81	
318 i, is		03.92-09.94	103		JBH ATE	0 986 480 640	23,8	
318 is		10.94-12.98	103		JBH ATE	0 986 480 931	23,81	
		07.96-10.98	103		JBH	0 986 480 931	23,81	
318 tds	10.94-03.98	66		JBH ATE	0 986 480 931	23,81		
320 i	09.90-09.94	110		JBH ATE	0 986 480 640	23,8		
	09.90-12.95	110		JBH GIR	0 986 480 600	23,81		
	10.91-08.94	95		JBH	0 986 480 640	23,8		
	09.94-09.96	110		JBH,TKO ATE	0 986 480 640	23,8		
	09.94-10.96	95		JBH	0 986 480 931	23,81		
	09.94-12.98	110		JBH,TKO ATE	0 986 480 931	23,81		
	10.94-12.95	110		JBH ATE	0 986 480 931	23,81		
	10.96-12.98	110		JBH,TKO ATE	0 986 480 931	23,81		
	323 i	10.94-09.96	125		JBH,TKO ATE	0 986 480 640	23,8	
		10.94-12.98	125		JBH,TKO ATE	0 986 480 931	23,81	
03.96-09.96		140		JBH,TKO ATE	0 986 480 640	23,8		
03.96-04.99		140		JBH,TKO ATE	0 986 480 931	23,81		
10.96-10.98		125		JBH,TW	0 986 480 640	23,8		
					0 986 480 931	23,81		
	10.96-12.98	125		JBH,TKO ATE	0 986 480 931	23,81		
	10.96-04.99	140		JBH,TKO ATE	0 986 480 931	23,81		
325 i	09.90-09.94	141		JBH,TKO ATE	0 986 480 640	23,8		
	09.90-12.95	141		JBH,TKO ATE	0 986 480 640	23,8		
	04.91-09.94	138		JBH	0 986 480 640	23,8		
	10.94-08.95	138		JBH	0 986 480 931	23,81		
	10.94-12.95	141		JBH,TKO ATE	0 986 480 931	23,81		
325 td	09.91-09.94	85		JBH,TKO ATE	0 986 480 640	23,8		
	09.91-09.96	85		JBH,TKO ATE	0 986 480 640	23,8		
	09.91-12.98	85		JBH GIR	0 986 480 600	23,81		
	10.94-12.98	85		JBH,TKO ATE	0 986 480 931	23,81		
	10.96-12.98	85		JBH,TKO ATE	0 986 480 931	23,81		
325 tds	05.93-09.94	105		JBH,TKO ATE	0 986 480 640	23,8		
	05.93-09.96	105		JBH,TKO ATE	0 986 480 640	23,8		



		S							
325 tds		10.94-12.98	105			JBH,TKO ATE	0 986 480 931	23,81	
		10.96-12.98	105			JBH,TKO ATE	0 986 480 931	23,81	
328 i		10.94-09.96	142			JBH,TKO ATE	0 986 480 640	23,8	
		10.94-12.98	142			JBH,TKO ATE	0 986 480 931	23,81	
		08.95-10.98	148			JBH,TW	0 986 480 640	23,8	
		10.96-12.98	142			JBH,TKO ATE	0 986 480 931	23,81	
316 i		09.90-02.94	73-75			GIR	0 986 485 122		
		ABO 10.91-10.94	85			GIR	0 986 485 122		
318 i		12.90-02.94	83-85			BHO,LLE GIR	0 986 485 122		
						RLE GIR	0 986 485 122		
		09.93-12.98	85			RLE GIR	0 986 485 122		
M 3		01.94-10.94	210			RGR	0 986 486 017	19	
		11.94-09.95	210			RGS	0 986 486 034	19,05	
M 3 3.2		10.95-05.97	236			RGS	0 986 486 034	19,05	
		09.96-05.97	179				0 986 486 034	19,05	
		06.97-12.97	236				0 986 486 040	19,05	
		06.97-06.98	179				0 986 486 040	19,05	
316 i		09.90-02.94	73-75			RGR	0 986 486 017	19	
		09.93-10.94	75			RGR	0 986 486 017	19	
		11.94-05.97	75			RGS	0 986 486 034	19,05	
		06.97-12.98	75				0 986 486 040	19,05	
318 i		12.90-02.94	83-85			RGR	0 986 486 017	19	
		09.93-10.94	85				0 986 486 017	19	
		11.94-05.97	85				0 986 486 034	19,05	
		06.97-12.98	85				0 986 486 040	19,05	
318 i		03.92-10.94	103			RGR	0 986 486 017	19	
318 is		11.94-05.97	103			RGS	0 986 486 034	19,05	
		06.97-12.98	103				0 986 486 040	19,05	
318 is		06.97-10.98	103				F 026 A05 922		
318 tds		10.94-10.94	66			RGR	0 986 486 017	19	
		11.94-05.97	66			RGS	0 986 486 034	19,05	
		06.97-03.98	66				0 986 486 040	19,05	
320 i		09.90-10.94	110				0 986 486 017	19	
		09.94-10.94	110			RGR	0 986 486 017	19	
		11.94-12.95	110				0 986 486 034	19,05	
		11.94-05.97	110			RGS	0 986 486 034	19,05	
		06.97-12.98	110				0 986 486 040	19,05	
323 i		10.94-10.94	125			RGR	0 986 486 017	19	
		11.94-05.97	125			RGS	0 986 486 034	19,05	
		06.97-12.98	125				0 986 486 040	19,05	
325 i		09.90-10.94	141			RGR	0 986 486 017	19	
		11.94-12.95	141			RGS	0 986 486 034	19,05	
325 td		09.91-10.94	85/105			RGR	0 986 486 017	19	
325 tds		11.94-05.97	85/105			RGS	0 986 486 034	19,05	
		06.97-12.98	85/105				0 986 486 040	19,05	
328 i		10.94-05.97	142				0 986 486 034	19,05	
		06.97-12.98	142				0 986 486 040	19,05	
M 3, 3.2		01.94-06.98	179/210/236				0 986 486 534	22,2	
316 i		09.90-12.98	73-75/85				0 986 486 533	20,64	
318 i, is, tds		12.90-12.98	66/83-85/103				0 986 486 533	20,64	
320 i		09.90-12.98	95/110				0 986 486 533	20,64	
323 i		10.94-12.98	125				0 986 486 533	20,64	
325 i, td, tds		09.90-12.98	85/105/138/141				0 986 486 533	20,64	
328 i		10.94-12.98	142/148				0 986 486 533	20,64	



















◀ BMW

Serie 3 [E 46]

























	316 i	04.04-03.05	85	JBH	0986 481 017	23,8	
		MFD	04.98-09.00	75/77	JBH	0986 481 010	
			10.01-09.02	75/77	JBH	0986 481 017	23,8
			02.02-03.04	85	JBH	0986 481 017	23,8
		OFD	04.98-09.01	75/77	JBH	0986 480 877	22
		10.01-09.02	75/77	JBH	0986 480 868	23,8	
		02.02-03.04	85	JBH	0986 480 868	23,8	
	318 d		03.03-03.05	85	JBH	0986 481 017	23,8
		MFD	09.01-03.03	85	JBH	0986 481 017	23,8
		OFD	09.01-03.03	85	JBH	0986 480 868	23,8
	318 i		04.04-03.05	105	JBH	0986 481 017	23,8
		MFD	04.98-09.00	87	JBH	0986 481 010	
			09.01-03.04	105	JBH	0986 481 017	23,8
		OFD	04.98-09.01	87	JBH	0986 480 877	22
			09.01-03.04	105	JBH	0986 480 868	23,8
320 d	MFD	09.01-03.05	110	JBH	0986 481 017	23,8	
	OFD	09.01-03.05	110	JBH	0986 480 868	23,8	
320 d	MFD	04.98-09.00	100	JBH	0986 481 010		
320 i	OFD	04.98-09.01	100	JBH	0986 480 877	22	
320 i	MFD	12.98-09.00	110	JBH	0986 481 010		
		10.01-03.05	120-125	JBH	0986 481 017	23,8	
	OFD	04.98-09.01	110	JBH	0986 480 877	22	
		09.00-09.01	120-125	JBH	0986 480 877	22	
		10.01-03.05	120-125	JBH	0986 480 868	23,8	
323 i	MFD	04.98-09.00	125	JBH	0986 481 010		
		10.01-12.03	135	JBH	0986 481 017	23,8	
	OFD	04.98-09.00	125	JBH	0986 480 877	22	
		03.99-09.01	135	JBH	0986 480 877	22	
		10.01-12.03	135	JBH	0986 480 868	23,8	
325 i	MFD	10.01-03.05	137/141	JBH	0986 481 017	23,8	
	OFD	09.00-09.01	141	JBH	0986 480 877	22	
		10.01-03.05	141	JBH	0986 480 868	23,8	
		09.02-12.04	137	JBH	0986 480 868	23,8	
328 i	MFD	11.98-09.00	142	JBH	0986 481 010		
	OFD	04.98-09.00	142	JBH	0986 480 877	22	
330 d		03.03-03.05	150	JBH	0986 481 017	23,8	
330 d	MFD	10.99-09.00	135/170	JBH	0986 481 011		
330 i		10.00-04.05	135/170	JBH	0986 481 017	23,8	
	OFD	10.99-09.01	135/170	JBH	0986 480 882	23,8	
		10.01-04.05	135/170	JBH	0986 480 868	23,8	

	316 i	04.98-03.01	75/77		0986 486 049	19,05	
			04.01-09.02	75/77	0986 486 065	19,05	
			02.02-03.05	85	0986 486 065	19,05	
	318 d		09.01-03.05	85	0986 486 065	19,05	
	318 i		04.98-03.01	87		0986 486 049	19,05
			11.98-09.01	87		0986 486 065	19,05
			09.01-03.05	105		0986 486 065	19,05
	320 d		04.98-03.01	100		0986 486 049	19,05
			04.01-09.01	100		0986 486 065	19,05
	320 d, i		04.01-03.05	110		0986 486 065	19,05
	320 i		04.98-09.00	100		0986 486 065	19,05
			04.98-03.01	110		0986 486 049	19,05
			09.00-03.01	120-125		0986 486 049	19,05
			04.01-03.05	120-125		0986 486 065	19,05
	323 i		04.98-09.00	125		0986 486 049	19,05
		03.99-03.01	135		0986 486 049	19,05	
		04.01-12.03	135		0986 486 065	19,05	
325 i		09.02-12.04	137		0986 486 065	19,05	

		S							
325 i		09.00-03.01	141				0 986 486 049	19,05	
325 xi		04.01-03.05	141				0 986 486 065	19,05	
328 i		04.98-09.00	142				0 986 486 049	19,05	
		11.98-09.00	142				0 986 486 065	19,05	
330 d		10.99-03.01	135				0 986 486 049	19,05	
330 xd		04.01-04.03	135				0 986 486 065	19,05	
		03.03-03.05	150				0 986 486 065	19,05	
330 i		05.00-03.01	170				0 986 486 049	19,05	
330 xi		04.01-04.05	170				0 986 486 065	19,05	
<hr/>									
	316 i	04.98-03.05	75/77/85				0 986 486 552	22	
	318 d, i	04.98-03.05	85/87/105				0 986 486 552	22	
	320 d, i	04.98-03.05	100/110/120-125				0 986 486 552	22	
	323 i	04.98-12.03	125/135				0 986 486 552	22	
	325 i, xi	09.00-03.05	137/141				0 986 486 552	22	
	328 i	04.98-09.00	142				0 986 486 552	22	
	330 d, i, xd, xi	10.99-04.05	135/150/170				0 986 486 552	22	
<hr/>									
	325 xi	09.00-03.05	141				0 265 225 153 ^T		
	330 xd, xi	07.00-03.05	135/150/170				0 265 225 153 ^T		
<hr/>									
	325 xi	09.00-03.05	141				0 265 005 248		
	330 xd, xi	07.00-03.05	135/150/170				0 265 005 248		
<hr/>									
	330 xi	07.00-03.05	170				0 265 005 303		
<hr/>									
Serie 3 [E 90]									
<hr/>									
									
<hr/>									
	M 3	11.07-10.11	309				0 986 486 065	19,05	
	316 d, i	09.05-10.11	85/90				0 986 486 065	19,05	
	318 d, i	09.05-10.11	90/95-105				0 986 486 065	19,05	
	320 d, d ed, d xDrive, i, si	03.05-12.11	110-115/120-135				0 986 486 065	19,05	
	323 i	09.05-12.11	130				0 986 486 065	19,05	
	325 d, i, i xDrive, xi	03.05-12.11	145/150/155-160				0 986 486 065	19,05	
	328 i	09.06-07.11	170-172				0 986 486 065	19,05	
	330 d, d xDrive, i, i xDrive, xd, xi	03.05-12.11	170/180/190-200				0 986 486 065	19,05	
	335 d, i, i xDrive, xi	09.06-12.11	210/225-240				0 986 486 065	19,05	
<hr/>									
	M 3	11.07-10.11	309				0 986 486 607	22,2	
	316 d, i	11.06-10.11	85				0 986 486 607	22,2	
	316 i	09.05-10.06	85				0 986 486 534	22,2	
		09.07-10.11	90				0 986 486 607	22,2	
	318 d	09.05-10.06	90/95-100				0 986 486 534	22,2	
	318 i	11.06-10.11	90/95-100				0 986 486 607	22,2	
		09.07-10.11	100-105				0 986 486 607	22,2	
	320 d	03.05-04.05	120				0 986 486 607	22,2	
		05.05-10.06	120				0 986 486 534	22,2	
		09.05-10.06	110				0 986 486 534	22,2	
		11.06-09.07	110				0 986 486 607	22,2	
			120				0 986 486 607	22,2	
		09.07-03.10	130				0 986 486 607	22,2	
	320 d ed	03.10-11.11	120				0 986 486 607	22,2	
	320 d, d xDrive, i	09.07-12.11	120-135				0 986 486 607	22,2	
	320 i	03.05-04.05	110-115				0 986 486 607	22,2	
		05.05-10.06	110-115				0 986 486 534	22,2	
		11.06-12.11	110-115				0 986 486 607	22,2	
	320 si	03.06-09.06	127				0 986 486 534	22,2	
	323 i	09.05-10.06	130				0 986 486 534	22,2	
		11.06-12.11	130				0 986 486 607	22,2	



		S							
 ◀ BMW Serie 3 [E 90]									
325 d	09.06-10.06	145					0 986 486 534	22,2	
	11.06-02.10	145					0 986 486 607	22,2	
325 d, i	09.07-12.11	150/155-160					0 986 486 607	22,2	
325 i	03.05-04.05	160					0 986 486 607	22,2	
	11.06-12.11	160					0 986 486 607	22,2	
325 i xDrive, xi	11.06-10.11	160					0 986 486 607	22,2	
325 i, xi	05.05-10.06	160					0 986 486 534	22,2	
328 i	09.06-10.06	170-172					0 986 486 534	22,2	
	11.06-07.11	170-172					0 986 486 607	22,2	
330 d, d xDrive	09.08-12.11	180					0 986 486 607	22,2	
330 d	09.05-10.06	170					0 986 486 534	22,2	
330 xd	11.06-08.08	170					0 986 486 607	22,2	
330 i	03.05-04.05	190-200					0 986 486 607	22,2	
	05.05-10.06	190-200					0 986 486 534	22,2	
	11.06-12.11	190-200					0 986 486 607	22,2	
330 i, i xDrive, xi	09.07-10.11	200					0 986 486 607	22,2	
330 xi	09.05-10.06	190-200					0 986 486 534	22,2	
	11.06-09.07	190-200					0 986 486 607	22,2	
335 d, i	09.06-10.06	210/225					0 986 486 534	22,2	
335 d, i, i xDrive, xi	11.06-10.11	210/225					0 986 486 607	22,2	
335 i, i xDrive	03.10-12.11	225-240					0 986 486 607	22,2	
									
320 d xDrive	09.08-10.11	120-135					0 265 236 381 ^T		
325 i xDrive, xi	09.05-10.11	160					0 265 236 381 ^T		
330 d xDrive, i xDrive, xd, xi	09.05-10.11	170/180/190/200					0 265 236 381 ^T		
335 i xDrive, xi	03.07-10.11	225-240					0 265 236 381 ^T		
									
320 d xDrive	09.08-08.09	120-130					0 265 005 711		
	09.09-02.10	120-130					0 265 005 713		
	03.10-10.11	120-135					0 265 005 713		
325 i xDrive	09.09-10.11	160					0 265 005 713		
325 i xDrive, xi	09.05-08.09	160					0 265 005 711		
330 d xDrive	09.08-08.09	180					0 265 005 711		
	09.09-10.11	180					0 265 005 713		
330 i xDrive	09.09-10.11	200					0 265 005 713		
330 i xDrive, xi	09.07-08.09	200					0 265 005 711		
330 xd	09.05-08.08	170					0 265 005 711		
330 xi	09.05-09.07	190					0 265 005 711		
335 i xDrive	09.09-02.10	225					0 265 005 713		
	03.10-10.11	225-240					0 265 005 713		
335 i xDrive, xi	03.07-08.09	225					0 265 005 711		
Serie 3 [F 30]									
									
									
ActiveHybrid	09.12→	225-250			LLE		0 204 781 585	25,4	
					RLE		0 204 781 589	25,4	
316 d	03.12→	85/100			LLE, SBJ		0 204 781 585	25,4	
					LLE, SBJ		0 204 776 585	23,81	
316 i					RLE, SBJ		0 204 781 589	25,4	
					LLE, SSJ		0 204 781 585	25,4	
					LLE, SSJ		0 204 776 585	23,81	
318 d	03.12→	105			RLE, SSJ		0 204 781 589	25,4	
					LLE, SBJ		0 204 781 585	25,4	
					LLE, SBJ		0 204 776 585	23,81	
318 d xDrive	07.15→	110			RLE, SBJ		0 204 781 589	25,4	
					LLE, SBJ		0 204 781 585	25,4	
					LLE, SBJ		0 204 776 585	23,81	
318 d xDrive	07.13→	105			SBJ		0 204 781 585	25,4	
					SBJ		0 204 776 585	23,81	
					SBJ		0 204 781 585	25,4	
					SBJ		0 204 776 585	23,81	

		S							
318 i		07.15→	100			LLE, SBJ	0 204 781 585	25,4	
						LLE, SBJ	0 204 776 585	23,81	
						RLE, SBJ	0 204 781 589	25,4	
320 d		02.12-06.15	135-147			LLE	0 204 781 585	25,4	
						RLE	0 204 781 589	25,4	
		07.15→	135-147			SBJ	0 204 817 842	26,99	
						SBJ	0 204 781 589	25,4	
320 d ed		02.12→	120			LLE, SSJ	0 204 781 585	25,4	
						LLE, SSJ	0 204 776 585	23,81	
						RLE, SSJ	0 204 781 589	25,4	
		07.15→	120			LLE, SBJ	0 204 776 585	23,81	
						SBJ	0 204 781 585	25,4	
320 d xDrive		07.12→	135-147			LLE	0 204 781 585	25,4	
						RLE	0 204 781 589	25,4	
320 d		07.15→	140			LLE, SBJ	0 204 817 839		
320 d xDrive						LLE, SBJ	0 204 781 585	25,4	
						RLE, SBJ	0 204 817 842	26,99	
						RLE, SBJ	0 204 781 589	25,4	
320 i		03.12→	135			LLE, SSJ	0 204 781 585	25,4	
						LLE, SSJ	0 204 776 585	23,81	
						RLE, SSJ	0 204 781 589	25,4	
		07.15→	135			LLE, SBJ	0 204 781 585	25,4	
						LLE, SBJ	0 204 776 585	23,81	
						RLE, SBJ	0 204 781 589	25,4	
320 i ed		11.12-06.15	125			LLE, SBJ	0 204 781 585	25,4	
						LLE, SBJ	0 204 776 585	23,81	
						RLE, SBJ	0 204 781 589	25,4	
		07.15→	125				0 204 776 585	23,81	
320 i xDrive		07.12→	135			GBM, LLE	0 204 781 585	25,4	
						GBM, RLE	0 204 781 589	25,4	
						GBM, LLE	0 204 776 585	23,81	
323 d		03.13→	160			LLE	0 204 781 585	25,4	
						RLE	0 204 781 589	25,4	
328 i		02.12→	180			LLE	0 204 781 585	25,4	
						RLE	0 204 781 589	25,4	
328 i xDrive		07.12→	180				0 204 781 585	25,4	
330 d		07.12→	190-210			LLE	0 204 781 585	25,4	
						RLE	0 204 781 589	25,4	
330 i		07.15→	185			LLE, SBJ	0 204 817 839		
						LLE, SBJ	0 204 781 585	25,4	
						RLE, SBJ	0 204 817 842	26,99	
						RLE, SBJ	0 204 781 589	25,4	
330 i xDrive		07.15→	185			SBJ	0 204 817 839		
						SBJ	0 204 781 585	25,4	
335 d xDrive		02.12→	225-250			LLE	0 204 781 585	25,4	
335 i						RLE	0 204 781 589	25,4	
335 i xDrive		07.12→	225-240				0 204 781 585	25,4	
340 i		07.15→	240			LLE, SBJ	0 204 817 839		
						LLE, SBJ	0 204 781 585	25,4	
						RLE, SBJ	0 204 817 842	26,99	
						RLE, SBJ	0 204 781 589	25,4	
340 i xDrive		07.15→	240			SBJ	0 204 817 839		
						SBJ	0 204 781 585	25,4	
 316 d, i		03.12→	85/100				0 986 486 065	19,05	
318 d, d xDrive, i		03.12→	100/105/110				0 986 486 065	19,05	
320 d, d ed, d xDrive, i, i ed, i xDrive		02.12→	120/125/135-147				0 986 486 065	19,05	
323 d		03.13→	160				0 986 486 065	19,05	
328 i, i xDrive		02.12→	180				0 986 486 065	19,05	
330 i		07.15→	185				0 986 486 065	19,05	
335 i, i xDrive		02.12→	225-250				0 986 486 065	19,05	
340 i, i xDrive		07.15→	240				0 986 486 065	19,05	



		S							
◀ BMW									
Serie 3 [F 80]									
	M 3	06.14→	317			LLE	0 204 817 839		
						RLE	0 204 817 842	26,99	
	M 3	06.14→	317				0 986 486 065	19,05	
Serie 3 GT [F 34]									
	318 d	06.13→	105/110			LLE, SBJ	0 204 781 585	25,4	
						LLE, SBJ	0 204 776 585	23,81	
						RLE, SBJ	0 204 781 589	25,4	
	320 d	06.13→	135			LLE	0 204 781 585	25,4	
						RLE	0 204 781 589	25,4	
	320 d xDrive	07.13→	135				0 204 781 585	25,4	
	320 d	07.15→	140			LLE	0 204 781 585	25,4	
	320 d xDrive					RLE	0 204 781 589	25,4	
	320 i	06.13→	135			LLE, SBJ	0 204 781 585	25,4	
	320 i xDrive					LLE, SBJ	0 204 776 585	23,81	
						RLE, SBJ	0 204 781 589	25,4	
	325 d	07.13→	160			LLE	0 204 781 585	25,4	
						RLE	0 204 781 589	25,4	
	325 i	06.13→	225			LLE	0 204 781 585	25,4	
						RLE	0 204 781 589	25,4	
	325 i xDrive	07.13→	225				0 204 781 585	25,4	
	328 i	06.13→	180			LLE	0 204 781 585	25,4	
						RLE	0 204 781 589	25,4	
	328 i xDrive	07.13→	180				0 204 781 585	25,4	
	330 d	03.14→	190-210			LLE	0 204 781 585	25,4	
	330 d xDrive					RLE	0 204 781 589	25,4	
	335 d xDrive	03.14→	230			LLE	0 204 781 585	25,4	
						RLE	0 204 781 589	25,4	
	318 d	06.13→	105/110				0 986 486 065	19,05	
	320 d, d xDrive, i, i xDrive	06.13→	135/140				0 986 486 065	19,05	
	325 d, i	06.13→	160/225				0 986 486 065	19,05	
	328 i	06.13→	180				0 986 486 065	19,05	
Serie 3 Touring [E 30]									
	316 i	09.91-06.94	73-75			JBH	0 986 480 599	22,2	
	318 i	04.89-06.94	83-85			JBH	0 986 480 599	22,2	
	316 i	09.91-06.94	73-75				0 986 486 042	19	
	318 i	04.89-06.94	83-85				0 986 486 042	19	
	316 i	09.91-06.94	73-75				0 986 486 500	20,64	
	318 i	04.89-06.94	83-85				0 986 486 500	20,64	
	316 i	09.91-06.94	73-75				0 265 200 040^H		
	318 i	04.89-06.94	83-85				0 265 200 040^H		
	316 i	09.91-06.94	73-75				0 265 103 041^H		
	318 i	04.89-06.94	83-85				0 265 103 041^H		





Serie 3 Touring [E 36]



	316 i	01.96-12.99	75	JBH	ATE	0 986 480 931	23,81
	318 i, tds	03.95-12.99	66/85	JBH	ATE	0 986 480 931	23,81
	320 i	03.95-09.96	110	JBH,TKO	ATE	0 986 480 640	23,8
		03.95-12.99	110	JBH,TKO	ATE	0 986 480 931	23,81
		10.96-12.99	110	JBH,TKO	ATE	0 986 480 931	23,81
	323 i	10.95-09.96	125	JBH,TKO	ATE	0 986 480 640	23,8
		10.95-06.99	125	JBH,TKO	ATE	0 986 480 931	23,81
		10.96-06.99	125	JBH,TKO	ATE	0 986 480 931	23,81
	325 tds	09.95-12.99	105	JBH	ATE	0 986 480 931	23,81
	328 i	03.95-09.96	142	JBH,TKO	ATE	0 986 480 640	23,8
		03.95-12.99	142	JBH,TKO	ATE	0 986 480 931	23,81
		10.96-12.99	142	JBH,TKO	ATE	0 986 480 931	23,81

	316 i	01.96-05.97	75	RGS		0 986 486 034	19,05
		06.97-12.99	75			0 986 486 040	19,05
	318 i	03.95-05.97	66/85	RGS		0 986 486 034	19,05
	318 tds	06.97-12.99	66/85			0 986 486 040	19,05
	320 i	03.95-05.97	110	RGS		0 986 486 034	19,05
		06.97-12.99	110			0 986 486 040	19,05
	323 i	10.95-05.97	125	RGS		0 986 486 034	19,05
		06.97-06.99	125			0 986 486 040	19,05
	325 tds	09.95-05.97	105	RGS		0 986 486 034	19,05
		06.97-12.99	105			0 986 486 040	19,05
	328 i	03.95-05.97	142			0 986 486 034	19,05
		06.97-12.99	142			0 986 486 040	19,05

	316 i	01.96-12.99	75			0 986 486 533	20,64
	318 i, tds	03.95-12.99	66/85			0 986 486 533	20,64
	320 i	03.95-12.99	110			0 986 486 533	20,64
	323 i	10.95-06.99	125			0 986 486 533	20,64
	325 tds	09.95-12.99	105			0 986 486 533	20,64
	328 i	03.95-12.99	142			0 986 486 533	20,64

Serie 3 Touring [E 46]



	316 i	04.04-09.05	85	JBH		0 986 481 017	23,8
		MFD 03.02-03.04	85	JBH		0 986 481 017	23,8
		OFD 03.02-03.04	85	JBH		0 986 480 868	23,8
	318 d	03.03-09.05	85	JBH		0 986 481 017	23,8
		MFD 03.02-03.03	85	JBH		0 986 481 017	23,8
		OFD 03.02-03.03	85	JBH		0 986 480 868	23,8
	318 i	04.04-03.05	105	JBH		0 986 481 017	23,8
		MFD 10.99-09.00	87	JBH		0 986 481 010	
		09.01-03.04	105	JBH		0 986 481 017	23,8
		OFD 10.99-09.01	87	JBH		0 986 480 877	22
		09.01-03.04	105	JBH		0 986 480 868	23,8
	320 d	MFD 10.99-09.00	100	JBH		0 986 481 010	
		09.01-09.05	110	JBH		0 986 481 017	23,8
		OFD 10.99-09.01	100	JBH		0 986 480 877	22
		09.01-09.05	110	JBH		0 986 480 868	23,8
	320 i	MFD 10.99-09.00	110	JBH		0 986 481 010	
		10.01-09.05	120-125	JBH		0 986 481 017	23,8
		OFD 10.99-09.01	110	JBH		0 986 480 877	22
		09.00-09.01	120-125	JBH		0 986 480 877	22
		10.01-09.05	120-125	JBH		0 986 480 868	23,8
	323 i	MFD 10.98-09.00	125	JBH		0 986 481 010	
		OFD 10.98-09.00	125	JBH		0 986 480 877	22





	BMW Serie 3 Touring [E 46]							
325 i	MFD	10.01-09.05	137/141		JBH	0 986 481 017	23,8	
	OFD	09.00-09.01	141		JBH	0 986 480 877	22	
		10.01-09.05	141		JBH	0 986 480 868	23,8	
		09.02-01.05	137		JBH	0 986 480 868	23,8	
328 i	MFD	10.99-09.00	142		JBH	0 986 481 010		
	OFD	10.99-09.00	142		JBH	0 986 480 877	22	
330 d		03.03-09.05	150		JBH	0 986 481 017	23,8	
330 d	MFD	10.99-09.00	135/170		JBH	0 986 481 011		
330 i		10.00-09.05	135/170		JBH	0 986 481 017	23,8	
	OFD	10.99-09.01	135/170		JBH	0 986 480 882	23,8	
		10.01-09.05	135/170		JBH	0 986 480 868	23,8	

	316 i		03.02-09.05	85		0 986 486 065	19,05	
	318 d		03.02-09.05	85		0 986 486 065	19,05	
318 i			10.99-03.01	87		0 986 486 049	19,05	
			04.01-09.01	87		0 986 486 065	19,05	
			09.01-03.05	105		0 986 486 065	19,05	
320 d			10.99-03.01	100		0 986 486 049	19,05	
			04.01-09.01	100		0 986 486 065	19,05	
320 d, i			04.01-09.05	110		0 986 486 065	19,05	
320 i			10.99-03.01	110		0 986 486 049	19,05	
			09.00-03.01	120-125		0 986 486 049	19,05	
			04.01-09.05	120-125		0 986 486 065	19,05	
323 i			10.98-09.00	125		0 986 486 049	19,05	
325 i			09.02-01.05	137		0 986 486 065	19,05	
325 i			09.00-03.01	141		0 986 486 049	19,05	
325 xi			04.01-09.05	141		0 986 486 065	19,05	
328 i			10.99-09.00	142		0 986 486 049	19,05	
330 d			10.99-03.01	135		0 986 486 049	19,05	
330 xd			04.01-03.03	135		0 986 486 065	19,05	
			03.03-09.05	150		0 986 486 065	19,05	
330 i			05.00-03.01	170		0 986 486 049	19,05	
330 xi			04.01-09.05	170		0 986 486 065	19,05	

	316 i		03.02-09.05	85		0 986 486 552	22	
	318 d, i		10.99-09.05	85/87/105		0 986 486 552	22	
320 d, i			10.99-09.05	100/110/120-125		0 986 486 552	22	
323 i			10.98-09.00	125		0 986 486 552	22	
325 i, xi			09.00-09.05	137/141		0 986 486 552	22	
328 i			10.99-09.00	142		0 986 486 552	22	
330 d, i, xd, xi			10.99-09.05	135/150/170		0 986 486 552	22	

	325 xi		09.00-09.05	141		0 265 225 153 ¹		
	330 xd, xi		07.00-09.05	135/150/170		0 265 225 153 ¹		











	325 xi		09.00-09.05	141		0 265 005 248		
	330 xd, xi		07.00-09.05	135/150/170		0 265 005 248		

Serie 3 Touring [E 91]



	316 d, i		09.08-05.12	85/90		0 986 486 065	19,05	
	318 d, i		03.06-05.12	90/95-105		0 986 486 065	19,05	
320 d, d ed, d xDrive, i			09.05-06.12	110-115/120-135		0 986 486 065	19,05	
323 i			09.05-05.12	130		0 986 486 065	19,05	
325 d, i, i xDrive, xi			09.05-05.12	145/150/155-160		0 986 486 065	19,05	
330 d, d xDrive, i, i xDrive, xd, xi			09.05-05.13	170/180/190-200		0 986 486 065	19,05	
335 d, i, i xDrive, xi			09.06-05.12	210/225-240		0 986 486 065	19,05	

	316 d, i		09.08-05.12	85/90		0 986 486 607	22,2	
--	----------	--	-------------	-------	--	---------------	------	--

		S									
318 d, i		03.06-10.06	90/95-100				0 986 486 534	22,2			
		11.06-03.10	90/95-100				0 986 486 607	22,2			
		09.07-05.12	100-105				0 986 486 607	22,2			
320 d, d ed, i		11.06-05.12	110-115/120			0 986 486 607	22,2				
320 d, d xDrive, i		09.07-06.12	120-135			0 986 486 607	22,2				
320 d, i		09.05-10.06	110-115/120			0 986 486 534	22,2				
323 i		09.05-10.06	130				0 986 486 534	22,2			
		11.06-05.12	130				0 986 486 607	22,2			
325 d		09.06-10.06	145				0 986 486 534	22,2			
		11.06-02.10	145				0 986 486 607	22,2			
325 d, i		09.07-05.12	150/155-160				0 986 486 607	22,2			
325 i, i xDrive, xi		11.06-05.12	160				0 986 486 607	22,2			
325 i, xi		09.05-10.06	160				0 986 486 534	22,2			
330 d, d xDrive		09.08-05.12	180				0 986 486 607	22,2			
330 d		09.05-10.06	170				0 986 486 534	22,2			
330 xd		11.06-08.08	170				0 986 486 607	22,2			
330 i, i xDrive, xi		09.07-05.13	200				0 986 486 607	22,2			
330 i		09.05-10.06	190-200				0 986 486 534	22,2			
330 xi		11.06-02.12	190-200				0 986 486 607	22,2			
335 d, i		09.06-10.06	210/225				0 986 486 534	22,2			
335 d, i, i xDrive, xi		11.06-05.12	210/225				0 986 486 607	22,2			
335 i, i xDrive		03.10-05.12	225-240				0 986 486 607	22,2			
		320 d xDrive	09.08-05.12	120-135			0 265 236 381 ^T				
		325 i xDrive, xi	09.05-05.12	160			0 265 236 381 ^T				
		330 d xDrive, i xDrive, xd, xi	09.05-05.12	170/180/190/200			0 265 236 381 ^T				
		335 i xDrive, xi	03.07-05.12	225-240			0 265 236 381 ^T				
		320 d xDrive	09.08-08.09	120-130			0 265 005 711				
			09.09-02.10	120-130			0 265 005 713				
			03.10-05.12	120-135			0 265 005 713				
		325 i xDrive	09.09-05.12	160			0 265 005 713				
		325 i xDrive, xi	09.05-08.09	160			0 265 005 711				
		330 d xDrive	09.08-08.09	180			0 265 005 711				
			09.09-05.12	180			0 265 005 713				
		330 i xDrive	09.09-05.12	200			0 265 005 713				
		330 i xDrive, xi	09.07-08.09	200			0 265 005 711				
		330 xd	09.05-08.08	170			0 265 005 711				
		330 xi	09.05-09.07	190			0 265 005 711				
		335 i xDrive	09.09-02.10	225			0 265 005 713				
			03.10-05.12	225-240			0 265 005 713				
			03.07-08.09	225			0 265 005 711				
		Serie 3 Touring [F 31]									
				316 d	11.12→	85/100			LLE, SBJ	0 204 781 585	25,4
316 i	LLE, SBJ			0 204 776 585	23,81						
	RLE, SBJ			0 204 781 589	25,4						
318 d	11.12→			105/110			LLE, SBJ	0 204 781 585	25,4		
	LLE, SBJ			0 204 776 585	23,81						
	RLE, SBJ			0 204 781 589	25,4						
318 d xDrive	07.13→			105/110			SBJ	0 204 781 585	25,4		
	SBJ			0 204 776 585	23,81						
318 i	07.15→			100			LLE, SBJ	0 204 781 585	25,4		
	LLE, SBJ			0 204 776 585	23,81						
	RLE, SBJ			0 204 781 589	25,4						
320 d ed	03.13→			120			GBM, LLE	0 204 781 585	25,4		
					GBM, RLE	0 204 781 589	25,4				
	07.15→			120			GBM, LLE	0 204 776 585	23,81		
					LLE	0 204 776 585	23,81				

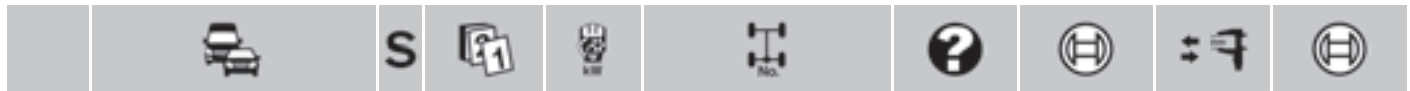















BMW Serie 3 Touring [F 31]

	320 d xDrive	03.13→	135	LLE	0 204 781 585	25,4
				RLE	0 204 781 589	25,4
	320 d	09.12→	135-147	LLE	0 204 781 585	25,4
	320 d xDrive			RLE	0 204 781 589	25,4
	320 i	11.12→	135	GBM,LLE	0 204 781 585	25,4
	320 i xDrive			GBM,RLE	0 204 781 589	25,4
				GBM,LLE	0 204 776 585	23,81
		07.15→	135	LLE,SBJ	0 204 781 585	25,4
				LLE,SBJ	0 204 776 585	23,81
				RLE,SBJ	0 204 781 589	25,4
	325 d	03.13→	160	LLE,SBJ	0 204 817 839	
				LLE,SBJ	0 204 781 585	25,4
				RLE,SBJ	0 204 817 842	26,99
				RLE,SBJ	0 204 781 589	25,4
	328 i	09.12→	180	LLE	0 204 781 585	25,4
				RLE	0 204 781 589	25,4
	328 i xDrive	03.13→	180		0 204 781 585	25,4
	330 d	09.12→	190	LLE,SBJ	0 204 817 839	
	330 d xDrive			LLE,SBJ	0 204 781 585	25,4
				RLE,SBJ	0 204 817 842	26,99
				RLE,SBJ	0 204 781 589	25,4
	330 i	07.15→	185	LLE,SBJ	0 204 817 839	
				LLE,SBJ	0 204 781 585	25,4
				RLE,SBJ	0 204 817 842	26,99
				RLE,SBJ	0 204 781 589	25,4
	330 i xDrive	07.15→	185	SBJ	0 204 817 839	
				SBJ	0 204 781 585	25,4
	335 d xDrive	11.13→	230	LLE,SBJ	0 204 817 839	
				LLE,SBJ	0 204 781 585	25,4
				RLE,SBJ	0 204 817 842	26,99
				RLE,SBJ	0 204 781 589	25,4
	335 i	03.13→	225	LLE	0 204 781 585	25,4
				RLE	0 204 781 589	25,4
	335 i xDrive	03.13→	225		0 204 781 585	25,4
	340 i	07.15→	240	LLE,SBJ	0 204 817 839	
				LLE,SBJ	0 204 781 585	25,4
				RLE,SBJ	0 204 817 842	26,99
				RLE,SBJ	0 204 781 589	25,4
	340 i xDrive	07.15→	240	SBJ	0 204 817 839	
				SBJ	0 204 781 585	25,4

	316 d, i	11.12→	85/100		0 986 486 065	19,05
	318 d, d xDrive, i	11.12→	100/105/110		0 986 486 065	19,05
	320 d, d ed, d xDrive, i, i xDrive	09.12→	120/135-147		0 986 486 065	19,05
	325 d	03.13→	160		0 986 486 065	19,05
	328 i, i xDrive	09.12→	180		0 986 486 065	19,05
	330 i	07.15→	185		0 986 486 065	19,05
	335 i, i xDrive	03.13→	225		0 986 486 065	19,05
	340 i, i xDrive	07.15→	240		0 986 486 065	19,05

Serie 4 Cabrio [F 33]

	420 d	03.14→	135	LLE	0 204 781 585	25,4
				RLE	0 204 781 589	25,4
		07.15→	140	LLE,SBJ	0 204 817 839	
				LLE,SBJ	0 204 781 585	25,4
				RLE,SBJ	0 204 817 842	26,99
				RLE,SBJ	0 204 781 589	25,4
	420 i	06.14→	135	LLE,SBJ	0 204 781 585	25,4
				LLE,SBJ	0 204 776 585	23,81
				RLE,SBJ	0 204 781 589	25,4

		S							
425 d		06.14→	160			LLE	0 204 781 585	25,4	
						RLE	0 204 781 589	25,4	
428 i		03.14→	180			LLE	0 204 781 585	25,4	
						RLE	0 204 781 589	25,4	
428 i xDrive		03.14→	180				0 204 781 585	25,4	
430 d		06.14→	190-210			LLE	0 204 781 585	25,4	
						RLE	0 204 781 589	25,4	
435 d		06.14→	230			LLE	0 204 781 585	25,4	
						RLE	0 204 781 589	25,4	
435 i		03.14→	225			LLE	0 204 781 585	25,4	
						RLE	0 204 781 589	25,4	
435 i xDrive		06.14→	225				0 204 781 585	25,4	
 420 d, i		03.14→	135/140				0 986 486 065	19,05	
425 d		06.14→	160				0 986 486 065	19,05	
428 i, i xDrive		03.14→	180				0 986 486 065	19,05	
435 i, i xDrive		03.14→	225				0 986 486 065	19,05	
Serie 4 Cabrio [F 83]									
									
 M 4		09.14→	317			LLE	0 204 817 839		
						RLE	0 204 817 842	26,99	
 M 4		09.14→	317				0 986 486 065	19,05	
Serie 4 Coupé [F 32]									
									
 418 d		03.15→	110			LLE, SBJ	0 204 781 585	25,4	
						LLE, SBJ	0 204 776 585	23,81	
						RLE, SBJ	0 204 781 589	25,4	
420 d		09.13-02.15	135			LLE	0 204 781 585	25,4	
						RLE	0 204 781 589	25,4	
		03.15→	140			LLE	0 204 781 585	25,4	
						RLE	0 204 781 589	25,4	
420 i		11.13→	135			LLE, SBJ	0 204 776 585	23,81	
						RLE, SBJ, TW	0 204 781 589	25,4	
						SBJ	0 204 781 585	25,4	
420 i xDrive		11.13→	135			SBJ, TW	0 204 781 585	25,4	
							0 204 781 589	25,4	
						SBJ, TW	0 204 776 585	23,81	
425 d		03.14→	160			LLE	0 204 781 585	25,4	
						RLE	0 204 781 589	25,4	
428 i		09.13→	180			LLE	0 204 781 585	25,4	
						RLE	0 204 781 589	25,4	
428 i xDrive		09.13→	180				0 204 781 585	25,4	
430 d		11.13→	190-210			LLE	0 204 781 585	25,4	
430 d xDrive						RLE	0 204 781 589	25,4	
435 d xDrive		11.13→	230			LLE	0 204 781 585	25,4	
						RLE	0 204 781 589	25,4	
435 i		09.13→	225			LLE	0 204 781 585	25,4	
						RLE	0 204 781 589	25,4	
435 i xDrive		09.13→	225				0 204 781 585	25,4	
 418 d		03.15→	110				0 986 486 065	19,05	
420 d, i, i xDrive		09.13→	135/140				0 986 486 065	19,05	
425 d		03.14→	160				0 986 486 065	19,05	
428 i, i xDrive		09.13→	180				0 986 486 065	19,05	
435 i, i xDrive		09.13→	225				0 986 486 065	19,05	



◀ BMW

Serie 4 Coupé [F 82]



	M 4	06.14→	317	LLE	0 204 817 839	
				RLE	0 204 817 842	26,99
	M 4	06.14→	317		0 986 486 065	19,05

Serie 4 GC [E 36]



	430 d xDrive	06.14→	190-210	LLE	0 204 781 585	25,4
				RLE	0 204 781 589	25,4

Serie 4 GC [F 36]



	418 d	05.14→	105/110	LLE, SBJ	0 204 781 585	25,4
				LLE, SBJ	0 204 776 585	23,81
				RLE, SBJ	0 204 781 589	25,4
	418 i	07.15→	100	SBJ	0 204 781 585	25,4
				SBJ	0 204 776 585	23,81
	420 d	05.14-03.15	135	LLE	0 204 781 585	25,4
	420 d xDrive	03.15→	140	RLE	0 204 781 589	25,4
				LLE	0 204 781 585	25,4
				RLE	0 204 781 589	25,4
	420 i	05.14→	135	SBJ, TW	0 204 781 589	25,4
	420 i, i xDrive	05.14→	135	SBJ	0 204 781 585	25,4
	428 i	05.14→	180	LLE	0 204 781 585	25,4
				RLE	0 204 781 589	25,4
	428 i xDrive	05.14→	180		0 204 781 585	25,4
	430 d	06.14→	190-210	LLE	0 204 781 585	25,4
				RLE	0 204 781 589	25,4
	435 d xDrive	06.14→	230	LLE	0 204 781 585	25,4
				RLE	0 204 781 589	25,4
	435 i	05.14→	225	LLE	0 204 781 585	25,4
				RLE	0 204 781 589	25,4
	435 i xDrive	06.14→	225		0 204 781 585	25,4
	418 d, i	05.14→	100/105/110		0 986 486 065	19,05
	420 d, d xDrive, i, i xDrive	05.14→	135/140		0 986 486 065	19,05
	428 i, i xDrive	05.14→	180		0 986 486 065	19,05
	435 i, i xDrive	05.14→	225		0 986 486 065	19,05

Serie 5 [E 34]



	M 5 3.6, 3.8	11.90-12.95	232/240-250	JBH	0 986 480 598	25,4
	518 i	09.90-12.95	85	JBH GIR	0 986 480 603	20,6
		10.91-12.94	83	JBH	0 986 480 603	20,6
	520 i	10.91-12.95	110	JBH	0 986 480 603	20,6
	525 i	10.91-12.95	141	JBH	0 986 480 603	20,6
		03.94-12.96	141	JBH GIR	0 986 480 603	20,6
	525 ix	10.91-12.95	141	JBH	0 986 480 603	20,6
	525 td	03.93-12.95	85	JBH GIR	0 986 480 603	20,6
	525 tds	10.91-12.95	105	JBH	0 986 480 603	20,6
	530 i	10.93-12.95	160	JBH, LLE	0 986 480 603	20,6
	540 i	10.93-09.95	210	JBH, LLE	0 986 480 603	20,6





	518 i	09.89-12.95	83/85		0 986 486 028	19,05	
	520 i	09.89-12.95	110		0 986 486 028	19,05	
	525 i, ix, td, tds	09.89-12.95	85/105/141		0 986 486 028	19,05	
	530 i	09.92-12.95	160		0 986 486 028	19,05	
	540 i	09.92-09.95	210		0 986 486 028	19,05	
	518 i	10.90-12.95	83/85		0 986 486 534	22,2	
	520 i	12.90-12.95	110		0 986 486 534	22,2	
	525 i, ix, td, tds	10.90-12.95	85/105/141		0 986 486 534	22,2	
	530 i	09.92-12.95	160		0 986 486 534	22,2	
	518 i	06.94-12.95	85		0 265 213 011^H		
	520 i	06.94-12.95	110		0 265 213 011^H		
	525 i	10.93-12.96	141		0 265 213 011^H		
					0 265 217 002^J		
	525 ix	10.93-12.95	141		0 265 217 002^J		
	525 td, tds	06.94-12.95	85/105		0 265 213 011^H		
	530 i	10.93-12.95	160		0 265 213 011^H		
					0 265 217 002^J		
	540 i	10.93-09.95	210		0 265 217 002^J		
		10.93-12.96	210		0 265 213 011^H		
	M 5 3.6	11.90-12.94	232		0 265 100 049^H		
	M 5 3.8	03.92-12.95	240-250		0 265 100 055^H		
	518 i		10.91-05.94	85		0 265 103 047^H	
			10.91-12.94	83		0 265 103 047^H	
			06.94-12.95	85		0 265 108 006^H	
			10.91-05.94	110		0 265 103 047^H	
	520 i		06.94-12.95	110		0 265 108 006^H	
			10.91-05.94	110		0 265 103 047^H	
	525 i		10.91-05.94	141		0 265 103 047^H	
			10.93-12.96	141	THE	0 265 109 010^J	
			06.94-12.96	141		0 265 108 006^H	
	525 ix	10.93-12.95	141		0 265 109 011^J		
	525 td	09.91-05.94	85/105		0 265 103 047^H		
	525 tds	06.94-12.95	85/105		0 265 108 006^H		
	530 i		10.93-12.95	160		0 265 108 006^H	
					THE	0 265 109 010^J	
	535 i	01.89-12.94	155		0 265 100 049^H		
540 i		10.93-09.95	210	THE	0 265 109 010^J		
		10.93-12.96	210		0 265 108 006^H		

Serie 5 [E 39]

	M 5	10.98-07.03	294		JBH	0 986 480 976	25,4	
	520 d	04.00-07.03	100		JBH	0 986 480 925	25,4	
	520 i		09.95-09.97	100-110		LLE	0 986 480 604	20,6
						JBH,RLE	0 986 480 605	20,6
			MFD 10.97-07.03	100-110/120-125		JBH	0 986 480 976	25,4
			OFD 10.97-07.03	100-110/120-125		JBH	0 986 480 925	25,4
			09.95-09.97	125		LLE	0 986 480 604	20,6
						JBH,RLE	0 986 480 605	20,6
	523 i		09.98-08.00	125		JBH	0 986 480 925	25,4
			MFD 10.97-12.02	125/135		JBH	0 986 480 976	25,4
			OFD 10.97-09.00	125		JBH	0 986 480 925	25,4
			03.99-12.02	135		JBH	0 986 480 925	25,4
		525 d	MFD 04.00-07.03	120/141		JBH	0 986 480 976	25,4
		525 i	OFD 04.00-07.03	120/141		JBH	0 986 480 925	25,4
	525 td		01.97-09.97	85			0 986 480 604	20,6
			10.97-09.00	85		JBH	0 986 480 925	25,4
	525 tds		01.96-09.97	105		LLE	0 986 480 604	20,6
						JBH,RLE	0 986 480 605	20,6



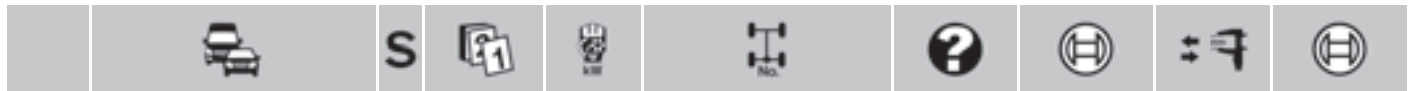













BMW Serie 5 [E 39]

525 tds	10.97-09.00	105		JBH	0986 480 925	25,4
528 i	09.95-09.97	142		LLE	0986 480 604	20,6
				JBH,RLE	0986 480 605	20,6
	MFD 10.97-09.00	142		JBH	0986 480 976	25,4
	OFD 10.97-09.00	142		JBH	0986 480 925	25,4
530 d	MFD 08.98-07.03	135-142/170		JBH	0986 480 976	25,4
530 i	OFD 08.98-07.03	135-142/170		JBH	0986 480 925	25,4
535 i	01.96-09.97	173-180		LLE	0986 480 604	20,6
				JBH,RLE	0986 480 605	20,6
	MFD 10.97-07.03	173-180		JBH	0986 480 976	25,4
	OFD 10.97-07.03	173-180		JBH	0986 480 925	25,4
540 i	01.96-09.97	210		LLE	0986 480 604	20,6
				JBH	0986 480 605	20,6
				JBH,RLE	0986 480 605	20,6
	10.97-09.98	210		JBH	0986 480 925	25,4
	MFD 10.97-07.03	210		JBH	0986 480 976	25,4
	OFD 10.97-07.03	210		JBH	0986 480 925	25,4

M 5	10.98-09.01	294			0986 486 049	19,05
	10.01-07.03	294			0986 486 065	19,05
520 d	04.00-09.01	100			0986 486 049	19,05
	10.01-07.03	100			0986 486 065	19,05
520 i	09.95-09.97	100-110		LLE	0986 486 039	19,05
	10.97-09.01	100-110			0986 486 049	19,05
	09.00-09.01	120-125			0986 486 049	19,05
	10.01-06.03	100-110			0986 486 065	19,05
	10.01-07.03	120-125			0986 486 065	19,05
523 i	09.95-09.97	125		LLE	0986 486 039	19,05
	10.97-09.00	125			0986 486 049	19,05
525 d	04.00-09.01	120/141			0986 486 049	19,05
525 i	10.01-07.03	120/141			0986 486 065	19,05
525 td	01.97-09.97	85			0986 486 039	19,05
	10.97-09.00	85			0986 486 049	19,05
525 tds	01.96-09.97	105		LLE	0986 486 039	19,05
	10.97-09.00	105			0986 486 049	19,05
528 i	09.95-09.97	142		LLE	0986 486 039	19,05
	10.97-09.00	142			0986 486 049	19,05
530 d	08.98-09.01	135-142/170			0986 486 049	19,05
530 i	10.01-07.03	135-142/170			0986 486 065	19,05
535 i	01.96-06.96	173-180		LLE	0986 486 039	19,05
	10.97-09.01	173-180			0986 486 049	19,05
	10.01-07.03	173-180			0986 486 065	19,05
540 i	01.96-06.96	210		LLE	0986 486 039	19,05
	10.97-09.01	210			0986 486 049	19,05
	10.01-07.03	210			0986 486 065	19,05

520 d	04.00-07.03	100			0986 486 534	22,2
520 i	09.95-09.97	100-110			0986 486 534	22,2
	10.97-06.03	100-110		LLE	0986 486 534	22,2
				RLE	F 026 A06 931	
	09.00-07.03	120-125		LLE	0986 486 534	22,2
523 i	09.95-09.97	125			0986 486 534	22,2
	10.97-09.00	125		LLE	0986 486 534	22,2
				RLE	F 026 A06 931	
525 d	04.00-07.03	120/141		LLE	0986 486 534	22,2
525 i				RLE	F 026 A06 931	
525 td	01.97-09.00	85			0986 486 534	22,2
525 tds	01.96-09.97	105			0986 486 534	22,2
	10.97-09.00	105		LLE	0986 486 534	22,2
				RLE	F 026 A06 931	
528 i	09.95-09.97	142			0986 486 534	22,2

		S							
528i		10.97-09.00	142			LLE	0 986 486 534	22,2	
						RLE	F 026 A06 931		
530d		08.98-07.03	135-142/			LLE	0 986 486 534	22,2	
530i			170			RLE	F 026 A06 931		
535i		01.96-06.96	173-180			RLE	0 986 486 534	22,2	
		01.96-07.03	173-180			LLE	0 986 486 534	22,2	
		07.96-07.03	173-180			RLE	F 026 A06 931		
540i		07.96-07.03	210			LLE	0 986 486 534	22,2	
						RLE	F 026 A06 931		
 M 5		10.98-07.03	294			GRG	0 265 225 006 ^T		
520d		04.00-07.03	100			GRG	0 265 223 002 ^F		
520i		09.95-09.98	100-110				0 265 217 002 ^J		
		10.98-06.03	100-110			GRG	0 265 223 002 ^F		
							0 265 225 006 ^T		
		09.00-07.03	120-125			GRG	0 265 223 002 ^F		
							0 265 225 006 ^T		
523i		09.95-09.98	125				0 265 217 002 ^J		
		10.98-09.00	125			GRG	0 265 223 002 ^F		
							0 265 225 006 ^T		
		03.99-12.02	135			GRG	0 265 223 002 ^F		
							0 265 225 006 ^T		
525d		04.00-07.03	120/141			GRG	0 265 223 002 ^F		
525i							0 265 225 006 ^T		
525td		01.96-09.98	85/105				0 265 217 002 ^J		
525tds		10.98-09.00	85/105			GRG	0 265 223 002 ^F		
528i		09.95-09.98	142				0 265 217 002 ^J		
		10.98-09.00	142			GRG	0 265 223 002 ^F		
							0 265 225 006 ^T		
530d		08.98-07.03	135-142/170			GRG	0 265 223 002 ^F		
530i		10.98-07.03	135-142/170			GRG	0 265 225 006 ^T		
535i		01.96-09.98	173-180				0 265 217 002 ^J		
		10.98-07.03	173-180			GRG	0 265 225 006 ^T		
540i		01.96-09.98	210				0 265 202 411 ^M		
							0 265 217 002 ^J		
		10.98-07.03	210			GRG	0 265 225 006 ^T		
 CPU		09.95-09.98	100-110				0 265 109 023 ^J		
523i		09.95-09.98	125				0 265 109 023 ^J		
525td, tds		01.96-09.98	85/105			THE	0 265 109 016 ^J		
528i		09.95-09.98	142				0 265 109 023 ^J		
535i		01.96-09.98	173-180				0 265 109 077 ^J		
540i		01.96-09.98	210				0 265 109 077 ^J		
						GRA	0 265 109 411 ^M		
 M 5		10.98-07.03	294				0 265 005 248		
520i		10.98-07.03	100-110/120-125				0 265 005 248		
523i		10.98-12.02	125/135				0 265 005 248		
525d, i		04.00-07.03	120/141				0 265 005 248		
528i		10.98-09.00	142				0 265 005 248		
530d, i		10.98-07.03	135-142/170				0 265 005 248		
535i		10.98-07.03	173-180				0 265 005 248		
540i		10.98-07.03	210				0 265 005 248		
 M 5		10.98-07.03	294				0 265 005 303		
520i		10.98-07.03	100-110/120-125				0 265 005 303		
523i		10.98-12.02	125/135				0 265 005 303		
525d, i		04.00-07.03	120/141				0 265 005 303		
528i		10.98-09.00	142				0 265 005 303		
530d, i		10.98-07.03	135-142/170				0 265 005 303		
535i		10.98-07.03	173-180				0 265 005 303		
540i		10.98-07.03	210				0 265 005 303		





◀ BMW









Serie 5 [E 60]



	M 5	11.04-12.09	373	JBH	0986 481 012	
	520 d, i	09.05-02.10	110/120-130	JBH	0986 481 012	
	523 i	03.05-02.10	130/140	JBH	0986 481 012	
	525 d, d xDrive, i, i xDrive, Li, xd, xi	05.04-05.10	120/130/145/160	JBH	0986 481 012	
	528 i	03.07-02.10	172	JBH	0986 481 012	
	530 d, d xDrive, i, i xDrive, xd, xi	07.03-02.10	160/170/173/190-200	JBH	0986 481 012	
	535 d	09.04-02.10	200/210	JBH	0986 481 012	
	540 i	09.05-02.10	225	JBH	0986 481 012	
	545 i	09.03-09.05	245	JBH	0986 481 012	
	550 i	09.05-02.10	270	JBH	0986 481 012	

	520 d	09.05-09.07	110		0986 486 534	22,2
		09.05-02.08	120		0986 486 534	22,2
	520 d	09.07-05.08	120-130		0986 486 534	22,2
	520 i	06.08-02.10	120-130		0986 486 607	22,2
	520 i	07.03-03.05	125		0986 486 534	22,2
		09.07-05.08	115		0986 486 534	22,2
		06.08-02.10	115		0986 486 607	22,2
	523 i	03.05-05.08	130/140		0986 486 534	22,2
		06.08-02.10	130/140		0986 486 607	22,2
	525 d, d xDrive, xd	06.08-02.10	145		0986 486 607	22,2
	525 d, i	09.03-03.07	120/130/141		0986 486 534	22,2
	525 d, xd	03.07-05.08	145		0986 486 534	22,2
	525 i	03.05-05.08	160		0986 486 534	22,2
	525 i, i xDrive, xi	06.08-02.10	160		0986 486 607	22,2
	525 Li	08.05-05.10	160		0986 486 534	22,2
	525 xi	03.05-05.08	160		0986 486 534	22,2
	528 i	03.07-05.08	172		0986 486 534	22,2
		06.08-02.10	172		0986 486 607	22,2
	530 d, d xDrive, xd	06.08-02.10	173		0986 486 607	22,2
	530 d, i, xd	07.03-03.07	160/170		0986 486 534	22,2
	530 d, xd	03.07-05.08	173		0986 486 534	22,2
	530 i xDrive, xi	06.08-02.10	190		0986 486 607	22,2
	530 i, i xDrive, xi	06.08-02.10	190-200		0986 486 607	22,2
	530 i, xi	03.05-05.08	190-200		0986 486 534	22,2
	530 xi	03.05-05.08	190		0986 486 534	22,2
		09.05-05.08	225		0986 486 534	22,2
	540 i	06.08-02.10	225		0986 486 607	22,2
		09.03-09.05	245		0986 486 534	22,2
	550 i	09.05-05.08	270		0986 486 534	22,2
		06.08-02.10	270		0986 486 607	22,2

	520 d	09.05-02.08	110/120	EAL	0 265 236 023 ^T	
				EAL	0 265 236 021 ^T	
	520 i	07.03-03.05	125	EAL	0 265 234 137 ^T	
				EAL	0 265 234 135 ^T	
	523 i	03.05-09.05	130	EAL	0 265 234 137 ^T	
				EAL	0 265 234 135 ^T	
				10.05-03.07	130	EAL
	525 d	05.04-09.05	120/130	EAL	0 265 234 137 ^T	
				EAL	0 265 234 135 ^T	
				10.05-03.07	120/130	EAL
	525 i	09.03-03.05	141	EAL	0 265 234 137 ^T	
				EAL	0 265 234 135 ^T	
				03.05-09.05	160	EAL
				EAL	0 265 234 135 ^T	

		S							
525 i							EAL		0 265 236 023 ^T
							EAL		0 265 236 021 ^T
525 Li							EAL		0 265 236 023 ^T
							EAL		0 265 236 021 ^T
525 xi									0 265 236 025 ^T
530 d							EAL		0 265 234 137 ^T
							EAL		0 265 234 135 ^T
							EAL		0 265 236 023 ^T
							EAL		0 265 236 021 ^T
530 i							EAL		0 265 234 137 ^T
							EAL		0 265 234 135 ^T
							EAL		0 265 234 137 ^T
							EAL		0 265 234 135 ^T
							EAL		0 265 236 023 ^T
							EAL		0 265 236 021 ^T
530 xd									0 265 236 025 ^T
530 xi									0 265 236 025 ^T
535 d							EAL		0 265 234 137 ^T
							EAL		0 265 234 135 ^T
							EAL		0 265 236 023 ^T
							EAL		0 265 236 021 ^T
540 i							EAL		0 265 236 023 ^T
							EAL		0 265 236 021 ^T
545 i							EAL		0 265 234 137 ^T
							EAL		0 265 234 135 ^T
550 i							EAL		0 265 236 023 ^T
							EAL		0 265 236 021 ^T
 520 d									0 265 005 711
520 i							EAL		0 265 005 712
							EAL		0 265 005 711
520 i									0 265 005 266
							AFP,EAL		0 265 005 285
523 i									0 265 005 266
							AFP,EAL		0 265 005 285
							EAL		0 265 005 712
							EAL		0 265 005 711
							EAL		0 265 005 712
							EAL		0 265 005 711
525 d									0 265 005 266
							AFP,EAL		0 265 005 285
							EAL		0 265 005 712
							EAL		0 265 005 711
							EAL		0 265 005 712
							EAL		0 265 005 711
525 d xDrive, xd									0 265 005 711
525 i									0 265 005 266
							AFP,EAL		0 265 005 285
									0 265 005 266
							AFP,EAL		0 265 005 285
							EAL		0 265 005 711
525 i xDrive									0 265 005 711
525 i, Li							EAL		0 265 005 712
525 Li							EAL		0 265 005 711
525 xi									0 265 005 711
528 i									0 265 005 711
530 d									0 265 005 266
							AFP,EAL		0 265 005 285
							EAL		0 265 005 712
							EAL		0 265 005 711
							EAL		0 265 005 712
							EAL		0 265 005 711
530 d xDrive, xd									0 265 005 711





◀ BMW Serie 5 [E 60]

530 i	07.03-03.05	170		0 265 005 266	
			AFP,EAL	0 265 005 285	
	03.05-09.05	190-200		0 265 005 285	
			EAL,TW	0 265 005 266	
	10.05-02.10	190-200		0 265 005 712	
			EAL	0 265 005 711	
	03.07-02.10	200		0 265 005 712	
			EAL	0 265 005 711	
530 i xDrive	10.05-02.10	190		0 265 005 711	
530 xi	03.07-02.10	200		0 265 005 711	
530 xd	09.05-03.07	170		0 265 005 711	
535 d	09.04-09.05	200		0 265 005 266	
			AFP,EAL	0 265 005 285	
	10.05-03.07	200		0 265 005 712	
			EAL	0 265 005 711	
	03.07-02.10	210		0 265 005 712	
			EAL	0 265 005 711	
540 i	09.05-02.10	225		0 265 005 712	
			EAL	0 265 005 711	
545 i	09.03-09.05	245		0 265 005 266	
			AFP,EAL	0 265 005 285	
550 i	09.05-02.10	270		0 265 005 712	
			EAL	0 265 005 711	

Serie 5 [F 10]













	518 d	07.13→	105/110		0 986 486 607	22,2
	520 d, d ed, i	05.10→	135/140		0 986 486 607	22,2
	523 i	03.10-08.11	150		0 986 486 607	22,2
	525 d, d xDrive	03.10→	150/160		0 986 486 607	22,2
	528 i	03.10→	180/190		0 986 486 607	22,2
	530 d, d xDrive, i	03.10→	180/190-210		0 986 486 607	22,2
	535 i, i xDrive	03.10→	225		0 986 486 607	22,2
	550 i xDrive	07.13→	330		0 986 486 607	22,2

Serie 5 GT [F 07]

	520 d	07.12→	135	JBH	0 986 481 012	
	528 i GT	07.13→	180	JBH	0 986 481 012	
	530 d, d xDrive	10.09→	155/180/190	JBH	0 986 481 012	
	535 d, d xDrive, i, i xDrive	10.09→	220/225/230	JBH	0 986 481 012	
	550 i, i xDrive	10.09→	300/330	JBH	0 986 481 012	

Serie 5 Touring [E 34]

	M 5	04.92-12.95	240-250	JBH	0 986 480 598	25,4
	518 g	11.95-06.96	75-85	JBH GIR	0 986 480 603	20,6
	518 i	03.93-12.94	83-85	JBH	0 986 480 603	20,6
		09.94-12.96	85	JBH GIR	0 986 480 603	20,6
	520 i	11.91-12.96	110	JBH	0 986 480 603	20,6
		525 i, ix, tds	11.91-12.96	105/141	JBH	0 986 480 603
	525 td	03.93-12.96	85	JBH GIR	0 986 480 603	20,6
		530 i	10.93-12.96	160	JBH,LLE	0 986 480 603
	540 i	10.93-12.96	210	JBH,LLE	0 986 480 603	20,6
		518 g, i	03.93-12.96	75-85		0 986 486 028
	520 i	11.91-12.96	110		0 986 486 028	19,05
		525 i, ix, td, tds	11.91-12.96	85/105/141		0 986 486 028















		S							
	530 i	09.92-12.96	160				0 986 486 028		19,05
	540 i	10.93-12.96	210				0 986 486 028		19,05
	518 g, i	03.93-12.96	75-85				0 986 486 534		22,2
	520 i	11.91-12.96	110				0 986 486 534		22,2
	525 i, ix, td, tds	11.91-12.96	85/105/141				0 986 486 534		22,2
	530 i	09.92-12.96	160				0 986 486 534		22,2
	518 g, i	09.94-12.96	75-85				0 265 213 011 ^H		
	520 i	06.94-12.96	110				0 265 213 011 ^H		
	525 i	10.93-12.96	141				0 265 217 002 ^J		
		06.94-12.96	141				0 265 213 011 ^H		
	525 ix	10.93-12.96	141				0 265 217 002 ^J		
	525 td, tds	06.94-12.96	85/105				0 265 213 011 ^H		
	530 i	10.93-12.96	160				0 265 213 011 ^H		
							0 265 217 002 ^J		
	540 i	10.93-12.96	210				0 265 213 011 ^H		
							0 265 217 002 ^J		
	M 5	04.92-12.95	240-250				0 265 100 055 ^H		
	518 g	11.95-06.96	75-85				0 265 108 006 ^H		
	518 i	03.93-12.94	83-85				0 265 103 047 ^H		
		09.94-12.96	85				0 265 108 006 ^H		
	520 i	11.91-05.94	110				0 265 103 047 ^H		
		06.94-12.96	110				0 265 108 006 ^H		
	525 i	11.91-05.94	141				0 265 103 047 ^H		
		10.93-12.96	141		THE		0 265 109 010 ^J		
		06.94-12.96	141				0 265 108 006 ^H		
	525 ix	10.93-12.96	141				0 265 109 011 ^J		
	525 td	12.91-05.94	85/105				0 265 103 047 ^H		
	525 tds	06.94-12.96	85/105				0 265 108 006 ^H		
	530 i	10.93-12.96	160				0 265 108 006 ^H		
					THE		0 265 109 010 ^J		
	540 i	10.93-12.96	210				0 265 108 006 ^H		
					THE		0 265 109 010 ^J		
Serie 5 Touring [E 39]									
									
	520 d	04.00-07.03	100			JBH	0 986 480 925		25,4
	520 i	12.96-09.97	100-110			LLE	0 986 480 604		20,6
						JBH,RLE	0 986 480 605		20,6
		MFD 10.97-05.04	100-110/120-125			JBH	0 986 480 976		25,4
		OFD 10.97-05.04	100-110/120-125			JBH	0 986 480 925		25,4
	523 i	01.97-09.97	125			LLE	0 986 480 604		20,6
						JBH,RLE	0 986 480 605		20,6
		MFD 10.97-09.00	125			JBH	0 986 480 976		25,4
		OFD 10.97-09.00	125			JBH	0 986 480 925		25,4
	525 d	MFD 04.00-05.04	120/141			JBH	0 986 480 976		25,4
	525 i	OFD 04.00-05.04	120/141			JBH	0 986 480 925		25,4
	525 tds	03.97-09.97	105			LLE	0 986 480 604		20,6
						JBH,RLE	0 986 480 605		20,6
		10.97-09.00	105			JBH	0 986 480 925		25,4
	528 i	01.97-09.97	142			LLE	0 986 480 604		20,6
						JBH,RLE	0 986 480 605		20,6
		MFD 10.97-09.00	142			JBH	0 986 480 976		25,4
		OFD 10.97-09.00	142			JBH	0 986 480 925		25,4
	530 d	MFD 08.98-05.04	135-142/170			JBH	0 986 480 976		25,4
	530 i	OFD 08.98-05.04	135-142/170			JBH	0 986 480 925		25,4
	540 i	03.97-09.97	210			LLE	0 986 480 604		20,6
						JBH,RLE	0 986 480 605		20,6
		MFD 10.97-05.04	210			JBH	0 986 480 976		25,4
		OFD 10.97-05.04	210			JBH	0 986 480 925		25,4





◀ BMW Serie 5 Touring [E 39]















	520 d	04.00-09.01	100		0 986 486 049	19,05
		10.01-07.03	100		0 986 486 065	19,05
	520 i	12.96-09.97	100-110	LLE	0 986 486 039	19,05
		10.97-09.01	100-110		0 986 486 049	19,05
		09.00-09.01	120-125		0 986 486 049	19,05
		10.01-12.01	100-110		0 986 486 065	19,05
		10.01-05.04	120-125		0 986 486 065	19,05
		01.97-09.97	125	LLE	0 986 486 039	19,05
	523 i	10.97-09.00	125		0 986 486 049	19,05
		04.00-09.01	120/141		0 986 486 049	19,05
	525 i	10.01-05.04	120/141		0 986 486 065	19,05
	525 tds	03.97-09.97	105	LLE	0 986 486 039	19,05
		10.97-09.00	105		0 986 486 049	19,05
	528 i	01.97-09.97	142	LLE	0 986 486 039	19,05
		10.97-09.00	142		0 986 486 049	19,05
	530 d	08.98-09.01	135-142/170		0 986 486 049	19,05
	530 i	10.01-05.04	135-142/170		0 986 486 065	19,05
	540 i	10.97-09.01	210		0 986 486 049	19,05
		10.01-05.04	210		0 986 486 065	19,05
	520 d	04.00-07.03	100		0 986 486 534	22,2
		12.96-09.97	100-110		0 986 486 534	22,2
	520 i	10.97-12.01	100-110	LLE	0 986 486 534	22,2
				RLE	F 026 A06 931	
		09.00-05.04	120-125	LLE	0 986 486 534	22,2
				RLE	F 026 A06 931	
		01.97-09.97	125		0 986 486 534	22,2
		10.97-09.00	125	LLE	0 986 486 534	22,2
	523 i			RLE	F 026 A06 931	
		04.00-05.04	120/141	LLE	0 986 486 534	22,2
	525 i			RLE	F 026 A06 931	
	525 tds	03.97-09.97	105		0 986 486 534	22,2
		10.97-09.00	105	LLE	0 986 486 534	22,2
	528 i			RLE	F 026 A06 931	
		01.97-09.97	142		0 986 486 534	22,2
		10.97-09.00	142	LLE	0 986 486 534	22,2
				RLE	F 026 A06 931	
	530 d	08.98-05.04	135-142/	LLE	0 986 486 534	22,2
	530 i		170	RLE	F 026 A06 931	
	540 i	03.97-05.04	210	LLE	0 986 486 534	22,2
				RLE	F 026 A06 931	
	520 d	04.00-07.03	100	GRG	0 265 223 002 ^F	
		12.96-09.98	100-110		0 265 217 002 ^J	
	520 i	10.98-12.01	100-110	GRG	0 265 223 002 ^F	
					0 265 225 006 ^T	
		09.00-05.04	120-125	GRG	0 265 223 002 ^F	
					0 265 225 006 ^T	
		01.97-09.98	125		0 265 217 002 ^J	
		10.98-09.00	125	GRG	0 265 223 002 ^F	
	523 i				0 265 225 006 ^T	
		04.00-05.04	120/141	GRG	0 265 223 002 ^F	
	525 i				0 265 225 006 ^T	
	525 tds	03.97-09.98	105		0 265 217 002 ^J	
		10.98-09.00	105	GRG	0 265 223 002 ^F	
	528 i	01.97-09.98	142		0 265 217 002 ^J	
		10.98-09.00	142	GRG	0 265 223 002 ^F	
					0 265 225 006 ^T	
	530 d	08.98-05.04	135-142/170	GRG	0 265 223 002 ^F	
	530 i	10.98-05.04	135-142/170	GRG	0 265 225 006 ^T	
	540 i	03.97-09.98	210		0 265 202 411 ^M	
					0 265 217 002 ^J	

		S							
	540 i	10.98-05.04	210			GRG	0 265 225 006 ^T		
	520 i	12.96-09.98	100-110				0 265 109 023 ^J		
	523 i	01.97-09.98	125				0 265 109 023 ^J		
	525 tds	03.97-09.98	105			THE	0 265 109 016 ^J		
	528 i	01.97-09.98	142				0 265 109 023 ^J		
	540 i	03.97-09.98	210			GRA	0 265 109 077 ^J		
							0 265 109 411 ^M		
	520 i	10.98-05.04	100-110/120-125				0 265 005 248		
	523 i	10.98-09.00	125				0 265 005 248		
	525 d, i	04.00-05.04	120/141				0 265 005 248		
	528 i	10.98-09.00	142				0 265 005 248		
	530 d, i	10.98-05.04	135-142/170				0 265 005 248		
	540 i	10.98-05.04	210				0 265 005 248		
	520 i	10.98-05.04	100-110/120-125				0 265 005 303		
	523 i	10.98-09.00	125				0 265 005 303		
	525 d, i	04.00-05.04	120/141				0 265 005 303		
	528 i	10.98-09.00	142				0 265 005 303		
	530 d, i	10.98-05.04	135-142/170				0 265 005 303		
	540 i	10.98-05.04	210				0 265 005 303		
Serie 5 Touring [E 61]									
									
	M 5	03.07-08.10	373			JBH	0 986 481 012		
	520 d, i	09.05-08.10	110/120-130			JBH	0 986 481 012		
	523 i	03.07-08.10	140			JBH	0 986 481 012		
		04.07-08.10	130			JBH	0 986 481 012		
	525 d, d xDrive, xd	05.04-08.10	120/130/145			JBH	0 986 481 012		
	525 i	03.07-08.10	160			JBH	0 986 481 012		
	525 i xDrive, xi	03.05-08.10	160			JBH	0 986 481 012		
	530 d, d xDrive, i xDrive, xd	05.04-08.10	160/170/173/190			JBH	0 986 481 012		
	530 i	04.07-03.10	190-200			JBH	0 986 481 012		
	530 i, i xDrive, xi	03.07-08.10	200			JBH	0 986 481 012		
	530 xi	03.05-08.08	190-200			JBH	0 986 481 012		
	535 d	09.04-08.10	200/210			JBH	0 986 481 012		
	545 i	05.04-09.05	245			JBH	0 986 481 012		
	550 i	09.05-08.10	270			JBH	0 986 481 012		
		520 d	09.05-02.08	110/120				0 986 486 534	22,2
520 d		09.07-05.08	120-130				0 986 486 534	22,2	
520 i		06.08-08.10	120-130				0 986 486 607	22,2	
523 i		03.05-05.08	130/140				0 986 486 534	22,2	
		06.08-08.10	130/140				0 986 486 607	22,2	
525 d, d xDrive, i, i xDrive, xd, xi		06.08-08.10	145/160				0 986 486 607	22,2	
525 d, i		05.04-03.07	120/141				0 986 486 534	22,2	
525 d, i, xd, xi		03.05-05.08	145/160				0 986 486 534	22,2	
530 d, d xDrive, xd		06.08-08.10	173				0 986 486 607	22,2	
530 d		05.04-03.07	160/170				0 986 486 534	22,2	
530 xd		03.07-05.08	173				0 986 486 534	22,2	
530 i xDrive		09.08-03.10	190				0 986 486 607	22,2	
530 i, i xDrive, xi		06.08-08.10	190-200				0 986 486 607	22,2	
530 i, xi		03.05-05.08	190-200				0 986 486 534	22,2	
545 i		05.04-09.05	245				0 986 486 534	22,2	
550 i		09.05-05.08	270				0 986 486 534	22,2	
		06.08-08.10	270				0 986 486 607	22,2	
		520 d	09.05-02.08	110/120			EAL	0 265 236 023 ^T	
						EAL	0 265 236 021 ^T		





Model	Period	Power	Region	Part Number
BMW Serie 5 Touring [E 61]				
523 i	03.05-09.05	130	EAL	0 265 234 137 ^T
			EAL	0 265 234 135 ^T
	10.05-03.07	130	EAL	0 265 236 023 ^T
			EAL	0 265 236 021 ^T
525 d	05.04-09.05	120/130	EAL	0 265 234 137 ^T
			EAL	0 265 234 135 ^T
	10.05-03.07	120/130	EAL	0 265 236 023 ^T
			EAL	0 265 236 021 ^T
525 i	05.04-03.05	141	EAL	0 265 234 137 ^T
			EAL	0 265 234 135 ^T
	03.05-09.05	160	EAL	0 265 234 137 ^T
EAL			0 265 234 135 ^T	
	10.05-03.07	160	EAL	0 265 236 023 ^T
			EAL	0 265 236 021 ^T
525 xi	03.05-03.07	160		0 265 236 025 ^T
530 d	05.04-09.05	160	EAL	0 265 234 137 ^T
			EAL	0 265 234 135 ^T
	09.05-03.07	170	EAL	0 265 236 023 ^T
			EAL	0 265 236 021 ^T
530 i	03.05-09.05	190-200	EAL	0 265 234 137 ^T
			EAL	0 265 234 135 ^T
	10.05-03.07	190-200	EAL	0 265 236 023 ^T
			EAL	0 265 236 021 ^T
530 xd	09.05-03.07	170		0 265 236 025 ^T
530 xi	03.05-03.07	190-200		0 265 236 025 ^T
535 d	09.04-09.05	200	EAL	0 265 234 137 ^T
			EAL	0 265 234 135 ^T
	10.05-03.07	200	EAL	0 265 236 023 ^T
			EAL	0 265 236 021 ^T
545 i	05.04-09.05	245	EAL	0 265 234 137 ^T
			EAL	0 265 234 135 ^T
550 i	09.05-03.07	270	EAL	0 265 236 023 ^T
			EAL	0 265 236 021 ^T
520 d	09.05-02.08	110/120		0 265 005 711
				0 265 005 712
520 d	09.07-08.10	120-130	EAL	0 265 005 711
520 i	03.05-09.05	130	AFP,EAL,TW	0 265 005 285
			EAL,TW	0 265 005 266
	10.05-08.10	130	EAL	0 265 005 712
			EAL	0 265 005 711
	03.07-08.10	140	EAL	0 265 005 712
			EAL	0 265 005 711
525 d	05.04-09.05	120/130		0 265 005 266
			AFP,EAL	0 265 005 285
	10.05-03.07	120/130	EAL	0 265 005 712
			EAL	0 265 005 711
	03.07-08.10	145	EAL	0 265 005 712
			EAL	0 265 005 711
525 d xDrive, xd	09.07-08.10	145		0 265 005 711
525 i	05.04-03.05	141		0 265 005 266
			AFP,EAL	0 265 005 285
	03.05-09.05	160		0 265 005 266
			AFP,EAL	0 265 005 285
	10.05-08.10	160	EAL	0 265 005 712
			EAL	0 265 005 711
525 i xDrive, xi	10.05-08.10	160		0 265 005 711
530 d	05.04-09.05	160		0 265 005 266
			AFP,EAL	0 265 005 285
	09.05-08.10	170/173	EAL	0 265 005 712
			EAL	0 265 005 711
530 d xDrive, xd	09.05-08.10	170/173		0 265 005 711

		S							
530 i		03.05-09.05	190-200				0 265 005 266		
						AFP,EAL	0 265 005 285		
		10.05-03.10	190-200			EAL	0 265 005 712		
						EAL	0 265 005 711		
		03.07-08.10	200			EAL	0 265 005 712		
						EAL	0 265 005 711		
530 i xDrive		09.08-03.10	190				0 265 005 711		
530 i xDrive, xi		03.07-08.10	200				0 265 005 711		
530 xi		10.05-08.08	190-200				0 265 005 711		
535 d		09.04-09.05	200				0 265 005 266		
						AFP,EAL	0 265 005 285		
		10.05-03.07	200			EAL	0 265 005 712		
						EAL	0 265 005 711		
		03.07-08.10	210			EAL	0 265 005 712		
						EAL	0 265 005 711		
545 i		05.04-09.05	245				0 265 005 266		
						AFP,EAL	0 265 005 285		
550 i		09.05-08.10	270			EAL	0 265 005 712		
						EAL	0 265 005 711		
Serie 5 Touring [F 11]									
									
	518 d	07.13→	105/110				0 986 486 607	22,2	
	520 d, i	09.10→	135/140				0 986 486 607	22,2	
	523 i	09.10-08.11	150				0 986 486 607	22,2	
	525 d, d xDrive	09.10→	150/160				0 986 486 607	22,2	
	528 i, i xDrive	09.10→	180/190-200				0 986 486 607	22,2	
	530 d, d xDrive, i	09.10→	180/190-210				0 986 486 607	22,2	
	535 i, i xDrive	09.10→	225				0 986 486 607	22,2	
Serie 6 Cabrio [E 64]									
									
	M 6	11.06-07.10	373			JBH	0 986 481 012		
	630 i	09.04-07.10	190/200			JBH	0 986 481 012		
	635 d	09.07-07.10	210			JBH	0 986 481 012		
	645 i	04.04-09.05	245			JBH	0 986 481 012		
	650 i	09.05-07.10	270			JBH	0 986 481 012		
	630 i	09.04-05.08	190/200				0 986 486 534	22,2	
		06.08-07.10	190/200				0 986 486 607	22,2	
	645 i	04.04-09.05	245				0 986 486 534	22,2	
	650 i	09.05-05.08	270				0 986 486 534	22,2	
		06.08-07.10	270				0 986 486 607	22,2	
	630 i	09.04-09.05	190			EAL	0 265 234 137 ^T		
						EAL	0 265 234 135 ^T		
		10.05-08.07	190			EAL	0 265 236 023 ^T		
						EAL	0 265 236 021 ^T		
	645 i	04.04-09.05	245			EAL	0 265 234 137 ^T		
						EAL	0 265 234 135 ^T		
	650 i	09.05-08.07	270			EAL	0 265 236 023 ^T		
						EAL	0 265 236 021 ^T		
	630 i	09.04-09.05	190				0 265 005 266		
						AFP,EAL	0 265 005 285		
		10.05-07.10	190			EAL	0 265 005 712		
						EAL	0 265 005 711		
		09.07-07.10	200			EAL	0 265 005 712		
						EAL	0 265 005 711		



		S							
	◀ BMW Serie 6 Cabrio [E 64]								
	635 d	09.07-07.10	210			EAL	0 265 005 712		
						EAL	0 265 005 711		
	645 i	04.04-09.05	245				0 265 005 266		
						AFP,EAL	0 265 005 285		
	650 i	09.05-07.10	270			EAL	0 265 005 712		
						EAL	0 265 005 711		
Serie 6 [E 63]									
	M 6	03.05-07.10	373			JBH	0 986 481 012		
	630 i	09.04-07.10	190/200			JBH	0 986 481 012		
	635 d	09.07-07.10	210			JBH	0 986 481 012		
	645 i	01.04-09.05	245			JBH	0 986 481 012		
	650 i	09.05-07.10	270			JBH	0 986 481 012		
	630 i	09.04-05.08	190/200				0 986 486 534	22,2	
		06.08-07.10	190/200				0 986 486 607	22,2	
	645 i	01.04-09.05	245				0 986 486 534	22,2	
	650 i	09.05-05.08	270				0 986 486 534	22,2	
		06.08-07.10	270				0 986 486 607	22,2	
	630 i	09.04-09.05	190			EAL	0 265 234 137 ^T		
						EAL	0 265 234 135 ^T		
		10.05-08.07	190			EAL	0 265 236 023 ^T		
						EAL	0 265 236 021 ^T		
	645 i	01.04-09.05	245			EAL	0 265 234 137 ^T		
						EAL	0 265 234 135 ^T		
	650 i	09.05-08.07	270			EAL	0 265 236 023 ^T		
						EAL	0 265 236 021 ^T		
	630 i	09.04-09.05	190				0 265 005 266		
						AFP,EAL	0 265 005 285		
		10.05-07.10	190			EAL	0 265 005 712		
						EAL	0 265 005 711		
		09.07-07.10	200			EAL	0 265 005 712		
						EAL	0 265 005 711		
	635 d	09.07-07.10	210			EAL	0 265 005 712		
						EAL	0 265 005 711		
	645 i	01.04-09.05	245				0 265 005 266		
						AFP,EAL	0 265 005 285		
	650 i	09.05-07.10	270			EAL	0 265 005 712		
						EAL	0 265 005 711		
Serie 7 [E 32]									
	730 i, iL	04.88-06.94	136-145			JBH GIR	0 986 480 598	25,4	
		09.91-10.94	160			JBH,LLE	0 986 480 601	25,4	
	740 i, iL	09.91-10.94	210			JBH,LLE	0 986 480 601	25,4	
	750 i, iL	09.87-10.94	220			JBH	0 986 480 597	25,4	
	730 i, iL	09.86-10.94	136-145/ 160				0 986 486 028	19,05	
	730 i, iL	09.86-06.94	136-145				0 986 486 539	22,2	
		09.91-10.94	160				0 986 486 534	22,2	
	730 i, iL	01.91-10.94	136-145/160				0 265 100 055 ^H		
	740 i, iL	09.91-10.94	210				0 265 100 055 ^H		
	750 i, iL	09.87-10.94	220				0 265 100 049 ^H		























Serie 7 [E 38]

Icon	Model	Period	Power (kW)	Code	Price	Price
	725 tds	01.96-09.97	105		0 986 480 604	20,6
		10.97-09.98	105	JBH	0 986 480 925	25,4
		10.98-12.00	105	JBH	0 986 480 976	25,4
	728 i, iL	09.95-09.97	142		0 986 480 604	20,6
				JBH,RLE	0 986 480 605	20,6
		10.97-09.98	142	JBH	0 986 480 925	25,4
	730 d	08.98-12.01	135-142		0 986 480 976	25,4
		08.98-12.01	135-142	JBH	0 986 480 925	25,4
		06.94-12.96	155-160	LLE	0 986 480 604	20,6
	730 i, iL	06.94-12.96	155-160		0 986 480 604	20,6
				JBH,RLE	0 986 480 605	20,6
		09.94-09.97	173-175	LLE	0 986 480 604	20,6
	735 i, iL	09.94-09.97	173-175		0 986 480 604	20,6
				JBH,RLE	0 986 480 605	20,6
		10.97-09.98	173-175	JBH	0 986 480 925	25,4
740 d	10.98-12.01	180		0 986 480 976	25,4	
	10.98-12.01	180	JBH	0 986 480 925	25,4	
	06.94-09.97	210	LLE	0 986 480 604	20,6	
740 i, iL	06.94-09.97	210		0 986 480 604	20,6	
			JBH,RLE	0 986 480 605	20,6	
	10.97-09.98	210	JBH	0 986 480 925	25,4	
750 i, iL	10.98-08.01	210		0 986 480 976	25,4	
	06.94-09.97	240/241	LLE	0 986 480 604	20,6	
			JBH,RLE	0 986 480 605	20,6	
725 tds	01.96-05.96	105		0 986 486 052	19,05	
	06.96-09.97	105		0 986 486 039	19,05	
	09.95-05.96	142		0 986 486 052	19,05	
728 i, iL	06.96-09.97	142		0 986 486 039	19,05	
	06.94-12.96	155-160		0 986 486 052	19,05	
730 i, iL	06.94-12.96	155-160		0 986 486 052	19,05	
735 i, iL	09.94-09.96	173-175		0 986 486 052	19,05	
740 i, iL	06.94-09.96	210		0 986 486 052	19,05	
	725 tds	01.96-12.00	105		0 986 486 534	22,2
	728 i, iL	09.95-10.01	142		0 986 486 534	22,2
	730 i, iL	06.94-12.96	155-160		0 986 486 534	22,2
	735 i, iL	09.94-10.01	173-175		0 986 486 534	22,2
	740 i, iL	01.96-08.01	210		0 986 486 534	22,2
	725 tds	01.96-09.98	105		0 265 217 002 ^J	
		10.98-12.00	105	GRG	0 265 223 002 ^F	
		09.95-09.96	142		0 265 213 011 ^H	
	728 i, iL	09.95-09.98	142		0 265 217 002 ^J	
		10.98-10.01	142	GRG	0 265 223 002 ^F	
					0 265 225 006 ^T	
	730 d	08.98-12.01	135-142		0 265 223 002 ^F	
		10.98-12.01	135-142	GRG	0 265 225 006 ^T	
	730 i, iL	06.94-09.96	155-160		0 265 213 011 ^H	
		06.94-12.96	155-160		0 265 217 002 ^J	
	735 i, iL	09.94-09.98	173-175		0 265 217 002 ^J	
		10.98-10.01	173-175	GRG	0 265 225 006 ^T	
	740 d	10.98-12.01	180	GRG	0 265 225 006 ^T	
	740 i, iL	06.94-06.96	210		0 265 213 011 ^H	
		06.94-09.98	210		0 265 217 002 ^J	
01.96-09.98		210		0 265 202 411 ^M		
750 i, iL	10.98-08.01	210	GRG	0 265 225 006 ^T		
	06.94-09.98	240/241		0 265 202 025 ^M		
				0 265 217 002 ^J		



		S							
BMW Serie 7 [E 38]									
		750 i, iL	10.98-08.01	240/241		GRG	0 265 225 006 ^T		
		725 tds	01.96-09.98	105		THE	0 265 109 016 ^J		
		728 i, iL	09.95-09.96	142		THE	0 265 108 011 ^H		
			09.95-09.98	142			0 265 109 023 ^J		
		730 i, iL	06.94-09.96	155-160		THE	0 265 108 011 ^H		
		735 i, iL	09.94-09.98	173-175			0 265 109 077 ^J		
		740 i, iL	06.94-06.96	210		THE	0 265 108 011 ^H		
			01.96-09.98	210			0 265 109 077 ^J		
						GRA	0 265 109 402 ^M		
		750 i, iL	06.94-09.97	240/241		GRA	0 265 109 027 ^M		
			06.94-09.98	240/241			0 265 109 015 ^J		
			10.97-09.98	240/241		GRA	0 265 109 413 ^M		
		728 i, iL	10.98-10.01	142			0 265 005 248		
		730 d	10.98-12.01	135-142			0 265 005 248		
		735 i, iL	10.98-10.01	173-175			0 265 005 248		
		740 d, i, iL	10.98-12.01	180/210			0 265 005 248		
		750 i, iL	10.98-08.01	240/241			0 265 005 248		
		728 i, iL	10.98-10.01	142			0 265 005 303		
		730 d	10.98-12.01	135-142			0 265 005 303		
		735 i, iL	10.98-10.01	173-175			0 265 005 303		
		740 d, i, iL	10.98-12.01	180/210			0 265 005 303		
		750 i, iL	10.98-08.01	240/241			0 265 005 303		
Serie 7 [E 65]									
		730 d, i	10.02-10.08	160/170/190		JBH	0 986 481 026	27	
		735 i	11.01-03.05	200		JBH	0 986 481 026	27	
		740 d, i	10.02-10.08	190/225		JBH	0 986 481 026	27	
		745 d, i	11.01-10.08	220/242/245		JBH	0 986 481 026	27	
		750 i	04.05-10.08	270		JBH	0 986 481 026	27	
		760 i	12.02-10.08	327		JBH	0 986 481 026	27	
		730 d, i	10.02-10.08	160/170/190			0 265 225 414 ^T		
		735 i	11.01-03.05	200			0 265 225 414 ^T		
		740 d, i	10.02-10.08	190/225			0 265 225 414 ^T		
		745 d, i	11.01-10.08	220/242/245			0 265 225 414 ^T		
		750 i	04.05-10.08	270			0 265 225 414 ^T		
		760 i	12.02-10.08	327			0 265 225 414 ^T		
		730 d, i	10.02-10.08	160/170/190			0 265 005 285		
		735 i	11.01-03.05	200			0 265 005 285		
		740 d, i	10.02-10.08	190/225			0 265 005 285		
		745 d, i	11.01-10.08	220/242/245			0 265 005 285		
		750 i	04.05-10.08	270			0 265 005 285		
		760 i	12.02-10.08	327			0 265 005 285		
		730 d, i	10.02-10.08	160/170/190			0 265 005 303		
		735 i	11.01-03.05	200			0 265 005 303		
		740 d, i	10.02-10.08	190/225			0 265 005 303		
		745 d, i	11.01-10.08	220/242/245			0 265 005 303		
		750 i	04.05-10.08	270			0 265 005 303		
		760 i	12.02-10.08	327			0 265 005 303		
Serie 7 [E 66]									
		730 Ld, Li	04.05-10.08	170/190		JBH	0 986 481 026	27	
		735 Li	03.02-03.05	200		JBH	0 986 481 026	27	



		S							
	740 Li	04.05-10.08	225			JBH	0 986 481 026	27	
	745 Li	03.02-03.05	245			JBH	0 986 481 026	27	
	750 Li	04.05-10.08	270			JBH	0 986 481 026	27	
	760 Li	12.02-10.08	327			JBH	0 986 481 026	27	
	730 Ld, Li	03.03-10.08	170/190				0 265 225 414 ^T		
	735 Li	03.02-03.05	200				0 265 225 414 ^T		
	740 Li	04.05-10.08	225				0 265 225 414 ^T		
	745 Li	03.02-03.05	245				0 265 225 414 ^T		
	750 Li	04.05-10.08	270				0 265 225 414 ^T		
	760 Li	12.02-10.08	327				0 265 225 414 ^T		
	730 Ld, Li	03.03-10.08	170/190				0 265 005 285		
	735 Li	03.02-03.05	200				0 265 005 285		
	740 Li	04.05-10.08	225				0 265 005 285		
	745 Li	03.02-03.05	245				0 265 005 285		
	750 Li	04.05-10.08	270				0 265 005 285		
	760 Li	12.02-10.08	327				0 265 005 285		
	730 Ld, Li	03.03-10.08	170/190				0 265 005 303		
	735 Li	03.02-03.05	200				0 265 005 303		
	740 Li	04.05-10.08	225				0 265 005 303		
	745 Li	03.02-03.05	245				0 265 005 303		
	750 Li	04.05-10.08	270				0 265 005 303		
	760 Li	12.02-10.08	327				0 265 005 303		
Serie 7 [F 01]									
									
	730 d, d xDrive, i	11.08-06.13	180/190			JBH	0 986 481 012		
	740 d, d xDrive, i	11.08-06.13	225/230/235/240			JBH	0 986 481 012		
	750 d xDrive, i, i xDrive	11.08-06.13	280/300			JBH	0 986 481 012		
	750 i	07.12-06.13	330			JBH	0 986 481 012		
	750 i xDrive	07.12→	330			JBH	0 986 481 012		
	760 i	09.09-06.13	400			JBH	0 986 481 012		
Serie 7 [F 02]									
									
	730 Ld	03.09-06.12	180			JBH	0 986 481 012		
		07.12→	190			JBH	0 986 481 012		
	730 Li	05.09-06.13	190			JBH	0 986 481 012		
	740 Li, Li xDrive	11.08-06.13	235/240			JBH	0 986 481 012		
	750 Ld xDrive, Li, Li xDrive	11.08-06.13	280/300			JBH	0 986 481 012		
	750 Li, Li xDrive	07.12→	330			JBH	0 986 481 012		
	760 Li	09.09-06.13	400			JBH	0 986 481 012		
Serie 8 [E 31]									
									
	840 Ci, i	04.93-12.99	210				0 986 486 028	19,05	
	850 CSI, i, Ci	07.89-10.96	220/280				0 986 486 028	19,05	
	840 Ci, i	10.93-12.99	210				0 265 217 002 ^J		
	850 Ci	03.94-12.99	240				0 265 217 002 ^J		





BOGDAN

2110

	211010	12.09→	59,5		JBH	0986 480 862	20,6
	211040	12.09→	65,5		JBH	0986 480 862	20,6

2111

	211120	12.09→	59,5		JBH	0986 480 862	20,6
	211140	12.09→	65,5		JBH	0986 480 862	20,6

2310

	231010	12.09→	59,5		JBH	0986 480 862	20,6
	231040	12.09→	65,5		JBH	0986 480 862	20,6

CADILLAC

Catera

	3.0	10.96-12.01	149			0265 220 449 ^J	
	3.0	10.96-12.01	149		TEI	1273 004 206 ^J	

CHEVROLET

Aveo Hatchback [T300]

	1.2	06.11→	51/63			0986 486 588	31
	1.3D	09.11→	55			0986 486 588	31
			70			0986 486 591	34
	1.4	06.11→	74			0986 486 588	31
	1.4 Turbo	06.13-12.14	103			0986 486 591	34
		01.15→	103		SSJ	0986 486 591	34

Aveo [T300]

	1.2	06.11→	51/63			0986 486 588	31
	1.3D	09.11→	55			0986 486 588	31
			70			0986 486 591	34
	1.4	06.11→	74			0986 486 588	31

Calibra

	2.0 16V	ABS 10.93-03.96	110,3		JBH ATE	0986 480 907	22



	2.0 16V	10.93-03.96	110,3				0 265 208 311 ^H		
Captiva [C140]									
	2.2 CDRI 2.2 CDRI 4x4	04.11→	120/135				0 986 486 579	34	
Corsa Wagon									
	1.0 MPFI 16V	04.99-07.02	50		JBH	ATE	0 986 BB3 252	20,64	
Corvette Cabrio									
	5.7	09.91-09.01	225				0 265 212 004 ^J		
	5.7	09.92-09.01	225				0 265 005 041		
Corvette Coupé									
	5.7	09.91-08.95	302				0 265 212 004 ^J		
	5.7	09.92-08.95	302				0 265 005 041		
Cruze Hatchback [J305]									
	1.4	08.13→	74				0 986 486 588	31	
Cruze [J300]									
	1.4	08.13→	74				0 986 486 588	31	
Cruze Station Wagon [J308]									
	1.4	08.13→	74				0 986 486 588	31	
Evanda [V200]									
	2.0i	ABO 02.03-09.06	96	Fg.-Nr. →196876			F 01G 19B 0HT		
				Fg.-Nr. 196877→			F 01G 160 05F		
		ABS 02.03-09.06	96	Fg.-Nr. →196876			F 01G 19B 0HU		
				Fg.-Nr. 196877→			F 01G 160 06D		



		S							
CHEVROLET Evanda [V200]									
	2.0 i	ASR	02.03-12.04	96				F 01G 19B 0HV	
			01.05-09.06	96	Fg.-Nr. →196876		F 01G 160 028		
					Fg.-Nr. 196877→		F 01G 160 06E		
	2.0 i		02.03-09.06	96				F 01G 09B 169	
	2.0 i		02.03-09.06	96				F 026 A06 055	
Lacetti [J200]									
	1.4		02.05-04.13	70				0 986 486 614	23
			02.05-04.13	80			0 986 486 614	23	
			02.05-04.13	89/90			0 986 486 614	23	
	1.4		02.05-12.06	70				0 265 216 875^B	
								0 265 220 651^F	
								0 265 216 875^B	
								0 265 220 651^F	
								0 265 216 875^B	
1.6		02.05-12.06	80					0 265 220 651^F	
								0 265 216 875^B	
1.8		02.05-12.06	89/90					0 265 216 875^B	
								0 265 220 651^F	
2.0 D		09.06-12.06	89					0 265 216 875^B	
								0 265 220 651^F	
Lanos									
	1.5 i	ABO	01.04→	63	Fg.-Nr. →447433	AG, ^J BH	0 986 481 040	20,64	
			01.04→	63	Fg.-Nr. →447433	GS, ^J BH	0 986 481 041	20,64	
			01.04→	63	Fg.-Nr. →447433	GS, ^J BH	0 986 480 996	22	
			01.04→	78		AG, ^J BH	0 986 481 039	22,2	
			01.04→	78	Fg.-Nr. →447433	GS	F 026 A05 885		
1.6 i	ABS	01.04→	78	Fg.-Nr. →447433	AG, ^J BH	0 986 480 867			
	1.5 i		01.04→	63	Fg.-Nr. 371633→	RLE	F 026 A05 957		
			01.04→	78	Fg.-Nr. 371633→	RLE	F 026 A05 957		
	1.5 i		01.04→	63			F 026 A06 055		
			01.04→	78			F 026 A06 055		
Matiz [M200]									
	0.8 i		02.05-12.10	38	Fg.-Nr. →199333		0 265 216 990^B		
			02.05-12.10	48	Fg.-Nr. →199333		0 265 216 990^B		
Niva									
	1.7 i		09.02→	58,5			0 265 218 611^H		
Niva [212360]									
	1.8 MT		09.04→	92			0 265 218 611^H		



Nubira [J200]

	1.4 i	02.05-04.13	70		0 986 486 614 23
	1.6 i	02.05-04.13	80		0 986 486 614 23
	1.8 i	02.05-04.13	89/90		0 986 486 614 23
	1.4 i	02.05-12.06	70		0 265 216 875 ^B 0 265 220 651 ^F
	1.6 i	02.05-12.06	80		0 265 216 875 ^B 0 265 220 651 ^F
	1.8 i	02.05-12.06	89/90		0 265 216 875 ^B 0 265 220 651 ^F
	2.0 D	09.06-12.06	89		0 265 216 875 ^B 0 265 220 651 ^F

Nubira Wagon [J200]

	1.6 i	02.05-04.13	80		0 986 486 614 23
	1.8 i	02.05-04.13	89/90		0 986 486 614 23
	1.6 i	02.05-12.06	80		0 265 216 875 ^B 0 265 220 651 ^F
	1.8 i	02.05-12.06	89/90		0 265 216 875 ^B 0 265 220 651 ^F
	2.0 D	09.06-12.06	89		0 265 216 875 ^B 0 265 220 651 ^F

Optra Hatchback [J200]

	1.6	09.02-08.14	80		0 986 486 614 23
	1.8	01.03-12.07	90		0 986 486 614 23
	1.6	09.02-12.06	80		0 265 216 875 ^B 0 265 220 651 ^F
	1.8	01.03-12.06	90		0 265 216 875 ^B 0 265 220 651 ^F

Rezzo [U100]

	1.6 i	02.05-05.09	74-79	RLE	F 01G 09C 1D2
		ABS 02.05-05.09	74-79	LLE	F 01G 19B 0JB
	2.0 i	02.05-05.09	88-90	RLE	F 01G 09C 1D2
		ABS 02.05-05.09	88-90	LLE	F 01G 19B 0JB
	1.6 i	02.05-05.09	74-79		F 026 A06 055
	2.0 i	02.05-05.09	88-90		F 026 A06 055

Spark [M200]

	0.8 i	02.05-12.10	38	Fg.-Nr. →199333	0 265 216 990 ^B
	1.0 i	02.05-12.10	48	Fg.-Nr. →199333	0 265 216 990 ^B





◀ CHEVROLET

Tavera



	2.5 D	05.04→	59		0 204 318 026	
	2.5 D	05.04→	59		0 204 318 541	

Trax



	1.4 Turbo, Turbo AWD	11.12-12.14	103		0 986 486 591	34
	1.7 CDI, CDI AWD	11.12→	96		0 986 486 590	34

CHRYSLER

Neon [PL]



	1.6 i 4x4	01.01-12.05	85		0 204 787 047	
	2.0 i 16V	09.99-12.05	98/112		0 204 787 047	
	2.4 i	01.03-12.05	172		0 204 787 047	

CITROEN

AX



	Electrique	09.94-12.98	11-20		BSY		0 204 124 069 ⁶
					JBH ATE	F 026 003 103	19
					BSY	F 026 003 180	20,6
	1.0 i	07.92-12.98	31-33/37		JBH ATE	F 026 003 103	19
				Org.-Nr. 3826→	BSY		0 204 124 069 ⁶
					JBH BSY	F 026 003 180	20,6
				Org.-Nr. 5278→	BSY		0 204 124 068 ⁶
					JBH BSY	F 026 003 103	19
		ABS 07.92-12.98	31-33/37				0 204 124 063 ⁶
					JBH	F 026 003 174	22,2
	1.1 i	06.92-06.98	44				0 204 124 068 ⁶
					JBH	F 026 003 103	19
		ABS 06.92-06.98	44				0 204 124 063 ⁶
					JBH	F 026 003 174	22,2
	1.4 D	08.91-12.97	37-39/55				0 204 124 068 ⁶
	1.4 i				JBH	F 026 003 103	19
		ABS 05.91-12.97	37-39/55-58/ 66/69-74				0 204 124 063 ⁶
					JBH	F 026 003 174	22,2
	1.4 i	06.88-12.98	55-58		JBH ATE	F 026 003 103	19
		04.91-12.96	55-58	Org.-Nr. 5278→	BSY		0 204 124 068 ⁶
					JBH BSY	F 026 003 103	19
		05.91-12.96	66/69-74		BSY		0 204 124 069 ⁶
					JBH ATE	F 026 003 103	19
					BSY	F 026 003 180	20,6
	1.5 D	08.94-12.97	40-41/ 42-43				0 204 124 068 ⁶
					JBH	F 026 003 103	19
		ABS 08.94-12.97	40-41/ 42-43				0 204 124 063 ⁶
					JBH	F 026 003 174	22,2





	Electrique	09.94-12.98	11-20		ATE	0 986 485 094			
					BSY	0 204 125 104			
	1.0 i	07.92-12.98	31-33/37		ATE	0 986 485 094			
		ABO 07.92-12.98	31-33/37	Org.-Nr. 5278→		BSY	0 204 125 102		
					RLE	BSY	0 204 125 094		
		ABS 07.92-12.98	31-33/37	Org.-Nr. 5278→		BSY	0 204 125 104		
	1.1 i	06.92-06.98	44		ATE	0 986 485 094			
		ABO 06.92-06.98	44	Org.-Nr. 5278→		BSY	0 204 125 102		
					RLE	BSY	0 204 125 094		
		ABS 06.92-06.98	44	Org.-Nr. 5278→		BSY	0 204 125 104		
	1.4 D, i	06.88-12.98	37-39/55-58		ATE	0 986 485 094			
		ABO 04.91-12.97	37-39/55-58	Org.-Nr. 5278→		BSY	0 204 125 102		
					RLE	BSY	0 204 125 094		
		ABS 04.91-12.97	37-39/55-58	Org.-Nr. 5278→		BSY	0 204 125 104		
	1.4 i	05.91-12.96	66/69-74		ATE	0 986 485 094			
				BSY	0 204 125 104				
1.5 D	08.94-12.97	40-41/42-43		ATE	0 986 485 094				
	ABO 08.94-12.97	40-41/42-43	Org.-Nr. 5278→		BSY	0 204 125 102			
				RLE	BSY	0 204 125 094			
	ABS 08.94-12.97	40-41/42-43	Org.-Nr. 5278→		BSY	0 204 125 104			

	Electrique	ABO 09.94-12.98	11-20		AA	0 204 131 043 ^A		
		ABS 09.94-12.98	11-20			0 204 131 065 ^A		
	1.0 i	ABO 07.92-12.98	31-33/37		AA	0 204 131 043 ^A		
		ABS 07.92-12.98	31-33/37			0 204 131 065 ^A		
	1.1 i	ABO 06.92-06.98	44		AA	0 204 131 043 ^A		
		ABS 06.92-06.98	44			0 204 131 065 ^A		
	1.4 D, i	ABO 06.88-12.98	37-39/55-58/66/69-74		AA	0 204 131 043 ^A		
		ABS 06.88-12.98	37-39/55-58/66/69-74			0 204 131 065 ^A		
	1.4 i	06.88-12.98	55-58/66/69-74		AA	0 204 131 046		
	1.5 D	ABO 08.94-12.97	40-41/42-43		AA	0 204 131 043 ^A		
		ABS 08.94-12.97	40-41/42-43			0 204 131 065 ^A		

Berlingo [B9]

	1.6	05.08-11.11	66/68			0 986 486 616	19
	1.6 BlueHdi, HDi	05.08→	55-66			0 986 486 616	19
	1.6 HDi	10.08→	66/68			0 986 486 616	19
		07.10→	66/68		GS	0 986 486 616	19
	1.6 HDi, VTi, 16V	05.08→	72/80/82/84/88			0 986 486 616	19
	1.6	05.08-11.11	66			0 265 232 520 ^B	
	1.6, HDi	05.08-11.11	66		TW	0 265 230 509 ^T	
	1.6 BlueHdi	12.14→	88		TW	0 265 230 509 ^T	
		03.15→	55		TW	0 265 230 509 ^T	
	1.6 HDi	05.08-11.11	55			0 265 232 520 ^B	
			55-66		TW	0 265 230 509 ^T	
					TW	0 265 232 520 ^B	
		10.08-11.11	66			0 265 232 520 ^B	
		03.10-03.12	82/84	Org.-Nr. →12900		0 265 232 520 ^B	
		07.10-03.12	66	Org.-Nr. →12900		0 265 232 520 ^B	
		08.10-03.12	55	Org.-Nr. →12900		0 265 232 520 ^B	
	1.6 HDi, VTi	03.10-03.12	68/72	Org.-Nr. →12900		0 265 232 520 ^B	
	1.6 HDi	05.08-11.11	80			0 265 232 520 ^B	
	1.6 16V				TW	0 265 230 509 ^T	
	1.6 VTi	11.09-03.12	88	Org.-Nr. →12900		0 265 232 520 ^B	





◀ CITROEN Berlingo [B9]













	1.6, HDi, 16V	05.08-11.08	55-66/80	Org.-Nr. →11682		0 265 005 715	
--	---------------	-------------	----------	-----------------	--	---------------	--

Berlingo [M49]



	Electrique	ABO	10.98-06.00	24	Org.-Nr. →8609			0 204 124 073 ⁶
			07.00-11.02	24	Org.-Nr. 8610→	JBH	F 026 003 190	23,8
						BO	0 204 123 373	23,81
								0 204 124 073 ⁶
	ABS		10.98-06.00	24	Org.-Nr. →8609	JBH,LLE	F 026 003 192	23,8
			07.00-11.02	24	Org.-Nr. 8610→	RLE	0 204 123 341	23,8
						BO	F 026 003 350	23,81
								0 204 124 073 ⁶
	1.1 i	ABO	07.96-06.00	44	Org.-Nr. →8609			0 204 124 073 ⁶
			07.00-11.02	44	Org.-Nr. 8610→	JBH	F 026 003 190	23,8
						BO	0 204 123 373	23,81
								0 204 124 073 ⁶
	ABS		07.96-06.00	44	Org.-Nr. →8609	JBH,LLE	F 026 003 192	23,8
			07.00-11.02	44	Org.-Nr. 8610→	RLE	0 204 123 341	23,8
						BO	F 026 003 350	23,81
								0 204 124 073 ⁶
	1.4	ABO	07.96-06.00	51/55	Org.-Nr. →8609			0 204 124 073 ⁶
	1.4 i		07.00-11.02	51/55	Org.-Nr. 8610→	JBH	F 026 003 190	23,8
						BO	0 204 123 373	23,81
								0 204 124 073 ⁶
	ABS		07.96-06.00	51/55	Org.-Nr. →8609	JBH,LLE	F 026 003 192	23,8
			07.00-11.02	51/55	Org.-Nr. 8610→	RLE	0 204 123 341	23,8
						BO	F 026 003 350	23,81
								0 204 124 073 ⁶
	1.6 i 16V	ABO	06.00-06.00	80	Org.-Nr. →8609			0 204 124 073 ⁶
			07.00-11.02	80	Org.-Nr. 8610→	JBH	F 026 003 190	23,8
						BO	0 204 123 373	23,81
								0 204 124 073 ⁶
	ABS		06.00-06.00	80	Org.-Nr. →8609	JBH,LLE	F 026 003 192	23,8
			07.00-11.02	80	Org.-Nr. 8610→	RLE	0 204 123 341	23,8
						BO	F 026 003 350	23,81
								0 204 124 073 ⁶
	1.8 D	ABO	07.96-06.00	43-44/66	Org.-Nr. →8609			0 204 124 073 ⁶
	1.8 i		07.00-11.02	43-44/66	Org.-Nr. 8610→	JBH	F 026 003 190	23,8
						BO	0 204 123 373	23,81
								0 204 124 073 ⁶
	ABS		07.96-06.00	43-44/66	Org.-Nr. →8609	JBH,LLE	F 026 003 192	23,8
			07.00-11.02	43-44/66	Org.-Nr. 8610→	RLE	0 204 123 341	23,8
						BO	F 026 003 350	23,81
								0 204 124 073 ⁶
	1.9 D	ABO	07.96-06.00	50-51/52	Org.-Nr. →8609			0 204 124 073 ⁶
			07.00-11.02	50-51/52	Org.-Nr. 8610→	JBH	F 026 003 190	23,8
						BO	0 204 123 373	23,81
								0 204 124 073 ⁶
	ABS		07.96-06.00	50-51/52	Org.-Nr. →8609	JBH,LLE	F 026 003 192	23,8
			07.00-11.02	50-51/52	Org.-Nr. 8610→	RLE	0 204 123 341	23,8
						BO	F 026 003 350	23,81
								0 204 124 073 ⁶
	2.0 HDi	ABO	12.99-11.02	66			0 204 123 373	23,81
		ABS	12.99-11.02	66			F 026 003 350	23,81

	Electrique		10.98-06.00	24	Org.-Nr. →8609		0 204 125 134	
			07.00-11.02	24	Org.-Nr. 8610→	BO	0 204 125 764	
	1.1 i		07.96-06.00	44	Org.-Nr. →8609		0 204 125 134	
			07.00-11.02	44	Org.-Nr. 8610→	BO	0 204 125 764	
	1.4		07.96-06.00	51/55	Org.-Nr. →8609		0 204 125 134	
	1.4 i		07.00-11.02	51/55	Org.-Nr. 8610→	BO	0 204 125 764	
	1.6 i 16V		06.00-06.00	80	Org.-Nr. →8609		0 204 125 134	
			07.00-11.02	80	Org.-Nr. 8610→	BO	0 204 125 764	
	1.8 D		07.96-06.00	43-44/66	Org.-Nr. →8609		0 204 125 134	
	1.8 i		07.00-11.02	43-44/66	Org.-Nr. 8610→	BO	0 204 125 764	
	1.9 D		07.96-06.00	50-51	Org.-Nr. →8609		0 204 125 134	
			07.98-06.00	52	Org.-Nr. →8609		0 204 125 134	
			07.00-11.02	50-51	Org.-Nr. 8610→	BO	0 204 125 764	
				52	Org.-Nr. 8610→	BO	0 204 125 764	
			09.00-11.02	52			0 204 125 764	
	2.0 HDi		12.99-11.02	66			0 204 125 514	

		S							
	Electrique	10.98-11.02	24				0 986 482 031 ^A		
	1.1 i	07.96-11.02	44			TW	0 986 482 029 ^A		
							0 986 482 030 ^A		
							0 986 482 031 ^A		
	1.4	07.96-11.02	51/55			TW	0 986 482 029 ^A		
	1.4 i						0 986 482 030 ^A		
							0 986 482 031 ^A		
	1.6 i 16V	06.00-11.02	80			TW	0 986 482 029 ^A		
							0 986 482 030 ^A		
							0 986 482 031 ^A		
	1.8 D	07.96-11.02	43-44/66			TW	0 986 482 029 ^A		
	1.8 i						0 986 482 030 ^A		
							0 986 482 031 ^A		
	1.9 D	07.96-11.02	50-51/52			TW	0 986 482 029 ^A		
							0 986 482 030 ^A		
						0 986 482 031 ^A			
2.0 HDi	12.99-11.02	66			TW	0 986 482 029 ^A			
						0 986 482 030 ^A			
						0 986 482 031 ^A			
	Electrique	10.98-11.02	24				0 265 216 721 ^B		
	1.1 i	07.96-11.02	44				0 265 216 721 ^B		
	1.4, i	07.96-11.02	51/55				0 265 216 721 ^B		
	1.6 i 16V	06.00-11.02	80				0 265 216 721 ^B		
	1.8 D, i	07.96-11.02	43-44/66				0 265 216 721 ^B		
	1.9 D	07.96-11.02	50-51/52				0 265 216 721 ^B		
	2.0 HDi	12.99-11.02	66				0 265 216 721 ^B		
	Electrique	10.98-11.02	24				0 273 004 112 ^H		
	1.1 i	07.96-11.02	44				0 273 004 112 ^H		
	1.4, i	07.96-11.02	51/55				0 273 004 112 ^H		
	1.6 i 16V	06.00-11.02	80				0 273 004 112 ^H		
	1.8 D, i	07.96-11.02	43-44/66				0 273 004 112 ^H		
	1.9 D	07.96-11.02	50-51/52				0 273 004 112 ^H		
	2.0 HDi	12.99-11.02	66				0 273 004 112 ^H		
Berlingo [M59]									
	Electrique	ABO 11.02-04.08	28				0 204 123 373	23,81	
		ABS 11.02-04.08	28				F 026 003 350	23,81	
		MFD 11.02-04.08	28			LLE	0 204 123 644	23,8	
						RLE	0 204 123 645	23,8	
	1.1 i	ABO 11.02-04.08	44				0 204 123 373	23,81	
		ABS 11.02-04.08	44				F 026 003 350	23,81	
		MFD 11.02-04.08	44			LLE	0 204 123 644	23,8	
						RLE	0 204 123 645	23,8	
	1.4 i	ABO 11.02-03.10	55				0 204 123 373	23,81	
		ABS 11.02-03.10	55				F 026 003 350	23,81	
		MFD 11.02-03.10	55			LLE	0 204 123 644	23,8	
						RLE	0 204 123 645	23,8	
	1.6 HDi	ABO 11.02-10.11	55/66/80				0 204 123 373	23,81	
	1.6 i 16V	ABS 11.02-10.11	55/66/80				F 026 003 350	23,81	
		MFD 11.02-10.11	55/66/80			LLE	0 204 123 644	23,8	
						RLE	0 204 123 645	23,8	
	1.9 D	ABO 11.02-04.08	52				0 204 123 373	23,81	
		ABS 11.02-04.08	52				F 026 003 350	23,81	
		MFD 11.02-04.08	52			LLE	0 204 123 644	23,8	
						RLE	0 204 123 645	23,8	
	2.0 HDi	ABO 11.02-04.08	66				0 204 123 373	23,81	
		ABS 11.02-04.08	66				F 026 003 350	23,81	

CITROEN Berlingo [M59]									
2.0 HDi MFD 11.02-04.08 66 LLE 0 204 123 644 23,8 RLE 0 204 123 645 23,8									
Electrique 11.02-04.08 28 LLE 0 204 125 804 RLE 0 204 125 805									
1.1 i 11.02-03.04 44 Org.-Nr. →9974 RLE 0 204 125 805 11.02-04.08 44 LLE 0 204 125 804 04.04-04.08 44 Org.-Nr. 9975→ RLE 0 204 125 804									
1.4 i 11.02-03.04 55 Org.-Nr. →9974 RLE 0 204 125 805 11.02-03.10 55 LLE 0 204 125 804 04.04-03.10 55 Org.-Nr. 9975→ RLE 0 204 125 804									
1.6 HDi 07.05-10.11 55/66 LLE 0 204 125 804 RLE 0 204 125 837									
1.6 i 16V 11.02-03.04 80 Org.-Nr. →9974 RLE 0 204 125 805 11.02-04.08 80 LLE 0 204 125 804 04.04-04.08 80 Org.-Nr. 9975→ RLE 0 204 125 804									
1.9 D 11.02-03.04 52 Org.-Nr. →9974 RLE 0 204 125 805 11.02-04.08 52 LLE 0 204 125 804 04.04-04.08 52 Org.-Nr. 9975→ RLE 0 204 125 804									
2.0 HDi 11.02-03.04 66 Org.-Nr. →9974 RLE 0 204 125 805 11.02-04.08 66 LLE 0 204 125 804 04.04-04.08 66 Org.-Nr. 9975→ RLE 0 204 125 804									
Electrique 11.02-04.08 28 0 986 482 031^A									
1.1 i 11.02-04.08 44 FEN 0 986 482 031^A									
1.4 i 11.02-03.10 55 FEN 0 986 482 031^A									
1.6 HDi, i 16V 11.02-10.11 55/66/80 FEN 0 986 482 031^A									
1.9 D 11.02-04.08 52 FEN 0 986 482 031^A									
2.0 HDi 11.02-04.08 66 FEN 0 986 482 031^A									
Electrique 11.02-11.04 28 Org.-Nr. →10220 0 265 216 721^B 12.04-12.07 28 Org.-Nr. 10221→11346 0 265 231 523^B									
1.1 i 11.02-11.04 44 Org.-Nr. →10220 0 265 216 721^B 12.04-12.07 44 Org.-Nr. 10221→11346 0 265 231 523^B									
1.4 i 11.02-11.04 55 Org.-Nr. →10220 0 265 216 721^B 12.04-12.07 55 Org.-Nr. 10221→11346 0 265 231 523^B									
1.6 HDi 07.05-12.07 55 Org.-Nr. →11346 0 265 231 523^B 09.05-12.07 66 Org.-Nr. →11346 0 265 231 523^B 0 265 234 061^T									
1.6 i 16V 11.02-11.04 80 Org.-Nr. →10220 0 265 216 721^B 0 265 225 130^T 12.04-12.07 80 Org.-Nr. 10221→11346 0 265 231 523^B 0 265 234 061^T									
1.9 D 11.02-11.04 52 Org.-Nr. →10220 0 265 216 721^B 12.04-12.07 52 Org.-Nr. 10221→11346 0 265 231 523^B									
2.0 HDi 11.02-11.04 66 Org.-Nr. →10220 0 265 216 721^B 0 265 225 130^T 12.04-12.07 66 Org.-Nr. 10221→11346 0 265 231 523^B 0 265 234 061^T									
Electrique 11.02-12.07 28 Org.-Nr. →11354 0 265 005 290 01.08-04.08 28 Org.-Nr. 11355→ 0 265 005 758									
1.1 i 11.02-12.07 44 Org.-Nr. →11354 0 265 005 290 01.08-04.08 44 Org.-Nr. 11355→ 0 265 005 758									
1.4 i 11.02-12.07 55 Org.-Nr. →11354 0 265 005 290 01.08-03.10 55 Org.-Nr. 11355→ 0 265 005 758									
1.6 HDi 11.02-12.07 55/66/80 Org.-Nr. →11354 0 265 005 290									
1.6 i 16V 01.08-10.11 55/66/80 Org.-Nr. 11355→ 0 265 005 758									
1.9 D 11.02-12.07 52 Org.-Nr. →11354 0 265 005 290 01.08-04.08 52 Org.-Nr. 11355→ 0 265 005 758									
2.0 HDi 11.02-12.07 66 Org.-Nr. →11354 0 265 005 290 01.08-04.08 66 Org.-Nr. 11355→ 0 265 005 758									



C 15

	E 1.0	07.88-12.97	32		LLE		0 204 124 050 ⁶
					JBH,LLE	F 026 003 076	20,6
					RLE	0 204 123 113	20,6
	E 1.1	07.88-12.96	44		LLE		0 204 124 050 ⁶
	E 1.1 i				JBH,LLE	F 026 003 076	20,6
					RLE	0 204 123 113	20,6
	E 1.4	07.87-12.96	40-46/51	Org.-Nr. →4195	JBH	F 026 003 060	19
		06.88-12.96	40-46/51	Org.-Nr. 4196→	LLE		0 204 124 050 ⁶
					JBH,LLE	F 026 003 076	20,6
					RLE	0 204 123 113	20,6
	E 1.4	05.87-12.96	55-58		LLE		0 204 124 050 ⁶
	E 1.4 i				JBH,LLE	F 026 003 076	20,6
					RLE	0 204 123 113	20,6
	1.8D	07.86-05.00	44		JBH	F 026 003 076	20,6
	1.9D	06.00-12.05	44-52		JBH	F 026 003 076	20,6

	E 1.0	07.88-12.97	32			0 986 482 032 ^A	
	E 1.1, i	07.88-12.96	44			0 986 482 032 ^A	
	E 1.4, i	05.87-12.96	40-46/51/55-58			0 986 482 032 ^A	
	1.8D	07.86-05.00	44			0 986 482 032 ^A	
	1.9D	06.00-12.05	44-52			0 986 482 032 ^A	

C 25

	E 1.8	11.81-03.94	49-51		JBH	F 026 003 150	22,2
	E 2.0	09.81-03.94	55-63		JBH	F 026 003 150	22,2
	1.9D	07.87-03.94	51		JBH	F 026 003 150	22,2
	2.5D	07.81-03.94	54-55		JBH	F 026 003 150	22,2

	E 1.8	08.90-03.94	49-51		L02	0 204 125 550 ^S	
				Org.-Nr. 273004→	AS2,L03	0 204 125 420 ^S	
	E 2.0	08.90-03.94	55-63		L02	0 204 125 550 ^S	
				Org.-Nr. 273004→	AS2,L03	0 204 125 420 ^S	
	1.9D	08.90-03.94	51		L02	0 204 125 550 ^S	
				Org.-Nr. 273004→	AS2,L03	0 204 125 420 ^S	
	1.9D Turbo	04.92-03.94	60			0 204 125 550 ^S	
	2.5D	08.90-03.94	54-55		L02	0 204 125 550 ^S	
				Org.-Nr. 273004→	AS2,L03	0 204 125 420 ^S	
	2.5D Turbo	08.90-03.94	70			0 204 125 550 ^S	

	E 1.8	11.81-03.94	49-51			0 204 131 226 ^A	
	E 2.0	09.81-03.94	55-63			0 204 131 226 ^A	
	1.9D, D Turbo	07.87-03.94	51/60			0 204 131 226 ^A	
	2.5D, D Turbo	07.81-03.94	54-55/70			0 204 131 226 ^A	

C-Elysee

	1.2 VTi	MFD 09.12→	52			0 204 123 811	22,2
		OFD 09.12-05.13	52	Org.-Nr. →13341		0 204 123 809	22,2
	1.6 BlueHdi, HDi	MFD 09.12→	68/73		JBH	0 986 480 853	
	1.6 HDi	OFD 09.12-05.13	68	Org.-Nr. →13341		0 204 123 809	22,2
	1.6 VTi	MFD 09.12→	85			0 204 123 811	22,2
		OFD 09.12-05.13	85	Org.-Nr. →13341		0 204 123 809	22,2
		06.13→	85	Org.-Nr. 13342→	AG	0 204 123 809	22,2



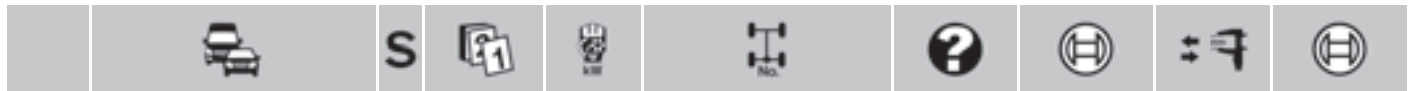

◀ CITROEN C-Elysee

	1.2 VTi	MFD 09.12→	52			0 204 720 419	
		OFD 09.12-05.13	52	Org.-Nr. →13341		0 204 720 418	
		06.13→	52	Org.-Nr. 13342→	GS	0 204 720 418	
	1.6 BlueHDi	OFD 04.15→	73		AG	0 204 720 418	
	1.6 BlueHDi, VTi	MFD 09.12→	73/85			0 204 720 419	
	1.6 HDi	OFD 09.12-05.13	68	Org.-Nr. →13341		0 204 720 418	
		06.13→	68	Org.-Nr. 13342→	GS	0 204 720 418	
	1.6 VTi	OFD 09.12-05.13	85	Org.-Nr. →13341		0 204 720 418	
		06.13→	85	Org.-Nr. 13342→	GS	0 204 720 418	

C1 [B0]



	1.0	MFD 06.05→	50		LLE	0 204 123 787	20,64
					RLE	0 204 123 786	20,64
		OFD 06.05→	50		LLE	0 204 123 667	20,6
					RLE	0 204 123 666	20,6
	1.4 HDi	MFD 06.05→	40		LLE	0 204 123 787	20,64
					RLE	0 204 123 786	20,64
		OFD 06.05→	40		LLE	0 204 123 667	20,6
					RLE	0 204 123 666	20,6

	1.0	06.05-08.10	50		LLE	0 204 125 831	
					RLE	0 204 125 830	
		09.10-09.10	50	Org.-Nr. →12333	LLE	0 204 125 831	
					RLE	0 204 125 830	
		MFD 10.10→	50	Org.-Nr. 12334→	LLE	0 204 125 831	
					RLE	0 204 125 830	
		OFD 10.10→	50	Org.-Nr. 12334→	LLE	0 204 744 467	
					RLE	0 204 744 465	
	1.4 HDi	06.05-09.10	40	Org.-Nr. →12333	LLE	0 204 125 831	
					RLE	0 204 125 830	
		MFD 10.10→	40	Org.-Nr. 12334→	LLE	0 204 125 831	
					RLE	0 204 125 830	
		OFD 10.10→	40	Org.-Nr. 12334→	LLE	0 204 744 467	
					RLE	0 204 744 465	

















	1.0	06.05-08.10	50			0 265 231 580 ^B	
						0 265 231 580 ^B	
	1.4 HDi	09.10-02.12	50	Org.-Nr. →12872		0 265 231 580 ^B	
		06.05-02.12	40	Org.-Nr. →12872		0 265 231 580 ^B	

C1 [B4]



	1.0	MFD 02.14→	50		LLE	0 204 822 666	20,64
					RLE	0 204 822 668	20,64
		OFD 02.14→	50		LLE	0 204 822 665	20,64
					RLE	0 204 822 667	20,64
	1.2 VTi	MFD 02.14→	60		LLE	0 204 822 666	20,64
					RLE	0 204 822 668	20,64
		OFD 02.14→	60		LLE	0 204 822 665	20,64
					RLE	0 204 822 667	20,64

	1.0	MFD 02.14→	50		LLE,SSJ	0 204 822 655	
					LLE,SSJ	0 204 822 653	
					RLE,SSJ	0 204 822 661	
					RLE,SSJ	0 204 822 659	
		OFD 02.14→	50		LLE	0 204 822 651	
					RLE	0 204 822 657	
	1.2 VTi	MFD 02.14→	60		LLE,SSJ	0 204 822 655	
					LLE,SSJ	0 204 822 653	

		S							
1.2 VTi		MFD	02.14→	60			RLE,SSJ	0 204 822 661	
							RLE,SSJ	0 204 822 659	
		OFD	02.14→	60			LLE	0 204 822 651	
							RLE	0 204 822 657	
C2 [A6]									
									
 1.1			09.03-06.06	44	Org.-Nr. →10800		BO	0 204 123 653	22,2
		ABS,	07.06-12.09	44	Org.-Nr. 10801→		TW	0 204 123 653	22,2
		OFD						0 204 123 747	22,2
		MFD	09.03-12.09	44	Org.-Nr. →10800	JBH	LUC	0 986 480 879	22,2
			07.06-12.09	44	Org.-Nr. 10801→	JBH		0 986 480 853	
1.4		ABS,	07.06-12.09	50/55	Org.-Nr. 10801→		TW	0 204 123 653	22,2
1.4 HDi		OFD						0 204 123 747	22,2
		MFD	09.03-12.09	50/55	Org.-Nr. →10800	JBH	LUC	0 986 480 879	22,2
			07.06-12.09	50/55	Org.-Nr. 10801→	JBH		0 986 480 853	
1.4, HDi, 16V			09.03-06.06	50/55/65	Org.-Nr. →10800		BO	0 204 123 653	22,2
1.4 16V		MFD	12.05-06.06	65	Org.-Nr. →10800	JBH	LUC	0 986 480 879	22,2
			12.05-12.08	65	Org.-Nr. 10801→	JBH		0 986 480 853	
1.6			09.03-06.06	80	Org.-Nr. →10800		BO	0 204 123 653	22,2
		MFD	09.03-06.06	80	Org.-Nr. →10800	JBH	LUC	0 986 480 879	22,2
			07.06-12.09	80	Org.-Nr. 10801→	JBH		0 986 480 853	
1.6 HDi			07.07-05.09	80		JBH		0 986 480 853	
1.6 VTS			10.04-06.06	90	Org.-Nr. →10800		BO	0 204 123 653	22,2
			07.06-05.09	90	Org.-Nr. 10801→	JBH		0 986 480 853	
		MFD	10.04-06.06	90	Org.-Nr. →10800	JBH	LUC	0 986 480 879	22,2
 1.1		OFD	09.03-06.06	44	Org.-Nr. →10800		BO	0 204 125 820	
			07.06-07.07	44	Org.-Nr. 10801→11192		TW	0 204 125 820	
1.4		OFD	09.03-06.06	50/55	Org.-Nr. →10800		BO	0 204 125 820	
1.4 HDi			07.06-07.07	50/55	Org.-Nr. 10801→11192		TW	0 204 125 820	
1.4 16V		OFD	12.05-06.06	65	Org.-Nr. →10800		BO	0 204 125 820	
1.6, VTS		OFD	09.03-06.06	80/90	Org.-Nr. →10800		BO	0 204 125 820	
C3									
									
 1.4 HDi			07.03-07.12	52			BO	0 204 123 653	22,2
1.4 8V		ABS,	07.03-07.12	54		JBH		0 986 480 879	22,2
		MFD							
		ABS,	07.03-07.12	54			BO	0 204 123 653	22,2
		OFD							
1.6 16V		ABS,	05.03-07.12	81			BO	0 204 123 653	22,2
		OFD							
		MFD	05.03-07.12	81		JBH	LUC	0 986 480 879	22,2
 1.6 16V		ABS	05.03-07.12	81			BO	0 204 125 820	
C3 [A8]									
									
 1.1 i			01.02-08.05	44			BO	0 204 123 653	22,2
1.4 HDi, HDi 16V, i, i 16V			01.02-08.05	50/55/65/66			BO	0 204 123 653	22,2
1.6 i			01.02-08.05	80			BO	0 204 123 653	22,2
		MFD	01.02-08.05	80		JBH	LUC	0 986 480 879	22,2
 1.1 i		ABS	01.02-08.05	44			BO	0 204 125 820	
1.4 HDi, HDi 16V, i, i 16V		ABS	01.02-08.05	50/55/65/66			BO	0 204 125 820	
1.6 i		ABS	01.02-08.05	80			BO	0 204 125 820	



◀ CITROEN

C3 [A31]











	1.1 i	09.05-06.06	44	Org.-Nr. →10800		BO	0 204 123 653	22,2
		MFD 09.05-06.06	44	Org.-Nr. →10800	JBH	LUC	0 986 480 879	22,2
		07.06-09.09	44	Org.-Nr. 10801→	JBH		0 986 480 853	
		OFD 07.06-09.09	44	Org.-Nr. 10801→	TW		0 204 123 653	22,2
						0 204 123 747	22,2	
	1.4 HDi	OFD 07.06-09.09	50/54	Org.-Nr. 10801→		TW	0 204 123 653	22,2
	1.4 i						0 204 123 747	22,2
	1.4 HDi	09.05-06.06	50/54/65	Org.-Nr. →10800		BO	0 204 123 653	22,2
	1.4 i	MFD 09.05-06.06	50/54/65	Org.-Nr. →10800	JBH	LUC	0 986 480 879	22,2
	1.4 i 16V	07.06-09.09	50/54/65	Org.-Nr. 10801→	JBH		0 986 480 853	
	1.6 HDi	09.05-06.06	66/80	Org.-Nr. →10800		BO	0 204 123 653	22,2
	1.6 i	MFD 09.05-06.06	66/80	Org.-Nr. →10800	JBH	LUC	0 986 480 879	22,2
		07.06-12.09	66/80	Org.-Nr. 10801→	JBH		0 986 480 853	

	1.1 i	OFD 09.05-06.06	44	Org.-Nr. →10800		BO	0 204 125 820	
		07.06-07.07	44	Org.-Nr. 10801→11192	TW		0 204 125 820	
	1.4 HDi	OFD 09.05-06.06	50/54	Org.-Nr. →10800		BO	0 204 125 820	
	1.4 i	07.06-07.07	50/54	Org.-Nr. 10801→11192	TW		0 204 125 820	
	1.4 i 16V	OFD 09.05-06.06	65	Org.-Nr. →10800		BO	0 204 125 820	
	1.6 HDi, i	OFD 09.05-06.06	66/80	Org.-Nr. →10800		BO	0 204 125 820	









C3 [A51]













	1.0 VTi	MFD 09.12→	50				0 204 123 811	22,2	
		OFD 09.12→	50					0 204 123 809	22,2
	1.1	MFD 09.09→	44			BO	0 204 123 811	22,2	
						JBH	TRW	0 986 480 853	
		OFD 09.09→	44			BO	0 204 123 809	22,2	
	1.2 THP	09.14→	81				0 204 123 815	23,81	
	1.2 VTi	MFD 03.12→	60				0 204 123 811	22,2	
		OFD 03.12→	60					0 204 123 809	22,2
	1.4	MFD 09.09→	54			BO	0 204 123 811	22,2	
						JBH	TRW	0 986 480 853	
		OFD 09.09→	54			BO	0 204 123 809	22,2	
	1.4 HDi	MFD 09.09→	50				0 204 123 811	22,2	
		06.10→	50			BO	0 204 123 811	22,2	
					JBH	TRW	0 986 480 853		
		OFD 09.09→	50				0 204 123 809	22,2	
		06.10→	50			BO	0 204 123 809	22,2	
	1.4 VTi	MFD 09.09-11.11	70-72	Org.-Nr. →12774		BO	0 204 123 815	23,81	
		12.11→	70-72	Org.-Nr. 12775→		BO	0 204 123 811	22,2	
		OFD 09.09-11.11	70-72	Org.-Nr. →12774		BO	0 204 123 813	23,81	
		12.11→	70-72	Org.-Nr. 12775→		BO	0 204 123 809	22,2	
	1.4 VTi LPG	MFD 06.13→	70				0 204 123 811	22,2	
		OFD 06.13→	70					0 204 123 809	22,2
	1.6 HDi	09.09→	82/84			BO	0 204 123 815	23,81	
		MFD 09.09→	66					0 204 123 815	23,81
		01.10→	68			HTB BO	0 204 123 811	22,2	
						HTB, JBH	TRW	0 986 480 853	
						4SB BO	0 204 123 815	23,81	
		01.12→	55			BO	0 204 123 811	22,2	
						JBH	TRW	0 986 480 853	
			68			BO	0 204 123 811	22,2	
						JBH	TRW	0 986 480 853	
		04.14→	73				0 204 123 815	23,81	
		09.14→	55				0 204 123 815	23,81	

		S							
1.6 HDi	OFD	09.09→	66				0 204 123 813		23,81
		01.10→	68			HTB	BO	0 204 123 809	22,2
						4SB	BO	0 204 123 813	23,81
		01.12→	55				BO	0 204 123 809	22,2
			68				BO	0 204 123 809	22,2
		04.14→	73					0 204 123 813	23,81
1.6 VTi	MFD	09.09→	88				BO	0 204 123 815	23,81
	OFD	09.09→	88				BO	0 204 123 813	23,81
 1.0 VTi	MFD	09.12→	50			HTB		0 204 720 419	
						4SB		0 204 720 421	
		09.14→	50					0 204 720 419	
	OFD	09.12→	50			HTB		0 204 720 418	
		09.14→	50					0 204 720 420	
1.1	MFD	09.09→	44			HTB,TW		0 204 720 419	
						4SB		0 204 720 421	
	OFD	09.09→	44			HTB,TW		0 204 720 418	
					4SB		0 204 720 420		
1.2 THP		09.14→	81					0 204 720 421	
1.2 VTi	MFD	03.12→	60			HTB		0 204 720 419	
						4SB		0 204 720 421	
	OFD	03.12→	60			HTB		0 204 720 418	
						4SB		0 204 720 420	
1.4	MFD	09.09→	54			HTB,TW		0 204 720 419	
						4SB		0 204 720 421	
		06.15→	53			HTB		0 204 720 419	
						4SB		0 204 720 421	
	OFD	09.09→	54			4SB		0 204 720 420	
		06.15→	53			HTB		0 204 720 418	
						4SB		0 204 720 420	
1.4 HDi	MFD	09.09→	50			HTB		0 204 720 419	
						4SB		0 204 720 421	
		06.10→	50			HTB	BO	0 204 720 419	
	OFD	09.09→	50			HTB		0 204 720 418	
						4SB		0 204 720 420	
		06.10→	50			HTB	BO	0 204 720 418	
1.4 VTi	MFD	09.09→	70-72			HTB,TW		0 204 720 419	
						4SB		0 204 720 421	
	OFD	09.09→	70-72			HTB,TW		0 204 720 418	
						4SB		0 204 720 420	
1.4 VTi LPG	MFD	06.13→	70			HTB		0 204 720 419	
						4SB		0 204 720 421	
	OFD	06.13→	70			HTB		0 204 720 418	
						4SB		0 204 720 420	
1.6 HDi	MFD	09.09→	66			HTB		0 204 720 419	
						4SB		0 204 720 421	
			82/84			HTB		0 204 720 419	
						4SB	BO	0 204 720 421	
		01.10→	68			HTB	BO	0 204 720 419	
						4SB	BO	0 204 720 421	
		01.12→	55			HTB	BO	0 204 720 419	
						4SB		0 204 720 421	
			68			4SB		0 204 720 421	
		04.14→	73					0 204 720 421	
		09.14→	55					0 204 720 421	
	OFD	09.09→	66			HTB		0 204 720 418	
						4SB		0 204 720 420	
		01.10→	68			HTB	BO	0 204 720 418	
						4SB	BO	0 204 720 420	



												
◀ CITROEN C3 [A51]												
	1.6 HDi	OFD	01.12→	55		HTB	BO	0 204 720 418				
						4SB		0 204 720 420				
				68		4SB		0 204 720 420				
			04.14→	73				0 204 720 420				
			09.14→	55				0 204 720 420				
1.6 HDi	OFD	09.09→	82/84/88			HTB		0 204 720 418				
						4SB		0 204 720 420				
1.6 VTi	MFD	09.09→	88			HTB		0 204 720 419				
						4SB,TW		0 204 720 421				
C3-Pluriel [A42]												
												
	1.4		05.03-06.06	50/54/55	Org.-Nr. →10800		BO	0 204 123 653	22,2			
	1.4 HDi	MFD	05.03-06.06	50/54/55	Org.-Nr. →10800		JBH	LUC	0 986 480 879	22,2		
			05.03-10.12	50/54/55	Org.-Nr. 10801→		JBH		0 986 480 853			
	1.6 16V	MFD	05.03-06.06	80	Org.-Nr. →10800			BO	0 204 123 653	22,2		
05.03-10.12			80	Org.-Nr. 10801→		JBH	LUC	0 986 480 879	22,2			
								0 986 480 853				
	1.4, HDi	OFD	05.03-06.06	50/54/55	Org.-Nr. →10800			BO	0 204 125 820			
	1.6 16V	OFD	05.03-06.06	80	Org.-Nr. →10800			BO	0 204 125 820			
C4 [B5]												
												
	1.4	MFD	11.04-07.07	65	Org.-Nr. →11192				0 204 123 658	23,8		
			08.07-09.10	65	Org.-Nr. 11193→				0 204 123 736	23,81		
			OFD	11.04-07.07	65	Org.-Nr. →11192				0 204 123 597	22,2	
				08.07-09.10	65	Org.-Nr. 11193→			0 204 123 737			
	1.6	MFD	11.04-07.07	80	Org.-Nr. →11192				0 204 123 658	23,8		
			OFD	11.04-07.07	80	Org.-Nr. →11192		AG		0 204 123 596	23,81	
								GS		0 204 123 595	23,81	
				08.07-07.08	80	Org.-Nr. 11193→			0 204 123 737			
	1.6, HDi	MFD	08.07-09.10	80	Org.-Nr. 11193→				0 204 123 736	23,81		
	1.6	MFD	07.08-09.10	88/103/110					0 204 123 736	23,81		
	1.6 THP	OFD	07.08-09.10	88/103/110					0 204 123 737			
	1.6 HDi	MFD	04.10→	80						0 204 123 737		
			11.04-07.07	80	Org.-Nr. →11192		AG		0 204 123 658	23,8		
								GS		0 204 123 746	23,81	
			11.04-07.10	66						0 204 123 658	23,8	
05.07-07.07			66	Org.-Nr. →11192					0 204 123 746	23,81		
08.07-07.09			66	Org.-Nr. 11193→					0 204 123 736	23,81		
OFD			11.04-07.07	80	Org.-Nr. →11192				0 204 123 595	23,81		
			11.04-07.10	66					0 204 123 597	22,2		
			05.07-07.07	66	Org.-Nr. →11192				0 204 123 595	23,81		
			08.07-07.09	66	Org.-Nr. 11193→				0 204 123 737			
			08.07-09.10	80	Org.-Nr. 11193→				0 204 123 737			
1.6 i BioFlex			MFD	09.07-07.08	80					0 204 123 736	23,81	
	OFD	09.07-07.08	80					0 204 123 737				
2.0			11.04-10.05	100					0 204 123 658	23,8		
			11.04-07.07	103	Org.-Nr. →11192, Get.-Nr. MC Manual				0 204 123 746	23,81		
					Org.-Nr. →11192, Get.-Nr. MC Manual				0 204 123 658	23,8		
			08.07-07.08	103	Org.-Nr. 11193→				0 204 123 736	23,81		
2.0 HDi			11.04-07.07	100	Org.-Nr. →11192, Get.-Nr. MC Manual				0 204 123 746	23,81		
					Org.-Nr. →11192, Get.-Nr. MC Manual				0 204 123 658	23,8		
			08.07-01.10	100	Org.-Nr. 11193→				0 204 123 736	23,81		
			07.08-09.10	103				0 204 123 736	23,81			
	1.4	MFD	11.04-07.07	65	Org.-Nr. →11192				0 204 125 823			
				08.08-09.10	65	Org.-Nr. 11585→				0 204 125 902		
			OFD	11.04-07.07	65	Org.-Nr. →11192					0 204 125 776	
					08.08-09.10	65	Org.-Nr. 11585→				0 204 125 901	

		S								
1.6	MFD	11.04-07.07	80	Org.-Nr. →11192 88			0 204 125 823			
	OFD	11.04-07.07	80	Org.-Nr. →11192 88			0 204 125 777			
1.6	MFD	07.08-09.10	88/103/110				0 204 125 902			
1.6 THP	OFD	07.08-09.10	88/103/110				0 204 125 901			
1.6 HDi	MFD	11.04-07.07	80	Org.-Nr. →11192			0 204 125 823			
		11.04-07.10	66				0 204 125 823			
		08.08-07.09	66	Org.-Nr. 11585→			0 204 125 902			
		08.08-09.10	80	Org.-Nr. 11585→			0 204 125 902			
	OFD	11.04-07.07	80	Org.-Nr. →11192			0 204 125 777			
		11.04-07.10	66				0 204 125 776			
		05.07-07.07	66	Org.-Nr. →11192			0 204 125 777			
		08.08-07.09	66	Org.-Nr. 11585→			0 204 125 901			
		08.08-09.10	80	Org.-Nr. 11585→			0 204 125 901			
	2.0		11.04-10.05	100				0 204 125 823		
MFD		11.04-07.07	103	Org.-Nr. →11192			0 204 125 823			
OFD		11.04-07.07	103	Org.-Nr. →11192			0 204 125 777			
2.0 HDi		11.04-07.07	100	Org.-Nr. →11192			0 204 125 823			
		08.08-01.10	100	Org.-Nr. 11585→			0 204 125 902			
		08.08-09.10	103	Org.-Nr. 11585→			0 204 125 902			
	2.0 HDi	04.09-09.10	100/103	Org.-Nr. 11792→			0 986 486 616	19		
	1.4	11.04-09.10	65		B80		0 265 231 487 ^B			
					B80,TW		0 265 234 145 ^T			
	1.6	11.04-09.10	80/88		B80,TW		0 265 234 145 ^T			
	1.6 HDi, i BioFlex	11.04→	80/88		B80		0 265 231 487 ^B			
	1.6 HDi	11.04-07.10	66				0 265 231 487 ^B			
						TW		0 265 234 145 ^T		
		05.07-07.09	66			B80		0 265 231 487 ^B		
						B80,TW		0 265 234 145 ^T		
	1.6 THP	07.08-09.10	103/110		B80		0 265 231 487 ^B			
	2.0	11.04-10.05	100				0 265 231 487 ^B			
						TW		0 265 234 145 ^T		
	2.0	11.04-09.10	103		B80		0 265 231 487 ^B			
	2.0 HDi				B80,TW		0 265 234 145 ^T			
	2.0 HDi	11.04-01.10	100		B80		0 265 231 487 ^B			
					B80,TW		0 265 234 145 ^T			
	1.4	11.04-04.06	65	Org.-Nr. →10737			0 265 005 606			
		05.06-09.10	65	Org.-Nr. 10738→			0 265 005 765			
	1.6	11.04-04.06	80	Org.-Nr. →10737			0 265 005 606			
		05.06-07.08	80	Org.-Nr. 10738→			0 265 005 765			
	1.6, THP	07.08-09.10	88/103/110				0 265 005 765			
	1.6 HDi	11.04-04.06	80	Org.-Nr. →10737	GS		0 265 005 606			
		11.04-07.10	66				0 265 005 606			
		11.04→	80		SEG		0 265 005 715			
		05.06-09.10	80	Org.-Nr. 10738→	GS		0 265 005 765			
		05.07-07.09	66				0 265 005 765			
		04.10→	80		GS		0 265 005 765			
		1.6 i BioFlex	09.07-07.08	80				0 265 005 765		
	2.0	11.04-10.05	100				0 265 005 606			
		11.04-04.06	103	Org.-Nr. →10737			0 265 005 606			
		05.06-07.08	103	Org.-Nr. 10738→			0 265 005 765			
		2.0 HDi	11.04-04.06	100	Org.-Nr. →10737			0 265 005 606		
			05.06-01.10	100	Org.-Nr. 10738→			0 265 005 765		
	07.08-09.10	103				0 265 005 765				



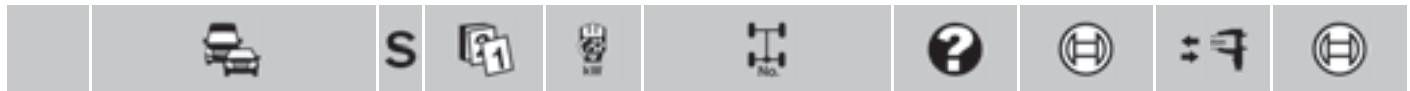

◀ CITROEN

C4 [B71]



	1.2 THP	01.15→	81		0 204 709 705	23,81
		MFD 01.14→	96		0 204 709 705	23,81
		OFD 01.14→	96		0 204 709 703	23,81
	1.4 VTi	09.10→	70		0 204 709 703	23,81
	1.6 BlueHDi	04.14→	73		0 204 709 705	23,81
			85		0 204 709 705	23,81
			88		0 204 709 705	23,81
	1.6 HDi	MFD 09.10→	68/82/84		0 204 709 705	23,81
	1.6 HDi, LPG, VTi	OFD 09.10→	68/82/84/88		0 204 709 703	23,81
	1.6 LPG, VTi	MFD 09.10→	88		0 204 709 705	23,81
	1.6 THP	09.10→	115		0 204 709 705	23,81
	1.6 16V	11.10→	80		0 204 709 703	23,81
	2.0	07.11→	103		0 204 709 703	23,81
2.0 BlueHDi, HDi	09.10→	110		0 204 709 705	23,81	

	1.2 THP	01.15→	81		0 204 709 701	
			96		0 204 709 701	
		MFD 01.14→	96		0 204 709 701	
		OFD 01.14→	96		0 204 709 700	
	1.4 VTi	09.10→	70		0 204 709 700	
	1.6 BlueHDi	04.14→	73		0 204 709 701	
			85		0 204 709 701	
			88		0 204 709 701	
	1.6 HDi	MFD 09.10→	68/82/84		0 204 709 701	
	1.6 HDi, LPG, VTi	OFD 09.10→	68/82/84/88		0 204 709 700	
	1.6 LPG, VTi	MFD 09.10→	88		0 204 709 701	
	1.6 THP	09.10→	115		0 204 709 701	
	1.6 16V	11.10→	80		0 204 709 700	
2.0	07.11→	103		0 204 709 700		
2.0 HDi	09.10→	110		0 204 709 701		

	1.2 THP	01.14→	81/96		0 265 005 765	
	1.4 VTi	09.10→	70		0 265 005 765	
	1.6 BlueHDi, HDi, LPG, THP, VTi, 16V	09.10→	68/73/80/82/84/85/88/115		0 265 005 765	
	2.0, BlueHDi, HDi	09.10→	103/110		0 265 005 765	

C4 Cactus [E3]















	1.2	02.14→	55	JBH	0 986 480 853	
		01.15→	55	HTB,JBH	0 986 480 853	
	1.2, VTi	02.14→	60	JBH	0 986 480 853	
	1.6 HDi	02.14→	68	JBH	0 986 480 853	

C4 Coupé [B5]



	1.4	MFD 11.04-07.07	65	Org.-Nr. →11192		0 204 123 658	23,8
			65	Org.-Nr. 11193→		0 204 123 736	23,81
		OFD 11.04-07.07	65	Org.-Nr. →11192		0 204 123 597	22,2
			65	Org.-Nr. 11193→		0 204 123 737	
	1.6	MFD 11.04-07.07	80	Org.-Nr. →11192		0 204 123 658	23,8
		OFD 11.04-07.07	80	Org.-Nr. →11192	AG	0 204 123 596	23,81
					GS	0 204 123 595	23,81
	1.6	MFD 08.07-07.10	80	Org.-Nr. 11193→		0 204 123 736	23,81
	1.6 HDi	OFD 08.07-07.10	80	Org.-Nr. 11193→		0 204 123 737	
	1.6	MFD 07.08-07.10	88/110			0 204 123 736	23,81
1.6 THP	OFD 07.08-07.10	88/110			0 204 123 737		

										
1.6 HDi	MFD	11.04-07.07	80	Org.-Nr. →11192	AG		0 204 123 658	23,8		
					GS		0 204 123 746	23,81		
		11.04-07.10	66				0 204 123 658	23,8		
		05.07-07.07	66	Org.-Nr. →11192			0 204 123 746	23,81		
		08.07-07.09	66	Org.-Nr. 11193→			0 204 123 736	23,81		
	OFD	11.04-07.07	80	Org.-Nr. →11192			0 204 123 595	23,81		
		11.04-07.10	66				0 204 123 597	22,2		
		05.07-07.07	66	Org.-Nr. →11192			0 204 123 595	23,81		
08.07-07.09		66	Org.-Nr. 11193→			0 204 123 737				
2.0		11.04-10.05	100				0 204 123 658	23,8		
		11.04-07.07	103	Org.-Nr. →11192, Get.-Nr. MC Manual			0 204 123 746	23,81		
				Org.-Nr. →11192, Get.-Nr. MC Manual			0 204 123 658	23,8		
			130	Org.-Nr. →11192			0 204 123 658	23,8		
		08.07-03.08	130	Org.-Nr. 11193→			0 204 123 736	23,81		
2.0 HDi		08.07-07.08	103	Org.-Nr. 11193→			0 204 123 736	23,81		
	MFD	11.04-07.07	100	Org.-Nr. →11192, Get.-Nr. MC Manual			0 204 123 746	23,81		
					Org.-Nr. →11192, Get.-Nr. MC Manual			0 204 123 658	23,8	
	08.07-07.09	100	Org.-Nr. 11193→			0 204 123 736	23,81			
		07.08-07.10	103				0 204 123 736	23,81		
 1.4	MFD	11.04-07.07	65	Org.-Nr. →11192			0 204 125 823			
			08.08-07.10	65	Org.-Nr. 11585→			0 204 125 902		
	OFD	11.04-07.07	65	Org.-Nr. →11192			0 204 125 776			
			08.08-07.10	65	Org.-Nr. 11585→			0 204 125 901		
1.6	MFD	11.04-07.07	80	Org.-Nr. →11192 88			0 204 125 823			
	OFD	11.04-07.07	80	Org.-Nr. →11192 88			0 204 125 777			
1.6	MFD	07.08-07.10	88/110				0 204 125 902			
1.6 THP	OFD	07.08-07.10	88/110				0 204 125 901			
1.6 HDi	MFD	11.04-07.07	80	Org.-Nr. →11192			0 204 125 823			
			11.04-07.10	66				0 204 125 823		
			08.08-07.09	66	Org.-Nr. 11585→			0 204 125 902		
			08.08-07.10	80	Org.-Nr. 11585→			0 204 125 902		
	OFD	11.04-07.07	80	Org.-Nr. →11192			0 204 125 777			
			11.04-07.10	66				0 204 125 776		
			05.07-07.07	66	Org.-Nr. →11192			0 204 125 777		
			08.08-07.09	66	Org.-Nr. 11585→			0 204 125 901		
		08.08-07.10	80	Org.-Nr. 11585→			0 204 125 901			
	2.0		11.04-10.05	100				0 204 125 823		
			11.04-07.07	130	Org.-Nr. →11192			0 204 125 823		
		MFD	11.04-07.07	103	Org.-Nr. →11192			0 204 125 823		
OFD		11.04-07.07	103	Org.-Nr. →11192			0 204 125 777			
2.0 HDi		11.04-07.07	100	Org.-Nr. →11192			0 204 125 823			
		08.08-07.09	100	Org.-Nr. 11585→			0 204 125 902			
		08.08-07.10	103	Org.-Nr. 11585→			0 204 125 902			
 2.0 HDi		04.09-07.10	100/103	Org.-Nr. 11792→			0 986 486 616	19		
 1.4		11.04-07.10	65		B80		0 265 231 487 ^B			
					B80,TW		0 265 234 145 ^T			
	1.6		11.04-07.10	80/88		B80		0 265 231 487 ^B		
		1.6 HDi				B80,TW		0 265 234 145 ^T		
	1.6 HDi		11.04-07.10	66				0 265 231 487 ^B		
						TW		0 265 234 145 ^T		
		05.07-07.09	66		B80		0 265 231 487 ^B			
					B80,TW		0 265 234 145 ^T			
	1.6 THP		07.08-07.10	110		B80		0 265 231 487 ^B		
	2.0		11.04-10.05	100				0 265 231 487 ^B		
						TW		0 265 234 145 ^T		
	2.0		11.04-07.10	103/130		B80		0 265 231 487 ^B		
2.0 HDi					B80,TW		0 265 234 145 ^T			

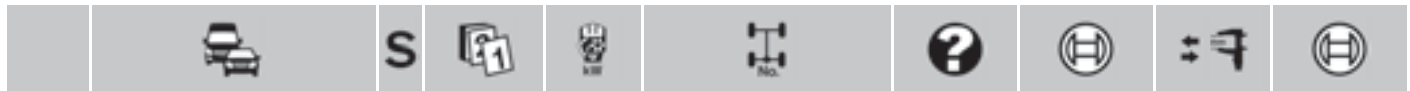

	◀ CITROEN C4 Coupé [B5]					
	2.0 HDi	11.04-07.09	100		B80	0 265 231 487 ^B
					B80,TW	0 265 234 145 ^T

	1.4	11.04-04.06	65	Org.-Nr. →10737		0 265 005 606
		05.06-07.10	65	Org.-Nr. 10738→		0 265 005 765
	1.6	11.04-04.06	80	Org.-Nr. →10737		0 265 005 606
		05.06-07.08	80	Org.-Nr. 10738→		0 265 005 765
	1.6, THP	07.08-07.10	88/110			0 265 005 765
	1.6 HDi	11.04-04.06	80	Org.-Nr. →10737	GS	0 265 005 606
		11.04-07.10	66			0 265 005 606
			80		SEG	0 265 005 715
		05.06-07.10	80	Org.-Nr. 10738→	GS	0 265 005 765
		05.07-07.09	66			0 265 005 765
	2.0	11.04-10.05	100			0 265 005 606
		11.04-04.06	103	Org.-Nr. →10737		0 265 005 606
			130	Org.-Nr. →10737		0 265 005 606
		05.06-03.08	130	Org.-Nr. 10738→		0 265 005 765
		05.06-07.08	103	Org.-Nr. 10738→		0 265 005 765
	2.0 HDi	11.04-04.06	100	Org.-Nr. →10737		0 265 005 606
		05.06-07.09	100	Org.-Nr. 10738→		0 265 005 765
		07.08-07.10	103			0 265 005 765

C4 Grand Picasso [B58]

	1.6	07.08→	88			0 986 486 616	
		1.6 HDi	10.06-12.11	80	GS	0 986 486 616	
		1.8	10.06-07.08	92		0 986 486 616	
	1.6 HDi	10.06-12.11	80		TW	0 265 230 478 ^T	
		1.8	10.06-07.08	92		TW	0 265 230 478 ^T
		2.0, HDi	10.06-12.11	100/103		TW	0 265 230 478 ^T

	1.6	07.08-11.08	88	Org.-Nr. →11682		0 265 005 715
		12.08-04.10	88	Org.-Nr. 11683→		0 265 005 765
		04.10→	88			0 265 005 765
	1.6 HDi	10.06-11.08	80	Org.-Nr. →11682		0 265 005 715
		12.08-12.11	80	Org.-Nr. 11683→		0 265 005 765
		05.10→	82			0 265 005 765
	1.6 THP	07.08-11.08	103/110	Org.-Nr. →11682		0 265 005 715
		12.08-12.11	103/110	Org.-Nr. 11683→		0 265 005 765
		03.10→	115			0 265 005 765
	1.8	10.06-07.08	92			0 265 005 715
	2.0	10.06-10.08	103			0 265 005 715
	2.0 HDi	10.06-11.08	100	Org.-Nr. →11682		0 265 005 715
		12.08-12.11	100	Org.-Nr. 11683→		0 265 005 765
		07.09→	110/120			0 265 005 765

C4 Picasso [B58]

	1.6	07.08→	88			0 986 486 616	
		1.6 HDi	02.07-12.11	80	GS	0 986 486 616	
		1.8	02.07-12.11	92		0 986 486 616	
	1.6 HDi	02.07-12.11	80		TW	0 265 230 478 ^T	
		1.8	02.07-12.11	92		TW	0 265 230 478 ^T
		2.0, HDi	02.07-12.11	100/103		TW	0 265 230 478 ^T
	1.6	07.08-11.08	88	Org.-Nr. →11682		0 265 005 715	
		12.08-04.10	88	Org.-Nr. 11683→		0 265 005 765	
		04.10→	88			0 265 005 765	

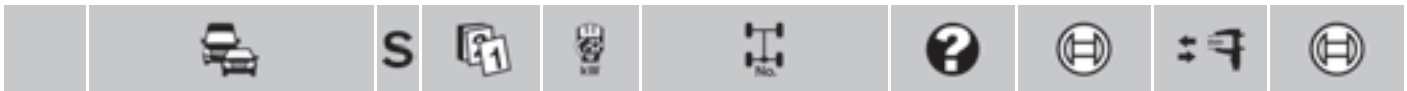

1.6 HDi	02.07-11.08	80	Org.-Nr. →11682	0 265 005 715
	12.08-12.11	80	Org.-Nr. 11683→	0 265 005 765
	05.10→	82		0 265 005 765
1.6 THP	07.08-11.08	103/110	Org.-Nr. →11682	0 265 005 715
	12.08-12.11	103/110	Org.-Nr. 11683→	0 265 005 765
	03.10→	115		0 265 005 765
1.8	02.07-12.11	92		0 265 005 715
2.0	02.07-10.08	103		0 265 005 715
2.0 HDi	02.07-11.08	100	Org.-Nr. →11682	0 265 005 715
	12.08-12.11	100	Org.-Nr. 11683→	0 265 005 765
	07.09→	110/120		0 265 005 765

C4 Sedan [B5]



















	1.6	MFD	07.06-12.10	80	Org.-Nr. →11192 88, →11346 77, →11241 UW	0 204 123 658	23,8	
						Org.-Nr. 11347 77→, 11242 UW→, 11193 88→	0 204 123 736	23,81
			07.06-12.10	80	Org.-Nr. →11241 UW, GS →11192 88, →11346 77	0 204 123 595	23,81	
						Org.-Nr. →11346 77, AG →11192 88, →11241 UW	0 204 123 596	23,81
					Org.-Nr. 11347 77→, 11242 UW→, 11193 88→	0 204 123 737		
1.6 HDi	MFD	04.10→	80		0 204 123 737			
		07.06-12.07	80	Org.-Nr. →11346 77, Get.-Nr. MC Manual	0 204 123 746	23,81		
					Org.-Nr. →11346 77, Get.-Nr. MC Manual	0 204 123 658	23,8	
		08.07-12.10	80	Org.-Nr. 11193 88→	0 204 123 736	23,81		
		07.06-07.07	80	Org.-Nr. →11192 88	0 204 123 595	23,81		
		07.06-12.07	80	Org.-Nr. →11346 77 TW	0 204 123 595	23,81		
					0 204 123 596	23,81		
		08.07-12.10	80	Org.-Nr. 11193 88→	0 204 123 737			
		2.0	MFD	07.06-07.07	103	Org.-Nr. →11192 88, Get.-Nr. MC Manual	0 204 123 746	23,81
							Org.-Nr. →11192 88, Get.-Nr. MC Manual	0 204 123 658
08.07-12.10	103			Org.-Nr. 11193 88→	0 204 123 736	23,81		
07.06-12.07	103			Org.-Nr. →11346 77	0 204 123 746	23,81		
09.07-12.10	103			Org.-Nr. 11242 UW→	0 204 123 736	23,81		
07.06-08.07	103			Org.-Nr. →11241 UW	AG	0 204 123 596	23,81	
					GS	0 204 123 595	23,81	
					AG	0 204 123 596	23,81	
			GS	0 204 123 595	23,81			
09.07-12.10	103	Org.-Nr. 11242 UW→	0 204 123 737					
2.0 HDi	MFD	07.06-12.10	80		0 204 123 595	23,81		



1.6	MFD	07.06-07.07	80	Org.-Nr. →11192 88	0 204 125 823
		07.06-08.07	80	Org.-Nr. →11241 UW	0 204 125 823
		07.06-12.07	80	Org.-Nr. →11346 77	0 204 125 823
1.6	OFD	07.06-07.07	80	Org.-Nr. →11192 88	0 204 125 777
		07.06-08.07	80	Org.-Nr. →11241 UW	0 204 125 777
		07.06-12.07	80	Org.-Nr. →11346 77	0 204 125 777
1.6 HDi	MFD	08.08-12.10	80	Org.-Nr. 11585 88→	0 204 125 902
1.6 HDi	OFD	08.08-12.10	80	Org.-Nr. 11585 88→	0 204 125 901
1.6 HDi	MFD	07.06-07.07	80	Org.-Nr. →11192 88	0 204 125 823
		07.06-12.07	80	Org.-Nr. →11346 77	0 204 125 823
		07.06-07.07	80	Org.-Nr. →11192 88	0 204 125 777
1.6 HDi	OFD	07.06-12.07	80	Org.-Nr. →11346 77	0 204 125 777
		07.06-07.07	80	Org.-Nr. →11192 88	0 204 125 777
		07.06-12.07	80	Org.-Nr. →11346 77	0 204 125 777
2.0	MFD	07.06-07.07	103	Org.-Nr. →11192 88	0 204 125 823
		08.08-12.10	103	Org.-Nr. 11585 88→	0 204 125 902
		07.06-08.07	103	Org.-Nr. →11241 UW	0 204 125 823
		07.06-12.07	103	Org.-Nr. →11346 77	0 204 125 823
		07.06-08.07	103	Org.-Nr. →11241 UW	0 204 125 777
	OFD	07.06-12.07	103	Org.-Nr. →11346 77	0 204 125 777



		S							
CITROEN C4 Sedan [B5]									
	2.0 HDi	07.06-12.10	80				0 204 125 777		
	1.6	07.06-12.10	80	Org.-Nr. 11221 77→	B81		0 265 232 088 ^B		
	1.6, HDi	07.06-12.10	80	Org.-Nr. 10647 UW→	B80		0 265 234 461 ^T		
	1.6 HDi	07.06-12.10	80	Org.-Nr. 11221 77→	B81		0 265 232 088 ^B		
		04.10→	80		B81		0 265 232 088 ^B		
	2.0	07.06-12.10	80/103	Org.-Nr. 10647 UW→	B80		0 265 234 461 ^T		
	2.0 HDi			Org.-Nr. 11221 77→	B81		0 265 232 088 ^B		
	1.6, HDi	07.06→	80				0 265 005 765		
	2.0, HDi	07.06-12.10	80/103				0 265 005 765		
C5 Break [X3]									
	1.6 HDi	10.04-03.08	80				0 204 123 584	22	
	1.8 i	10.04-03.08	85/92				0 204 123 584	22	
	2.0 HDi, i	10.04-03.08	93-100/103				0 204 123 584	22	
	2.2 HDi	10.04-09.05	98				0 204 123 584	22	
		04.06-03.08	120-125				0 204 123 584	22	
	3.0 i	10.04-04.07	155				0 204 123 584	22	
	1.6 HDi	10.04-03.08	80		LLE		0 204 125 748		
					RLE		0 204 125 749		
	1.8 i	10.04-03.08	85/92		LLE		0 204 125 748		
					RLE		0 204 125 749		
	2.0 HDi	10.04-03.08	93-100/		LLE		0 204 125 748		
	2.0 i		103		RLE		0 204 125 749		
	2.2 HDi	10.04-09.05	98		LLE		0 204 125 748		
					RLE		0 204 125 749		
		04.06-03.08	120-125		LLE		0 204 125 748		
					RLE		0 204 125 749		
	3.0 i	10.04-04.07	155		LLE		0 204 125 748		
					RLE		0 204 125 749		
C5 Break [X4]									
	1.8 i 16V	MFD 06.01-09.04	85				0 204 123 584	22	
		OFD 06.01-09.04	85				0 204 123 546	22	
	2.0 HDi, HPI, i 16V	MFD 06.01-09.04	66/79/80/100/103				0 204 123 584	22	
		OFD 06.01-09.04	66/79/80/100/103				0 204 123 546	22	
	2.2 HDi	MFD 06.01-09.04	98				0 204 123 584	22	
		OFD 06.01-09.04	98				0 204 123 546	22	
	3.0 i	MFD 06.01-09.04	150				0 204 123 584	22	
		OFD 06.01-09.04	150				0 204 123 546	22	
	1.8 i 16V	06.01-09.04	85		LLE		0 204 125 748		
					RLE		0 204 125 749		
	2.0 HDi	06.01-09.04	66/79/80/		LLE		0 204 125 748		
	2.0 i 16V		100		RLE		0 204 125 749		
	2.0 HPI	06.01-09.04	103		LLE		0 204 125 779		
					RLE		0 204 125 780		
	2.2 HDi	06.01-09.04	98		LLE		0 204 125 748		
					RLE		0 204 125 749		
	3.0 i	06.01-09.04	150		LLE		0 204 125 748		
					RLE		0 204 125 749		

		S							
C5 Tourer [X7]									
									
	1.6 HDi	04.08-03.10	80	Org.-Nr. →12165	RLE	0 986 486 616	19		
	1.8	04.08-03.10	92	Org.-Nr. →12165	RLE	0 986 486 616	19		
	2.0	04.08-01.10	103		RLE	0 986 486 616	19		
	2.0 HDi	04.08-03.10	100-103	Org.-Nr. →12165		0 986 486 616	19		
		09.09-03.10	110/120	Org.-Nr. →12165		0 986 486 616	19		
	1.6, HDi, THP	09.09→	82/84/88/110/115/120				0 265 005 765		
	1.6 HDi	04.08-07.10	80		TW	0 265 005 715			
						0 265 005 765			
	1.8	04.08-01.11	92		TW	0 265 005 715			
						0 265 005 765			
	2.0	04.08-01.10	103		TW	0 265 005 715			
						0 265 005 765			
	2.0 BlueHDi, HDi	09.09→	110/120				0 265 005 765		
	2.0 HDi	04.08→	100-103			TW	0 265 005 715		
						0 265 005 765			
		12.10→	100-103				0 265 005 765		
	2.2 HDi	04.08-09.09	120-125			TW	0 265 005 715		
						0 265 005 765			
		07.10→	150				0 265 005 765		
	2.7 HDi	04.08-07.09	150			TW	0 265 005 715		
						0 265 005 765			
	3.0 HDi 24V	07.09→	177				0 265 005 765		
C5 [X3]									
									
	1.6 HDi	10.04-03.08	80			0 204 123 584	22		
	1.8 i	10.04-03.08	85/92			0 204 123 584	22		
	2.0 HDi, i	10.04-03.08	93-100/103				0 204 123 584	22	
	2.2 HDi	10.04-09.05	98			0 204 123 584	22		
		03.06-03.08	120-125				0 204 123 584	22	
	3.0 i	10.04-04.07	155			0 204 123 584	22		
	1.6 HDi	10.04-03.08	80		LLE	0 204 125 748			
					RLE	0 204 125 749			
	1.8 i	10.04-03.08	85/92		LLE	0 204 125 748			
					RLE	0 204 125 749			
	2.0 HDi	10.04-03.08	93-100/			LLE	0 204 125 748		
	2.0 i		103			RLE	0 204 125 749		
	2.2 HDi	10.04-09.05	98		LLE	0 204 125 748			
					RLE	0 204 125 749			
		03.06-03.08	120-125			LLE	0 204 125 748		
					RLE	0 204 125 749			
	3.0 i	10.04-04.07	155		LLE	0 204 125 748			
					RLE	0 204 125 749			
C5 [X4]									
									
	1.8 i 16V	MFD 03.01-09.04	85			0 204 123 584	22		
		OFD 03.01-09.04	85			0 204 123 546	22		
	2.0 HDi, HPI, i 16V	MFD 03.01-09.04	66/79/80/100/103				0 204 123 584	22	
		OFD 03.01-09.04	66/79/80/100/103				0 204 123 546	22	
	2.2 HDi	MFD 03.01-09.04	98			0 204 123 584	22		
		OFD 03.01-09.04	98			0 204 123 546	22		
	3.0 i	MFD 03.01-09.04	150			0 204 123 584	22		
		OFD 03.01-09.04	150			0 204 123 546	22		





◀ CITROEN C5 [X4]

	1.8 i 16V	03.01-09.04	85		LLE	0 204 125 748	
					RLE	0 204 125 749	
	2.0 HDi	03.01-09.04	66/79/80/		LLE	0 204 125 748	
	2.0 i 16V		100		RLE	0 204 125 749	
	2.0 HPi	03.01-09.04	103		LLE	0 204 125 779	
				RLE	0 204 125 780		
	2.2 HDi	03.01-09.04	98		LLE	0 204 125 748	
					RLE	0 204 125 749	
	3.0 i	03.01-09.04	150		LLE	0 204 125 748	
				RLE	0 204 125 749		

C5 [X7]



	1.6 HDi	04.08-03.10	80	Org.-Nr. →12165	RLE	0 986 486 616	19
	1.8	04.08-03.10	92	Org.-Nr. →12165	RLE	0 986 486 616	19
	2.0	04.08-01.10	103		RLE	0 986 486 616	19
	2.0 HDi	04.08-03.10	100-103	Org.-Nr. →12165		0 986 486 616	19
		09.09-03.10	110/120	Org.-Nr. →12165		0 986 486 616	19

	1.6 HDi	04.08-07.10	80		TW	0 265 005 715	
						0 265 005 765	
	1.6 HDi, THP, VTi	09.09→	82/84/88/110/115/120			0 265 005 765	
	1.8	04.08-01.11	92		TW	0 265 005 715	
					0 265 005 765		
	2.0	04.08-01.10	103		TW	0 265 005 715	
					0 265 005 765		
	2.0 BlueHDi, HDi	09.09→	110/120			0 265 005 765	
	2.0 HDi	04.08→	100-103		TW	0 265 005 715	
					0 265 005 765		
				12.10→	100-103		0 265 005 765
	2.2 HDi	04.08-09.09	120-125		TW	0 265 005 715	
					0 265 005 765		
		07.10→	150			0 265 005 765	
	2.7 HDi	04.08-07.09	150		TW	0 265 005 715	
				0 265 005 765			
3.0	04.08-04.09	155		TW	0 265 005 715		
3.0 24V					0 265 005 765		
3.0 HDi 24V	07.09→	177			0 265 005 765		

C6 [X6]

















	2.2 HDi	11.07-07.10	120-125	Org.-Nr. 11284→		0 265 005 765	
	2.7 HDi	11.07-07.09	150	Org.-Nr. 11284→		0 265 005 765	
	3.0	11.07-02.09	155	Org.-Nr. 11284→		0 265 005 765	
	3.0 HDi 24V	07.09→	177			0 265 005 765	

C8 [V3]



	2.0 HDi, 16V	06.02-12.06	81/100			0 204 123 592	22,2
	2.2 HDi, 16V	06.02-07.06	94/116			0 204 123 592	22,2
	2.0 HDi	06.02-12.06	81/100		LLE	0 204 125 792	
	2.0 16V				RLE	0 204 125 791	
	2.2 HDi	06.02-07.06	94/116		LLE	0 204 125 792	
	2.2 16V				RLE	0 204 125 791	

		S								
	2.0 HDi	06.02-10.05	81	Org.-Nr. →10562				0 265 225 166 ^T		
		06.02-12.06	81					0 265 222 010 ^B		
		03.06-05.10	88					0 265 222 010 ^B		
				100/103				0 265 222 010 ^B		
	2.0 16V	06.02-10.05	100/103	Org.-Nr. →10562				0 265 225 166 ^T		
		06.02-05.10	100/103					0 265 222 010 ^B		
	2.2 HDi	06.02-10.05	94/116	Org.-Nr. →10562				0 265 225 166 ^T		
	2.2 16V	06.02-07.06	94/116					0 265 222 010 ^B		
	3.0	10.02-10.05	150	Org.-Nr. →10562				0 265 225 166 ^T		
		10.02-05.06	150					0 265 222 010 ^B		
	2.0 HDi	06.02-10.05	81	Org.-Nr. →10562				0 265 005 290		
		11.05-12.06	81	Org.-Nr. 10563→				0 265 005 606		
		03.06-09.07	88	Org.-Nr. →11256					0 265 005 606	
			100	Org.-Nr. →11256					0 265 005 606	
		10.07-05.10	88	Org.-Nr. 11257→					0 265 005 765	
			100	Org.-Nr. 11257→					0 265 005 765	
		06.10-07.14	100					0 265 005 765		
		120					0 265 005 765			
	2.0 16V	06.02-10.05	100	Org.-Nr. →10562				0 265 005 290		
		10.05-10.05	103	Org.-Nr. →10562				0 265 005 290		
		11.05-05.06	100	Org.-Nr. 10563→				0 265 005 606		
		11.05-09.07	103	Org.-Nr. 10563→11256				0 265 005 606		
		10.07-05.10	103	Org.-Nr. 11257→				0 265 005 765		
	2.2 HDi	09.07-05.10	120-125					0 265 005 765		
	2.2 HDi	06.02-10.05	94/116	Org.-Nr. →10562				0 265 005 290		
	2.2 16V	11.05-07.06	94/116	Org.-Nr. 10563→				0 265 005 606		
	3.0	10.02-10.05	150	Org.-Nr. →10562				0 265 005 290		
	11.05-05.06	150	Org.-Nr. 10563→				0 265 005 606			
DS3 [A5]										
										
	1.6 Blue HDi	01.14→	85					0 204 123 815	23,81	
	1.6 Blue HDi	01.14→	85					0 204 720 421		
DS3 [A55]										
										
	1.2 THP	04.14→	81					0 204 123 815	23,81	
	1.2 VTi	06.12→	60					0 204 123 811	22,2	
	1.4 HDi 8V	03.10→	50					BO	0 204 123 811	22,2
								JBH	TRW	0 986 480 853
	1.4 VTi	01.10-11.11	70-72	Org.-Nr. →12774				BO	0 204 123 815	23,81
	1.4 VTi LPG	01.10→	70-72					JBH	TRW	0 986 480 853
		12.11→	70-72	Org.-Nr. 12775→					BO	0 204 123 811
	1.6 Blue HDi	01.14→	88/110/115						0 204 123 815	23,81
		02.14→	73						0 204 123 815	23,81
	1.6 BlueHDi	09.14→	55						0 204 123 815	23,81
1.6 HDi	11.09→	82/84						BO	0 204 123 815	23,81
	01.10→	68						BO	0 204 123 815	23,81
1.6 THP	01.10→	88/110/115						0 204 123 815	23,81	
	10.11→	88/110/115						BO	0 204 123 815	23,81
	01.12→	120						BO	0 204 123 815	23,81
	04.14→	121						0 204 123 815	23,81	
1.6 THP Racing	10.10→	149/152						BO	0 204 123 815	23,81
1.6 VTi	01.10→	88/110/115						BO	0 204 123 815	23,81





◀ CITROEN DS3 [A55]

	1.2 THP	04.14→	81		0 204 720 421	
	1.2 VTi	06.12→	60		0 204 720 419	
	1.4 HDi 8V	03.10→	50		BO 0 204 720 419	
	1.4 VTi	01.10-11.11	70-72	Org.-Nr. →12774	BO 0 204 720 421	
	1.4 VTi LPG	12.11→	70-72	Org.-Nr. 12775→	BO 0 204 720 419	
	1.6 Blue HDi	01.14→	88/110/115		0 204 720 421	
		02.14→	73		0 204 720 421	
	1.6 Blue HDi	09.14→	55		0 204 720 421	
	1.6 HDi	11.09→	82/84		BO 0 204 720 421	
		01.10→	68		BO 0 204 720 421	
	1.6 THP	01.10→	88/110/115		0 204 720 421	
		10.11→	88/110/115		BO 0 204 720 421	
		01.12→	120		BO 0 204 720 421	
		04.14→	121		0 204 720 421	
	1.6 THP Racing	10.10→	149/152		BO 0 204 720 421	
1.6 VTi	01.10→	88/110/115		BO 0 204 720 421		

DS3 Cabrio [A56]



	1.2 THP	04.14→	81		0 204 123 815	23,81
	1.2 VTi, VTi	07.12→	60		0 204 123 811	22,2
	1.6 Blue HDi	01.14→	88/110		0 204 123 815	23,81
	1.6 Blue HDi, HDi	01.14→	73/85		0 204 123 815	23,81
	1.6 HDi	07.12→	68		BO 0 204 123 815	23,81
		07.12→	115		BO 0 204 123 815	23,81
	1.6 THP	01.13→	88/110		BO 0 204 123 815	23,81
		04.14→	88/110		0 204 123 815	23,81
			121		0 204 123 815	23,81
	1.6 VTi	07.12→	88/110		BO 0 204 123 815	23,81

	1.2 THP	04.14→	81		0 204 720 421	
	1.2 VTi, VTi	07.12→	60		0 204 720 419	
	1.6 Blue HDi	01.14→	88/110		0 204 720 421	
	1.6 Blue HDi, HDi	01.14→	73/85		0 204 720 421	
	1.6 HDi	07.12→	68		BO 0 204 720 421	
		07.12→	115		BO 0 204 720 421	
	1.6 THP	01.13→	88/110		BO 0 204 720 421	
		04.14→	88/110		0 204 720 421	
			121		0 204 720 421	
	1.6 VTi	07.12→	88/110		BO 0 204 720 421	

DS4 [B75]

















	1.2 THP	MFD 01.14→	96		0 204 709 705	23,81
		OFD 01.14→	96		0 204 709 703	23,81
	1.6 Blue HDi, HDi	04.14→	73/85		0 204 709 705	23,81
	1.6 HDi	04.14→	88		0 204 709 705	23,81
	1.6 HDi, HDi 16V	MFD 03.11→	68/82/84		0 204 709 705	23,81
	1.6 HDi, HDi 16V, VTi	OFD 03.11→	68/82/84/88		0 204 709 703	23,81
	1.6 THP	03.11→	110/115/120/121		0 204 709 705	23,81
			147		0 204 718 072	
	1.6 VTi	MFD 03.11→	88		0 204 709 705	23,81
	2.0 Blue HDi, HDi, HDi 16V	03.11→	100/110/120/133		0 204 709 705	23,81

	1.2 THP	MFD 01.14→	96		0 204 709 701	
		OFD 01.14→	96		0 204 709 700	
	1.6 Blue HDi, HDi	04.14→	73/85		0 204 709 701	
	1.6 HDi	04.14→	88		0 204 709 701	
	1.6 HDi, HDi 16V	MFD 03.11→	68/82/84		0 204 709 701	
	1.6 HDi, HDi 16V, VTi	OFD 03.11→	68/82/84/88		0 204 709 700	

		S							
1.6 THP		03.11→		110/115/120/121					0 204 709 701
				147					0 204 718 070
1.6 VTi		MFD 03.11→		88					0 204 709 701
2.0 HDi, HDi 16V		03.11→		100/120					0 204 709 701
1.2 THP		01.14→		96					0 265 005 765
1.6 HDi, HDi 16V, THP, VTi		03.11→		68/82/84/85/88/110/115/120/121/147					0 265 005 765
2.0 BlueHDi, HDi, HDi 16V		03.11→		100/120/133					0 265 005 765
DS5 [B81]									
1.6 Blue HDi, HDi, THP		09.11→		82/84/85/88/110/115/120-121/147					0 265 005 765
2.0 Blue HDi, BlueHDi, BlueHDi, HDi, HDi HYbrid4 4x4		09.11→		100/110/120-147					0 265 005 765
Evasion [U60]									
1.8 i		ABO 09.96-07.02	72-74						0 204 124 059⁶
						JBH	F 026 003 188	22,2	
		ABS 09.96-07.02	72-74						0 204 124 136⁶
						JBH	F 026 003 518	22,2	
1.9 D Turbo		ABO 10.94-05.99	66/67-68	Org.-Nr. →8206					0 204 124 073⁶
						JBH	F 026 003 166	23,8	
		06.99-07.02	66/67-68	Org.-Nr. 8207→		JBH	F 026 003 517	23,81	
		ABS 10.94-05.99	66/67-68	Org.-Nr. →8206					0 204 123 182
						JBH	F 026 003 516	23,81	
		06.99-07.02	66/67-68	Org.-Nr. 8207→		JBH	F 026 003 516	23,81	
2.0 HDi		ABO 01.99-07.02	80/81			JBH	F 026 003 517	23,81	
		ABS 01.99-07.02	80/81			JBH	F 026 003 516	23,81	
2.0 i Turbo		ABO 06.94-05.99	108-110	Org.-Nr. →8206					0 204 124 073⁶
						JBH	F 026 003 166	23,8	
						JBH	F 026 003 517	23,81	
		ABS 06.94-05.99	108-110	Org.-Nr. →8206					0 204 123 182
						JBH	F 026 003 516	23,81	
		06.99-07.02	108-110	Org.-Nr. 8207→		JBH	F 026 003 516	23,81	
2.0 i		ABO 06.94-05.99	89-90/97-99	Org.-Nr. →8206					0 204 124 073⁶
2.0 i 16V						JBH	F 026 003 166	23,8	
						JBH	F 026 003 517	23,81	
		ABS 06.94-05.99	89-90/97-99	Org.-Nr. →8206					0 204 123 182
						JBH	F 026 003 516	23,81	
		06.99-07.02	89-90/97-99	Org.-Nr. 8207→		JBH	F 026 003 516	23,81	
2.0 i 16V		ABO 04.00-07.02	100			JBH	F 026 003 517	23,81	
		ABS 04.00-07.02	100			JBH	F 026 003 516	23,81	
2.1 D Turbo		ABO 04.96-05.99	80-81	Org.-Nr. →8206					0 204 124 073⁶
						JBH	F 026 003 166	23,8	
						JBH	F 026 003 517	23,81	
		ABS 04.96-05.99	80-81	Org.-Nr. →8206					0 204 123 182
						JBH	F 026 003 516	23,81	
		06.99-07.02	80-81	Org.-Nr. 8207→		JBH	F 026 003 516	23,81	
1.8 i		09.96-07.02	72-74						0 204 125 716
1.9 D Turbo		10.94-07.02	66/67-68			LLE	0 204 125 715		
						RLE	0 204 125 109		
2.0 HDi		06.94-07.02	80/81/			LLE	0 204 125 715		
2.0 i			89-90			RLE	0 204 125 109		
2.0 i Turbo		06.94-07.02	108-110				0 204 125 714		
2.0 i 16V		05.98-04.00	97-99				0 204 125 714		
		04.00-07.02	100			LLE	0 204 125 715		
						RLE	0 204 125 109		
2.1 D Turbo		04.96-07.02	80-81				0 204 125 715		



◀ CITROEN Evasion [U60]										
	1.8 i		09.96-07.02	72-74			0 204 131 085 ^A			
	1.9 D Turbo		10.94-07.02	66/67-68			0 204 131 084 ^A			
	2.0 HDi, i		06.94-07.02	80/89-90			0 204 131 084 ^A			
	2.0 i Turbo, i 16V		06.94-07.02	97-99/108-110			0 204 131 082 ^A			
	2.1 D Turbo		04.96-07.02	80-81			0 204 131 084 ^A			
	1.8 i		06.97-05.99	72-74	Org.-Nr. 7481→8420		0 265 216 496 ^B			
			06.99-07.02	72-74	Org.-Nr. 8421→		0 265 216 725 ^B			
	1.9 D Turbo		06.97-05.99	66/67-68	Org.-Nr. 7481→8420		0 265 216 496 ^B			
			06.99-07.02	66/67-68	Org.-Nr. 8421→		0 265 216 725 ^B			
	2.0 HDi		01.99-05.99	80	Org.-Nr. →8420		0 265 216 496 ^B			
			06.99-07.02	80	Org.-Nr. 8421→		0 265 216 725 ^B			
			06.00-07.02	81	Org.-Nr. 8421→		0 265 216 725 ^B			
	2.0 i		06.97-05.99	89-90	Org.-Nr. 7481→8420		0 265 216 496 ^B			
			06.99-07.02	89-90	Org.-Nr. 8421→		0 265 216 725 ^B			
	2.0 i Turbo		06.97-05.99	108-110	Org.-Nr. 7481→8420		0 265 216 496 ^B			
			06.99-07.02	108-110	Org.-Nr. 8421→		0 265 216 725 ^B			
	2.0 i 16V		05.98-05.99	97-99	Org.-Nr. →8420		0 265 216 496 ^B			
			06.99-04.00	97-99	Org.-Nr. 8421→		0 265 216 725 ^B			
			04.00-07.02	100			0 265 216 725 ^B			
	2.1 D Turbo		06.97-05.99	80-81	Org.-Nr. 7481→8420		0 265 216 496 ^B			
		06.99-07.02	80-81	Org.-Nr. 8421→		0 265 216 725 ^B				
Jumper										
	2.8 HDi	ABO	12.01-09.09	77/93		KL	0 204 123 616	25,4		
	2.8 T					JBH,L02,LLE	F 026 003 313	25,4		
		ABS	12.01-09.09	77/93			KL	0 204 123 615	25,4	
	2.8 HDi		12.01-09.09	77/93			0 204 125 801			
	2.8 T				Fg.-Nr. →15064995	L03	0 204 125 445			
					Fg.-Nr. 15064996→15984271	L03	0 204 125 746			
					Fg.-Nr. 15984272→		0 204 125 772			
	2.8 HDi		12.01-09.09	77/93	Fg.-Nr. 15445358→	L02	0 265 216 530 ^B			
	2.8 T					L03	0 265 216 436 ^B			
Jumper [U5]										
	2.0 HDi	ABO	02.02-05.06	62/80		KL	0 204 123 616	25,4		
	2.0 i	ABS	02.02-05.06	62/80		KL	0 204 123 615	25,4		
	2.2 HDi	ABO	02.02-05.06	74		KL	0 204 123 616	25,4		
		ABS	02.02-05.06	74		KL	0 204 123 615	25,4		
	2.3 HDi	ABO	02.02-05.06	81			0 204 123 616	25,4		
		ABS	02.02-05.06	81			0 204 123 615	25,4		
	2.8 D Turbo	ABO	02.02-05.06	90/94/107		KL	0 204 123 616	25,4		
	2.8 HDi	ABS	02.02-05.06	90/94/107		KL	0 204 123 615	25,4		
		2.0 HDi, i		02.02-05.06	62/80			0 204 125 801		
		2.2 HDi		02.02-05.06	74			0 204 125 801		
2.3 HDi			02.02-05.06	81			0 204 125 801			
2.8 D Turbo, HDi			02.02-05.06	90/94/107			0 204 125 801			
	2.0 HDi		02.02-05.06	62/80		AA,FEN, TW	0 204 031 182 ^A			
	2.0 i						0 204 031 183 ^A			
							0 204 031 185 ^A			
						AA,FEV,L02	0 204 031 202 ^A			
						AA,FEV,L03	0 204 031 184 ^A			
		ABO	02.02-05.06	62/80		AA	0 204 131 232			

															
2.2 HDi		02.02-05.06	74				AA,FEN,	0 204 031 182 ^A							
							TW	0 204 031 183 ^A							
								0 204 031 185 ^A							
							AA,FEV,L02	0 204 031 202 ^A							
							AA,FEV,L03	0 204 031 184 ^A							
2.3 HDi		02.02-05.06	81				AA	0 204 131 232							
							FGN,L02	0 204 031 185 ^A							
							FGN,L07	0 204 031 183 ^A							
							L02,VFG	0 204 031 202 ^A							
							L06	0 204 031 182 ^A							
							L07,VFG	0 204 031 184 ^A							
2.8 D Turbo 2.8 HDi		02.02-05.06	90/94/107				AA,FEN,	0 204 031 182 ^A							
							TW	0 204 031 183 ^A							
								0 204 031 185 ^A							
							AA,FEV,L02	0 204 031 202 ^A							
							AA,FEV,L03	0 204 031 184 ^A							
		ABO 02.02-05.06	90/94/107				AA	0 204 131 232							
Jumper [U6]															
															
	3.0 HDi	MFD 03.11→	130				2X6,G12,L07	0 204 123 721	26,9						
							2X8,G12,L20	0 204 123 719	25,4						
		OFD 03.11→	130					2X6,G10,L07	0 204 123 718	25,4					
								2X8,G10,L20	0 204 123 720	26,9					
Jumper [U9]															
															
	2.2 HDi	MFD 06.06→	74/81/88/ 95/96/110				2X6,G12,L07	0 204 123 721	26,9						
							2X8,G12,L20	0 204 123 719	25,4						
		OFD 06.06→	74/81/88/ 95/96/110					2X6,G10,L07	0 204 123 718	25,4					
								2X8,G10,L20	0 204 123 720	26,9					
		3.0 HDi	MFD 06.06→	107/115/ 116				2X6,G12,L07	0 204 123 721	26,9					
								2X8,G12,L20	0 204 123 719	25,4					
		OFD 06.06→	107/115/ 116				2X6,G10,L07	0 204 123 718	25,4						
							2X8,G10,L20	0 204 123 720	26,9						
Jumper [23]															
															
	1.9 D, D Turbo 2.0 2.0i 2.0 HDi 2.5 D, D Turbo	ABO 02.94-12.94	51/66-68				JBH,L03,LL	F 026 003 318	22,2						
							L03,RLE	0 204 123 319	22,2						
							02.94-02.02	51/66-68			JBH,L02,LL	F 026 003 313	25,4		
								L02,RLE	0 204 123 314	25,4					
				01.95-02.02	51/66-68			L03,RLE	0 204 123 325	23,8					
		ABS	02.94-12.94	51/66-68					L03	0 204 123 320	22,2				
									02.94-02.02	51/66-68				F 026 003 315	25,4
		2.0 2.0i	ABO 02.94-12.94	79/80					JBH,L03,LL	F 026 003 318	22,2				
									L03,RLE	0 204 123 319	22,2				
									02.94-02.02	79/80			JBH,L02,LL	F 026 003 313	25,4
													L02,RLE	0 204 123 314	25,4
											01.95-02.02	79/80			L03,RLE
		ABS	02.94-12.94	79/80					L03	0 204 123 320	22,2				
									02.94-02.02	79/80				F 026 003 315	25,4
		2.0 HDi	ABO 03.01-02.02	62					JBH,L02,LL	F 026 003 313	25,4				
L02,RLE	0 204 123 314								25,4						
L03,RLE	0 204 123 325								23,8						
		ABS 03.01-02.02	62				F 026 003 315	25,4							
2.5 D, D Turbo	ABO 02.94-12.94	63/76					JBH,L03,LL	F 026 003 318	22,2						
							L03,RLE	0 204 123 319	22,2						

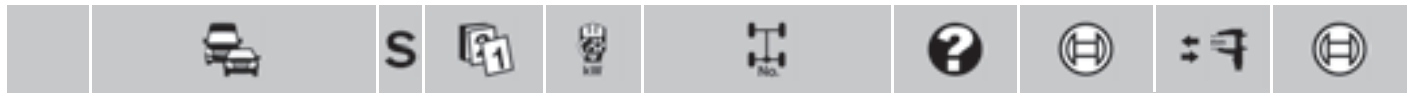

	◀ CITROEN Jumper [23]							
2.5 D, D Turbo	ABO	02.94-02.02	63/76		JBH,L02,LLE	F 026 003 313	25,4	
					L02,RLE	0 204 123 314	25,4	
					L03,RLE	0 204 123 325	23,8	
	ABS	02.94-12.94	63/76			L03	0 204 123 320	22,2
							F 026 003 315	25,4
2.5 TDi	ABO	10.96-02.02	79		JBH,L02,LLE	F 026 003 313	25,4	
					L02,RLE	0 204 123 314	25,4	
					L03,RLE	0 204 123 325	23,8	
	ABS	10.96-02.02	79			F 026 003 315	25,4	
2.8 D	ABO	01.99-02.02	64/90/94		JBH,L02,LLE	F 026 003 313	25,4	
					L02,RLE	0 204 123 314	25,4	
					L03,RLE	0 204 123 325	23,8	
2.8 D Turbo								
2.8 HDi	ABS	01.99-02.02	64/90/94			F 026 003 315	25,4	

	1.9 D	02.94-02.02	51	Fg.-Nr. →15064995	L03	0 204 125 445					
					Fg.-Nr. →15984271	L02,LLE	0 204 125 746				
					Fg.-Nr. 15064996→	L03,LLE	0 204 125 746				
					15984271						
					Fg.-Nr. 15687087→	RLE	0 204 125 746				
					15984271						
					Fg.-Nr. 15984272→	LLE	0 204 125 772				
						L02,RLE	0 204 125 772				
						L03,RLE	0 204 125 773				
						01.99-02.02	51	Fg.-Nr. →15984271	LLE	0 204 125 746	
					1.9 D Turbo	02.94-02.02	66-68	Fg.-Nr. →15064995	L03	0 204 125 445	
Fg.-Nr. →15984271	L02,LLE	0 204 125 746									
Fg.-Nr. 15064996→	L03,LLE	0 204 125 746									
15984271											
Fg.-Nr. 15687087→	RLE	0 204 125 746									
15984271											
Fg.-Nr. 15984272→	LLE	0 204 125 772									
	L02,RLE	0 204 125 772									
	L03,RLE	0 204 125 773									
	01.99-02.02	51	Fg.-Nr. →15984271	LLE					0 204 125 746		



	1.9 D	ABO	02.94-02.02	51/66-68		0 204 131 232^A	
	1.9 D Turbo	ABS	12.94-06.97	51/66-68	Fg.-Nr. →15445357	0 204 131 217^A	
	2.0	ABO	02.94-02.02	79/80		0 204 131 232^A	
	2.0 i	ABS	12.94-06.97	79/80	Fg.-Nr. →15445357	0 204 131 217^A	
	2.5 D, D Turbo, TDi	ABO	02.94-02.02	63/76/79		0 204 131 232^A	
		ABS	12.94-06.97	63/76/79	Fg.-Nr. →15445357	0 204 131 217^A	
	2.8 D, D Turbo	ABO	01.99-02.02	64/90		0 204 131 232^A	

	1.9 D		02.94-02.02	51/66-68	Fg.-Nr. 15445358→	L02	0 265 216 530^B
	1.9 D Turbo					L03	0 265 216 436^B
	2.0, HDi, i		02.94-02.02	62/79/80	Fg.-Nr. 15445358→	L02	0 265 216 530^B
						L03	0 265 216 436^B

		S							
2.5 D, D Turbo, TDi		02.94-02.02	63/76/79	Fg.-Nr. 15445358→	L02		0 265 216 530 ^B		
					L03		0 265 216 436 ^B		
2.8 D, D Turbo, HDi		01.99-02.02	64/90/94	Fg.-Nr. 15445358→	L02		0 265 216 530 ^B		
					L03		0 265 216 436 ^B		
1.9 D, D Turbo		02.94-02.02	51/66-68	Fg.-Nr. 15445358→	L03		1 273 004 168 ^H		
2.0, HDi, i		02.94-02.02	62/79/80	Fg.-Nr. 15445358→	L03		1 273 004 168 ^H		
2.5 D, D Turbo, TDi		02.94-02.02	63/76/79	Fg.-Nr. 15445358→	L03		1 273 004 168 ^H		
2.8 D, D Turbo, HDi		01.99-02.02	64/90/94	Fg.-Nr. 15445358→	L03		1 273 004 168 ^H		
Jumpy [G9]									
1.6 HDi		02.07-07.08	66	Org.-Nr. →11556			0 265 234 213 ^T		
		08.08-06.10	66	Org.-Nr. 11557→12256			0 265 251 176 ^T		
2.0 HDi		04.10-06.10	120	Org.-Nr. →12256			0 265 251 176 ^T		
2.0 HDi		02.07-07.08	88/100/103	Org.-Nr. →11556			0 265 234 213 ^T		
2.0 16V		08.08-06.10	88/100/103	Org.-Nr. 11557→12256			0 265 251 176 ^T		
1.6 HDi		02.07-11.07	66	Org.-Nr. →11318			0 265 005 606		
		12.07-07.08	66	Org.-Nr. 11319→11556			0 265 005 724		
		08.08→	66	Org.-Nr. 11557→			0 265 005 765		
		12.10→	66				0 265 005 765		
2.0 HDi		02.07-11.07	88	Org.-Nr. →11318			0 265 005 606		
		12.07-07.08	88	Org.-Nr. 11319→11556			0 265 005 724		
		08.08→	88	Org.-Nr. 11557→			0 265 005 765		
		04.10→	120				0 265 005 765		
		07.11→	72				0 265 005 765		
			94				0 265 005 765		
2.0 HDi		02.07-11.07	100/103	Org.-Nr. →11318			0 265 005 606		
2.0 16V		12.07-07.08	100/103	Org.-Nr. 11319→11556			0 265 005 724		
		08.08→	100/103	Org.-Nr. 11557→			0 265 005 765		
Jumpy [U64]									
1.6 i	ABO	10.95-05.99	58	Org.-Nr. →8206					0 204 124 059 ⁶
									0 204 124 073 ⁶
					JBH	F 026 003 166	23,8		
						F 026 003 188	22,2		
		06.99-01.07	58	Org.-Nr. 8207→	JBH	F 026 003 188	22,2		
						F 026 003 517	23,81		
	ABS	10.95-05.99	58	Org.-Nr. →8206		0 204 123 182	23,8		
									0 204 124 136 ⁶
					JBH	F 026 003 518	22,2		
		06.99-01.07	58	Org.-Nr. 8207→	JBH	F 026 003 516	23,81		
						F 026 003 518	22,2		
1.9 D	ABO	10.95-05.99	50-52	Org.-Nr. →8206					0 204 124 059 ⁶
									0 204 124 073 ⁶
					JBH	F 026 003 166	23,8		
						F 026 003 188	22,2		
		10.98-05.99	51	Org.-Nr. →8206					0 204 124 073 ⁶
					JBH	F 026 003 166	23,8		
		10.98-08.01	51						0 204 124 059 ⁶
					JBH	F 026 003 188	22,2		
		06.99-08.01	51	Org.-Nr. 8207→	JBH	F 026 003 517	23,81		
		06.99-01.07	50-52	Org.-Nr. 8207→	JBH	F 026 003 188	22,2		
						F 026 003 517	23,81		
		09.01-01.07	52		JBH	F 026 003 188	22,2		
						F 026 003 517	23,81		



















		S									
CITROEN Jumpy [U64]											
	1.9 D	ABS	10.95-05.99	50-52	Org.-Nr. →8206		0 204 123 182	23,8			
									0 204 124 136 ⁶		
								JBH	F 026 003 518	22,2	
				10.98-05.99	51	Org.-Nr. →8206			0 204 123 182	23,8	
				10.98-08.01	51						0 204 124 136 ⁶
								JBH	F 026 003 518	22,2	
				06.99-08.01	51	Org.-Nr. 8207→		JBH	F 026 003 516	23,81	
				06.99-01.07	50-52	Org.-Nr. 8207→		JBH	F 026 003 516	23,81	
									F 026 003 518	22,2	
				09.01-01.07	52			JBH	F 026 003 516	23,81	
						F 026 003 518	22,2				
	1.9 D Turbo	ABO	10.95-05.99	66/67-68	Org.-Nr. →8206				0 204 124 059 ⁶		
									0 204 124 073 ⁶		
								JBH	F 026 003 166	23,8	
									F 026 003 188	22,2	
				06.99-01.07	66/67-68	Org.-Nr. 8207→		JBH	F 026 003 188	22,2	
									F 026 003 517	23,81	
				ABS	10.95-05.99	66/67-68	Org.-Nr. →8206		0 204 123 182	23,8	
											0 204 124 136 ⁶
								JBH	F 026 003 518	22,2	
				06.99-01.07	66/67-68	Org.-Nr. 8207→		JBH	F 026 003 516	23,81	
						F 026 003 518	22,2				
	2.0 HDi, i	ABO	10.99-01.07	70/80/81/100		JBH	F 026 003 517	23,81			
		ABS	10.99-01.07	70/80/81/100		JBH	F 026 003 516	23,81			
	1.6 i		10.95-01.07	58		FCC, LLE	0 204 125 714				
						FCC, LLE	0 204 125 716				
						RLE	0 204 125 109				
	1.9 D		10.95-01.07	50-52/66/		FCC, LLE	0 204 125 714				
		1.9 D Turbo			67-68	FCC, LLE	0 204 125 716				
						RLE	0 204 125 109				
	2.0 HDi		10.99-01.07	70/80/81/		FCC, LLE	0 204 125 714				
	2.0 i			100		FCC, LLE	0 204 125 715				
						RLE	0 204 125 109				
		1.6 i		10.95-01.07	58			0 204 131 085 ^A			
1.9 D, D Turbo			10.95-01.07	50-52/66/67-68			0 204 131 085 ^A				
2.0 HDi, i			10.99-01.07	70/80/81/100			0 204 131 085 ^A				
	1.6 i		06.97-05.99	58	Org.-Nr. 7481→8420		0 265 216 496 ^B				
			06.99-01.07	58	Org.-Nr. 8421→		0 265 216 725 ^B				
		1.9 D		06.97-05.99	50-52	Org.-Nr. 7481→8420		0 265 216 496 ^B			
			06.99-01.07	50-52	Org.-Nr. 8421→		0 265 216 725 ^B				
			09.01-01.07	52			0 265 216 725 ^B				
	1.9 D Turbo		06.97-05.99	66/67-68	Org.-Nr. 7481→8420		0 265 216 496 ^B				
			06.99-01.07	66/67-68	Org.-Nr. 8421→		0 265 216 725 ^B				
	2.0 HDi, i		10.99-01.07	70/80/81/100			0 265 216 725 ^B				
	Picasso										
		1.6 i		06.02-02.07	78			F 026 003 536	23,81		
	1.6 i		06.02-02.07	78			0 204 125 734				
	1.6 i		06.02-02.07	78			0 265 216 643 ^B				

















Saxo [S8]

Icon	Model	Year Range	Power	Options	Part Code	Power	Notes
	Electrique	01.97-09.03	11-20		JBH	F 026 003 342	20,6
	1.0i	ABO 02.96-09.03	33/37		3LO,JBH ATE	F 026 003 342	20,6
					BSY	F 026 003 342	20,6
				4LO	BRB, BSY		0 204 124 143 ⁶
				4LO,JBH	BRB, BSY	F 026 003 207	19
	1.1i	ABO 02.96-09.03	40-44		JBH	ATE F 026 003 342	20,6
					BSY	F 026 003 342	20,6
				4LO,VTS	BRB, BSY		0 204 124 143 ⁶
				4LO,JBH, VTS	BRB, BSY	F 026 003 207	19
		03.00-09.03	44		BSY		0 204 124 143 ⁶
		ABS 02.96-09.03	40-44		JBH	BSY F 026 003 207	19
					BSY		0 204 124 144 ⁶
	1.4i	ABO 02.96-09.03	55		JBH	BSY F 026 003 208	20,6
				VTS	BSY		0 204 124 143 ⁶
				JBH,VTS	BSY	F 026 003 207	19
				JBH,VTS	ATE	F 026 003 342	20,6
					BSY	F 026 003 342	20,6
		ABS 02.96-09.03	55		BSY		0 204 124 144 ⁶
				JBH	BSY	F 026 003 208	20,6
	1.5 D	ABO 07.96-09.03	40/42			BSY	0 204 124 143 ⁶
				JBH	BSY	F 026 003 207	19
		ABS 07.96-09.03	40/42			BSY	0 204 124 144 ⁶
				JBH	BSY	F 026 003 208	20,6
	1.6i	ABO 02.96-09.03	65-66		JBH	BSY F 026 003 342	20,6
				3LO,JBH	ATE	F 026 003 342	20,6
		06.00-09.03	74		JBH	ATE F 026 003 342	20,6
					BSY	F 026 003 342	20,6
		ABS 02.96-09.03	65-66/74		VTS	BSY	0 204 124 144 ⁶
				JBH,VTS	BSY	F 026 003 208	20,6
	1.6i 16V	ABO 07.96-09.03	87-88		JBH	F 026 003 342	20,6
	Electrique	01.97-09.03	11-20			BSY	0 204 125 484
	1.0i	02.96-09.03	33/37		BD7, LLE		0 204 125 485
					BD7, RLE		0 204 125 094
					BD8, LLE		0 204 125 484
					BD8, RLE		0 204 125 216
	1.1i	02.96-09.03	40-44		BD7, LLE		0 204 125 485
					BD7, RLE		0 204 125 094
					BD8, LLE		0 204 125 484
					BD8, RLE		0 204 125 216
	1.4i	02.96-09.03	55		BD7, LLE		0 204 125 485
					BD7, RLE		0 204 125 094
					BD8, LLE		0 204 125 484
					BD8, RLE		0 204 125 216
	1.5 D	07.96-09.03	40/42		BD7, LLE		0 204 125 485
					BD7, RLE		0 204 125 094
					BD8, LLE		0 204 125 484
					BD8, RLE		0 204 125 216
	1.6i	02.96-09.03	65-66/74/		BD8, LLE		0 204 125 484
	1.6i 16V		87-88		BD8, RLE		0 204 125 216
	1.1i	ABS 02.96-09.03	40-44				0 204 131 093 ^A
	1.4i	ABS 02.96-09.03	55				0 204 131 093 ^A
	1.5 D	ABS 07.96-09.03	40/42				0 204 131 093 ^A

		S								
CITROEN Saxo [S8]										
1.6 i		02.96-09.03	65-66/74		4SB		0 204 131 092 ^A			
	ABS	02.96-09.03	65-66/74		STB		0 204 131 093 ^A			
1.6 i 16V		07.96-09.03	87-88				0 204 131 092 ^A			
Xsara Break [N6]										
1.4 i	ABO	04.98-08.00	55		JBH		F 026 003 502	22,2		
	ABS	04.98-08.00	55				F 026 003 350	23,81		
1.5 D	ABO	10.97-08.00	42		JBH		F 026 003 502	22,2		
	ABS	10.97-08.00	42				F 026 003 350	23,81		
1.6 i	ABO	10.97-08.00	65-66		JBH		F 026 003 502	22,2		
	ABS	10.97-08.00	65-66				F 026 003 350	23,81		
1.8 D	ABO	04.98-08.00	44		JBH		F 026 003 502	22,2		
1.8 D, i, i 16V	ABS	04.98-08.00	44/66/74-75/81-82				F 026 003 350	23,81		
1.8 i, i 16V	ABO	04.98-08.00	66/74-75/81-82				0 204 123 373	23,81		
1.9 D	ABO	04.98-08.00	50/51		JBH		F 026 003 502	22,2		
1.9 D Turbo	ABO	04.98-08.00	66				0 204 123 373	23,81		
1.9 D, D Turbo	ABS	04.98-08.00	50/51/55/66				F 026 003 350	23,81		
2.0 HDi	ABO	07.98-08.00	66/97				0 204 123 373	23,81		
2.0 i 16V	ABS	07.98-08.00	66/97				F 026 003 350	23,81		
1.4 i	ABS	04.98-08.00	55			BO	0 204 125 514			
	ABS	10.97-08.00	42			BO	0 204 125 514			
	ABS	10.97-08.00	65-66			BO	0 204 125 514			
	ABS	04.98-08.00	44			BO	0 204 125 514			
			04.98-08.00	66/74-75/81-82				0 204 125 514		
	ABS	04.98-08.00	50/51/55/66			BO	0 204 125 514			
			07.98-08.00	97				0 204 125 514		
1.4 i	ABO	04.98-08.00	55				0 204 131 269 ^A			
	ABS	04.98-08.00	55				0 204 131 268 ^A			
	ABO	10.97-08.00	42				0 204 131 269 ^A			
	ABS	10.97-08.00	42				0 204 131 268 ^A			
	ABO	04.98-08.00	44				0 204 131 269 ^A			
	ABS	04.98-08.00	44				0 204 131 268 ^A			
			04.98-08.00	66/74-75				0 204 131 268 ^A		
			04.98-08.00	81-82				0 204 131 272 ^A		
	ABO	04.98-08.00	50				0 204 131 269 ^A			
			51					0 204 131 269 ^A		
	ABS	04.98-08.00	50		FEN		0 204 131 268 ^A			
					FEV		0 204 131 269 ^A			
			51		FEN		0 204 131 268 ^A			
					FEV		0 204 131 269 ^A			
1.9 D Turbo		04.98-08.00	55/66				0 204 131 268 ^A			
2.0 HDi		02.99-08.00	66				0 204 131 270			
2.0 i 16V		07.98-08.00	97				0 204 131 272 ^A			
1.4 i		04.98-08.00	55		STB		0 265 216 554 ^B			
		10.97-08.00	42		STB		0 265 216 554 ^B			
		10.97-08.00	65-66		STB		0 265 216 554 ^B			
	1.8 D, i		04.98-08.00	44/66	STB		0 265 216 554 ^B			
	1.8 i		04.98-08.00	74-75	SBR		0 265 216 484 ^B			
					STB		0 265 216 554 ^B			
	1.8 i 16V		04.98-08.00	81-82	SBR		0 265 216 484 ^B			
	1.9 D, D Turbo		04.98-08.00	50/51/55/66	STB		0 265 216 554 ^B			
	2.0 HDi		02.99-08.00	66			0 265 216 554 ^B			
	2.0 i 16V		07.98-08.00	97	SBR		0 265 216 484 ^B			
1.4 i		04.98-08.00	55		STB		1 273 004 278 ^H			
		10.97-08.00	42		STB		1 273 004 278 ^H			
		10.97-08.00	65-66		STB		1 273 004 278 ^H			



















		S							
1.8 D, i		04.98-08.00	44/66/74-75			STB	1 273 004 278 ^H		
1.9 D, D Turbo		04.98-08.00	50/51/55/66			STB	1 273 004 278 ^H		
2.0 HDi		02.99-08.00	66				1 273 004 278 ^H		
Xsara Break [N7]									
									
	1.4 HDi	ABS 01.03-12.05	50			JBH	0 986 480 876	23,8	
	1.4 i	ABO 09.00-07.01	55	Org.-Nr. →9001			0 204 123 373	23,81	0 204 124 073 ^B
		ABS 09.00-07.01	55	Org.-Nr. →9001			F 026 003 350	23,81	
		08.01-12.05	55	Org.-Nr. 9002→		JBH	0 986 480 876	23,8	
	1.6 i 16V	ABO 09.00-07.01	80	Org.-Nr. →9001			0 204 123 373	23,81	0 204 124 073 ^B
		ABS 09.00-07.01	80	Org.-Nr. →9001			F 026 003 350	23,81	
		08.01-03.10	80	Org.-Nr. 9002→		JBH	0 986 480 876	23,8	
	1.9 D	ABO 09.00-07.01	52	Org.-Nr. →9001			0 204 123 373	23,81	0 204 124 073 ^B
		ABS 09.00-07.01	52	Org.-Nr. →9001			F 026 003 350	23,81	
		08.01-12.05	52	Org.-Nr. 9002→		JBH	0 986 480 876	23,8	
	2.0 HDi	ABO 09.00-07.01	66/80/100	Org.-Nr. →9001			0 204 123 373	23,81	0 204 124 073 ^B
	2.0 i 16V	ABS 09.00-07.01	66/80/100	Org.-Nr. →9001			F 026 003 350	23,81	
		08.01-03.10	66/80/100	Org.-Nr. 9002→		JBH	0 986 480 876	23,8	
	1.4 i	09.00-07.01	55	Org.-Nr. →9001		RLE	0 204 125 514		
		ABO 09.00-07.01	55	Org.-Nr. →9001		LLE	0 204 125 751		
		ABS 09.00-07.01	55	Org.-Nr. →9001		LLE	0 204 125 750		
	1.6 i 16V	09.00-07.01	80	Org.-Nr. →9001		RLE	0 204 125 514		
		ABO 09.00-07.01	80	Org.-Nr. →9001		LLE	0 204 125 751		
		ABS 09.00-07.01	80	Org.-Nr. →9001		LLE	0 204 125 750		
	1.9 D	09.00-07.01	52	Org.-Nr. →9001		RLE	0 204 125 514		
		ABO 09.00-07.01	52	Org.-Nr. →9001		LLE	0 204 125 751		
		ABS 09.00-07.01	52	Org.-Nr. →9001		LLE	0 204 125 750		
	2.0 HDi	09.00-07.01	66/80	Org.-Nr. →9001		RLE	0 204 125 514		
		ABO 09.00-07.01	66/80	Org.-Nr. →9001		LLE	0 204 125 751		
		ABS 09.00-07.01	66/80	Org.-Nr. →9001		LLE	0 204 125 750		
	2.0 i 16V	09.00-07.01	100	Org.-Nr. →9001		LLE	0 204 125 750		
						RLE	0 204 125 514		
	1.4 HDi, i	09.00-12.05	50/55				0 204 131 270		
	1.6 i 16V	09.00-03.10	80				0 204 131 270		
	1.9 D	09.00-12.05	52				0 204 131 270		
	2.0 HDi, i 16V	09.00-03.10	66/80/100				0 204 131 270		
	1.4 HDi	09.00-12.05	50/55				0 265 216 723 ^B		
	1.4 i						0 265 225 128 ^T		
	1.6 i 16V	09.00-03.10	80				0 265 216 723 ^B		
							0 265 225 128 ^T		
	1.9 D	09.00-12.05	52				0 265 216 723 ^B		
							0 265 225 128 ^T		
	2.0 HDi	09.00-03.10	66/80/100				0 265 216 723 ^B		
	2.0 i 16V						0 265 225 128 ^T		
	1.4 HDi, i	09.00-12.05	50/55				0 265 005 290		
	1.6 i 16V	09.00-03.10	80				0 265 005 290		
	1.9 D	09.00-12.05	52				0 265 005 290		
	2.0 HDi, i 16V	09.00-03.10	66/80/100				0 265 005 290		
Xsara Coupé [N6]									
									
	1.4 i	ABO 07.97-08.00	55			JBH	F 026 003 502	22,2	
		ABS 07.97-08.00	55			JBH, LLE ATE	0 986 480 854	22,2	
						JBH	F 026 003 501		
						JBH, RLE ATE	0 986 480 854	22,2	

		S							
◀ CITROEN Xsara Coupé [N6]									
1.6	ABO	07.97-08.00	65			JBH	F 026	003 502	22,2
	ABS	07.97-08.00	65			JBH	ATE	0 986 480 854	22,2
							BO	F 026 003 501	
1.8 D	ABO	07.97-08.00	44/66/74			JBH	F 026	003 502	22,2
1.8 i	ABS	07.97-08.00	44/66/74			JBH,LLE	ATE	0 986 480 854	22,2
						JBH		F 026 003 501	
						JBH,RLE	ATE	0 986 480 854	22,2
1.8 i 16V	ABO	07.97-08.00	81-82				0 204	123 373	23,81
	ABS	07.97-08.00	81-82				F 026	003 350	23,81
1.9 D	ABO	07.97-08.00	50/51			JBH	F 026	003 502	22,2
1.9 D Turbo	ABO	07.97-08.00	66			JBH	F 026	003 502	22,2
		01.98-08.00	55				0 204	123 373	23,81
						JBH	F 026	003 502	22,2
1.9 D	ABS	07.97-08.00	50/51/55/			JBH,LLE	ATE	0 986 480 854	22,2
1.9 D Turbo			66			JBH		F 026 003 501	
						JBH,RLE	ATE	0 986 480 854	22,2
2.0 HDi	ABO	02.99-08.00	66			JBH	F 026	003 502	22,2
	ABS	02.99-08.00	66			JBH,LLE	ATE	0 986 480 854	22,2
						JBH		F 026 003 501	
						JBH,RLE	ATE	0 986 480 854	22,2
2.0 i 16V	ABO	07.97-08.00	97				0 204	123 373	23,81
	ABS	07.97-08.00	97/120-123				F 026	003 350	23,81
	1.8 i 16V		07.97-08.00	81-82			0 204	125 514	
	2.0 i 16V		07.97-08.00	97/120-123			0 204	125 514	
	1.4 i	ABS	07.97-08.00	55			0 204	131 268^A	
							0 204	131 269^A	
1.6			07.97-02.99	65	Org.-Nr. →8119		0 204	131 268	
			03.99-08.00	65	Org.-Nr. 8120→		0 204	131 270	
1.8 D	ABS	07.97-08.00	44				0 204	131 268^A	
1.8 i		07.97-08.00	66/74				0 204	131 269^A	
1.8 i 16V		07.97-08.00	81-82				0 204	131 268^A	
1.9 D	ABS	07.97-08.00	50/51				0 204	131 268^A	
							0 204	131 269^A	
1.9 D Turbo		07.97-08.00	55/66				0 204	131 269^A	
2.0 HDi		02.99-08.00	66				0 204	131 270	
2.0 i 16V		07.97-08.00	97				0 204	131 268^A	
			120-123				0 204	131 272^A	
	1.4 i		07.97-08.00	55		STB	0 265	216 483^B	
	1.6		07.97-08.00	65			0 265	216 483^B	
	1.8 D, i		07.97-08.00	44/66/74		STB	0 265	216 483^B	
	1.8 i 16V		07.97-08.00	81-82		SBR	0 265	216 484^B	
	1.9 D, D Turbo		07.97-08.00	50/51/55/66		STB	0 265	216 483^B	
	2.0 HDi		02.99-08.00	66			0 265	216 484^B	
	2.0 i 16V		07.97-08.00	97/120-123		SBR	0 265	216 484^B	
Xsara Coupé [N7]									
	1.4 HDi	ABS	01.03-12.05	50		JBH	0 986	480 876	23,8
	1.4 i	ABO	09.00-07.01	55	Org.-Nr. →9001		0 204	123 373	23,81
ABS		09.00-07.01	55	Org.-Nr. →9001		F 026	003 350	23,81	
		08.01-12.05	55	Org.-Nr. 9002→		JBH	0 986	480 876	23,8
1.6 i 16V	ABO	09.00-07.01	80	Org.-Nr. →9001		0 204	123 373	23,81	
	ABS	09.00-07.01	80	Org.-Nr. →9001		F 026	003 350	23,81	
		08.01-12.05	80	Org.-Nr. 9002→		JBH	0 986	480 876	23,8
1.9 D	ABO	09.00-07.01	52	Org.-Nr. →9001		0 204	123 373	23,81	
	ABS	09.00-07.01	52	Org.-Nr. →9001		F 026	003 350	23,81	
		08.01-12.05	52	Org.-Nr. 9002→		JBH	0 986	480 876	23,8

										
2.0 HDi, i 16V	ABO	09.00-07.01	66/80/100/120	Org.-Nr. →9001			0 204 123 373	23,81	0 204 124 073 ⁶	
	ABS	09.00-07.01	66/80/100/120	Org.-Nr. →9001			F 026 003 350	23,81		
		08.01-12.05	66/80/100/120	Org.-Nr. 9002→	JBH		0 986 480 876	23,8		
 1.4 i		09.00-07.01	55	Org.-Nr. →9001	RLE		0 204 125 514			
	ABO	09.00-07.01	55	Org.-Nr. →9001	LLE		0 204 125 751			
	ABS	09.00-07.01	55	Org.-Nr. →9001	LLE		0 204 125 750			
1.6 i 16V		09.00-07.01	80	Org.-Nr. →9001	RLE		0 204 125 514			
	ABO	09.00-07.01	80	Org.-Nr. →9001	LLE		0 204 125 751			
	ABS	09.00-07.01	80	Org.-Nr. →9001	LLE		0 204 125 750			
1.9 D		09.00-07.01	52	Org.-Nr. →9001	RLE		0 204 125 514			
	ABO	09.00-07.01	52	Org.-Nr. →9001	LLE		0 204 125 751			
	ABS	09.00-07.01	52	Org.-Nr. →9001	LLE		0 204 125 750			
2.0 HDi		09.00-07.01	66/80	Org.-Nr. →9001	RLE		0 204 125 514			
	ABO	09.00-07.01	66/80	Org.-Nr. →9001	LLE		0 204 125 751			
	ABS	09.00-07.01	66/80	Org.-Nr. →9001	LLE		0 204 125 750			
2.0 i 16V		09.00-07.01	100/120	Org.-Nr. →9001	LLE		0 204 125 750			
					RLE		0 204 125 514			
 1.4 HDi, i		09.00-12.05	50/55				0 204 131 270			
	1.6 i 16V	09.00-12.05	80				0 204 131 270			
	1.9 D	09.00-12.05	52				0 204 131 270			
	2.0 HDi	09.00-12.05	66/80				0 204 131 270			
 1.4 HDi		09.00-12.05	50/55				0 265 216 723 ^B			
	1.4 i						0 265 225 128 ^T			
	1.6 i 16V		09.00-12.05	80				0 265 216 723 ^B		
								0 265 225 128 ^T		
	1.9 D		09.00-12.05	52				0 265 216 723 ^B		
								0 265 225 128 ^T		
2.0 HDi	09.00-12.05	66/80/100/120				0 265 216 723 ^B				
2.0 i 16V							0 265 225 128 ^T			
 1.4 HDi, i		09.00-12.05	50/55				0 265 005 290			
	1.6 i 16V	09.00-12.05	80				0 265 005 290			
	1.9 D	09.00-12.05	52				0 265 005 290			
	2.0 HDi, i 16V	09.00-12.05	66/80/100/120				0 265 005 290			
Xsara [N6]										
										
 1.4 i	ABO	07.97-08.00	55			JBH	F 026 003 502	22,2		
	ABS	07.97-08.00	55			JBH,LLE ATE	0 986 480 854	22,2		
1.5 D						JBH	F 026 003 501			
						JBH,RLE ATE	0 986 480 854	22,2		
	ABO	07.97-08.00	42			JBH	F 026 003 502	22,2		
	ABS	07.97-08.00	42			JBH,LLE ATE	0 986 480 854	22,2		
1.6 i						JBH	F 026 003 501			
						JBH,RLE ATE	0 986 480 854	22,2		
	ABO	07.97-08.00	65-66			JBH	F 026 003 502	22,2		
	ABS	07.97-08.00	65-66			JBH,LLE ATE	0 986 480 854	22,2		
1.8 D						JBH	F 026 003 501			
						JBH,RLE ATE	0 986 480 854	22,2		
	ABO	07.97-08.00	44/66/74-75			JBH	F 026 003 502	22,2		
	ABS	07.97-08.00	44/66/74-75			JBH,LLE ATE	0 986 480 854	22,2		
1.8 i 16V						JBH	F 026 003 501			
						JBH,RLE ATE	0 986 480 854	22,2		
	ABO	07.97-08.00	81-82				0 204 123 373	23,81		
	ABS	07.97-08.00	81-82				F 026 003 350	23,81		



		S											
◀ CITROEN Xsara [N6]													
1.9 D	ABO	07.97-08.00	50/51/55/66			JBH	F 026 003 502	22,2					
1.9 D Turbo	ABS	07.97-08.00	50/51/55/66			JBH,LLE	ATE 0 986 480 854	22,2					
						JBH	F 026 003 501						
						JBH,RLE	ATE 0 986 480 854	22,2					
2.0 HDi	ABO	02.99-08.00	66			JBH	F 026 003 502	22,2					
				ABS	02.99-08.00	66			JBH,LLE	ATE 0 986 480 854	22,2		
									JBH	F 026 003 501			
						JBH,RLE	ATE 0 986 480 854	22,2					
2.0 i 16V	ABO	07.97-08.00	97				0 204 123 373	23,81					
				ABS	07.97-08.00	97/120-123			F 026 003 350	23,81			
<hr/>													
	1.8 i 16V		07.97-08.00	81-82			0 204 125 514						
	2.0 i 16V		07.97-08.00	97/120-123			0 204 125 514						
<hr/>													
	1.4 i	ABS	07.97-08.00	55			0 204 131 268 ^A						
							0 204 131 269 ^A						
	1.5 D	ABS	07.97-08.00	42			0 204 131 269 ^A						
	1.8 D	ABS	07.97-08.00	44			0 204 131 268 ^A						
	1.8 i		07.97-08.00	66/74-75			0 204 131 269 ^A						
	1.8 i 16V		07.97-08.00	81-82			0 204 131 268 ^A						
	1.9 D	ABS	07.97-08.00	50/51			0 204 131 268 ^A						
							0 204 131 269 ^A						
	1.9 D Turbo		07.97-08.00	55/66			0 204 131 269 ^A						
	2.0 HDi		02.99-08.00	66			0 204 131 270						
	2.0 i 16V		07.97-08.00	97			0 204 131 268 ^A						
							120-123			0 204 131 272 ^A			
<hr/>													
	1.4 i		07.97-08.00	55		STB	0 265 216 483 ^B						
	1.5 D		07.97-08.00	42		STB	0 265 216 483 ^B						
	1.6 i		07.97-08.00	65-66		STB	0 265 216 483 ^B						
	1.8 D, i		07.97-08.00	44/66/74-75		STB	0 265 216 483 ^B						
	1.8 i 16V		07.97-08.00	81-82		SBR	0 265 216 484 ^B						
	1.9 D, D Turbo		07.97-08.00	50/51/55/66		STB	0 265 216 483 ^B						
	2.0 HDi		02.99-08.00	66			0 265 216 484 ^B						
	2.0 i 16V		07.97-08.00	97/120-123		SBR	0 265 216 484 ^B						
<hr/>													
Xsara [N7]													
	1.4 HDi	ABS	01.03-12.05	50		JBH	0 986 480 876	23,8					
1.4 i	ABO	09.00-07.01	55	Org.-Nr. →9001			0 204 123 373	23,81	0 204 124 073 ⁶				
					ABS	09.00-07.01	55	Org.-Nr. →9001			F 026 003 350	23,81	
													08.01-12.05
1.6 i 16V	ABO	09.00-07.01	80	Org.-Nr. →9001			0 204 123 373	23,81	0 204 124 073 ⁶				
					ABS	09.00-07.01	80	Org.-Nr. →9001			F 026 003 350	23,81	
													08.01-12.05
1.9 D	ABO	09.00-07.01	51-52	Org.-Nr. →9001			0 204 123 373	23,81	0 204 124 073 ⁶				
					ABS	09.00-07.01	51-52	Org.-Nr. →9001			F 026 003 350	23,81	
													08.01-12.05
2.0 HDi	ABO	09.00-07.01	66/80/100	Org.-Nr. →9001			0 204 123 373	23,81	0 204 124 073 ⁶				
2.0 i 16V	ABS	09.00-07.01	66/80/100	Org.-Nr. →9001			F 026 003 350	23,81					
									08.01-12.05	66/80/100	Org.-Nr. 9002→	JBH	0 986 480 876
<hr/>													
	1.4 i		09.00-07.01	55	Org.-Nr. →9001	RLE	0 204 125 514						
		ABO	09.00-07.01	55	Org.-Nr. →9001	LLE	0 204 125 751						
		ABS	09.00-07.01	55	Org.-Nr. →9001	LLE	0 204 125 750						
1.6 i 16V			09.00-07.01	80	Org.-Nr. →9001	RLE	0 204 125 514						
	ABO	09.00-07.01	80	Org.-Nr. →9001	LLE	0 204 125 751							
	ABS	09.00-07.01	80	Org.-Nr. →9001	LLE	0 204 125 750							
1.9 D			09.00-07.01	51-52	Org.-Nr. →9001	RLE	0 204 125 514						
	ABO	09.00-07.01	51-52	Org.-Nr. →9001	LLE	0 204 125 751							
	ABS	09.00-07.01	51-52	Org.-Nr. →9001	LLE	0 204 125 750							

		S							
2.0 HDi		09.00-07.01	66/80	Org.-Nr. →9001		RLE	0 204 125 514		
		ABO 09.00-07.01	66/80	Org.-Nr. →9001		LLE	0 204 125 751		
		ABS 09.00-07.01	66/80	Org.-Nr. →9001		LLE	0 204 125 750		
2.0 i 16V		09.00-07.01	100	Org.-Nr. →9001		LLE	0 204 125 750		
						RLE	0 204 125 514		
	1.4 HDi, i	09.00-12.05	50/55				0 204 131 270		
	1.6 i 16V	09.00-12.05	80				0 204 131 270		
	1.9 D	09.00-12.05	51-52				0 204 131 270		
	2.0 HDi, i 16V	09.00-12.05	66/80/100				0 204 131 270		
	1.4 HDi	09.00-12.05	50/55				0 265 216 723 ^B		
	1.4 i						0 265 225 128 ^T		
	1.6 i 16V	09.00-12.05	80				0 265 216 723 ^B		
							0 265 225 128 ^T		
	1.9 D	09.00-12.05	51-52				0 265 216 723 ^B		
							0 265 225 128 ^T		
2.0 HDi		09.00-12.05	66/80/100				0 265 216 723 ^B		
	2.0 i 16V						0 265 225 128 ^T		
	1.4 HDi, i	09.00-12.05	50/55				0 265 005 290		
	1.6 i 16V	09.00-12.05	80				0 265 005 290		
	1.9 D	09.00-12.05	51-52				0 265 005 290		
	2.0 HDi, i 16V	09.00-12.05	66/80/100				0 265 005 290		
Xsara Picasso									
									
	2.0 HDi	10.00-06.12	80				0 204 123 373	23,81	
	2.0 i 16V	ABO 10.00-06.12	100				0 204 123 373	23,81	
		ABS 10.00-06.12	100				F 026 003 536	23,81	
		MFD 10.00-06.12	100			JBH	F 026 003 633	23,81	
	2.0 i 16V	10.00-06.12	100			BO	0 204 125 734		
	2.0 i 16V	10.00-06.12	100				0 986 482 031 ^A		
	2.0 HDi	10.00-06.12	80				0 265 216 643 ^B		
	2.0 i 16V	10.00-06.12	100				0 265 216 643 ^B		
								0 265 225 159 ^T	
							Org.-Nr. 10221FV→, 10313UW→, 1031378→		
							0 265 231 523 ^B		
Xsara Picasso [N68]									
									
	1.6 HDi	05.04-04.10	80			JBH	F 026 003 633	23,81	
		09.05-04.10	66			JBH	F 026 003 633	23,81	
	1.6 i	ABO 01.00-04.10	66/74			BO	0 204 123 373	23,81	0 204 124 073 ⁶
	1.6 i, i 16V	ABS 01.00-04.10	66/74/80				F 026 003 536	23,81	
	1.6 i 16V	MFD 03.05-04.10	80			JBH	F 026 003 633	23,81	
	1.8 i	ABO 01.00-04.10	85			BO	0 204 123 373	23,81	0 204 124 073 ⁶
		ABS 01.00-04.10	85				F 026 003 536	23,81	
		MFD 01.00-04.10	85			JBH	F 026 003 633	23,81	
	2.0 HDi	ABO 01.00-04.10	66			BO	0 204 123 373	23,81	0 204 124 073 ⁶
	2.0 HDi	ABS 01.00-04.10	66/100				F 026 003 536	23,81	
2.0 i 16V	MFD 01.00-04.10	66/100			JBH	F 026 003 633	23,81		
	1.6 HDi, i, i 16V	01.00-04.10	66/74/80			LLE	BO	0 204 125 734	
						RLE		0 204 125 734	



		S												
CITROEN Xsara Picasso [N68]														
	1.8 i	01.00-04.10	85				LLE BO	0 204 125 734						
							RLE	0 204 125 734						
	2.0 HDi	01.00-04.10	66/100				LLE BO	0 204 125 734						
							RLE	0 204 125 734						
	1.6 i	01.00-04.10	66/74					0 986 482 031 ^A						
	1.8 i	01.00-04.10	85					0 986 482 031 ^A						
	2.0 HDi	01.00-04.10	66					0 986 482 031 ^A						
	1.6 HDi	05.04-11.04	80	Org.-Nr. →10220				0 265 225 159 ^T						
		12.04-12.07	80	Org.-Nr. 10221→11346				0 265 234 061 ^T						
		09.05-12.07	66	Org.-Nr. →11346				0 265 234 061 ^T						
	1.6 i	01.00-04.10	66	74	Org.-Nr. →10220FV, →10312UW, →1031278				0 265 216 643 ^B					
					Org.-Nr. 10221 FV→11346 FV, 10313 UW→10313 UW, 11249 CJ→11346 CJ, 10313 78→			0 265 231 523 ^B						
	1.6 i 16V	03.05-12.07	80		Org.-Nr. →10220FV, →10312UW, →1031278				0 265 216 643 ^B					
					Org.-Nr. 10221 FV→11346 FV, 10313 UW→10313 UW, 11249 CJ→11346 CJ, 10313 78→			0 265 231 523 ^B						
	1.8 i	01.00-11.04	85		Org.-Nr. →10220				0 265 225 159 ^T					
		01.00-04.10	85		Org.-Nr. →10220FV, →10312UW, →1031278				0 265 216 643 ^B					
	2.0 HDi	12.04-12.07	85		Org.-Nr. 10221→11346				0 265 234 061 ^T					
		01.00-11.04	66/100		Org.-Nr. →10220				0 265 225 159 ^T					
	2.0 i 16V	01.00-04.10	66/100		Org.-Nr. →10220FV, →10312UW, →1031278				0 265 216 643 ^B					
Org.-Nr. 10221 FV→11346 FV, 10313 UW→10313 UW, 11249 CJ→11346 CJ, 10313 78→							0 265 231 523 ^B							
		12.04-12.07	66/100	Org.-Nr. 10221→11346				0 265 234 061 ^T						
	1.6 HDi	05.04-12.07	66/80	Org.-Nr. →11346				0 265 005 290						
	1.6 i 16V	01.08-04.10	66/80	Org.-Nr. 11347→				0 265 005 758						
	1.8 i	01.00-12.07	85	Org.-Nr. →11346					0 265 005 290					
		01.08-04.10	85	Org.-Nr. 11347→					0 265 005 758					
	2.0 HDi	01.00-12.07	66/100	Org.-Nr. →11346				0 265 005 290						
2.0 i 16V	01.08-04.10	66/100	Org.-Nr. 11347→				0 265 005 758							
ZX														
	1.6 i 8V	ABO	10.96→	65										
								JBH	F 026 003 180	20,6	0 204 124 069 ⁶			
									0 204 124 069 ⁶					
	1.6 i 8V	ABO	10.96→	65			4LO	BRB, BSY	0 204 125 079					
ZX [N20/N21]														
	1.1	ABO	03.91-03.96	40-44	Org.-Nr. →7069				KOB	BSY	0 204 123 186	20,6		
														1.1 i
									JBH,LIM	BSY	F 026 003 180	20,6		
									JBH,LIM	BSY	F 026 003 342	20,6		
						Org.-Nr. 7126→			JBH,LIM	BSY	F 026 003 342	20,6		
						ABS	03.91-03.96	40-44	Org.-Nr. →7069		BSY			0 204 124 063 ⁶
									JBH	BSY	F 026 003 142	22,2		
	1.4	ABO	08.92-03.96	37-39/55	Org.-Nr. →7069			KOB	BSY	0 204 123 186	20,6			
	1.4 D		08.92-06.96	37-39/55	Org.-Nr. →7125			LIM	BSY			0 204 124 069 ⁶		
	1.4 i				Org.-Nr. →7069			JBH,LIM	BSY	F 026 003 180	20,6			
													ABS	08.92-03.96
								JBH	BSY	F 026 003 142	22,2			

		S							
1.4 D, i	ABO	07.96-10.97	37-39/55	Org.-Nr. 7126→	JBH,LIM	BSY	F 026 003 342	20,6	
1.5 D	ABO	09.96-10.97	42	Org.-Nr. 7126→	JBH,LIM	BSY	F 026 003 342	20,6	
1.6 i	ABO	03.91-03.96	65-66	Org.-Nr. →7069	KOB	BSY	0 204 123 186	20,6	
		03.91-06.96	65-66	Org.-Nr. →7125	LIM	BSY			0 204 124 069 ⁶
		07.96-10.97	65-66	Org.-Nr. 7126→	JBH,LIM	BSY	F 026 003 180	20,6	
	ABS	03.91-03.96	65-66	Org.-Nr. →7069		BSY			0 204 124 063 ⁶
					JBH	BSY	F 026 003 142	22,2	
1.8 D	ABO	03.91-03.96	44/74-76	Org.-Nr. →7069	KOB	BSY	0 204 123 186	20,6	
1.8 i		03.91-06.96	44/74-76	Org.-Nr. →7125	LIM	BSY			0 204 124 069 ⁶
		07.96-10.97	44/74-76	Org.-Nr. 7126→	JBH,LIM	BSY	F 026 003 180	20,6	
		07.96-10.97	44/74-76	Org.-Nr. 7126→	JBH,LIM	BSY	F 026 003 342	20,6	
	ABS	03.91-03.96	44/74-76	Org.-Nr. →7069		BSY			0 204 124 063 ⁶
					JBH	BSY	F 026 003 142	22,2	
1.8 i 16V	ABO	07.96-02.98	81	Org.-Nr. 7126→	JBH,LIM	BSY	F 026 003 342	20,6	
1.9 D	ABO	03.91-04.94	47-48	Org.-Nr. →7069	KOB	BSY	0 204 123 186	20,6	
				Org.-Nr. →7125	LIM	BSY			0 204 124 069 ⁶
					JBH,LIM	BSY	F 026 003 180	20,6	
1.9 D	ABO	03.91-03.96	50/51-52/	Org.-Nr. →7069	KOB	BSY	0 204 123 186	20,6	
1.9 D Turbo			66/68/						
			88-90/						
			93-96						
		03.91-06.96	50/51-52/	Org.-Nr. →7125	LIM	BSY			0 204 124 069 ⁶
		66/68/			JBH,LIM	BSY	F 026 003 180	20,6	
		88-90/							
		93-96							
		07.96-10.97	50/51-52/	Org.-Nr. 7126→	JBH,LIM	BSY	F 026 003 342	20,6	
			66/68/						
			88-90/						
			93-96						
	ABS	03.91-03.96	47-48/50/	Org.-Nr. →7069		BSY			0 204 124 063 ⁶
			51-52/66/						
			68/88-90/						
			93-96						
					JBH	BSY	F 026 003 142	22,2	
2.0 i	ABO	07.92-03.96	89-90	Org.-Nr. →7069	KOB	BSY	0 204 123 186	20,6	
		07.92-06.96	89-90	Org.-Nr. →7125	LIM	BSY			0 204 124 069 ⁶
					JBH,LIM	BSY	F 026 003 180	20,6	
		07.96-10.97	89-90	Org.-Nr. 7126→	JBH,LIM	BSY	F 026 003 342	20,6	
	ABS	07.92-03.96	89-90	Org.-Nr. →7069		BSY			0 204 124 063 ⁶
					JBH	BSY	F 026 003 142	22,2	
2.0 i 16V		07.92-10.97	110-114				0 204 123 162	23,8	
		09.96-10.97	120-122				0 204 123 343	23,8	



1.1		03.91-03.96	40-44	Org.-Nr. →7069	BD9		0 204 125 508		
1.1 i		03.91-06.97	40-44		BD8		0 204 125 079		
1.4, D, i		08.92-03.96	37-39/55	Org.-Nr. →7069	BD9		0 204 125 508		
		08.92-10.97	37-39/55		BD8		0 204 125 079		
1.5 D		09.96-10.97	42		BD8		0 204 125 079		
1.6 i		03.91-03.96	65-66	Org.-Nr. →7069	BD9		0 204 125 508		
		03.91-10.97	65-66		BD8		0 204 125 079		
1.8 D		03.91-03.96	44/74-76	Org.-Nr. →7069	BD9		0 204 125 508		
1.8 i		03.91-10.97	44/74-76		BD8		0 204 125 079		
1.9 D		03.91-03.96	47-48/50/	Org.-Nr. →7069	BD9		0 204 125 508		
1.9 D Turbo			51-52/66/						
			68/88-90/						
1.9 i			93-96						
		03.91-10.97	47-48/50/		BD8		0 204 125 079		
			51-52/66/68/						
			88-90/93-96						
2.0 i		07.92-03.96	89-90	Org.-Nr. →7069	BD9		0 204 125 508		
		07.92-10.97	89-90		BD8		0 204 125 079		
2.0 i 16V		07.92-10.97	110-114/120-122				0 204 125 134		













◀ CITROEN ZX [N20/N21]

	1.1, i	ABS	03.91-06.97	40-44	LIM	0 204 131 257 ^A
	1.4, D, i	ABS	08.92-10.97	37-39/55	LIM	0 204 131 257 ^A
	1.4 i		08.92-10.97	55	KOB	0 204 131 258 ^A
	1.5 D		09.96-10.97	42	KOB	0 204 131 258 ^A
		ABS	09.96-10.97	42	LIM	0 204 131 257 ^A
	1.6 i		03.91-10.97	65-66	KOB	0 204 131 258 ^A
		ABS	03.91-10.97	65-66	LIM	0 204 131 257 ^A
	1.8 D, i		03.91-10.97	44/74-76	KOB	0 204 131 258 ^A
	1.8 D, i, i 16V	ABS	03.91-02.98	44/74-76/81	LIM	0 204 131 257 ^A
	1.8 i 16V		01.96-02.98	81	KOB	0 204 131 258 ^A
					4SB,LIM	0 204 131 046
	1.9 D		03.91-10.97	47-48/50/51-52	KOB	0 204 131 258 ^A
	1.9 D Turbo		03.91-10.97	66/68/88-90/	KOB	0 204 131 258 ^A
	1.9 i			93-96	4SB,LIM	0 204 131 046
	1.9 D, D Turbo, i	ABS	03.91-10.97	47-48/50/51-52/66/68/88-90/93-96	LIM	0 204 131 257 ^A
	2.0 i		07.92-10.97	89-90	KOB	0 204 131 258 ^A
					4SB,LIM	0 204 131 046
	2.0 i, i 16V	ABS	07.92-10.97	89-90/110-114	LIM	0 204 131 257 ^A
	2.0 i 16V		07.92-10.97	110-114		0 204 131 068
			09.96-10.97	120-122		0 204 131 256 ^A

	1.1		03.91-04.95	40-44	Org.-Nr. →6748	LIM	0 265 208 321 ^B
			03.91-08.96	40-44		KOB	0 265 208 321 ^B
			05.95-08.96	40-44	Org.-Nr. 6749→	LIM	0 265 216 340 ^H
	1.1 i		10.91-03.94	44			0 265 208 321 ^B
			04.94-04.95	44	Org.-Nr. →6748	LIM	0 265 208 321 ^B
			04.94-06.97	44		KOB	0 265 208 321 ^B
			05.95-08.96	44	Org.-Nr. 6749→	LIM	0 265 216 340 ^H
			09.96-06.97	44		LIM	0 265 216 340 ^B
	1.4		09.93-04.95	55	Org.-Nr. →6748	LIM	0 265 208 321 ^B
			09.93-12.95	55		KOB	0 265 208 321 ^B
			05.95-12.95	55	Org.-Nr. 6749→	LIM	0 265 216 340 ^H
	1.4 D		06.94-04.95	37-39	Org.-Nr. →6748	LIM	0 265 208 321 ^B
			06.94-06.97	37-39		KOB	0 265 208 321 ^B
			05.95-06.97	37-39	Org.-Nr. 6749→	LIM	0 265 216 340 ^H
	1.4 i		08.92-04.95	55	Org.-Nr. →6748	LIM	0 265 208 321 ^B
			08.92-10.97	55		KOB	0 265 208 321 ^B
			05.95-08.96	55	Org.-Nr. 6749→	LIM	0 265 216 340 ^H
			05.96-10.97	55		LIM	0 265 216 340 ^B
	1.5 D		09.96-10.97	42		KOB	0 265 208 321 ^B
						LIM	0 265 216 340 ^B
	1.6 i		03.91-12.94	65-66			0 265 208 321 ^B
			07.92-04.95	65	Org.-Nr. →6748	LIM	0 265 208 321 ^B
			07.92-10.97	65		KOB	0 265 208 321 ^B
			05.95-10.97	65	Org.-Nr. 6749→	LIM	0 265 216 340 ^H
			02.96-10.97	65-66		KOB	0 265 208 321 ^B
					LIM	0 265 216 340 ^B	
	1.8 D		03.91-04.95	44/74-76	Org.-Nr. →6748	LIM	0 265 208 321 ^B
	1.8 i		03.91-10.97	44/74-76		KOB	0 265 208 321 ^B
			05.95-10.97	44/74-76	Org.-Nr. 6749→	LIM	0 265 216 340 ^H
	1.8 i 16V		01.96-02.98	81		KOB	0 265 208 321 ^B
					LIM	0 265 216 340 ^B	
1.9 D		03.91-04.94	47-48			0 265 208 321 ^B	
1.9 D, D Turbo, i		03.91-04.95	50/51-52/	Org.-Nr. →6748	LIM	0 265 208 321 ^B	
			66/68/				
			88-90/				
		03.91-10.97	50/51-52/66/		KOB	0 265 208 321 ^B	
			68/88-90/				
			93-96				

									
1.9D , D Turbo, i	05.95-10.97	50/51-52/ 66/68/ 88-90/ 93-96	Org.-Nr. 6749→	LIM	0 265 216 340 ^H				
2.0i	07.92-04.95	89-90/ 110-114	Org.-Nr. →6748	LIM	0 265 208 321 ^B				
2.0i 16V	07.92-10.97	89-90/ 110-114		KOB	0 265 208 321 ^B				
	05.95-10.97	89-90/ 110-114	Org.-Nr. 6749→	LIM	0 265 216 340 ^H				
2.0i 16V	09.96-10.97	120-122		KOB	0 265 208 321 ^B				
				LIM	0 265 216 340 ^B				
1.1	03.91-04.95	40-44	Org.-Nr. 6237→6748	LIM,TEI	2 267 000 735 ^H				
	03.91-08.96	40-44		KOB	2 267 000 740 ^H				
	05.95-08.96	40-44	Org.-Nr. 6749→	HTB,LIM	1 267 000 828 ^H				
1.1i	10.91-03.94	44		LIM,TEI	2 267 000 735 ^H				
	10.91-06.97	44		KOB	2 267 000 740 ^H				
	04.94-04.95	44	Org.-Nr. 6237→6748	LIM,TEI	2 267 000 735 ^H				
	05.95-08.96	44	Org.-Nr. 6749→	HTB,LIM	1 267 000 828 ^H				
	09.96-06.97	44		HTB,LIM	1 267 000 828 ^H				
1.4	05.95-12.95	55	Org.-Nr. 6749→	HTB,LIM	1 267 000 828 ^H				
1.4	08.92-04.95	55	Org.-Nr. 6237→6748	LIM,TEI	2 267 000 735 ^H				
1.4i	08.92-10.97	55		KOB	2 267 000 740 ^H				
1.4D	06.94-04.95	37-39	Org.-Nr. 6237→6748	LIM,TEI	2 267 000 735 ^H				
	06.94-06.97	37-39		KOB	2 267 000 740 ^H				
	05.95-06.97	37-39	Org.-Nr. 6749→	HTB,LIM	1 267 000 828 ^H				
1.4i	05.95-08.96	55	Org.-Nr. 6749→	HTB,LIM	1 267 000 828 ^H				
	05.96-10.97	55		HTB,LIM	1 267 000 828 ^H				
1.5D	09.96-10.97	42		HTB,LIM	1 267 000 828 ^H				
				KOB	2 267 000 740 ^H				
1.6i	03.91-12.94	65-66		KOB	2 267 000 740 ^H				
				LIM,TEI	2 267 000 735 ^H				
	07.92-04.95	65	Org.-Nr. 6237→6748	LIM,TEI	2 267 000 735 ^H				
	07.92-10.97	65		KOB	2 267 000 740 ^H				
	05.95-10.97	65	Org.-Nr. 6749→	HTB,LIM	1 267 000 828 ^H				
	02.96-10.97	65-66		HTB,LIM	1 267 000 828 ^H				
				KOB	2 267 000 740 ^H				
1.8D	03.91-04.95	44/74-76	Org.-Nr. 6237→6748	LIM,TEI	2 267 000 735 ^H				
1.8i	03.91-10.97	44/74-76		KOB	2 267 000 740 ^H				
	05.95-10.97	44/74-76	Org.-Nr. 6749→	HTB,LIM	1 267 000 828 ^H				
1.8i 16V	01.96-02.98	81		HTB,LIM	1 267 000 828 ^H				
				KOB	2 267 000 740 ^H				
				LIM,SBR	1 267 000 821 ^H				
1.9D	03.91-04.94	47-48		KOB	2 267 000 740 ^H				
				LIM,TEI	2 267 000 735 ^H				
	03.91-04.95	50/51-52	Org.-Nr. 6237→6748	LIM,TEI	2 267 000 735 ^H				
	03.91-10.97	50/51-52		KOB	2 267 000 740 ^H				
	05.95-10.97	50/51-52	Org.-Nr. 6749→	HTB,LIM	1 267 000 828 ^H				
1.9D Turbo	07.92-04.95	66/68	Org.-Nr. 6237→6748	LIM,TEI	2 267 000 735 ^H				
	07.92-10.97	66/68		KOB	2 267 000 740 ^H				
	05.95-10.97	66/68	Org.-Nr. 6749→	HTB,LIM	1 267 000 828 ^H				
				LIM,SBR	1 267 000 821 ^H				
1.9i	03.91-04.95	88-90/ 93-96	Org.-Nr. 6237→6748	LIM,TEI	2 267 000 735 ^H				
	03.91-10.97	88-90/ 93-96		KOB	2 267 000 740 ^H				
	05.95-10.97	88-90/ 93-96	Org.-Nr. 6749→	LIM,SBR	1 267 000 821 ^H				
2.0i , i 16V	07.92-04.95	89-90/ 110-114	Org.-Nr. 6237→6748	LIM,TEI	2 267 000 735 ^H				
	07.92-10.97	89-90/110-114		KOB	2 267 000 740 ^H				



CPU



	◀ CITROEN ZX [N20/N21]								
	2.0 i, i 16V	05.95-10.97	89-90/ 110-114	Org.-Nr. 6749→	LIM,SBR	1 267 000 821 ^H			
	2.0 i 16V	09.96-10.97	120-122		KOB LIM,SBR	2 267 000 740 ^H 1 267 000 821 ^H			

DACIA

Duster [HS]























	1.2	09.13→	92			0 265 230 752 ^T 0 265 232 385 ^B		
	1.5 dCi	10.09→	63 79			0 265 230 752 ^T 0 265 232 385 ^B 0 265 230 752 ^T 0 265 232 385 ^B		
		12.10→	66			0 265 232 385 ^B		
	1.5 dCi	10.09→	80/81			0 265 230 752 ^T		
	1.5 dCi 4x4	12.10→	66			0 265 232 387 ^B		
	1.5 dCi 4x4	12.10→	66			0 265 232 387 ^B		
	1.6	10.09→	77			0 265 232 385 ^B		
		09.13→	77			0 265 232 387 ^B		
	1.6, 4x4	10.09→	77			0 265 230 752 ^T		
	1.6 4x4	10.09→	77			0 265 232 387 ^B		
	1.2	09.13→	92			0 265 005 811		
	1.5 dCi, dCi 4x4	10.09→	63/66/79/80/81			0 265 005 811		
	1.6, 4x4	10.09→	77			0 265 005 811		

Logan [LS]

	1.2	ABS	07.04-07.07	55	JBH	0 986 480 852	20,6	
	1.4	ABS	07.04-07.07	55	JBH	0 986 480 852	20,6	
	1.5 dCi	ABS	06.05-07.07	48/50/63	JBH	0 986 480 852	20,6	
	1.6, 16V	ABS	07.04-07.07	64/77	JBH	0 986 480 852	20,6	
	1.2		07.04→	55		0 265 232 719 ^B		
	1.4		07.04→	55		0 265 232 719 ^B		
	1.5 dCi		06.05→	48/50/55/63/65		0 265 232 719 ^B		
	1.6, 16V		07.04→	62/64/77		0 265 232 719 ^B		

Logan MCV [KS/FS]

	1.4	ABS	01.07-03.07	55	JBH,KOB JBH,VAN	0 986 481 001 0 986 481 001	22,2 22,2	
			01.07-08.07	55	JBH,KOB	0 986 480 852	20,6	
	1.5 dCi	ABS	01.07-03.07	50/63	JBH,KOB JBH,VAN	0 986 481 001 0 986 481 001	22,2 22,2	
			01.07-08.07	50/63	JBH,KOB	0 986 480 852	20,6	
	1.6	ABS	01.07-03.07	64	JBH,KOB JBH,VAN	0 986 481 001 0 986 481 001	22,2 22,2	
			01.07-08.07	64	JBH,KOB	0 986 480 852	20,6	
	1.6 16V	ABS	01.07-03.07	77	JBH	0 986 481 001	22,2	
	1.4		01.07-02.07	55		0 265 232 719 ^B		
			03.07→	55		0 265 232 111 ^B		
	1.5 dCi		01.07-02.07	50 63		0 265 232 719 ^B 0 265 232 719 ^B		

		S							
1.5 dCi		03.07→	50				0 265 232 111 ^B		
			63				0 265 232 111 ^B		
		11.10→	55				0 265 232 719 ^B		
			65				0 265 232 719 ^B		
1.6		11.10→	62				0 265 232 719 ^B		
1.6		01.07-02.07	64/77				0 265 232 719 ^B		
1.6 16V		03.07→	64/77				0 265 232 111 ^B		
Logan Pick-Up [US]									
									
	1.5 dCi	01.07→	50/55/63/65				0 265 232 719 ^B		
	1.6	01.07→	62/64				0 265 232 719 ^B		
Sandero [BS]									
									
	1.2	06.08→	55				0 265 232 719 ^B		
	1.4	06.08→	55				0 265 232 719 ^B		
	1.5 dCi	06.08→	48				0 265 232 111 ^B		
			55/63/65				0 265 232 719 ^B		
	1.6	06.08→	62/64/77				0 265 232 719 ^B		
	1.6 16V								
Serie 1300									
									
	1310 1.3, 1.4	01.79-12.98	40/48		AS2		0 204 131 029 ^A		
	1325 1.4 Liberta	12.88-12.96	48		AS2		0 204 131 029 ^A		
DAEWOO									
Espero [KLEJ]									
									
	1.5 i	01.95-10.99	66	Fg.-Nr. →951024			F 026 A02 562		
				Fg.-Nr. 951025→			F 026 A06 055		
	1.8 i	01.95-10.99	66-70	Fg.-Nr. →951024			F 026 A02 562		
				Fg.-Nr. 951025→			F 026 A06 055		
	2.0 i	01.95-10.99	77	Fg.-Nr. →951024			F 026 A02 562		
				Fg.-Nr. 951025→			F 026 A06 055		
Evanda									
									
	2.0 i	03.03-09.04	96		TKO		F 01G 19B 0HV		
		03.03-01.05	96		TKO		F 01G 19B 0HU		
		10.04-01.05	96		TKO		F 01G 160 028		
	2.0 i	03.03-01.05	96		LLE		F 01G 09B 169		
	2.0 i	03.03-01.05	96				F 026 A06 055		
Korando [KJ]									
									
	2.0 i 16V	07.96-04.98	94				0 265 217 013 ^E		
	2.3D	07.96-04.98	57				0 265 217 013 ^E		



			S								
DAEWOO Korando [KJ]											
	2.3 i 16V		07.96-04.98	103-105				0 265 217 013 ^E			
			07.96-12.00	103-105				0 265 215 008 ^H			
	2.9 D, TD Intercooler		07.96-04.98	70-73/95				0 265 217 013 ^E			
	3.2 i 24V		07.96-04.98	162				0 265 217 013 ^E			
	2.0 i 16V		07.96-12.00	94				0 265 109 047 ^K			
		2.3 D, i 16V		07.96-12.00	57/103-105			0 265 109 047 ^K			
	2.9 D, TD Intercooler		07.96-12.00	70-73/95				0 265 109 047 ^K			
	3.2 i 24V		07.96-12.00	162				0 265 109 047 ^K			
Lacetti [J200]											
	1.6 i		03.04-01.05	80				0 265 216 875 ^B			
								0 265 220 651 ^F			
	1.8 i		03.04-01.05	90				0 265 216 875 ^B			
								0 265 220 651 ^F			
Lacetti [T200]											
	1.4 i		03.04-01.05	70				0 265 216 875 ^B			
								0 265 220 651 ^F			
Lanos Hatchback [T100]											
	1.4 i	ABO	04.97-09.03	55	Fg.-Nr. →447433	GS,JBH	0 986 481 041	20,64			
		ABS	04.97-09.03	55	Fg.-Nr. →447433	GS,JBH	0 986 480 996	22			
	1.5 i	ABO	11.96-09.03	63	Fg.-Nr. →447433	AG,JBH	0 986 481 040	20,64			
							GS,JBH	0 986 481 041	20,64		
	1.6 i	ABO	04.97-09.03	78			AG,JBH	0 986 481 039	22,2		
		ABS	04.97-09.03	78	Fg.-Nr. →447433	AG,JBH	0 986 480 867				
	1.4 i		04.97-09.03	55	Fg.-Nr. 371633→	RLE	F 026 A05 957				
	1.5 i		11.96-09.03	63	Fg.-Nr. 371633→	RLE	F 026 A05 957				
	1.6 i		04.97-09.03	78	Fg.-Nr. 371633→	RLE	F 026 A05 957				
	1.4 i		04.97-09.03	55			F 026 A06 055				
	1.5 i		11.96-09.03	63			F 026 A06 055				
	1.6 i		04.97-09.03	78			F 026 A06 055				
Lanos II											
	1.5 i	ABO	04.00-12.00	71		AG	F 026 A06 497				
			04.00-03.03	71			GS	F 026 A05 885			
		ABS	04.00-12.00	71				F 026 A06 496			
Lanos [T100]											
	1.4 i	ABO	04.97-09.03	55	Fg.-Nr. →447433	GS,JBH	0 986 481 041	20,64			
		ABS	04.97-09.03	55	Fg.-Nr. →447433	GS,JBH	0 986 480 996	22			
	1.5 i	ABO	11.96-09.03	63/74	Fg.-Nr. →447433	AG,JBH	0 986 481 040	20,64			
							GS,JBH	0 986 481 041	20,64		
	1.6 i	ABO	04.97-09.03	78			AG,JBH	0 986 481 039	22,2		
		ABS	04.97-09.03	78	Fg.-Nr. →447433	AG,JBH	0 986 480 867				





	1.4 i	04.97-09.03	55	Fg.-Nr. 371633→	RLE	F 026 A05 957	
	1.5 i	11.96-09.03	63/74	Fg.-Nr. 371633→	RLE	F 026 A05 957	
	1.6 i	04.97-09.03	78	Fg.-Nr. 371633→	RLE	F 026 A05 957	
	1.4 i	04.97-09.03	55			F 026 A06 055	
	1.5 i	11.96-09.03	63/74			F 026 A06 055	
	1.6 i	04.97-09.03	78			F 026 A06 055	

Leganza [V100]

	2.0 i	MFD 03.97-12.02	98-117		LLE	F 01G 19B OHS	
		OFD 03.97-12.02	98-117		LLE	F 01G 19B OHP	
					RLE	F 01G 19B OHR	
	2.2 i	MFD 09.98-12.01	100		LLE	F 01G 19B OHS	
		OFD 09.98-12.01	100		LLE	F 01G 19B OHP	
					RLE	F 01G 19B OHR	
	1.8 i	03.97-12.02	66-70/100			0 265 220 460 ^E	
	2.0 i	03.97-12.02	93/98-117			0 265 220 460 ^E	
	2.2 i	09.98-12.01	100			0 265 220 460 ^E	
	2.0 i	03.97-12.02	66-70/100			1 273 004 249 ^H	
						1 273 004 251 ^J	
		03.97-12.02	93/98-117			1 273 004 249 ^H	
						1 273 004 251 ^J	

Matiz

	0.8	ABO 01.01→	37,5	Fg.-Nr. →577030	JBH	0 986 481 037	20,64
				Fg.-Nr. 577031→		F 026 A05 901	
		ABS 01.01→	37,5	Fg.-Nr. →577030	JBH	0 986 481 038	20,64
	0.8 i	11.98-02.02	38		JBH	0 986 481 043	20,64
	1.0	ABO 01.01→	47	Fg.-Nr. →577030	JBH	0 986 481 037	20,64
				Fg.-Nr. 577031→		F 026 A05 901	
		ABS 01.01→	47	Fg.-Nr. →577030	JBH	0 986 481 038	20,64
	0.8	01.01→	37,5	Fg.-Nr. →521401		0 265 216 990 ^B	

Matiz [M100]

	0.8 i	ABO 04.98-01.05	38	Fg.-Nr. →577030	JBH	0 986 481 037	20,64
				Fg.-Nr. 577031→		F 026 A05 901	
		ABS 04.98-01.05	38	Fg.-Nr. →577030	JBH	0 986 481 038	20,64
	1.0 i	ABO 01.03-01.05	47	Fg.-Nr. →577030	JBH	0 986 481 037	20,64
				Fg.-Nr. 577031→		F 026 A05 901	
		ABS 01.03-01.05	47	Fg.-Nr. →577030	JBH	0 986 481 038	20,64
	0.8 i	04.98-01.05	38	Fg.-Nr. →521401		0 265 216 990 ^B	

Musso [FJ]

	2.0 i 16V	05.96-04.98	100		TKO	0 265 217 013 ^E	
	2.3 D, i 16V	04.96-04.98	57/103		TKO	0 265 217 013 ^E	
	2.9 D, TD Intercooler	04.96-04.98	72/88		TKO	0 265 217 013 ^E	
	3.2 i 24V	04.96-04.98	162		TKO	0 265 217 013 ^E	





◀ DAEWOO Musso [FJ]

	2.0 i 16V	09.96-12.00	100		0 265 109 047 ^K	
	2.3 D, i 16V	09.96-12.00	57/103		0 265 109 047 ^K	
	2.9 D, TD Intercooler	09.96-12.00	72/88		0 265 109 047 ^K	
	3.2 i 24V	09.96-12.00	162		0 265 109 047 ^K	

New Prince



	2.0 i	04.96-02.97	85		0 265 215 010 ^B	
--	-------	-------------	----	--	----------------------------	--

	2.0 i	04.96-02.97	85		0 273 004 174 ^H	
--	-------	-------------	----	--	----------------------------	--

Nexia



	1.5 i	ABS 01.95→	55/62,5	RLE	F 026 A01 657	
--	-------	------------	---------	-----	---------------	--

	1.5 i	01.95→	55/62,5		F 026 A06 055	
--	-------	--------	---------	--	---------------	--

Nexia Hatchback [KLETN]



	1.5 i	ABS 11.94-08.97	44/52/55-57/ 66-67	RLE	F 026 A01 657	
--	-------	-----------------	-----------------------	-----	---------------	--

	1.5 i	11.94-08.97	44/52/55-57/ 66-67		F 026 A06 055	
--	-------	-------------	-----------------------	--	---------------	--

Nexia [KLETN]



	1.5 i	ABS 11.94-08.97	44/52/55-57/ 66-67	RLE	F 026 A01 657	
--	-------	-----------------	-----------------------	-----	---------------	--

	1.5 i	11.94-08.97	44/52/55-57/ 66-67		F 026 A06 055	
--	-------	-------------	-----------------------	--	---------------	--

Nubira Hatchback [J100]



	1.6 i	ABO 09.97-09.99	78	JBH,RLE	0 986 481 039	22,2
		ABS 09.97-09.99	78	JBH,RLE	0 986 480 867	

	2.0 i	ABO 09.97-09.99	98	JBH,RLE	0 986 481 039	22,2
		ABS 09.97-09.99	98	JBH,RLE	0 986 480 867	

























Nubira [J100]



	1.6 i	ABO 09.97-09.99	78	JBH,RLE	0 986 481 039	22,2
		ABS 09.97-09.99	78	JBH,RLE	0 986 480 867	

	2.0 i	ABO 09.97-09.99	98	JBH,RLE	0 986 481 039	22,2
		ABS 09.97-09.99	98	JBH,RLE	0 986 480 867	



									
Nubira [J150]									
									
	1.6 i	ABO	10.99-06.03	76-78		JBH,RLE,T35	0 986 481 039	22,2	
		ABS	10.99-06.03	76-78		JBH,RLE	0 986 480 867		
	2.0 i	ABO	10.99-06.03	79/98		JBH,RLE,T35	0 986 481 039	22,2	
		ABS	10.99-06.03	79/98		JBH,RLE	0 986 480 867		
	1.6 i		10.99-06.03	76-78		RLE	F 026 A06 894		
	2.0 i		10.99-06.03	79/98		RLE	F 026 A06 894		
	1.6 i		10.99-06.03	76-78			F 026 A02 562		
	2.0 i		10.99-06.03	79/98			F 026 A02 562		
Nubira [J200]									
									
	1.6 i		07.03-01.05	80			0 265 216 875 ^B		
							0 265 220 651 ^F		
	1.8 i		07.03-01.05	90			0 265 216 875 ^B		
							0 265 220 651 ^F		
Nubira Station Wagon [J100]									
									
	1.6 i	ABS	09.97-09.99	78		JBH,RLE	0 986 480 867		
	2.0 i	ABS	09.97-09.99	98		JBH,RLE	0 986 480 867		
Nubira Station Wagon [J150]									
									
	1.6 i	ABO	10.99-06.03	76-78		JBH,RLE,T35	0 986 481 039	22,2	
		ABS	10.99-06.03	76-78		JBH,RLE	0 986 480 867		
	2.0 i	ABO	08.99-06.03	98		JBH,RLE,T35	0 986 481 039	22,2	
		ABS	08.99-06.03	98		JBH,RLE	0 986 480 867		
	1.6 i		10.99-06.03	76-78		RLE	F 026 A06 894		
	2.0 i		08.99-06.03	98		RLE	F 026 A06 894		
	1.6 i		10.99-06.03	76-78			F 026 A02 562		
	2.0 i		08.99-06.03	98			F 026 A02 562		
Nubira Station Wagon [J200]									
									
	1.6 i		03.04-01.05	80			0 265 216 875 ^B		
							0 265 220 651 ^F		
	1.8 i		03.04-01.05	90			0 265 216 875 ^B		
							0 265 220 651 ^F		
Rezzo [U100]									
									
	1.6 i		09.00-01.05	74-77		RLE	F 01G 09C 1D2		
		ABO	09.00-01.05	74-77		LLE			F 01G 19C 084 ⁶
		ABS	09.00-01.05	74-77		LLE	F 01G 19B 0JB		
	1.8 i		09.00-01.05	71-77		RLE	F 01G 09C 1D2		
		ABO	09.00-01.05	71-77		LLE			F 01G 19C 084 ⁶
		ABS	09.00-01.05	71-77		LLE	F 01G 19B 0JB		
	2.0 i		09.00-01.05	88-89		RLE	F 01G 09C 1D2		
		ABO	09.00-01.05	88-89		LLE			F 01G 19C 084 ⁶
		ABS	09.00-01.05	88-89		LLE	F 01G 19B 0JB		





DAIHATSU

Charade [G2]

	1.0	06.93-12.95	36,4	STB	F 026 A01 617	
	1.3 i	06.93-04.96	62	STB	F 026 A01 617	

Copen [81]

	1.3	10.05→	64	LLE	F 01G 062 051	F 01G 062 057⁶
	1.3	10.05→	64	LLE	F 01G 061 0GV	

Cuore [L2]

	1.0 i	MFD 04.07→	51	LLE	0 204 023 750	
				RLE	0 204 023 642	
	1.0 i	MFD 04.07→	51	LLE,TW	0 204 023 832	
				RLE,TW		0 204 023 833
	1.0 i	04.07-06.11	51		0 265 231 962^B	
		04.07→	51	AG	0 265 234 653^T	
				GS	0 265 234 651^T	
		07.11→	51		0 265 252 188^B	

Delta

	3.0 D	09.87-12.94	63	TRV	F 026 A01 619	
	3.7 D	01.89-04.95	85	TRV	F 026 A01 619	
	3.7 D	01.89-04.95	85		F 026 A01 615	

Materia

	1.3	09.06→	67		0 204 023 528	
	1.5	MFD 09.06→	76	LLE	0 204 023 530	
				RLE	0 204 023 554	
		OFD 09.06→	76	LLE	0 204 023 528	
				RLE	0 204 023 552	
	1.5 4WD	09.06→	76		0 204 023 528	
	1.3	09.06→	67		0 204 023 610	
	1.5	MFD 09.06→	76	LLE	0 204 023 612	
				RLE	0 204 023 826	
		OFD 09.06→	76	LLE	0 204 023 610	
				RLE	0 204 023 613	
	1.5 4WD	09.06→	76		0 204 023 610	





Sirion II [M3]

	1.0		10.04→	51		TW	0 204 023 437	
							0 204 023 524	
							0 204 023 526	
							0 204 023 528	
							0 204 023 552	
	1.3		10.04→	67-75		TW	0 204 023 524	
							0 204 023 526	
							0 204 023 528	
							0 204 023 530	
							0 204 023 552	
							0 204 023 554	
	1.3 4WD		02.06→	67		TW	0 204 023 528	
	1.5		06.07→	76		TW	0 204 023 526	
							0 204 023 528	
							0 204 023 530	
							0 204 023 552	
							0 204 023 554	

	1.0		10.04→	51		TW	0 204 023 610	
							0 204 023 611	
							0 204 023 613	
								0 204 023 821
	1.3		10.04→	67-75		TW	0 204 023 610	
							0 204 023 611	
							0 204 023 612	
							0 204 023 613	
							0 204 023 826	
								0 204 023 821
	1.3 4WD		02.06→	67		TW	0 204 023 610	
	1.5		06.07→	76		TW	0 204 023 610	
							0 204 023 611	
							0 204 023 612	
							0 204 023 613	
							0 204 023 826	
								0 204 023 821

YRV

	1.3 i		07.01-11.02	66			F 026 A01 750	
--	--------------	--	-------------	----	--	--	---------------	--

DODGE

Caravan [RS]

	2.4	ABS	09.04-08.07	111		STB	0 204 032 656	
		ASR	09.04-08.05	111		4SB,TW	0 204 032 656	
	3.3	ABS	09.04-08.07	128-134		STB	0 204 032 656	
		ASR	09.04-08.05	128-134		4SB,TW	0 204 032 656	
	3.3 4x4	ASR	09.04-08.05	128-134		TW	0 204 032 656	
	3.8	ABS	09.04-08.07	160		STB	0 204 032 656	
		ASR	09.04-08.05	160		4SB,TW	0 204 032 656	
	3.8 4x4	ASR	09.04-08.05	153		TW	0 204 032 656	
				160		TW	0 204 032 656	



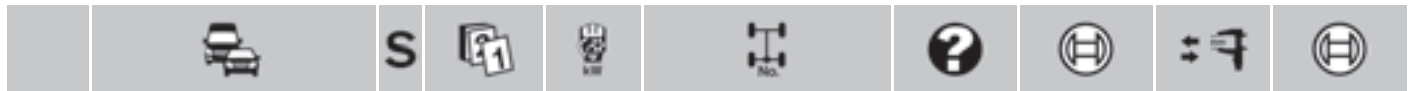

◀ DODGE

Journey [JC]



	2.0 CRD	09.09-08.10	103		RLE	0 204 707 685	
	2.4	09.09-08.10	125		RLE	0 204 707 685	
	2.7 FlexFuel	09.09-08.10	136		RLE	0 204 707 685	
	3.5, 4x4	09.09-08.10	173		RLE	0 204 707 685	

Neon [PL]



	1.6	09.00-08.05	85		TW	0 204 787 047	
	2.0	09.99-08.05	98/112		TW	0 204 787 047	
	2.4 SRT-4	09.02-08.05	160		TW	0 204 787 047	

FERRARI

456



	GT/GTR 48V	03.96-12.04	325			0 265 218 024^J	
--	-------------------	-------------	-----	--	--	----------------------------------	--

512



	TR	01.92-10.94	315			0 265 205 016^H	
--	-----------	-------------	-----	--	--	----------------------------------	--





















FIAT

Albea [172]



	1.2 i.e. 8V	ABO	01.02-06.02	44	Ricam.Nr →6310866	JBH	BSY	0 204 032 609				
			01.02-12.12	44		JBH	ATE	0 986 481 020	22,2			
			07.02-12.12	44	Ricam.Nr 6310867→	JBH	BSY	F 026 003 671	22,2			
	1.2 i.e. 8V, i.e. 16V, i.e. 16V LPG	ABS	01.02-12.12	44/57-59			JBH	BSY	F 026 003 604	22,2		
				1.2 i.e. 16V	ABO	01.02-06.02	59	Ricam.Nr →6310866	JBH	BSY	0 204 032 609	
						01.02-12.12	59		JBH	ATE	0 986 481 020	22,2
	1.2 i.e. 16V LPG	ABO	07.05-12.12	57-59			JBH	BSY	F 026 003 671	22,2		
							JBH	ATE	0 986 481 020	22,2		
							JBH	BSY	F 026 003 671	22,2		
	1.3 JTD 16V	ABO	07.03-12.12	52			JBH	ATE	0 986 481 020	22,2		
							JBH	BSY	F 026 003 671	22,2		
							JBH	BSY	F 026 003 604	22,2		
1.4 i.e. 8V	ABO	07.06-12.12	57			JBH	ATE	0 986 481 020	22,2			
						JBH	BSY	F 026 003 671	22,2			
						JBH	BSY	F 026 003 604	22,2			
1.6 i.e. 16V	ABO	01.02-06.02	76	Ricam.Nr →6310866	JBH	BSY	0 204 032 609					
				01.02-12.12	76		JBH	ATE	0 986 481 020	22,2		
				07.02-12.12	76	Ricam.Nr 6310867→	JBH	BSY	F 026 003 671	22,2		
				ABS	01.02-12.12	76		JBH	BSY	F 026 003 604	22,2	

	1.2 i.e. 8V	ABO	01.02-06.02	44	Ricam.Nr →6310866		BSY	0 204 032 622		
			07.02-12.12	44	Ricam.Nr 6310867→		BSY	0 204 125 807		
	1.2 i.e. 8V, i.e. 16V, i.e. 16V LPG	ABS	01.02-12.12	44/57-59				BSY	0 204 125 806	
				1.2 i.e. 16V	ABO	01.02-06.02	59	Ricam.Nr →6310866		BSY
	07.02-12.12	59	Ricam.Nr 6310867→				BSY	0 204 125 807		
	1.2 i.e. 16V LPG	ABO	07.05-12.12	57-59				BSY	0 204 125 807	

		S							
	1.3 JTD 16V	ABO 07.03-12.12	52			BSY	0 204 125 807		
		ABS 07.03-12.12	52			BSY	0 204 125 806		
	1.4 i.e. 8V	ABO 07.06-12.12	57			BSY	0 204 125 807		
		ABS 07.06-12.12	57			BSY	0 204 125 806		
	1.6 i.e. 16V	ABO 01.02-06.02	76	Ricam.Nr →6310866		BSY	0 204 032 622		
		07.02-12.12	76	Ricam.Nr 6310867→		BSY	0 204 125 807		
		ABS 01.02-12.12	76			BSY	0 204 125 806		
	1.3 JTD 16V	07.03-12.12	52				0 986 486 556	20,6	
	1.2 i.e. 8V, i.e. 16V, i.e. 16V LPG	01.02-12.12	44/57-59				0 204 031 199^A		
	1.3 JTD 16V	07.03-12.12	52				0 204 031 199^A		
	1.4 i.e. 8V	07.06-12.12	57				0 204 031 199^A		
	1.6 i.e. 16V	01.02-12.12	76				0 204 031 199^A		
	1.2 i.e. 16V, i.e. 16V LPG	01.02-12.12	57-59				0 265 216 828^B		
	1.3 JTD 16V	07.03-12.12	52				0 265 216 828^B		
	1.4 i.e. 8V	07.06-12.12	57				0 265 216 828^B		
	1.6 i.e. 16V	01.02-12.12	76				0 265 216 828^B		
Barchetta [183]									
									
	1.8 i.e. 16V	01.95-02.05	96				0 204 122 267	22,22	
	1.8 i.e. 16V	01.95-02.05	96				0 204 125 467		
	1.8 i.e. 16V	ABO 01.95-02.05	96			LAB	0 204 131 233^A		
						RAB	0 204 131 234^A		
		ABS 01.95-02.05	96			RAB	0 986 482 038		
		09.97-02.05	96			LAB	0 986 482 037		
	1.8 i.e. 16V	01.95-09.00	96	Ricam.Nr →26799			0 265 204 004^B		
		04.97-05.99	96	Ricam.Nr 26800→43319			0 265 216 504^B		
		06.99-09.00	96	Ricam.Nr 43320→			0 265 216 713^B		
		10.00-02.05	96				0 265 216 713^B		
	1.8 i.e. 16V	04.97-05.99	96	Ricam.Nr 26800→43319			1 273 004 242^H		
Brava									
									
	1.6 MPI 16V	04.00-09.02	78				0 204 125 601^S		
							0 204 125 724		
Brava [182 MY 95]									
									
	1.4 12V	10.95-03.98	55/59			RLE	0 204 122 268	22,22	
		10.95-10.98	55/59			JBH,LLE	F 026 003 528	22,2	
	1.6 16V	10.95-03.98	66/75/76			RLE	0 204 122 268	22,22	
		10.95-10.98	66/75/76			JBH,LLE	F 026 003 528	22,2	
	1.8 16V	10.95-03.98	83			RLE	0 204 122 268	22,22	
		10.95-10.98	83			JBH,LLE	F 026 003 528	22,2	
	1.9 D	10.95-03.98	48			JBH,LLE	F 026 003 528	22,2	
	1.9 TD	03.96-03.98	55/73,6			JBH,LLE	F 026 003 528	22,2	
		10.96-03.98	55/73,6			RLE	0 204 122 268	22,22	





◀ FIAT Brava [182 MY 95]

	1.4 12V	10.95-03.98	55/59		LLE	0 204 125 436	
		10.95-10.98	55/59		RLE	0 204 125 602 ^S	
		04.98-10.98	55/59		LLE	0 204 125 601 ^S	
1.6 16V	10.95-03.98	66/75/76		LLE	0 204 125 436		
	10.95-10.98	66/75/76		RLE	0 204 125 602 ^S		
	04.98-10.98	66/75/76		LLE	0 204 125 601 ^S		
1.8 16V	10.95-03.98	83		LLE	0 204 125 436	0 204 120 995	
	10.95-10.98	83		RLE	0 204 125 602 ^S		
	04.98-10.98	83		LLE	0 204 125 601 ^S		
1.9 D	10.95-03.98	48		LLE	0 204 125 436		
	04.98-10.98	48		LLE	0 204 125 601 ^S		
1.9 TD	03.96-03.98	55/73,6		LLE	0 204 125 436		
	03.96-10.98	55/73,6		RLE	0 204 125 602 ^S		
	04.98-10.98	55/73,6		LLE	0 204 125 601 ^S		

	1.4 12V	10.95-10.98	59		RLE	F 026 005 092	19
	1.6 16V	10.95-10.98	75		RLE	F 026 005 092	19
	1.8 16V	10.95-10.98	83		RLE	F 026 005 092	19
	1.9 TD	03.96-10.98	55/73,6		RLE	F 026 005 092	19

	1.4 12V	10.95-10.98	59		RLE	F 026 005 587	25,4
	1.6 16V	10.95-10.98	75		RLE	F 026 005 581	25,4
	1.8 16V	10.95-10.98	83		RLE	F 026 005 587	25,4
	1.9 TD	03.96-10.98	55/73,6		RLE	F 026 005 581	25,4















	1.4 12V	ABS	10.95-09.97	55/59	Ricam.Nr →4510066	0 204 131 221 ^A	
	1.6 16V		10.95-09.97	66/75/76	Ricam.Nr →4510066	0 204 131 221 ^A	
	1.8 16V		10.95-09.97	83	Ricam.Nr →4510066	0 204 131 221 ^A	
	1.9 D	ABS	10.95-09.97	48	Ricam.Nr →4510066	0 204 131 221 ^A	
	1.9 TD		03.96-09.97	55/73,6	Ricam.Nr →4510066	0 204 131 221 ^A	

Brava [182 MY 98]

	1.2 16V	11.98-09.01	60		JBH,LLE	F 026 003 528	22,2
					RLE	0 204 123 531	22,22
	1.6 16V	11.98-12.01	75/77		JBH,LLE	F 026 003 528	22,2
					RLE	0 204 122 268	22,22
	1.8 16V	11.98-07.99	83	Ricam.Nr →4873621	RLE	0 204 122 268	22,22
		11.98-09.01	83		JBH,LLE	F 026 003 528	22,2
		08.99-09.01	83	Ricam.Nr 4873622→	RLE	0 204 123 531	22,22
	1.9 JTD	11.98-09.01	74/77		JBH,LLE	F 026 003 528	22,2
	1.9 TD				RLE	0 204 122 268	22,22
	1.9 TD	11.98-09.01	55		JBH,LLE	F 026 003 528	22,2

	1.2 16V	11.98-09.01	60		LLE	0 204 125 601 ^S	
					RLE	0 204 125 724	
	1.6 16V	11.98-12.01	75/77		LLE	0 204 125 729	
					LLE	0 204 125 601 ^S	
	1.8 16V	11.98-12.01	75/77		RLE	0 204 125 724	
		11.98-07.99	83	Ricam.Nr →4873621	RLE	0 204 125 602 ^S	
		11.98-09.01	83		LLE	0 204 125 601 ^S	
	1.9 JTD	08.99-09.01	83	Ricam.Nr 4873622→	RLE	0 204 125 724	
		11.98-09.01	55/74/77		LLE	0 204 125 729	
	1.9 TD				LLE	0 204 125 601 ^S	
					RLE	0 204 125 724	
					RLE	0 204 125 602 ^S	

	1.2 16V	11.98-09.01	60		RLE	F 026 005 092	19
		08.00-09.01	60		LLE	F 026 005 119	19
	1.6 16V	11.98-09.01	75		RLE	F 026 005 092	19

		S							
1.8 16V		11.98-09.01	83			RLE	F 026 005 092	19	
1.9 JTD		11.98-09.01	77			LLE	F 026 005 095	19	
						RLE	F 026 005 092	19	
		08.00-09.01	74			LLE	F 026 005 119	19	
1.9 JTD, TD		11.98-09.01	74			RLE	F 026 005 092	19	
1.9 TD		11.98-09.01	55			RLE	F 026 005 092	19	
 1.2 16V		11.98-09.01	60			RLE	F 026 005 587	25,4	
		08.00-09.01	60				F 026 005 587	25,4	
1.6 16V		11.98-09.01	75				F 026 005 581	25,4	
		10.99-09.01	75			RLE	F 026 005 581	25,4	
1.8 16V		11.98-09.01	83				F 026 005 581	25,4	
1.9 JTD, TD		11.98-09.01	55/74/77				F 026 005 581	25,4	
 1.6 16V		11.98-12.01	75/77				0 204 131 221^A		
1.8 16V		11.98-09.01	83				0 204 131 221^A		
1.9 JTD, TD		11.98-09.01	55/74/77				0 204 131 221^A		
Bravo [182 MY95]									
									
 1.4 12V		10.95-10.98	55/59			JBH, LLE	F 026 003 528	22,2	
						RLE	0 204 122 268	22,22	
1.6 16V		10.95-10.98	66/75			JBH, LLE	F 026 003 528	22,2	
1.8 16V		10.95-10.98	83			JBH, LLE	F 026 003 528	22,2	
						RLE	0 204 122 268	22,22	
1.9 D		10.95-10.98	48			JBH, LLE	F 026 003 528	22,2	
1.9 TD		03.96-10.98	55/73,6			JBH, LLE	F 026 003 528	22,2	
						RLE	0 204 122 268	22,22	
2.0 20V		10.95-10.98	108			RLE	0 204 123 523	22,22	
 1.4 12V		10.95-03.98	55/59			LLE	0 204 125 436		
		10.95-10.98	55/59			RLE	0 204 125 602^S		
		04.98-10.98	55/59			LLE	0 204 125 601^S		
							0 204 125 724		
1.6 16V		10.95-03.98	66/75			LLE	0 204 125 436		
		04.98-10.98	66/75			LLE	0 204 125 601^S		
							0 204 125 724		
1.8 16V		10.95-03.98	83			LLE	0 204 125 436		
		10.95-10.98	83			RLE	0 204 125 602^S		
		04.98-10.98	83			LLE	0 204 125 601^S		
							0 204 125 724		
1.9 D		10.95-03.98	48			LLE	0 204 125 436		
		10.95-10.98	48			LLE	0 204 125 601^S		
		04.98-10.98	48			LLE	0 204 125 724		
1.9 TD		03.96-03.98	55			LLE	0 204 125 436		
			73,6			LLE	0 204 125 436		
		03.96-10.98	55			LLE	0 204 125 601^S		
						RLE	0 204 125 602^S		
			73,6			LLE	0 204 125 601^S		
						RLE	0 204 125 602^S		
		04.98-10.98	55			LLE	0 204 125 724		
			73,6			LLE	0 204 125 724		
2.0 20V		10.95-10.98	108			LLE	0 204 125 431^S		
 1.4 12V		10.95-10.98	59			RLE	F 026 005 092	19	
1.6 16V		10.95-10.98	75			RLE	F 026 005 092	19	
1.8 16V		10.95-10.98	83			RLE	F 026 005 092	19	
1.9 D, TD		10.95-10.98	48/55/73,6			RLE	F 026 005 092	19	
2.0 20V		10.95-10.98	108				F 026 005 095	19	





FIAT Bravo [182 MY95]

	1.4 12V		10.95-10.98	59		RLE	F 026 005 587	25,4
	1.6 16V		10.95-10.98	75		RLE	F 026 005 581	25,4
	1.8 16V		10.95-10.98	83		RLE	F 026 005 581	25,4
	1.9 D, TD		10.95-10.98	48/55/73,6		RLE	F 026 005 581	25,4
	2.0 20V		10.95-10.98	108			F 026 005 581	25,4
	1.4 12V	ABS	10.95-09.97	55/59	Ricam.Nr →4510066		0 204 131 221^A	
	1.6 16V		10.95-09.97	66/75	Ricam.Nr →4510066		0 204 131 221^A	
	1.8 16V		10.95-09.97	83	Ricam.Nr →4510066		0 204 131 221^A	
	1.9 D	ABS	10.95-09.97	48	Ricam.Nr →4510066		0 204 131 221^A	
	1.9 TD		03.96-09.97	55/73,6	Ricam.Nr →4510066		0 204 131 221^A	
	2.0 20V		10.95-09.97	108	Ricam.Nr →4510066		0 204 131 221^A	

Bravo [182 MY98]





















	1.2 16V		11.98-09.01	60		JBH,LLE	F 026 003 528	22,2
						RLE	0 204 123 531	22,22
	1.6 16V		11.98-09.01	75		JBH,LLE	F 026 003 528	22,2
						RLE	0 204 122 268	22,22
	1.8 16V		11.98-07.99	83	Ricam.Nr →4873621	RLE	0 204 122 268	22,22
			11.98-09.01	83		JBH,LLE	F 026 003 528	22,2
			08.99-09.01	83	Ricam.Nr 4873622→	RLE	0 204 123 531	22,22
	1.9 JTD		11.98-09.01	55/74/77		JBH,LLE	F 026 003 528	22,2
1.9 TD					RLE	0 204 122 268	22,22	
2.0 20V		11.98-09.01	113		RLE	0 204 123 523	22,22	

	1.2 16V		11.98-09.01	60		LLE	0 204 125 601^S	
						RLE	0 204 125 724	
	1.6 16V		11.98-09.01	75		LLE	0 204 125 601^S	
						RLE	0 204 125 602^S	
	1.8 16V		11.98-07.99	83	Ricam.Nr →4873621	RLE	0 204 125 602^S	
			11.98-09.01	83		LLE	0 204 125 601^S	
						RLE	0 204 125 724	
			08.99-09.01	83	Ricam.Nr 4873622→	RLE	0 204 125 729	
	1.9 JTD		11.98-09.01	55/74/77		LLE	0 204 125 601^S	
	1.9 TD					RLE	0 204 125 724	
						RLE	0 204 125 602^S	
	2.0 20V		11.98-09.01	113		LLE	0 204 125 431^S	

	1.2 16V		11.98-09.01	60		RLE	F 026 005 092	19
			08.00-09.01	60		LLE	F 026 005 119	19
	1.6 16V		11.98-09.01	75		RLE	F 026 005 092	19
	1.8 16V		11.98-09.01	83		RLE	F 026 005 092	19
	1.9 JTD		11.98-09.01	77		LLE	F 026 005 095	19
						RLE	F 026 005 092	19
			08.00-09.01	74		LLE	F 026 005 119	19
	1.9 JTD, TD		11.98-09.01	74		RLE	F 026 005 092	19
	1.9 TD		11.98-09.01	55		RLE	F 026 005 092	19
	2.0 20V		11.98-09.01	113		LLE	F 026 005 095	19
						RLE	F 026 005 092	19

























	1.2 16V		11.98-09.01	60		RLE	F 026 005 587	25,4
			08.00-09.01	60			F 026 005 587	25,4
	1.6 16V		11.98-09.01	75		RLE	F 026 005 581	25,4
	1.8 16V		11.98-09.01	83		RLE	F 026 005 581	25,4
	1.9 JTD		11.98-09.01	77			F 026 005 581	25,4
			08.00-09.01	74			F 026 005 581	25,4
	1.9 TD		11.98-09.01	55		RLE	F 026 005 581	25,4
				74		RLE	F 026 005 581	25,4

		S							
	2.0 20V	11.98-09.01	113				F 026 005 581	25,4	
	1.6 16V	11.98-09.01	75				0 204 131 221 ^A		
	1.8 16V	11.98-09.01	83				0 204 131 221 ^A		
	1.9 JTD, TD	11.98-09.01	55/74/77				0 204 131 221 ^A		
Bravo [198]									
									
	1.6 Multijet	10.13→	77			SSG	0 204 123 766	23,81	
						SSG	0 204 123 765	23,81	
	1.6 Multijet	10.13→	77				0 204 808 616		
	1.6 Multijet	10.13→	77			TW	0 265 251 844 ^T		
Bravo [198 MY07]									
									
	1.4 Turbo 16V	07.07-12.09	110			GS	0 204 123 766	23,81	
						HAG	0 204 123 765	23,81	
		10.07-12.09	88				0 204 123 766	23,81	
	1.4 16V	03.07-05.07	66				0 204 123 625	22,2	
		06.07-12.09	66				0 204 123 766	23,81	
	1.4 16V LPG	03.09-12.09	66				0 204 123 766	23,81	
	1.6 Multijet	10.07-12.09	77				0 204 123 766	23,81	
		03.08-12.09	88			GS	0 204 123 766	23,81	
						HAG	0 204 123 765	23,81	
		11.08-12.09	85			SSG	0 204 123 766	23,81	
						SSG	0 204 123 765	23,81	
		02.09-12.09	66			SSG	0 204 123 766	23,81	
						SSG	0 204 123 765	23,81	
	1.9 Multijet	03.07-05.07	66/85/88				0 204 123 625	22,2	
		06.07-12.09	66/85/88				0 204 123 766	23,81	
			110				0 204 123 766	23,81	
	2.0 Multijet	10.08-12.09	120/121				0 204 123 766	23,81	
	1.4 Turbo 16V	07.07-12.09	110			GS	0 204 125 905		
						HAG	0 204 051 951 ^S		
		10.07-12.09	88				0 204 125 906		
	1.4 16V	03.07-12.09	66				0 204 125 906		
	1.4 16V LPG					Ricam.Nr →4127260	0 204 125 833		
	1.6 Multijet	10.07-12.09	66/77/85/88			Ricam.Nr 4127261→	0 204 125 906		
	1.9 Multijet	03.07-05.07	66/85/88				0 204 125 905		
		06.07-12.09	66/85/88				0 204 125 905		
			110				0 204 125 905		
	2.0 Multijet	10.08-12.09	120/121				0 204 125 905		
	1.6 Multijet	10.07-12.09	77/88			LLE	0 986 486 140	15,87	
	1.9 Multijet	03.07-12.09	66/85/88/110			LLE	0 986 486 140	15,87	
	1.4 16V	03.07-12.09	66				0 986 486 563	20,6	
	1.4 16V LPG								
	1.4 Turbo 16V	07.07-03.08	88/110				0 265 231 929 ^B		
	1.4 16V	03.07-05.07	66				0 265 235 292 ^T		
		03.07-03.08	66				0 265 231 929 ^B		
	1.6 Multijet	10.07-03.08	77/88				0 265 231 929 ^B		



		S							
FIAT Bravo [198 MY07]									
	1.9 Multijet	03.07-05.07	66/85/88/110				0 265 235 292 ^T		
		03.07-03.08	66/85/88/110				0 265 231 929 ^B		
	1.4 Turbo 16V, 16V, 16V LPG	03.07-12.09	66/88/110				0 265 005 303		
	1.6 Multijet	10.07-12.09	77/88				0 265 005 303		
	1.9 Multijet	03.07-12.09	66/85/88/110				0 265 005 303		
	2.0 Multijet	10.08-12.09	120/121				0 265 005 303		
Bravo [198 MY10]									
	1.4, LPG	03.10-07.13	66				0 204 123 792	23,81	
		1.4 Turbo	03.10-07.13	88		SSG	0 204 123 792	23,81	
				103/110		SSG	0 204 123 765	23,81	
	1.6 Multijet	01.10-07.13	66/77/88		SSG	0 204 123 792	23,81		
		01.10→	66/77/88		SSG	0 204 123 765	23,81		
		08.13→	66/77/88		SSG	0 204 123 766	23,81		
	2.0 Multijet	03.10-07.13	120		SSG	0 204 123 792	23,81		
		03.10→	120		SSG	0 204 123 765	23,81		
		08.13→	120		SSG	0 204 123 766	23,81		
		1.4, LPG, Turbo	03.10-07.13	66/88				0 204 125 906	
1.4 Turbo			03.10-07.13	103			0 204 125 905		
				110			0 204 125 906		
1.6 Multijet		01.10-07.13	66/77/88				0 204 125 905		
		08.13→	66/77/88				0 204 808 616		
2.0 Multijet		03.10-07.13	120				0 204 125 905		
	08.13→	120				0 204 808 616			
	1.4	03.10→	66				0 986 486 563	20,6	
	1.4 LPG								
	1.4, LPG, Turbo	03.10→	66/88/103/110		TW		0 265 251 844 ^T		
	1.6 Multijet	01.10→	66/77/88		TW		0 265 251 844 ^T		
	2.0 Multijet	03.10→	120		TW		0 265 251 844 ^T		
Cinquecento [170]									
	700	10.92-02.94	22		JBH		F 026 003 430	19,05	
	900, i.e	07.91-02.94	29/30/31		JBH		F 026 003 430	19,05	
	1.1 i.e	10.94-07.98	40				0 204 125 450		
	900, i.e	07.91-07.98	29/30/31				0 204 125 450		
	1.1 i.e	10.94-07.98	40				0 204 131 720		
	700	10.92-07.98	22				0 204 131 720		
	900, i.e	07.91-07.98	29/30/31				0 204 131 720		
Coupé [175 MY93]									
	1.8 i 16V	03.96-08.96	96		JBH		F 026 003 528	22,2	
	2.0 i 16V, i 16V Turbo	02.94-09.96	104/143		JBH,LLE		F 026 003 528	22,2	
	1.8 i 16V	03.96-08.96	96				0 204 125 436		
	2.0 i 16V	02.94-09.96	104/143		LLE		0 204 125 436		
	2.0 i 16V Turbo				RLE		0 204 125 476 ^S		



		S								
	1.8 i 16V	03.96-09.96	96				LLE	F 026 005 095	19	
	2.0 i 16V	04.94-09.96	104				LLE	F 026 005 095	19	
							RLE	F 026 005 092	19	
	2.0 i 16V Turbo	02.94-03.94	143				LLE	F 026 005 091	19	
		04.94-09.96	143				LLE	F 026 005 095	19	
							RLE	F 026 005 092	19	
	1.8 i 16V	03.96-09.96	96					F 026 005 581	25,4	
	2.0 i 16V	06.95-09.96	104					F 026 005 581	25,4	
	2.0 i 16V Turbo	06.95-09.96	143					0 204 163 077		
	1.8 i 16V	03.96-09.96	96					0 204 131 221^A		
	2.0 i 16V, i 16V Turbo	02.94-09.96	104/143					0 204 131 221^A		
	1.8 i 16V	03.96-09.96	96					0 265 216 425^B		
	2.0 i 16V, i 16V Turbo	02.94-09.96	104/143					0 265 208 034^B		
Coupé [175 MY96]										
										
	1.8 16V	10.96-07.99	96	Ricam.Nr →68434			JBH	F 026 003 528	22,2	
	2.0 20V, 20V Turbo	10.96-09.00	108/113/162				RLE	0 204 123 523	22,22	
	1.8 16V	10.96-07.99	96	Ricam.Nr →68434				0 204 125 436	0 204 120 995	
							LLE	0 204 125 601^S		
	1.8 16V	10.96-09.00	96					F 026 005 095	19	
	2.0 20V	10.96-09.00	108/113/162				LLE	F 026 005 095	19	
	2.0 20V Turbo						RLE	F 026 005 092	19	
	1.8 16V	10.96-09.00	96					F 026 005 581	25,4	
	2.0 20V	10.96-09.00	108/113					F 026 005 581	25,4	
	2.0 20V Turbo	10.96-09.00	162					0 204 163 077		
	1.8 16V	10.96-09.00	96					0 204 131 221^A		
	2.0 20V, 20V Turbo	10.96-09.00	108/113/162					0 204 131 221^A		
	1.8 16V	10.96-09.00	96					0 265 216 425^B		
	2.0 20V, 20V Turbo	10.96-09.00	108/113/162					0 265 216 425^B		
Croma [154 MY90]										
										
	1.9 TD i.d.	11.92-12.96	69					0 204 122 195	22,22	0 204 124 098⁷
	2.0 i.e., i.e. Turbo, i.e. 16V	05.91-12.96	85/86/101/110/117					0 204 122 195	22,22	0 204 124 098⁷
	2.5 i.e., TD, TDI	11.92-12.96	85/119					0 204 122 195	22,22	0 204 124 098⁷
	1.9 TD i.d.	11.92-12.96	69					0 204 125 409		
	2.0 i.e., i.e. Turbo	11.92-12.96	86/110/117	Ricam.Nr 0300691→			FMS	0 204 125 426		
	2.5 i.e.	06.93-12.96	119				FMS	0 204 125 426		
	2.5 TD, TDI	11.92-12.96	85					0 204 125 433^S		
	2.5 TDI	09.93-11.96	85					0 204 125 409		
	1.9 TD i.d.	11.92-12.96	69					0 204 162 081		
	2.0 i.e., i.e. Turbo, i.e. 16V	05.91-12.96	85/86/101/110/117					0 204 162 081		
	2.5 i.e., TD, TDI	11.92-12.96	85/119					0 204 162 081		
	1.9 TD i.d.	11.92-12.96	69					0 204 163 080		
	2.0 i.e.	11.92-12.96	85					F 026 005 580	25,4	
	2.0 i.e. Turbo	11.92-12.96	117					0 204 163 080		
		07.95-12.96	110	Ricam.Nr VET.0020736→				0 204 163 077		

		S							
FIAT Croma [154 MY90]									
	2.0 i.e.	05.91-12.96	86/101				F 026 005 580	25,4	
	2.0 i.e. 16V	12.92-12.96	86/101				0 204 163 080		
	2.5 i.e., TD, TDI	11.92-12.96	85/119				0 204 163 080		
	2.0 i.e., i.e. Turbo, i.e. 16V	05.91-12.96	85/86/101/ 110/117				0 204 131 202^A		
	1.9 TD i.d.	11.92-12.96	69				0 265 208 034^B		
	2.0 i.e., i.e. Turbo, i.e. 16V	03.92-12.96	85/86/101/110/117				0 265 208 034^B		
	2.5 i.e., TD, TDI	11.92-12.96	85/119				0 265 208 034^B		
Croma [194 MY05]									
	1.8 i.e.	06.05-12.10	103			JBH, LLE	0 986 480 858	25,4	
	1.9 JTD 8V, JTD 16V	06.05-12.10	85/88/100			JBH, LLE	0 986 480 858	25,4	
	1.9 JTD 16V	06.05-11.06	110			JBH, LLE	0 986 480 993	25,4	
		06.05-12.10	110			JBH, RLE	0 986 480 837		
		12.06-12.10	110			JBH, LLE	0 986 480 858	25,4	
	2.2 i.e.	06.05-11.06	108			JBH, LLE	0 986 480 993	25,4	
		06.05-12.10	108			JBH, RLE	0 986 480 837		
		12.06-12.10	108			JBH, LLE	0 986 480 858	25,4	
	2.4 JTD	06.05-11.06	147			JBH, LLE	0 986 480 993	25,4	
		12.06-12.10	147			JBH, LLE	0 986 480 858	25,4	
	1.8 i.e.	06.05-12.10	103				0 986 486 588	31	
	1.9 JTD 8V, JTD 16V	06.05-12.10	85/88/100/110				0 986 486 592	34	
	2.2 i.e.	06.05-12.10	108				0 986 486 586	34	
Doblo									
	1.9 D	ABO 11.03-01.06	46			JBH	0 986 480 866	22	
		ABS 11.03-01.06	46			JBH	0 986 480 953	22,2	
Doblo Cargo [223..]									
	1.2 i.e. 8V	07.00-09.05	48			JBH, RLE	0 986 481 005	22,2	
		ABO 07.00-09.05	48			JBH, LLE	0 986 480 866	22	
		ABS 07.00-09.05	48			JBH, LLE	0 986 480 953	22,2	
	1.3 JTD 16V	ABO 02.04-09.05	51			JBH, LLE	0 986 480 866	22	
		ABS 02.04-09.05	51			JBH, LLE	0 986 480 953	22,2	
	1.3 JTD 16V, Multijet	02.04-12.10	51/55/62			JBH, RLE	0 986 481 005	22,2	
	1.3 Multijet	ABO 10.05-12.10	55/62			LLE	0 204 123 714	23,81	
		ABS 10.05-12.10	55/62			LLE	0 204 123 713	23,81	
	1.4 i.e.	10.05->	55-57			JBH, RLE	0 986 481 005	22,2	
		ABO 10.05->	55-57			LLE	0 204 123 712	22,2	
		ABS 10.05->	55-57			LLE	0 204 123 711	22,2	
	1.6 i.e. 16V	10.01-09.05	68-76			JBH, RLE	0 986 481 005	22,2	
	1.6 i.e. 16V Bipower	ABO 10.01-09.05	68-76			JBH, LLE	0 986 480 866	22	
		ABS 10.01-09.05	68-76			JBH, LLE	0 986 480 953	22,2	
	1.9 D	ABO 07.00-09.05	46			JBH, LLE	0 986 480 866	22	
		ABS 07.00-09.05	46			JBH, LLE	0 986 480 953	22,2	
	1.9 D, JTD, Multijet	07.00-12.10	46/74/77/88			JBH, RLE	0 986 481 005	22,2	
	1.9 JTD	ABO 10.01-09.05	74/77			JBH, LLE	0 986 480 866	22	
		ABS 10.01-09.05	74/77			JBH, LLE	0 986 480 953	22,2	
	1.9 Multijet	ABO 10.05-12.10	74/77			LLE	0 204 123 714	23,81	
			88			LLE	0 204 123 714	23,81	
		ABS 10.05-12.10	74/77			LLE	0 204 123 713	23,81	
			88			LLE	0 204 123 713	23,81	



		S							
	1.3 Multijet	10.05-06.08	55/62		LLE		0 204 125 856		
	1.4 i.e.	10.05→	55-57		LLE		0 204 125 866		
	1.9 Multijet	10.05-06.08	74/77		LLE		0 204 125 856		
	1.3 JTD 16V, Multijet	02.04-12.10	51/55/62		LLE		0 986 486 091	15,87	
	1.4 i.e.	10.05→	55-57		LLE		0 986 486 091	15,87	
	1.6 i.e. 16V, i.e. 16V Bipower	10.01-09.05	68-76		LLE		0 986 486 091	15,87	
	1.9 D, JTD, Multijet	07.00-12.10	46/74/77/88		LLE		0 986 486 091	15,87	
	1.3 JTD 16V, Multijet	02.04-12.10	51/55/62				0 986 486 556	20,6	
	1.4 i.e.	10.05→	55-57		LLE		0 986 486 563	20,6	
					RLE		0 986 486 556	20,6	
	1.6 i.e. 16V	10.01-09.05	68-76		LLE		0 986 486 563	20,6	
	1.6 i.e. 16V Bipower				RLE		0 986 486 556	20,6	
	1.9 D, JTD, Multijet	07.00-12.10	46/74/77/88				0 986 486 556	20,6	
Doblo Cargo [223]									
	1.6 i.e. 16V Bipower	10.05-12.10	76		JBH,RLE		0 986 481 005	22,2	
		ABO 10.05-12.10	76		LLE		0 204 123 712	22,2	
		ABS 10.05-12.10	76		LLE		0 204 123 711	22,2	
	1.6 i.e. 16V Bipower	10.05-12.10	76		LLE		0 204 125 866		
	1.6 i.e. 16V Bipower	10.05-12.10	76		LLE		0 986 486 091	15,87	
	1.6 i.e. 16V Bipower	10.05-12.10	76				0 986 486 556	20,6	
Doblo Cargo [263]									
	1.3 Multijet	ABO 02.10→	55/66		LLE		0 204 123 818	23,81	
					RLE		0 204 123 822	23,81	
		ABS 02.10→	55/66		LLE,SSG		0 204 123 816	23,81	
					LLE,SSG		0 204 123 817	23,81	
					RLE		0 204 123 823	23,81	
		MFD 02.10→	55/66		LLE,SSG		0 204 123 820	23,81	
					LLE,SSG		0 204 123 821	23,81	
					RLE		0 204 123 824	23,81	
	1.4	ABO 02.10→	70/88		LLE		0 204 123 818	23,81	
	1.4 Natural Power				RLE		0 204 123 822	23,81	
		ABS 02.10→	70/88		LLE,SSG		0 204 123 816	23,81	
					LLE,SSG		0 204 123 817	23,81	
					RLE		0 204 123 823	23,81	
		MFD 02.10→	70/88		LLE,SSG		0 204 123 820	23,81	
					LLE,SSG		0 204 123 821	23,81	
					RLE		0 204 123 824	23,81	
	1.6 Multijet	ABO 02.10→	66/74/77		LLE		0 204 123 818	23,81	
					RLE		0 204 123 822	23,81	
		ABS 02.10→	66/74/77		LLE,SSG		0 204 123 816	23,81	
					LLE,SSG		0 204 123 817	23,81	
					RLE		0 204 123 823	23,81	
		MFD 02.10→	66/74/77		LLE,SSG		0 204 123 820	23,81	
					LLE,SSG		0 204 123 821	23,81	
					RLE		0 204 123 824	23,81	
	2.0 Multijet	ABO 02.10→	99		LLE		0 204 123 818	23,81	
					RLE		0 204 123 822	23,81	



FIAT Doblo Cargo [263]								
	2.0 Multijet	ABS	02.10→	99	LLE,SSG	0 204 123 816	23,81	
					LLE,SSG	0 204 123 817	23,81	
					RLE	0 204 123 823	23,81	
	MFD	02.10→	99	LLE,SSG	0 204 123 820	23,81		
				LLE,SSG	0 204 123 821	23,81		
				RLE	0 204 123 824	23,81		
	1.3 Multijet	02.10→	55/66	D84,LLE	0 204 125 946			
				RLE	0 204 125 950			
				305,LLE	0 204 125 947			
	1.4 1.4 Natural Power	02.10→	70/88	D84,LLE	0 204 125 946			
				RLE	0 204 125 950			
				305,LLE	0 204 125 947			
1.6 Multijet	02.10→	66/74/77	D84,LLE	0 204 125 946				
			RLE	0 204 125 950				
			305,LLE	0 204 125 947				
2.0 Multijet	02.10→	99	D84,LLE	0 204 125 946				
			RLE	0 204 125 950				
			305,LLE	0 204 125 947				
	1.3 Multijet	02.10→	55/66			0 986 486 556	20,6	
	1.3 Multijet	02.10→	55/66	ERH	0 204 031 335			
				NON	0 204 031 336			
				ERH	0 204 031 336			
	1.4 1.4 Natural Power	02.10→	70/88	NON	0 204 031 335			
				ERH	0 204 031 335			
				NON	0 204 031 336			
1.6 Multijet	02.10→	66/74/77	ERH	0 204 031 335				
			NON	0 204 031 336				
			ERH	0 204 031 335				
2.0 Multijet	02.10→	99	NON	0 204 031 336				
			ERH	0 204 031 335				
			NON	0 204 031 336				
Doblo [Fase I]								
	1.3 MPI 16V	ABO	11.01-01.06	59	JBH	0 986 480 866	22	
		ABS	11.01-01.06	59	JBH	0 986 480 953	22,2	
Doblo [223 MY00]								
	1.2 i.e. 8V		07.00-09.05	48	JBH,RLE	0 986 481 005	22,2	
		ABO	07.00-09.05	48	JBH,LLE	0 986 480 866	22	
		ABS	07.00-09.05	48	JBH,LLE	0 986 480 953	22,2	
	1.3 JTD 16V		02.04-09.05	51	JBH,RLE	0 986 481 005	22,2	
		ABO	02.04-09.05	51	JBH,LLE	0 986 480 866	22	
		ABS	02.04-09.05	51	JBH,LLE	0 986 480 953	22,2	
	1.6 i.e. 16V		10.01-09.05	68-76	JBH,RLE	0 986 481 005	22,2	
	1.6 i.e. 16V Bipower	ABO	10.01-09.05	68-76	JBH,LLE	0 986 480 866	22	
		ABS	10.01-09.05	68-76	JBH,LLE	0 986 480 953	22,2	
	1.9 D		07.00-09.05	46/74/77	JBH,RLE	0 986 481 005	22,2	
	1.9 JTD	ABO	07.00-09.05	46/74/77	JBH,LLE	0 986 480 866	22	
		ABS	07.00-09.05	46/74/77	JBH,LLE	0 986 480 953	22,2	
	1.3 JTD 16V		02.04-09.05	51	LLE	0 986 486 091	15,87	
	1.6 i.e. 16V, i.e. 16V Bipower		10.01-09.05	68-76	LLE	0 986 486 091	15,87	
	1.9 D, JTD		07.00-09.05	46/74/77	LLE	0 986 486 091	15,87	
	1.2 i.e. 8V		07.00-09.05	48	RLE	0 986 486 556	20,6	
	1.3 JTD 16V		02.04-09.05	51		0 986 486 556	20,6	
	1.6 i.e. 16V		10.01-09.05	68-76	LLE	0 986 486 563	20,6	
	1.6 i.e. 16V Bipower				RLE	0 986 486 556	20,6	
	1.9 D, JTD		07.00-09.05	46/74/77		0 986 486 556	20,6	



Doblo [223 MY05]

	1.3 Multijet	10.05-12.10	55/62	JBH,RLE	0 986 481 005	22,2
	ABO	10.05-12.10	55/62	LLE	0 204 123 714	23,81
	ABS	10.05-12.10	55/62	LLE	0 204 123 713	23,81
	1.4 i.e.	10.05→	55-57	JBH,RLE	0 986 481 005	22,2
	ABO	10.05→	55-57	LLE	0 204 123 712	22,2
	ABS	10.05→	55-57	LLE	0 204 123 711	22,2
	1.6 i.e. 16V Bipower	10.05-12.10	76	JBH,RLE	0 986 481 005	22,2
	ABO	10.05-12.10	76	LLE	0 204 123 712	22,2
	ABS	10.05-12.10	76	LLE	0 204 123 711	22,2
	1.9 Multijet	10.05-12.10	74/77/88	JBH,RLE	0 986 481 005	22,2
	ABO	10.05-12.10	74/77/88	LLE	0 204 123 714	23,81
	ABS	10.05-12.10	74/77/88	LLE	0 204 123 713	23,81

	1.3 Multijet	10.05-06.08	55/62	LLE	0 204 125 856	
	1.4 i.e.	10.05→	55-57	LLE	0 204 125 866	
	1.6 i.e. 16V Bipower	10.05-12.10	76	LLE	0 204 125 866	
	1.9 Multijet	10.05-06.08	74/77/88	LLE	0 204 125 856	

	1.3 Multijet	10.05-12.10	55/62	LLE	0 986 486 091	15,87
	1.4 i.e.	10.05→	55-57	LLE	0 986 486 091	15,87
	1.6 i.e. 16V Bipower	10.05-12.10	76	LLE	0 986 486 091	15,87
	1.9 Multijet	10.05-12.10	74/77/88	LLE	0 986 486 091	15,87















	1.3 Multijet	10.05-12.10	55/62		0 986 486 556	20,6
	1.4 i.e.	10.05→	55-57	LLE	0 986 486 563	20,6
				RLE	0 986 486 556	20,6
	1.6 i.e. 16V Bipower	10.05-12.10	76	LLE	0 986 486 563	20,6
	1.9 Multijet	10.05-12.10	74/77/88		0 986 486 556	20,6

Doblo [263]

	1.3 Multijet	ABO 02.10→	66	LLE	0 204 123 818	23,81
	1.3 Multijet DPF			RLE	0 204 123 822	23,81
		ABS 02.10→	66	LLE,SSG	0 204 123 816	23,81
				LLE,SSG	0 204 123 817	23,81
				RLE	0 204 123 823	23,81
		MFD 02.10→	66	LLE,SSG	0 204 123 820	23,81
				LLE,SSG	0 204 123 821	23,81
				RLE	0 204 123 824	23,81
	1.4	ABO 02.10→	70/88	LLE	0 204 123 818	23,81
	1.4 Natural Power			RLE	0 204 123 822	23,81
		ABS 02.10→	70/88	LLE,SSG	0 204 123 816	23,81
				LLE,SSG	0 204 123 817	23,81
				RLE	0 204 123 823	23,81
		MFD 02.10→	70/88	LLE,SSG	0 204 123 820	23,81
				LLE,SSG	0 204 123 821	23,81
				RLE	0 204 123 824	23,81
	1.6 Multijet	ABO 02.10→	66/74/77	LLE	0 204 123 818	23,81
				RLE	0 204 123 822	23,81
		ABS 02.10→	66/74/77	LLE,SSG	0 204 123 816	23,81
				LLE,SSG	0 204 123 817	23,81
				RLE	0 204 123 823	23,81
		MFD 02.10→	66/74/77	LLE,SSG	0 204 123 820	23,81
				LLE,SSG	0 204 123 821	23,81
				RLE	0 204 123 824	23,81
	2.0 Multijet	ABO 02.10→	99	LLE	0 204 123 818	23,81
				RLE	0 204 123 822	23,81



		S									
	FIAT Doblo [263]										
	2.0 Multijet	ABS	02.10→	99			LLE,SSG	0 204 123 816	23,81		
							LLE,SSG	0 204 123 817	23,81		
							RLE	0 204 123 823	23,81		
	MFD	02.10→	99				LLE,SSG	0 204 123 820	23,81		
							LLE,SSG	0 204 123 821	23,81		
							RLE	0 204 123 824	23,81		
	1.3 Multijet	02.10→	66				D84,LLE	0 204 125 946			
							RLE	0 204 125 950			
	1.3 Multijet DPF	02.10→	66					305,LLE	0 204 125 947		
	1.4	02.10→	70/88					D84,LLE	0 204 125 946		
								RLE	0 204 125 950		
1.4 Natural Power	02.10→	70/88					305,LLE	0 204 125 947			
1.6 Multijet	02.10→	66/74/77					D84,LLE	0 204 125 946			
							RLE	0 204 125 950			
							305,LLE	0 204 125 947			
2.0 Multijet	02.10→	99					D84,LLE	0 204 125 946			
							RLE	0 204 125 950			
							305,LLE	0 204 125 947			
	1.3 Multijet, Multijet DPF	02.10→	66				0 986 486 556	20,6			
	1.3 Multijet	02.10→	66				ERH	0 204 031 335			
							NON	0 204 031 336			
	1.4	02.10→	70/88					ERH	0 204 031 336		
								NON	0 204 031 335		
	1.4 Natural Power	02.10→	70/88					ERH	0 204 031 335		
								NON	0 204 031 336		
1.6 Multijet	02.10→	66/74/77					0 204 031 336				
2.0 Multijet	02.10→	99					0 204 031 335				
Ducato											
	2.5 D	ABO	11.97-12.99	62			JBH	F 026 003 313	25,4		
								ABS	11.97-12.99	62	
	2.8 D Turbo	ABS	04.00-04.02	90					F 026 003 315	25,4	
									05.02-05.05	90	
	2.8 D Turbo Interc.	ABS	10.99-04.02	103,3					F 026 003 315	25,4	
									05.02-05.05	103,3	
2.8 D Turbo, D Turbo Interc.	ABO	04.99-04.02	90/103,3				JBH	F 026 003 313	25,4		
	2.5 D		11.97-12.99	62				0 204 125 746			
								2.8 D Turbo	04.99-10.00	90	
	2.8 D Turbo		04.99-10.00	90					0 204 125 772		
									05.02-05.05	90	
	2.8 D Turbo Interc.		10.99-04.02	103,3					0 204 125 772		
									05.02-05.05	103,3	
Ducato Cargo											
	2.5 D	ABO	11.97-05.05	62			JBH	F 026 003 313	25,4		
								ABS	11.97-05.05	62	
	2.8 D Turbo	ABO	04.99-04.02	90				JBH	F 026 003 313	25,4	
									01.04-05.05	90	
		ABS	04.99-04.02	90						F 026 003 315	25,4
										05.02-05.05	90
	2.8 JTD	ABO	06.05-08.09	93					0 204 123 616	25,4	
									ABS	06.05-08.09	93

									
	2.8 D Turbo	11.00-04.02	90				0 204 125 772		
		05.02-05.05	90				0 204 125 801		
		06.05-08.09	93				0 204 125 801		
Ducato Minibus									
									
	2.8 JTD	ABO 06.05-08.09	93				0 204 123 616	25,4	
		ABS 06.05-08.09	93				0 204 123 615	25,4	
	2.8 JTD	06.05-08.09	93				0 204 125 801		
Ducato 10 [230]									
									
	1.9 D	ABO 04.98-10.01	50	Fg.-Nr. 5687088→5984271	RLE		0 204 122 270	23,81	
				Fg.-Nr. 5984272→	JBH,LLE		F 026 003 313	25,4	
		09.00-10.01	50	Fg.-Nr. 5984272→	RLE		0 204 123 325	23,8	
		ABS 04.98-10.01	50				F 026 003 315	25,4	
1.9 D	ABO 03.94-03.98	51/59/60	Fg.-Nr. →5064996	JBH,LLE		F 026 003 318	22,2		
1.9 TD				RLE		0 204 123 319	22,2		
1.9 TD CAT			Fg.-Nr. 5064997→	RLE		0 204 122 270	23,81		
	ABS 03.94-03.98	51/59/60	Fg.-Nr. →5064996			0 204 123 320	22,2		
			Fg.-Nr. 5064997→			F 026 003 315	25,4		
1.9 TD	ABO 04.98-10.01	66	Fg.-Nr. 5687088→5984271	RLE		0 204 122 270	23,81		
			Fg.-Nr. 5984272→	JBH,LLE		F 026 003 313	25,4		
		09.00-10.01	66	Fg.-Nr. 5984272→	RLE		0 204 123 325	23,8	
	ABS 04.98-10.01	66				F 026 003 315	25,4		
2.0	ABO 03.94-08.00	79/80	Fg.-Nr. 5687088→5984271	RLE		0 204 123 325	23,8		
2.0 i.e.	03.94-03.02	79/80	Fg.-Nr. →5064996	JBH,LLE		F 026 003 318	22,2		
2.0 i.e. Bipower CNG 4x4				RLE		0 204 123 319	22,2		
			Fg.-Nr. 5064997→5687087	RLE		0 204 122 270	23,81		
			Fg.-Nr. 5984272→6194400	JBH,LLE		F 026 003 313	25,4		
			Fg.-Nr. 6194401→			0 204 123 616	25,4		
	ABS 03.94-03.02	79/80	Fg.-Nr. →5064996			0 204 123 320	22,2		
			Fg.-Nr. 5064997→6194400			F 026 003 315	25,4		
			Fg.-Nr. 6194401→			0 204 123 615	25,4		
2.0 JTD	ABO 10.01-03.02	63	Fg.-Nr. →6194400	JBH,LLE		F 026 003 313	25,4		
			Fg.-Nr. 6194401→			0 204 123 616	25,4		
	ABS 10.01-03.02	63	Fg.-Nr. →6194400			F 026 003 315	25,4		
			Fg.-Nr. 6194401→			0 204 123 615	25,4		
2.5 D	ABO 03.94-03.98	62/80	Fg.-Nr. →5064996	JBH,LLE		F 026 003 318	22,2		
2.5 TD ECO				RLE		0 204 123 319	22,2		
			Fg.-Nr. 5064997→	RLE		0 204 122 270	23,81		
	ABS 03.94-03.98	62/80	Fg.-Nr. →5064996			0 204 123 320	22,2		
			Fg.-Nr. 5064997→			F 026 003 315	25,4		
2.5 TD EGR	ABO 03.94-03.98	85	Fg.-Nr. 5064997→	RLE		0 204 122 270	23,81		
2.5 TD EGR 4x4	ABS 03.94-03.98	85	Fg.-Nr. 5064997→			F 026 003 315	25,4		
2.5 TD EGR	ABO 03.94-03.98	85	Fg.-Nr. →5064996	JBH,LLE		F 026 003 318	22,2		
2.5 TD EGR 4x4				RLE		0 204 123 319	22,2		
2.5 TD 4x4	ABS 03.94-03.98	85	Fg.-Nr. →5064996			0 204 123 320	22,2		
2.5 TD 4x4	ABO 03.94-03.98	85	Fg.-Nr. 5064997→5687087	RLE		0 204 122 270	23,81		
	ABS 03.94-03.98	85	Fg.-Nr. 5064997→5687087			F 026 003 315	25,4		
2.8 D	ABO 04.98-08.00	64	Fg.-Nr. 5687088→5984271	RLE		0 204 123 325	23,8		
			Fg.-Nr. 5064997→5687087	RLE		0 204 122 270	23,81		
				Fg.-Nr. 5984272→6194400	JBH,LLE		F 026 003 313	25,4	
				Fg.-Nr. 6194401→			0 204 123 616	25,4	
	ABS 04.98-03.02	64	Fg.-Nr. →6194400			F 026 003 315	25,4		
			Fg.-Nr. 6194401→			0 204 123 615	25,4		
2.8 JTD EGR 4x4, JTD 4x4	ABO 08.00-03.02	94	Fg.-Nr. 5984272→6194400	JBH,LLE		F 026 003 313	25,4		
2.8 JTD, JTD EGR	ABO 09.00-11.01	94	Fg.-Nr. 5984272→6194400	JBH,LLE		F 026 003 313	25,4		





FIAT Ducato 10 [230]								
2.8 JTD, JTD EGR, JTD EGR 4x4, JTD 4x4	ABO	08.00-03.02	94	Fg.-Nr. 6194401→		0 204 123 616	25,4	
	ABS	08.00-03.02	94	Fg.-Nr. →6194400		F 026 003 315	25,4	
2.8 TD				Fg.-Nr. 6194401→		0 204 123 615	25,4	
	ABO	10.97-03.02	90	Fg.-Nr. →5064996	JBH,LLE	F 026 003 318	22,2	
					RLE	0 204 123 319	22,2	
				Fg.-Nr. 5064997→5687087	RLE	0 204 122 270	23,81	
				Fg.-Nr. 5984272→	JBH,LLE	F 026 003 313	25,4	
2.8 TD EGR				Fg.-Nr. 6194401→	JBH,RLE	F 026 003 313	25,4	
	ABS	10.97-03.02	90	Fg.-Nr. →5064996		0 204 123 320	22,2	
2.8 TD EGR 4x4	ABO	10.97-03.02	90	Fg.-Nr. 5064997→5687087	RLE	0 204 122 270	23,81	
2.8 TD 4x4		09.00-11.01	90	Fg.-Nr. 6194401→		0 204 123 616	25,4	
	ABS	10.97-03.02	90	Fg.-Nr. 5984272→6194400	JBH,LLE	F 026 003 313	25,4	
2.8 TD EGR 4x4, TD 4x4	ABS	10.97-03.02	90	Fg.-Nr. 6194401→		0 204 123 615	25,4	
2.8 TD, TD EGR	ABS	10.97-03.02	90	Fg.-Nr. 5064997→		F 026 003 315	25,4	
2.8 TD, TD EGR, TD EGR 4x4, TD 4x4	ABO	10.97-08.00	90	Fg.-Nr. 5687088→5984271	RLE	0 204 123 325	23,8	
1.9 D		04.98-08.00	50	Fg.-Nr. 5687088→5984271	LLE	0 204 125 746		
		09.00-10.01	50	Fg.-Nr. 5984272→	LLE	0 204 125 772		
					RLE	0 204 125 773		
1.9 D, TD, TD CAT	ABS	04.98-08.00	50	Fg.-Nr. 5687088→5984271		0 204 125 746		
		09.00-10.01	50	Fg.-Nr. 5984272→		0 204 125 772		
1.9 D, TD, TD CAT		03.94-03.98	51/59/60	Fg.-Nr. →5064996		0 204 125 445		
1.9 TD	ABO	04.98-08.00	66	Fg.-Nr. 5687088→5984271	LLE	0 204 125 746		
		09.00-10.01	66	Fg.-Nr. 5984272→	LLE	0 204 125 772		
					RLE	0 204 125 773		
2.0	ABS	04.98-08.00	66	Fg.-Nr. 5687088→5984271		0 204 125 746		
		09.00-10.01	66	Fg.-Nr. 5984272→		0 204 125 772		
2.0 i.e.		03.94-08.00	79/80	Fg.-Nr. 5687088→5984271		0 204 125 746		
2.0 i.e. Bipower CNG 4x4		03.94-03.02	79/80	Fg.-Nr. →5064996		0 204 125 445		
				Fg.-Nr. 5984272→6194400		0 204 125 772		
2.0, i.e., i.e. Bipower CNG 4x4, JTD				Fg.-Nr. 6194401→		0 204 125 801		
	ABO	12.01-03.02	63/79/80	Fg.-Nr. 6194401→		0 204 024 593 ^S		
2.0 JTD	ABS	03.94-03.02	63/79/80	Fg.-Nr. 6194401→		0 204 024 592 ^S		
		10.01-03.02	63	Fg.-Nr. →6194400		0 204 125 772		
2.5 D, TD ECO, TD EGR, TD EGR 4x4, TD 4x4				Fg.-Nr. 6194401→		0 204 125 801		
		03.94-03.98	62/80/85	Fg.-Nr. →5064996		0 204 125 445		
2.8 D		04.98-08.00	64	Fg.-Nr. 5687088→5984271		0 204 125 746		
		04.98-03.02	64	Fg.-Nr. 5984272→6194400		0 204 125 772		
				Fg.-Nr. 6194401→		0 204 125 801		
2.8 JTD EGR 4x4, JTD 4x4		08.00-03.02	94	Fg.-Nr. 5984272→6194400		0 204 125 772		
2.8 JTD, JTD EGR		08.00-03.02	94	Fg.-Nr. →6194400		0 204 125 772		
2.8 JTD, JTD EGR, JTD EGR 4x4, JTD 4x4		08.00-03.02	94	Fg.-Nr. 6194401→		0 204 125 801		
	ABO	12.01-03.02	94	Fg.-Nr. 6194401→		0 204 024 593 ^S		
2.8 TD	ABS	08.00-03.02	94	Fg.-Nr. 6194401→		0 204 024 592 ^S		
		10.97-08.00	90	Fg.-Nr. 5687088→5984271		0 204 125 746		
2.8 TD EGR, TD EGR 4x4, TD 4x4		10.97-03.02	90	Fg.-Nr. →5064996		0 204 125 445		
		10.97-08.00	90	Fg.-Nr. 5687088→5984271		0 204 125 746		
2.8 TD, TD EGR, TD EGR 4x4, TD 4x4		10.97-03.02	90	Fg.-Nr. 5984272→		0 204 125 772		
1.9 D	ABO	04.98-10.01	50		KOB	0 204 131 232 ^A		
	ABO	03.94-10.01	51/59/60/		LAB,WIF	0 204 031 056 ^A		
1.9 TD			66		RAB	0 204 131 232 ^A		
1.9 TD CAT	ABS	03.94-07.97	51/59/60	Fg.-Nr. →5445358		0 204 031 050 ^A		
2.0	ABO	03.94-03.02	79			0 204 131 232 ^A		
2.0 i.e., i.e. Bipower CNG 4x4	ABS	03.94-07.97	79/80	Fg.-Nr. →5445358		0 204 031 050 ^A		
2.0 i.e.	ABO	03.94-03.02	80			0 204 131 232 ^A		
2.0 i.e. Bipower CNG 4x4	ABO	03.94-03.02	80		KOB	0 204 131 232 ^A		
2.0 JTD	ABO	10.01-03.02	63	Fg.-Nr. 5048611→		0 204 131 232 ^A		
2.5 D, TD ECO	ABO	03.94-03.98	62/80		KOB	0 204 131 232 ^A		
2.5 D, TD ECO, TD EGR, TD EGR 4x4, TD 4x4	ABS	03.94-07.97	62/80/85	Fg.-Nr. →5445358		0 204 031 050 ^A		

		S							
2.5 TD EGR	ABO	03.94-03.98	85				0 204 131 232 ^A		
2.8 D	ABO	04.98-03.02	64			KOB	0 204 131 232 ^A		
2.8 JTD, JTD EGR, JTD EGR 4x4, JTD 4x4	ABO	08.00-03.02	94				0 204 131 232 ^A		
2.8 TD		10.97-03.02	90				0 204 131 232 ^A		
2.8 TD EGR	ABO	10.97-03.02	90				0 204 131 232 ^A		
2.8 TD EGR 4x4, TD 4x4	ABO	10.97-03.02	90			RAB	0 204 131 232 ^A		
2.8 TD, TD EGR 4x4, TD 4x4	ABO	10.97-03.02	90			LAB,WIF	0 204 031 056 ^A		
1.9 D, TD, TD CAT		08.97-10.01	50/51/59/60/66	Fg.-Nr. 5445359→6194400	L06,L07	BO	0 265 216 436 ^B		
2.0, i.e., i.e. Bipower CNG 4x4, JTD		08.97-11.01	63/79/80	Fg.-Nr. 5445359→6194400	L06,L07	BO	0 265 216 436 ^B		
		12.01-03.02	63/79/80	Fg.-Nr. 6194401→		BO	0 265 216 709 ^B		
2.5 D, TD ECO, TD EGR, TD EGR 4x4, TD 4x4		08.97-03.98	62/80/85	Fg.-Nr. 5445359→6194400	L06,L07	BO	0 265 216 436 ^B		
2.8 D, JTD, JTD EGR, JTD EGR 4x4, JTD 4x4, TD, TD EGR, TD EGR 4x4, TD 4x4		10.97-11.01	64/90/94	Fg.-Nr. 5445359→6194400	L06,L07	BO	0 265 216 436 ^B		
		12.01-03.02	64/90/94	Fg.-Nr. 6194401→		BO	0 265 216 709 ^B		
1.9 D, TD, TD CAT		08.97-10.01	50/51/59/60/66	Fg.-Nr. 5445359→6194400	L06,L07	BO	1 273 004 168 ^H		
2.0, i.e., i.e. Bipower CNG 4x4, JTD		08.97-11.01	63/79/80	Fg.-Nr. 5445359→6194400	L06,L07	BO	1 273 004 168 ^H		
2.5 D, TD ECO, TD EGR, TD EGR 4x4, TD 4x4		08.97-03.98	62/80/85	Fg.-Nr. 5445359→6194400	L06,L07	BO	1 273 004 168 ^H		
2.8 D, JTD, JTD EGR, JTD EGR 4x4, JTD 4x4, TD, TD EGR, TD EGR 4x4, TD 4x4		10.97-11.01	64/90/94	Fg.-Nr. 5445359→6194400	L06,L07	BO	1 273 004 168 ^H		
Ducato 10 [290]									
1.9 D		07.90-02.94	52/60			JBH,RLE	F 026 003 150	22,2	
1.9 TD				Fg.-Nr. →0273004, →0169505		JBH,LLE BSY	F 026 003 150	22,2	
				Fg.-Nr. 0273005→, 0169506→		JBH,LLE BSY	F 026 003 194	22,2	
2.0		07.90-02.94	55	Fg.-Nr. →0273004, →0169505		JBH,LLE BSY	F 026 003 150	22,2	
				Fg.-Nr. 0273005→, 0169506→		JBH,LLE BSY	F 026 003 194	22,2	
			63			JBH,RLE	F 026 003 150	22,2	
				Fg.-Nr. →0273004, →0169505		JBH,LLE BSY	F 026 003 150	22,2	
				Fg.-Nr. 0273005→, 0169506→		JBH,LLE BSY	F 026 003 194	22,2	
2.5 TD		07.90-02.94	70			JBH,RLE	F 026 003 150	22,2	
				Fg.-Nr. →0273004, →0169505		JBH,LLE BSY	F 026 003 150	22,2	
				Fg.-Nr. 0273005→, 0169506→		JBH,LLE BSY	F 026 003 194	22,2	
1.9 D		07.90-02.94	52/60			RLE	0 204 125 416 ^S		
1.9 TD							0 204 125 417		
				Fg.-Nr. →0169505		LLE	0 204 125 417		
				Fg.-Nr. →0273004, →0169505		LLE	0 204 125 416 ^S		
				Fg.-Nr. 0169506→		LLE	0 204 125 423		
				Fg.-Nr. 0273005→, 0169506→		LLE	0 204 125 420 ^S		
2.0		07.90-02.94	55/63			RLE	0 204 125 416 ^S		
							0 204 125 417		
				Fg.-Nr. →0169505		LLE	0 204 125 417		



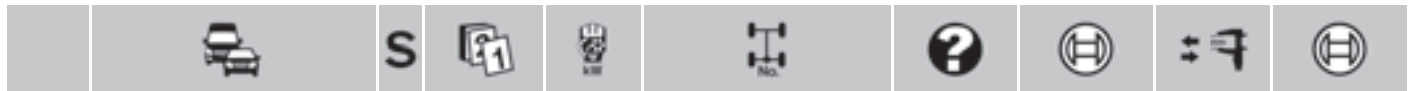















FIAT Ducato 10 [290]									
2.0	07.90-02.94	55/63	Fg.-Nr. →0273004, →0169505	LLE	BSY	0 204 125 416 ^S			
			Fg.-Nr. 0169506→ Fg.-Nr. 0273005→, 0169506→	LLE	BSY	0 204 125 423 0 204 125 420 ^S			
2.5 TD	07.90-02.94	70		RLE	BSY	0 204 125 416 ^S			
						0 204 125 417			
			Fg.-Nr. →0169505	LLE	BSY	0 204 125 417			
			Fg.-Nr. →0273004, →0169505	LLE	BSY	0 204 125 416 ^S			
			Fg.-Nr. 0169506→ Fg.-Nr. 0273005→, 0169506→	LLE	BSY	0 204 125 423 0 204 125 420 ^S			

Ducato 11 [244]

2.0 i.e., i.e. 4x4, JTD	ABO	04.02-08.06	62/81			0 204 123 616	25,4		
	ABS	04.02-08.06	62/81			0 204 123 615	25,4		
2.3 JTD	ABO	04.02-08.06	81			0 204 123 616	25,4		
		01.08-12.11	81			0 204 123 616	25,4		
	ABS	04.02-08.06	81			0 204 123 615	25,4		
		01.08-12.11	81			0 204 123 615	25,4		
2.3 JTD EGR	ABO	04.02-08.06	81			0 204 123 616	25,4		
	ABS	04.02-08.06	81			0 204 123 615	25,4		
2.8 JTD	ABO	04.02-08.06	94			0 204 123 616	25,4		
	ABS	04.02-08.06	94			0 204 123 615	25,4		
2.8 JTD EGR	ABO,	04.02-08.06	94		AG	0 204 123 615	25,4		
	ABS								
	ABS	04.02-08.06	94			0 204 123 615	25,4		
2.8 JTD EGR, JTD EGR 4x4	ABO	04.02-08.06	94		GS	0 204 123 616	25,4		
2.8 JTD EGR 4x4	ABO,	04.02-08.06	94		AG	0 204 123 615	25,4		
	ABS								
	ABS	04.02-08.06	94			0 204 123 615	25,4		
2.8 JTD 4x4	ABO	04.02-08.06	94			0 204 123 616	25,4		
	ABS	04.02-08.06	94			0 204 123 615	25,4		
2.8 TD, TD EGR, TD EGR 4x4	ABO	10.02-08.06	90			0 204 123 616	25,4		
	ABS	10.02-08.06	90			0 204 123 615	25,4		

2.0 i.e.		04.02-08.06	62/81			0 204 125 801			
	ABO	04.02-08.06	62/81			0 204 024 593 ^S			
2.0 JTD	ABS	04.02-08.06	62/81			0 204 024 592 ^S			
2.3 JTD		04.02-08.06	81			0 204 125 801			
		01.08-12.11	81			0 204 125 801			
2.3 JTD EGR		04.02-08.06	81			0 204 125 801			
2.3 JTD	ABO	04.02-08.06	81			0 204 024 593 ^S			
2.3 JTD EGR	ABS	04.02-08.06	81			0 204 024 592 ^S			
2.8 JTD		04.02-08.06	94			0 204 125 801			
	ABO	04.02-08.06	94			0 204 024 593 ^S			
	ABS	04.02-08.06	94			0 204 024 592 ^S			
2.8 JTD EGR		04.02-08.06	94		BUS,FKR	0 204 125 849			
					BUS,KLR	0 204 125 801			
2.8 JTD EGR, JTD EGR 4x4, JTD 4x4	ABO	04.02-08.06	94		GS	0 204 024 593 ^S			
	ABS	04.02-08.06	94		GS	0 204 024 592 ^S			
2.8 JTD EGR 4x4, JTD 4x4		04.02-08.06	94			0 204 125 801			
2.8 TD		10.02-08.06	90			0 204 125 801			
2.8 TD EGR	ABO	10.02-08.06	90			0 204 024 593 ^S			
2.8 TD EGR 4x4	ABS	10.02-08.06	90			0 204 024 592 ^S			

2.0 i.e.	ABO	04.02-08.06	81			0 204 031 182 ^A			
	ABO	04.02-08.06	81		KOB,KW	0 204 131 232 ^A			
	ABS	04.02-08.06	81			0 204 031 050 ^A			

								
2.0 JTD	ABO	04.02-08.06	62			0 204 031 182 ^A		
2.3 JTD		01.08-12.11	81			0 204 031 182 ^A		
	ABO	04.02-08.06	81			0 204 031 182 ^A		
2.3 JTD EGR	ABO	04.02-08.06	81			0 204 031 182 ^A		
2.8 JTD EGR 4x4	ABO	04.02-08.06	94		KOB, KW	0 204 131 232 ^A		
					RAB, WIF	0 204 131 232 ^A		
2.8 JTD EGR 4x4, JTD 4x4	ABO	04.02-08.06	94		LAB, WIF	0 204 031 056 ^A		
2.8 JTD EGR 4x4, JTD 4x4, TD EGR 4x4	ABS	04.02-08.06	90/94			0 204 031 050 ^A		
2.8 JTD, JTD EGR	ABO	04.02-08.06	94			0 204 031 182 ^A		
2.8 JTD 4x4		04.02-08.06	94			0 204 131 232 ^A		
2.8 TD EGR 4x4	ABO	10.02-08.06	90		KOB, KW	0 204 131 232 ^A		
					LAB, WIF	0 204 031 056 ^A		
					RAB, WIF	0 204 131 232 ^A		
2.8 TD, TD EGR	ABO	10.02-08.06	90			0 204 031 182 ^A		
 2.0 i.e.		04.02-08.06	81			0 265 216 709 ^B		
2.0 i.e. 4x4		04.02-08.06	81			0 265 216 707 ^B		
2.0 JTD		04.02-08.06	62			0 265 216 709 ^B		
2.3 JTD		01.08-12.11	81			0 265 232 115 ^B		
2.3 JTD, JTD EGR		04.02-08.06	81			0 265 216 709 ^B		
2.8 JTD EGR 4x4, JTD 4x4, TD EGR 4x4		04.02-08.06	90/94			0 265 216 707 ^B		
2.8 JTD, JTD EGR, TD, TD EGR		04.02-08.06	90/94			0 265 216 709 ^B		
Ducato 11 [250]								
								
 100 Multijet	MFD	06.06-12.14	74		G12, GS	0 204 123 719	25,4	
					G12, HAG	0 204 123 723	25,4	
	OFD	06.06-12.14	74		G10, GS	0 204 123 718	25,4	
					G10, HAG	0 204 123 722	25,4	
120 Multijet	MFD	06.06-12.14	88		G12, GS	0 204 123 719	25,4	
					G12, HAG	0 204 123 723	25,4	
	OFD	06.06-12.14	88		G10, GS	0 204 123 718	25,4	
					G10, HAG	0 204 123 722	25,4	
130 Multijet	MFD	06.06-12.14	96		G12, GS	0 204 123 719	25,4	
					G12, HAG	0 204 123 723	25,4	
	OFD	06.06-12.14	96		G10, GS	0 204 123 718	25,4	
					G10, HAG	0 204 123 722	25,4	
160 Multijet	MFD	06.06-12.14	116		G12, GS	0 204 123 719	25,4	
					G12, HAG	0 204 123 723	25,4	
	OFD	06.06-12.14	116		G10, GS	0 204 123 718	25,4	
					G10, HAG	0 204 123 722	25,4	
 100 Multijet		06.06-12.14	74		BSS	0 204 125 858		
					BSS	0 204 125 859		
120 Multijet		06.06-12.14	88		BSS	0 204 125 858		
					BSS	0 204 125 859		
130 Multijet		06.06-12.14	96		BSS	0 204 125 858		
					BSS	0 204 125 859		
160 Multijet		06.06-12.14	116		BSS	0 204 125 858		
					BSS	0 204 125 859		
 100 Multijet		06.06-03.08	74	Fg.-Nr. →1424797		0 265 233 330 ^F		
					GS, NAA	0 265 231 618 ^B		
					TW	0 265 234 069 ^T		
		06.06-12.14	74		HAG	0 265 232 113 ^B		
					TW	0 265 230 807 ^T		
		04.08-12.14	74	Fg.-Nr. 1424798 →		0 265 233 362 ^F		
					GS, NAA	0 265 232 113 ^B		
					TW	0 265 230 002 ^T		











		S							
FIAT Ducato 11 [250]									
120 Multijet	06.06-03.08	88	Fg.-Nr. →1424797				0 265 233 330 ^F		
				GS,NAA		0 265 231 618 ^B			
				TW		0 265 234 069 ^T			
	06.06-12.14	88		HAG		0 265 232 113 ^B			
				TW		0 265 230 807 ^T			
	04.08-12.14	88	Fg.-Nr. 1424798→				0 265 233 362 ^F		
GS,NAA					0 265 232 113 ^B				
TW					0 265 230 002 ^T				
130 Multijet	06.06-03.08	96	Fg.-Nr. →1424797				0 265 233 330 ^F		
				GS,NAA		0 265 231 618 ^B			
				TW		0 265 234 069 ^T			
	06.06-12.14	96		HAG		0 265 232 113 ^B			
				TW		0 265 230 807 ^T			
	04.08-12.14	96	Fg.-Nr. 1424798→				0 265 233 362 ^F		
GS,NAA					0 265 232 113 ^B				
TW					0 265 230 002 ^T				
160 Multijet	06.06-03.08	116	Fg.-Nr. →1424797				0 265 233 330 ^F		
				GS,NAA		0 265 231 618 ^B			
				TW		0 265 234 069 ^T			
	06.06-12.14	116		HAG		0 265 232 113 ^B			
				TW		0 265 230 807 ^T			
	04.08-12.14	116	Fg.-Nr. 1424798→				0 265 233 362 ^F		
GS,NAA					0 265 232 113 ^B				
TW					0 265 230 002 ^T				

Ducato 12 [290]

	2.0 4x4	07.90-02.94	63		JBH,RLE		F 026 003 150	22,2	
				Fg.-Nr. →0273004, →0169505	JBH,LLE	BSY	F 026 003 150	22,2	
				Fg.-Nr. 0273005→, 0169506→	JBH,LLE	BSY	F 026 003 194	22,2	
					JBH		F 026 003 150	22,2	
	2.0 4x4	07.90-02.94	63		RLE	BSY	0 204 125 416 ^S		
				Fg.-Nr. →0169505	LLE	BSY	0 204 125 417		
				Fg.-Nr. →0273004, →0169505	LLE	BSY	0 204 125 416 ^S		
				Fg.-Nr. 0169506→	LLE	BSY	0 204 125 423		
2.5 D 4x4	07.90-02.94	55			LLE	BSY	0 204 125 420 ^S		
				Fg.-Nr. →0169505	LLE	BSY	0 204 125 417		
				Fg.-Nr. →0273004, →0169505	LLE	BSY	0 204 125 416 ^S		
				Fg.-Nr. 0169506→	LLE	BSY	0 204 125 423		
2.5 TD 4x4	07.90-02.94	70			LLE		0 204 125 550 ^S		
					LLE	BSY	0 204 125 416 ^S		
				Fg.-Nr. →0169505	LLE	BSY	0 204 125 417		
				Fg.-Nr. →0273004, →0169505	LLE	BSY	0 204 125 416 ^S		
	LLE	BSY	0 204 125 423						
	LLE	BSY	0 204 125 420 ^S						

Ducato 14 [230]

	1.9 TD	ABO	04.98-10.01	66	Fg.-Nr. 5687088→	RLE		0 204 123 325	23,8	
					Fg.-Nr. 5984272→	JBH,LLE		F 026 003 313	25,4	
		ABS	04.98-10.01	66					F 026 003 315	25,4
		1.9 TD, TD CAT	ABO	03.94-03.98	59/60	Fg.-Nr. →5064996	JBH,LLE		F 026 003 318	22,2
RLE							0 204 123 319	22,2		
				Fg.-Nr. 5064997→	RLE		0 204 122 270	23,81		
ABS	03.94-03.98		59/60	Fg.-Nr. →5064996			0 204 123 320	22,2		
			Fg.-Nr. 5064997→			F 026 003 315	25,4			

		S							
2.0	ABO	03.94-08.00	79/80	Fg.-Nr. 5687088→5984271	RLE		0 204 123 325	23,8	
2.0 i.e.		03.94-03.02	79/80	Fg.-Nr. →5064996	JBH ,LLE		F 026 003 318	22,2	
2.0 i.e. Bipower CNG 4x4					RLE		0 204 123 319	22,2	
				Fg.-Nr. 5064997→5687087	RLE		0 204 122 270	23,81	
				Fg.-Nr. 5984272→6194400	JBH ,LLE		F 026 003 313	25,4	
				Fg.-Nr. 6194401→			0 204 123 616	25,4	
	ABS	03.94-03.02	79/80	Fg.-Nr. →5064996			0 204 123 320	22,2	
				Fg.-Nr. 5064997→6194400			F 026 003 315	25,4	
				Fg.-Nr. 6194401→			0 204 123 615	25,4	
2.0 JTD	ABO	10.01-03.02	63	Fg.-Nr. →6194400	JBH ,LLE		F 026 003 313	25,4	
				Fg.-Nr. 6194401→			0 204 123 616	25,4	
	ABS	10.01-03.02	63	Fg.-Nr. →6194400			F 026 003 315	25,4	
				Fg.-Nr. 6194401→			0 204 123 615	25,4	
2.5 D, TD, TD ECO, TD ECO 4x4, TD EGR, TD EGR 4x4	ABO	03.94-03.02	62/80/85	Fg.-Nr. →5064996	JBH ,LLE		F 026 003 318	22,2	
					RLE		0 204 123 319	22,2	
				Fg.-Nr. 5064997→	RLE		0 204 122 270	23,81	
	ABS	03.94-03.02	62/80/85	Fg.-Nr. →5064996			0 204 123 320	22,2	
				Fg.-Nr. 5064997→			F 026 003 315	25,4	
2.8 D	ABO	04.98-08.00	64	Fg.-Nr. 5687088→5984271	RLE		0 204 123 325	23,8	
		04.98-03.02	64	Fg.-Nr. 5064997→5687087	RLE		0 204 122 270	23,81	
				Fg.-Nr. 5984272→6194400	JBH ,LLE		F 026 003 313	25,4	
				Fg.-Nr. 6194401→			0 204 123 616	25,4	
	ABS	04.98-03.02	64	Fg.-Nr. →6194400			F 026 003 315	25,4	
				Fg.-Nr. 6194401→			0 204 123 615	25,4	
2.8 JTD EGR 4x4	ABO	08.00-03.02	94	Fg.-Nr. 5984272→6194400	JBH ,LLE		F 026 003 313	25,4	
2.8 JTD 4x4	ABS	08.00-03.02	94	Fg.-Nr. 5984272→6194400			F 026 003 315	25,4	
2.8 JTD	ABO	09.00-11.01	94	Fg.-Nr. 5984272→6194400	JBH ,LLE		F 026 003 313	25,4	
2.8 JTD EGR	ABS	09.00-11.01	94	Fg.-Nr. 5984272→6194400	LLE		F 026 003 315	25,4	
2.8 JTD, JTD EGR, JTD EGR 4x4, JTD 4x4	ABO	08.00-03.02	94	Fg.-Nr. 6194401→			0 204 123 616	25,4	
	ABS	08.00-03.02	94	Fg.-Nr. 6194401→			0 204 123 615	25,4	
2.8 TD	ABO	10.97-08.00	90	Fg.-Nr. 5687088→5984271	RLE		0 204 123 325	23,8	
2.8 TD EGR		10.97-03.02	90	Fg.-Nr. 5064997→5687087	RLE		0 204 122 270	23,81	
2.8 TD EGR 4x4				Fg.-Nr. 5984272→6194400	JBH ,LLE		F 026 003 313	25,4	
2.8 TD 4x4				Fg.-Nr. 6194401→	JBH		F 026 003 313	25,4	
	ABS	10.97-03.02	90				F 026 003 315	25,4	
1.9 TD		04.98-08.00	66	Fg.-Nr. 5687088→5984271			0 204 125 746		
	ABO	09.00-10.01	66	Fg.-Nr. 5984272→	LLE		0 204 125 772		
					RLE		0 204 125 773		
	ABS	09.00-10.01	66	Fg.-Nr. 5984272→			0 204 125 772		
1.9 TD, TD CAT		03.94-03.98	59/60	Fg.-Nr. →5064996			0 204 125 445		
2.0		03.94-08.00	79/80	Fg.-Nr. 5687088→5984271			0 204 125 746		
2.0 i.e.		03.94-03.02	79/80	Fg.-Nr. →5064996			0 204 125 445		
2.0 i.e. Bipower CNG 4x4				Fg.-Nr. 5984272→6194400			0 204 125 772		
				Fg.-Nr. 6194401→			0 204 125 801		
2.0, i.e., i.e. Bipower CNG 4x4, JTD	ABO	12.01-03.02	63/79/80	Fg.-Nr. 6194401→			0 204 024 593^S		
	ABS	03.94-03.02	63/79/80	Fg.-Nr. 6194401→			0 204 024 592^S		
2.0 JTD		10.01-03.02	63	Fg.-Nr. →6194400			0 204 125 772		
				Fg.-Nr. 6194401→			0 204 125 801		
2.5 D, TD, TD ECO, TD ECO 4x4, TD EGR, TD EGR 4x4		03.94-03.02	62/80/85	Fg.-Nr. →5064996			0 204 125 445		
2.8 D		04.98-08.00	64	Fg.-Nr. 5687088→5984271			0 204 125 746		
		04.98-03.02	64	Fg.-Nr. 5984272→6194400			0 204 125 772		
				Fg.-Nr. 6194401→			0 204 125 801		
2.8 JTD EGR 4x4, JTD 4x4		08.00-03.02	94	Fg.-Nr. 5984272→6194400			0 204 125 772		
2.8 JTD, JTD EGR		08.00-03.02	94	Fg.-Nr. →6194400			0 204 125 772		
2.8 JTD, JTD EGR, JTD EGR 4x4, JTD 4x4		08.00-03.02	94	Fg.-Nr. 6194401→			0 204 125 801		
	ABO	12.01-03.02	94	Fg.-Nr. 6194401→			0 204 024 593^S		
	ABS	08.00-03.02	94	Fg.-Nr. 6194401→			0 204 024 592^S		
2.8 TD, TD EGR, TD EGR 4x4, TD 4x4		10.97-08.00	90	Fg.-Nr. 5687088→5984271			0 204 125 746		
		10.97-03.02	90	Fg.-Nr. 5984272→			0 204 125 772		



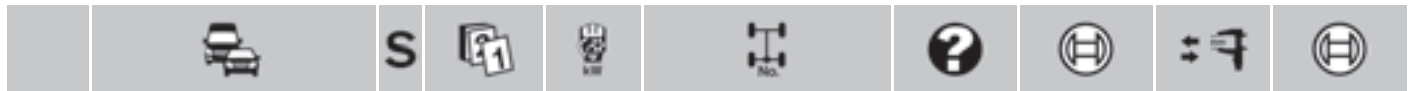

FIAT Ducato 14 [230]

	1.9 TD	ABO	03.94-10.01	59/60/66				LAB,WIF	0 204 031 056 ^A	
	1.9 TD CAT							RAB	0 204 131 232 ^A	
		ABS	03.94-07.97	59/60	Fg.-Nr. →5445358				0 204 031 050 ^A	
			03.94-03.98	59/60					0 204 131 217	
	2.0, i.e.	ABO	03.94-03.02	79/80					0 204 131 232 ^A	
	2.0, i.e., i.e. Bipower CNG 4x4	ABS	03.94-07.97	79/80	Fg.-Nr. →5445358				0 204 031 050 ^A	
	2.0 JTD	ABO	10.01-03.02	63	Fg.-Nr. 5048611→				0 204 131 232 ^A	
	2.5 D, TD ECO, TD ECO 4x4	ABS	03.94-07.97	62/80	Fg.-Nr. →5445358				0 204 031 050 ^A	
	2.5 D, TD, TD ECO, TD EGR	ABO	03.94-03.02	62/80/85				LAB,WIF	0 204 031 056 ^A	
								RAB	0 204 131 232 ^A	
	2.5 TD EGR	ABS	03.94-03.98	85					0 204 131 217	
	2.5 TD, TD EGR, TD EGR 4x4	ABS	03.94-07.97	85	Fg.-Nr. →5445358				0 204 031 050 ^A	
	2.8 D, JTD, JTD EGR, JTD EGR 4x4, JTD 4x4, TD, TD EGR	ABO	10.97-03.02	64/90/94				LAB,WIF	0 204 031 056 ^A	
								RAB	0 204 131 232 ^A	











	1.9 TD, TD CAT		08.97-10.01	59/60/66	Fg.-Nr. 5445359→6194400	L06,L07	BO		0 265 216 436 ^B	
	2.0, i.e., i.e. Bipower CNG 4x4, JTD		08.97-11.01	63/79/80	Fg.-Nr. 5445359→6194400	L06,L07	BO		0 265 216 436 ^B	
			12.01-03.02	63/79/80	Fg.-Nr. 6194401→		BO		0 265 216 709 ^B	
	2.5 D, TD ECO, TD ECO 4x4		08.97-03.98	62/80	Fg.-Nr. 5445359→6194400	L06,L07	BO		0 265 216 436 ^B	
	2.5 TD		12.01-03.02	85	Fg.-Nr. 6194401→		BO		0 265 216 709 ^B	
	2.5 TD, TD EGR, TD EGR 4x4		08.97-11.01	85	Fg.-Nr. 5445359→6194400	L06,L07	BO		0 265 216 436 ^B	
	2.8 D, JTD, JTD EGR, JTD EGR 4x4, JTD 4x4, TD, TD EGR, TD EGR 4x4, TD 4x4		10.97-11.01	64/90/94	Fg.-Nr. 5445359→6194400	L06,L07	BO		0 265 216 436 ^B	
			12.01-03.02	64/90/94	Fg.-Nr. 6194401→		BO		0 265 216 709 ^B	

	1.9 TD, TD CAT		08.97-10.01	59/60/66	Fg.-Nr. 5445359→6194400	L06,L07	BO		1 273 004 168 ^H	
	2.0, i.e., i.e. Bipower CNG 4x4, JTD		08.97-11.01	63/79/80	Fg.-Nr. 5445359→6194400	L06,L07	BO		1 273 004 168 ^H	
	2.5 D, TD, TD ECO, TD ECO 4x4, TD EGR, TD EGR 4x4		08.97-11.01	62/80/85	Fg.-Nr. 5445359→6194400	L06,L07	BO		1 273 004 168 ^H	
	2.8 D, JTD, JTD EGR, JTD EGR 4x4, JTD 4x4, TD, TD EGR, TD EGR 4x4, TD 4x4		10.97-11.01	64/90/94	Fg.-Nr. 5445359→6194400	L06,L07	BO		1 273 004 168 ^H	

Ducato 14 [290]

	1.9 TD		07.90-02.94	60				JBH,RLE	F 026 003 150	22,2
					Fg.-Nr. →0273004, →0169505			JBH,LLE	BSY F 026 003 150	22,2
					Fg.-Nr. 0273005→, 0169506→			JBH,LLE	BSY F 026 003 194	22,2
	2.0		07.90-02.94	55/63				JBH,RLE	F 026 003 150	22,2
					Fg.-Nr. →0273004, →0169505			JBH,LLE	BSY F 026 003 150	22,2
					Fg.-Nr. 0273005→, 0169506→			JBH,LLE	BSY F 026 003 194	22,2
	2.5 D		07.90-02.94	55/70				JBH,RLE	F 026 003 150	22,2
	2.5 TD				Fg.-Nr. →0273004, →0169505			JBH,LLE	BSY F 026 003 150	22,2
					Fg.-Nr. 0273005→, 0169506→			JBH,LLE	BSY F 026 003 194	22,2

	1.9 TD		07.90-02.94	60				RLE	BSY	0 204 125 416 ^S
					Fg.-Nr. →0169505			LLE	BSY	0 204 125 417
					Fg.-Nr. →0273004, →0169505			LLE	BSY	0 204 125 416 ^S
					Fg.-Nr. 0169506→			LLE	BSY	0 204 125 423
					Fg.-Nr. 0273005→, 0169506→			LLE	BSY	0 204 125 420 ^S
	2.0		07.90-02.94	55/63				RLE	BSY	0 204 125 416 ^S
					Fg.-Nr. →0169505			LLE	BSY	0 204 125 417
					Fg.-Nr. →0273004, →0169505			LLE	BSY	0 204 125 416 ^S

		S							
2.0		07.90-02.94	55/63	Fg.-Nr. 0169506→ Fg.-Nr. 0273005→, 0169506→	LLE	BSY	0 204 125 423 0 204 125 420^S		
2.5 D 2.5 TD		07.90-02.94	55/70		RLE	BSY	0 204 125 416^S 0 204 125 417		
				Fg.-Nr. →0169505	LLE	BSY	0 204 125 417		
				Fg.-Nr. →0273004, →0169505	LLE	BSY	0 204 125 416^S		
				Fg.-Nr. 0169506→	LLE	BSY	0 204 125 423		
				Fg.-Nr. 0273005→, 0169506→	LLE	BSY	0 204 125 420^S		
Ducato 15 [244]									
									
	2.0 i.e., i.e. Bipower CNG, i.e. Bipower CNG 4x4, i.e. Bipower LPG, i.e. Bipower LPG 4x4 i.e. 4x4, JTD	ABO	04.02-08.06	62/71-81			0 204 123 616	25,4	
		ABS	04.02-08.06	62/71-81			0 204 123 615	25,4	
	2.3 JTD	ABO	04.02-08.06	81			0 204 123 616	25,4	
			01.08-12.11	81			0 204 123 616	25,4	
		ABS	04.02-08.06	81			0 204 123 615	25,4	
			01.08-12.11	81			0 204 123 615	25,4	
	2.3 JTD EGR	ABO	04.02-08.06	81			0 204 123 616	25,4	
			01.08-12.11	81			0 204 123 616	25,4	
		ABS	04.02-08.06	81			0 204 123 615	25,4	
			01.08-12.11	81			0 204 123 615	25,4	
	2.8 JTD	ABO	04.02-08.06	94			0 204 123 616	25,4	
		ABS	04.02-08.06	94			0 204 123 615	25,4	
	2.8 JTD CGV	ABO	04.04-08.06	107			0 204 123 616	25,4	
		ABS	04.04-08.06	107			0 204 123 615	25,4	
	2.8 JTD EGR	ABO,	04.02-08.06	94		AG	0 204 123 615	25,4	
		ABS							
		ABS	04.02-08.06	94			0 204 123 615	25,4	
	2.8 JTD EGR, JTD EGR 4x4	ABO	04.02-08.06	94		GS	0 204 123 616	25,4	
	2.8 JTD EGR 4x4	ABO,	04.02-08.06	94		AG	0 204 123 615	25,4	
		ABS							
		ABS	04.02-08.06	94			0 204 123 615	25,4	
	2.8 JTD 4x4	ABO	04.02-08.06	94			0 204 123 616	25,4	
		ABS	04.02-08.06	94			0 204 123 615	25,4	
	2.8 TD, TD EGR, TD EGR 4x4, TD 4x4	ABO	10.02-08.06	90			0 204 123 616	25,4	
		ABS	10.02-08.06	90			0 204 123 615	25,4	
	2.0 i.e., i.e. Bipower CNG, i.e. Bipower CNG 4x4, i.e. Bipower LPG, i.e. Bipower LPG 4x4, i.e. 4x4, JTD		04.02-08.06	62/71-81			0 204 125 801		
		ABO	04.02-08.06	62/71-81			0 204 024 593^S		
		ABS	04.02-08.06	62/71-81			0 204 024 592^S		
	2.3 JTD		04.02-08.06	81			0 204 125 801		
			01.08-12.11	81			0 204 125 801		
	2.3 JTD EGR		04.02-08.06	81			0 204 125 801		
			01.08-12.11	81			0 204 125 801		
	2.3 JTD	ABO	04.02-08.06	81			0 204 024 593^S		
	2.3 JTD EGR	ABS	04.02-08.06	81			0 204 024 592^S		
	2.8 JTD, JTD CGV, JTD EGR, JTD EGR 4x4, JTD 4x4	ABO	04.02-08.06	94/107		GS	0 204 024 593^S		
		ABS	04.02-08.06	94/107		GS	0 204 024 592^S		
	2.8 JTD, JTD CGV, JTD EGR, JTD EGR 4x4, JTD 4x4, TD, TD EGR, TD EGR 4x4, TD 4x4		04.02-08.06	90/94/107			0 204 125 801		
	2.8 TD, TD EGR, TD EGR 4x4, TD 4x4	ABO	10.02-08.06	90			0 204 024 593^S		
		ABS	10.02-08.06	90			0 204 024 592^S		





FIAT Ducato 15 [244]

	2.0 i.e.	ABO	04.02-08.06	81	DOP,FGS	0 204 031 183 ^A	
					FEV	0 204 031 184 ^A	
					KOB,KW	0 204 031 182 ^A	
	2.0 i.e. Bipower CNG	ABO	04.02-08.06	71-81	DOP,FGS	0 204 031 183 ^A	
					FEV	0 204 031 184 ^A	
					KOB,KW	0 204 031 182 ^A	
	2.0 i.e. Bipower CNG 4x4		04.02-08.06	71-81	FEV	0 204 031 184 ^A	
					FLR	0 204 031 183 ^A	
		ABO	04.02-08.06	71-81	FKR	0 204 031 182 ^A	
	2.0 i.e. Bipower CNG 4x4	ABO	04.02-08.06	71-81	KOB,KW	0 204 131 232 ^A	
	2.0 i.e. Bipower LPG 4x4						
	2.0 i.e. Bipower CNG 4x4	ABS	04.02-08.06	71-81		0 204 031 050 ^A	
	2.0 i.e. Bipower LPG 4x4						
	2.0 i.e. 4x4						
	2.0 i.e. Bipower LPG	ABO	04.02-08.06	71-81	DOP,FGS	0 204 031 183 ^A	
					FEV	0 204 031 184 ^A	
					KOB,KW	0 204 031 182 ^A	
	2.0 i.e. Bipower LPG 4x4		04.02-08.06	71-81	FEV	0 204 031 184 ^A	
					FLR	0 204 031 183 ^A	
		ABO	04.02-08.06	71-81	FKR	0 204 031 182 ^A	
	2.0 i.e. 4x4	ABO	04.02-08.06	81	KOB,KW	0 204 131 232 ^A	
	2.0 JTD	ABO	04.02-08.06	62	DOP,FGS	0 204 031 183 ^A	
					FEV	0 204 031 184 ^A	
					KOB,KW	0 204 031 182 ^A	
	2.3 JTD		01.08-12.11	81		0 204 031 182 ^A	
		ABO	04.02-08.06	81	KOB,KW	0 204 031 182 ^A	
	2.3 JTD EGR		01.08-12.11	81		0 204 031 182 ^A	
		ABO	04.02-08.06	81	KOB,KW	0 204 031 182 ^A	
	2.3 JTD	ABO	04.02-08.06	81	DOP,FGS	0 204 031 183 ^A	
	2.3 JTD EGR				FEV	0 204 031 184 ^A	
	2.8 JTD CGV	ABO	04.04-08.06	107	DOP,FGS	0 204 031 183 ^A	
					FEV	0 204 031 184 ^A	
					KOB,KW	0 204 031 182 ^A	
	2.8 JTD EGR 4x4		04.02-08.06	94	FEV	0 204 031 184 ^A	
	2.8 JTD 4x4				FLR	0 204 031 183 ^A	
		ABO	04.02-08.06	94	FKR	0 204 031 182 ^A	
					KOB,KW	0 204 131 232 ^A	
					LAB,WIF	0 204 031 056 ^A	
					RAB,WIF	0 204 131 232 ^A	
	2.8 JTD EGR 4x4, JTD 4x4, TD EGR 4x4, TD 4x4	ABS	04.02-08.06	90/94		0 204 031 050 ^A	
	2.8 JTD	ABO	04.02-08.06	94	DOP,FGS	0 204 031 183 ^A	
	2.8 JTD EGR				FEV	0 204 031 184 ^A	
					KOB,KW	0 204 031 182 ^A	
	2.8 TD EGR 4x4	ABO	10.02-08.06	90	KOB,KW	0 204 131 232 ^A	
	2.8 TD 4x4				LAB,WIF	0 204 031 056 ^A	
					RAB,WIF	0 204 131 232 ^A	
	2.8 TD	ABO	10.02-08.06	90	DOP,FGS	0 204 031 183 ^A	
	2.8 TD EGR				FEV	0 204 031 184 ^A	
					KOB,KW	0 204 031 182 ^A	
	2.0 i.e. Bipower CNG 4x4		04.02-08.06	71-81		0 265 216 707 ^B	
	2.0 i.e. Bipower LPG 4x4						
	2.0 i.e. 4x4						
	2.0 i.e., i.e. Bipower CNG, i.e. Bipower LPG		04.02-08.06	71-81		0 265 216 709 ^B	
	2.0 JTD		04.02-08.06	62		0 265 216 709 ^B	
	2.3 JTD		04.02-08.06	81		0 265 216 709 ^B	
	2.3 JTD EGR		01.08-12.11	81		0 265 232 115 ^B	
	2.8 JTD CGV		04.04-08.06	107		0 265 216 709 ^B	
	2.8 JTD EGR 4x4, JTD 4x4, TD EGR 4x4, TD 4x4		04.02-08.06	90/94		0 265 216 707 ^B	
	2.8 JTD, JTD EGR, TD, TD EGR		04.02-08.06	90/94		0 265 216 709 ^B	



Ducato 15 [250]

Icon	Model	Code	Year	Notes	Part Code	Price	
	100 Multijet	MFD	06.06-12.14	74	G12,GS	0 204 123 719	
					G12,HAG	0 204 123 723	
		OFD	06.06-12.14	74	G10,GS	0 204 123 718	
					G10,HAG	0 204 123 722	
		120 Multijet	MFD	06.06-12.14	88	G12,GS	0 204 123 719
						G12,HAG	0 204 123 723
			OFD	06.06-12.14	88	G10,GS	0 204 123 718
					G10,HAG	0 204 123 722	
		130 Multijet	MFD	06.06-12.14	96	G12,GS	0 204 123 719
						G12,HAG	0 204 123 723
			OFD	06.06-12.14	96	G10,GS	0 204 123 718
					G10,HAG	0 204 123 722	
	160 Multijet	MFD	06.06-12.14	116	G12,GS	0 204 123 719	
					G12,HAG	0 204 123 723	
		OFD	06.06-12.14	116	G10,GS	0 204 123 718	
				G10,HAG	0 204 123 722		
	100 Multijet		06.06-12.14	74	BSS	0 204 125 858	
					BSS	0 204 125 859	
	120 Multijet		06.06-12.14	88	BSS	0 204 125 858	
					BSS	0 204 125 859	
	130 Multijet		06.06-12.14	96	BSS	0 204 125 858	
					BSS	0 204 125 859	
	100 Multijet		06.06-03.08	74	Fg.-Nr. →1424797	0 265 233 330 ^F	
						GS,NAA	0 265 231 618 ^B
						TW	0 265 234 069 ^T
			06.06-12.14	74		HAG	0 265 232 113 ^B
						TW	0 265 230 807 ^T
			04.08-12.14	74	Fg.-Nr. 1424798→		0 265 233 362 ^F
					GS,NAA	0 265 232 113 ^B	
					TW	0 265 230 002 ^T	
	120 Multijet		06.06-03.08	88	Fg.-Nr. →1424797		0 265 233 330 ^F
						GS,NAA	0 265 231 618 ^B
						TW	0 265 234 069 ^T
			06.06-12.14	88		HAG	0 265 232 113 ^B
				TW	0 265 230 807 ^T		
	04.08-12.14	88	Fg.-Nr. 1424798→		0 265 233 362 ^F		
				GS,NAA	0 265 232 113 ^B		
				TW	0 265 230 002 ^T		
130 Multijet		06.06-03.08	96	Fg.-Nr. →1424797		0 265 233 330 ^F	
					GS,NAA	0 265 231 618 ^B	
					TW	0 265 234 069 ^T	
		06.06-12.14	96		HAG	0 265 232 113 ^B	
				TW	0 265 230 807 ^T		
	04.08-12.14	96	Fg.-Nr. 1424798→		0 265 233 362 ^F		
				GS,NAA	0 265 232 113 ^B		
				TW	0 265 230 002 ^T		
160 Multijet		06.06-03.08	116	Fg.-Nr. →1424797		0 265 233 330 ^F	
					GS,NAA	0 265 231 618 ^B	
					TW	0 265 234 069 ^T	
		06.06-12.14	116		HAG	0 265 232 113 ^B	
				TW	0 265 230 807 ^T		
	04.08-12.14	116	Fg.-Nr. 1424798→		0 265 233 362 ^F		
				GS,NAA	0 265 232 113 ^B		
				TW	0 265 230 002 ^T		





FIAT

Ducato 17 [250]



	100 Multijet	MFD 06.06-12.14	74	G12,GS	0 204 123 721	26,9
		OFD 06.06-12.14	74	G12,HAG	0 204 123 725	26,9
	120 Multijet	MFD 06.06-12.14	88	G10,GS	0 204 123 720	26,9
		OFD 06.06-12.14	88	G10,HAG	0 204 123 724	26,9
	120 Multijet Maxi	MFD 06.06-12.14	88	G12,GS	0 204 123 721	26,9
		OFD 06.06-12.14	88	G12,HAG	0 204 123 725	26,9
	130 Multijet	MFD 06.06-12.14	96	G10,GS	0 204 123 720	26,9
		OFD 06.06-12.14	96	G10,HAG	0 204 123 724	26,9
	130 Multijet Maxi	MFD 06.06-12.14	96	G12,GS	0 204 123 721	26,9
		OFD 06.06-12.14	96	G12,HAG	0 204 123 725	26,9
	140 Natural Power	MFD 06.06-12.14	100	G10,GS	0 204 123 720	26,9
		OFD 06.06-12.14	100	G10,HAG	0 204 123 724	26,9
	150 Multijet	MFD 04.10-12.14	107	G12,GS	0 204 123 721	26,9
		OFD 04.10-12.14	107	G12,HAG	0 204 123 725	26,9
	160 Multijet	MFD 06.06-12.14	116	G10,GS	0 204 123 720	26,9
		OFD 06.06-12.14	116	G10,HAG	0 204 123 724	26,9

	100 Multijet	06.06-12.14	74	BSS	0 204 125 860	
				BSS	0 204 125 861	
	120 Multijet	06.06-12.14	88	BSS	0 204 125 860	
				BSS	0 204 125 861	
	130 Multijet	06.06-12.14	96	BSS	0 204 125 860	
				BSS	0 204 125 861	
	140 Natural Power	06.06-12.14	100	BSS	0 204 125 860	
				BSS	0 204 125 861	
	150 Multijet	04.10-12.14	107	BSS	0 204 125 860	
				BSS	0 204 125 861	
	160 Multijet	06.06-12.14	116	BSS	0 204 125 860	
				BSS	0 204 125 861	

	100 Multijet	06.06-03.08	74	Fg.-Nr. →1424797	GS,NAA	0 265 233 330 ^F
					TW	0 265 231 618 ^B
	120 Multijet	06.06-12.14	74	Fg.-Nr. →1424797	HAG	0 265 234 069 ^T
					TW	0 265 232 113 ^B
	120 Multijet Maxi	06.06-12.14	88	Fg.-Nr. →1424797	TW	0 265 230 807 ^T
					HAG	0 265 233 362 ^F
	130 Multijet, Multijet Maxi	04.08-12.14	96	Fg.-Nr. 1424798→	GS,NAA	0 265 232 113 ^B
					TW	0 265 230 002 ^T
	130 Multijet, Multijet Maxi	06.06-03.08	96	Fg.-Nr. →1424797	GS,NAA	0 265 233 330 ^F
					TW	0 265 231 618 ^B
	130 Multijet, Multijet Maxi	06.06-12.14	96	Fg.-Nr. →1424797	TW	0 265 234 069 ^T
					HAG	0 265 232 113 ^B
	130 Multijet, Multijet Maxi	06.06-12.14	96	Fg.-Nr. →1424797	TW	0 265 230 807 ^T
					HAG	0 265 233 362 ^F
	130 Multijet, Multijet Maxi	06.06-12.14	96	Fg.-Nr. →1424797	GS,NAA	0 265 232 113 ^B
					TW	0 265 230 002 ^T

		S							
130 Multijet, Multijet Maxi	04.08-12.14	96	Fg.-Nr. 1424798→				0 265 233 362 ^F		
				GS,NAA			0 265 232 113 ^B		
				TW			0 265 230 002 ^T		
140 Natural Power	06.06-03.08	100	Fg.-Nr. →1424797				0 265 231 618 ^B		
							0 265 233 330 ^F		
				TW			0 265 234 069 ^T		
	06.06-12.14	100		TW			0 265 230 807 ^T		
	04.08-12.14	100	Fg.-Nr. 1424798→				0 265 232 113 ^B		
							0 265 233 362 ^F		
				TW			0 265 230 002 ^T		
150 Multijet	04.10-12.14	107					0 265 233 362 ^F		
				NAA			0 265 232 113 ^B		
				TW			0 265 230 002 ^T		
							0 265 230 807 ^T		
160 Multijet	06.06-03.08	116	Fg.-Nr. →1424797				0 265 233 330 ^F		
160 Multijet Maxi				GS,NAA			0 265 231 618 ^B		
				TW			0 265 234 069 ^T		
	06.06-12.14	116		HAG			0 265 232 113 ^B		
				TW			0 265 230 807 ^T		
	04.08-12.14	116	Fg.-Nr. 1424798→				0 265 233 362 ^F		
				GS,NAA			0 265 232 113 ^B		
				TW			0 265 230 002 ^T		

Ducato 18 [230]

	2.0 i.e. Bipower CNG	ABO	03.94-03.02	80	Fg.-Nr. →5687087	RLE	0 204 123 314	25,4	
					Fg.-Nr. →6194400	JBH,LLE	F 026 003 313	25,4	
					Fg.-Nr. 6194401→		0 204 123 616	25,4	
		ABS	03.94-03.02	80	Fg.-Nr. →6194400		F 026 003 315	25,4	
					Fg.-Nr. 6194401→		0 204 123 615	25,4	
	2.5 D	ABO	03.94-03.98	62		RLE	0 204 123 314	25,4	
	2.5 D, D 4x4	ABO	03.94-03.98	62		JBH,LLE	F 026 003 313	25,4	
	2.5 D, D 4x4, TD, TD ECO, TD 4x4	ABS	03.94-03.02	62/80/85			F 026 003 315	25,4	
	2.5 D 4x4	ABO	03.94-03.98	62	Fg.-Nr. →5687087	RLE	0 204 123 314	25,4	
	2.5 TD	ABO	03.94-03.02	85		RLE	0 204 123 314	25,4	
	2.5 TD ECO	ABO	03.94-03.98	80		JBH,LLE	F 026 003 313	25,4	
						RLE	0 204 123 314	25,4	
	2.5 TD, TD 4x4	ABO	03.94-03.02	85		JBH,LLE	F 026 003 313	25,4	
	2.5 TD 4x4	ABO	03.94-03.02	85	Fg.-Nr. →5687087	RLE	0 204 123 314	25,4	
	2.8 D	ABO	04.98-03.02	64	Fg.-Nr. →5687087	RLE	0 204 123 314	25,4	
	2.8 D 4x4				Fg.-Nr. →6194400	JBH,LLE	F 026 003 313	25,4	
					Fg.-Nr. 6194401→		0 204 123 616	25,4	
		ABS	04.98-03.02	64	Fg.-Nr. 6194401→		0 204 123 615	25,4	
	2.8 D 4x4	ABS	04.98-03.02	64	Fg.-Nr. →6194400		F 026 003 315	25,4	
	2.8 JTD	ABO	08.00-03.02	94	Fg.-Nr. →6194400	JBH,LLE	F 026 003 313	25,4	
	2.8 JTD EGR				Fg.-Nr. 6194401→		0 204 123 616	25,4	
	2.8 JTD EGR 4x4	ABS	08.00-03.02	94	Fg.-Nr. →6194400		F 026 003 315	25,4	
	2.8 JTD 4x4				Fg.-Nr. 6194401→		0 204 123 615	25,4	
	2.8 TD	ABO	10.97-03.02	90	Fg.-Nr. →5687087	RLE	0 204 123 314	25,4	
	2.8 TD EGR				Fg.-Nr. →6194400	JBH,LLE	F 026 003 313	25,4	
	2.8 TD EGR 4x4				Fg.-Nr. 6194401→	JBH	F 026 003 313	25,4	
	2.8 TD 4x4	ABS	10.97-03.02	90			F 026 003 315	25,4	
	2.0 i.e. Bipower CNG		03.94-08.00	80	Fg.-Nr. 5687088→5984271		0 204 125 746		
			03.94-03.02	80	Fg.-Nr. 5984272→6194400		0 204 125 772		
					Fg.-Nr. 6194401→		0 204 125 801		
		ABO	12.01-03.02	80	Fg.-Nr. 6194401→		0 204 024 593 ^S		
		ABS	03.94-03.02	80	Fg.-Nr. 6194401→		0 204 024 592 ^S		
	2.5 D 4x4, TD 4x4		03.94-03.02	62/85	Fg.-Nr. 5687088→		0 204 125 746		
	2.8 D		04.98-08.00	64	Fg.-Nr. 5687088→5984271		0 204 125 746		
	2.8 D 4x4		04.98-03.02	64	Fg.-Nr. 5984272→6194400		0 204 125 772		
					Fg.-Nr. 6194401→		0 204 125 801		

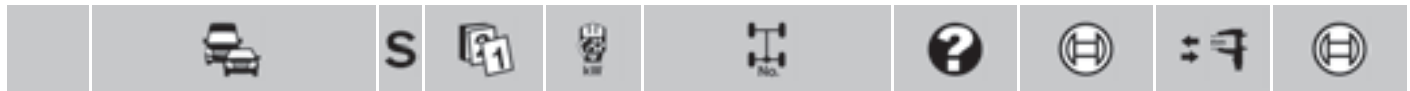

FIAT Ducato 18 [230]						
2.8 JTD EGR 4x4	08.00-03.02	94	Fg.-Nr. 5971211→5984271		0 204 125 746	
2.8 JTD 4x4			Fg.-Nr. 5984272→6194400		0 204 125 772	
2.8 JTD, JTD EGR	08.00-03.02	94	Fg.-Nr. →6194400		0 204 125 772	
2.8 JTD, JTD EGR, JTD EGR 4x4, JTD 4x4	08.00-03.02	94	Fg.-Nr. 6194401→		0 204 125 801	
	ABO 12.01-03.02	94	Fg.-Nr. 6194401→		0 204 024 593 ^S	
	ABS 08.00-03.02	94	Fg.-Nr. 6194401→		0 204 024 592 ^S	
2.8 TD, TD EGR, TD EGR 4x4, TD 4x4	10.97-08.00	90	Fg.-Nr. 5687088→5984271		0 204 125 746	
	10.97-03.02	90	Fg.-Nr. 5984272→		0 204 125 772	















2.0 i.e. Bipower CNG	ABO 03.94-03.02	80			0 204 131 232 ^A	
	ABS 03.94-07.97	80	Fg.-Nr. →5445358		0 204 031 050 ^A	
2.5 D, D 4x4, TD, TD ECO, TD 4x4	ABS 03.94-07.97	62/80/85	Fg.-Nr. →5445358		0 204 031 050 ^A	
2.5 D, TD, TD ECO	ABO 03.94-03.02	62/80/85		LAB,WIF	0 204 031 056 ^A	
					RAB	0 204 131 232 ^A
2.8 D, JTD, JTD EGR, JTD EGR 4x4, JTD 4x4, TD, TD EGR	ABO 10.97-03.02	64/90/94		LAB,WIF	0 204 031 056 ^A	
					RAB	0 204 131 232 ^A

2.0 i.e. Bipower CNG	08.97-11.01	80	Fg.-Nr. 5445359→6194400		L02	BO	0 265 216 530 ^B	
	12.01-03.02	80	Fg.-Nr. 6194401→			BO	0 265 216 709 ^B	
2.5 D, D 4x4, TD ECO	08.97-03.98	62/80	Fg.-Nr. 5445359→6194400		L02	BO	0 265 216 530 ^B	
2.5 TD	08.97-11.01	85	Fg.-Nr. 5445359→6194400		L02	BO	0 265 216 530 ^B	
2.5 TD 4x4	12.01-03.02	85	Fg.-Nr. 6194401→			BO	0 265 216 709 ^B	
2.8 D, D 4x4, JTD, JTD EGR, JTD EGR 4x4, JTD 4x4, TD, TD EGR, TD EGR 4x4, TD 4x4	10.97-11.01	64/90/94	Fg.-Nr. 5445359→6194400		L02	BO	0 265 216 530 ^B	
	12.01-03.02	64/90/94	Fg.-Nr. 6194401→			BO	0 265 216 709 ^B	

Ducato 18 [244]

2.0 i.e., i.e. Bipower CNG, i.e. Bipower CNG 4x4, i.e. Bipower LPG, i.e. Bipower LPG 4x4, i.e. 4x4	ABO 04.02-08.06	71-81			0 204 123 616	25,4
	ABS 04.02-08.06	71-81			0 204 123 615	25,4
2.3 JTD	ABO 04.02-08.06	81			0 204 123 616	25,4
		01.08-12.11	81		0 204 123 616	25,4
	ABS 04.02-08.06	81			0 204 123 615	25,4
		01.08-12.11	81		0 204 123 615	25,4
2.3 JTD EGR	ABO 01.08-12.11	81			0 204 123 616	25,4
	ABS 01.08-12.11	81			0 204 123 615	25,4
2.8 JTD, JTD CGV, JTD EGR, JTD EGR 4x4, JTD 4x4, TD, TD 4x4	ABO 04.02-08.06	90/94/107			0 204 123 616	25,4
	ABS 04.02-08.06	90/94/107			0 204 123 615	25,4

2.0 i.e., i.e. Bipower CNG, i.e. Bipower CNG 4x4, i.e. Bipower LPG, i.e. Bipower LPG 4x4, i.e. 4x4		04.02-08.06	71-81		0 204 125 801	
	ABO 04.02-08.06		71-81		0 204 024 593 ^S	
2.3 JTD	ABS 04.02-08.06		71-81		0 204 024 592 ^S	
					0 204 125 801	
2.3 JTD EGR	ABO 04.02-08.06		81		0 204 125 801	
					0 204 024 593 ^S	
					0 204 024 592 ^S	
					0 204 125 801	
2.8 JTD	ABO 04.02-08.06		94		0 204 024 593 ^S	
					0 204 024 592 ^S	
2.8 JTD CGV	ABO 04.04-08.06		107		0 204 024 593 ^S	
					0 204 024 592 ^S	
2.8 JTD EGR	ABO 04.02-08.06		94	GS	0 204 024 593 ^S	
2.8 JTD EGR 4x4	ABS 04.02-08.06		94	GS	0 204 024 592 ^S	
2.8 JTD, JTD CGV, JTD EGR, JTD EGR 4x4, JTD 4x4, TD, TD 4x4		04.02-08.06	90/94/107		0 204 125 801	
2.8 JTD 4x4	ABO 04.02-08.06		94		0 204 024 593 ^S	
					0 204 024 592 ^S	
2.8 TD	ABO 10.02-08.06		90		0 204 024 593 ^S	
2.8 TD 4x4	ABS 10.02-08.06		90		0 204 024 592 ^S	

		S								
	2.0 i.e. Bipower CNG 4x4	ABO	04.02-08.06	71-81		KOB,KW	0 204 131 232 ^A			
	2.0 i.e. Bipower LPG 4x4, i.e. 4x4	ABS	04.02-08.06	71-81			0 204 031 050 ^A			
	2.0 i.e., i.e. Bipower CNG, i.e. Bipower CNG 4x4, i.e. Bipower LPG, i.e. Bipower LPG 4x4, i.e. 4x4	ABO	04.02-08.06	71-81		FEV	0 204 031 202 ^A			
						FKR	0 204 031 182 ^A			
						FLR,FMR	0 204 031 185 ^A			
	2.3 JTD		01.08-12.11	81				0 204 031 185 ^A		
		ABO	04.02-08.06	81		FEV	0 204 031 202 ^A			
						FKR	0 204 031 182 ^A			
						FLR,FMR	0 204 031 185 ^A			
	2.3 JTD EGR		01.08-12.11	81			0 204 031 185 ^A			
	2.8 JTD CGV	ABO	04.04-08.06	107		FEV	0 204 031 202 ^A			
						FKR	0 204 031 182 ^A			
						FLR,FMR	0 204 031 185 ^A			
	2.8 JTD EGR 4x4	ABO	04.02-08.06	90/94		KOB,KW	0 204 131 232 ^A			
2.8 JTD 4x4					LAB,WIF	0 204 031 056 ^A				
2.8 TD 4x4					RAB,WIF	0 204 131 232 ^A				
	ABS	04.02-08.06	90/94			0 204 031 050 ^A				
2.8 JTD, JTD EGR, JTD EGR 4x4, JTD 4x4, TD	ABO	04.02-08.06	90/94		FEV	0 204 031 202 ^A				
					FKR	0 204 031 182 ^A				
					FLR,FMR	0 204 031 185 ^A				
	2.0 i.e. Bipower CNG 4x4		04.02-08.06	71-81			0 265 216 707 ^B			
	2.0 i.e. Bipower LPG 4x4, i.e. 4x4						0 265 216 709 ^B			
	2.0 i.e., i.e. Bipower CNG, i.e. Bipower LPG	04.02-08.06	71-81				0 265 216 709 ^B			
							0 265 216 709 ^B			
	2.3 JTD	04.02-08.06	81				0 265 232 115 ^B			
		01.08-12.11	81				0 265 232 115 ^B			
	2.3 JTD EGR		01.08-12.11	81			0 265 216 707 ^B			
	2.8 JTD CGV		04.04-08.06	107			0 265 216 707 ^B			
	2.8 JTD EGR 4x4, JTD 4x4, TD 4x4		04.02-08.06	90/94			0 265 216 707 ^B			
	2.8 JTD, JTD EGR, TD		04.02-08.06	90/94			0 265 216 709 ^B			
Ducato 18 [290]										
										
	2.0 Maxi		07.90-02.94	63		LLE	0 204 125 550 ^S			
						RLE	0 204 125 422 ^S			
	2.5 D Maxi, TD Maxi		07.90-02.94	55/70			0 204 125 550 ^S			
Ducato 20 [250]										
										
	120 Multijet Maxi	MFD	06.06-12.14	88		G12,GS	0 204 123 721	26,9		
						G12,HAG	0 204 123 725	26,9		
		OFD	06.06-12.14	88		G10,GS	0 204 123 720	26,9		
						G10,HAG	0 204 123 724	26,9		
	130 Multijet Maxi	MFD	06.06-12.14	96		G12,GS	0 204 123 721	26,9		
						G12,HAG	0 204 123 725	26,9		
		OFD	06.06-12.14	96		G10,GS	0 204 123 720	26,9		
	140 Natural Power					G10,HAG	0 204 123 724	26,9		
		MFD	09.09-12.14	100		G12,GS	0 204 123 721	26,9		
						G12,HAG	0 204 123 725	26,9		
	150 Multijet	OFD	09.09-12.14	100		G10,GS	0 204 123 720	26,9		
						G10,HAG	0 204 123 724	26,9		
		MFD	09.10-12.14	107		G12,GS	0 204 123 721	26,9		
	160 Multijet					G12,HAG	0 204 123 725	26,9		
		OFD	09.10-12.14	107		G10,GS	0 204 123 720	26,9		
	160 Multijet Maxi					G10,HAG	0 204 123 724	26,9		
		MFD	06.06-12.14	115/116		G12,GS	0 204 123 721	26,9		
						G12,HAG	0 204 123 725	26,9		
	OFD	06.06-12.14	115/116		G10,GS	0 204 123 720	26,9			
					G10,HAG	0 204 123 724	26,9			

























FIAT Ducato 20 [250]

	120 Multijet Maxi	06.06-12.14	88		BSS	0 204 125 860	
					BSS	0 204 125 861	
	130 Multijet Maxi	06.06-12.14	96		BSS	0 204 125 860	
					BSS	0 204 125 861	
	140 Natural Power	09.09-12.14	100		BSS	0 204 125 860	
					BSS	0 204 125 861	
	150 Multijet	09.10-12.14	107		BSS	0 204 125 860	
					BSS	0 204 125 861	
	160 Multijet	06.06-12.14	115/116		BSS	0 204 125 860	
					BSS	0 204 125 861	
	120 Multijet Maxi	06.06-03.08	88	Fg.-Nr. →1424797		0 265 233 330 ^F	
					GS,NAA	0 265 231 618 ^B	
		06.06-12.14	88		TW	0 265 234 069 ^T	
					HAG	0 265 232 113 ^B	
		04.08-12.14	88	Fg.-Nr. 1424798→	TW	0 265 230 807 ^T	
						0 265 233 362 ^F	
	130 Multijet Maxi	06.06-03.08	96	Fg.-Nr. →1424797		0 265 233 330 ^F	
					GS,NAA	0 265 231 618 ^B	
		06.06-12.14	96		TW	0 265 234 069 ^T	
					HAG	0 265 232 113 ^B	
		04.08-12.14	96	Fg.-Nr. 1424798→	TW	0 265 230 807 ^T	
						0 265 233 362 ^F	
	140 Natural Power	09.09-12.14	100			0 265 232 113 ^B	
					TW	0 265 230 002 ^T	
						0 265 233 362 ^F	
						0 265 230 807 ^T	
	150 Multijet	09.10-12.14	107			0 265 233 362 ^F	
					NAA	0 265 232 113 ^B	
					TW	0 265 230 002 ^T	
						0 265 230 807 ^T	
	160 Multijet	09.10-12.14	115			0 265 233 362 ^F	
					NAA	0 265 232 113 ^B	
					TW	0 265 230 002 ^T	
						0 265 230 807 ^T	
	160 Multijet Maxi	06.06-03.08	116	Fg.-Nr. →1424797		0 265 233 330 ^F	
					GS,NAA	0 265 231 618 ^B	
		06.06-12.14	116		TW	0 265 234 069 ^T	
					HAG	0 265 232 113 ^B	
		04.08-12.14	116	Fg.-Nr. 1424798→	TW	0 265 230 807 ^T	
						0 265 233 362 ^F	
					GS,NAA	0 265 232 113 ^B	
					TW	0 265 230 002 ^T	

Ducato 110 [250]

	2.3 Multijet	ASR	10.11-12.14	83	305,G12,SSG	0 204 123 721	26,9
						0 204 123 725	26,9
					3U5,G12,SSG	0 204 123 719	25,4
						0 204 123 723	25,4
		OAS	10.11-12.14	83	305,G10,SSG	0 204 123 720	26,9
						0 204 123 724	26,9
					3U5,G10,SSG	0 204 123 718	25,4
						0 204 123 722	25,4
	2.3 Multijet		10.11-12.14	83	305,BSS	0 204 125 860	
					305,BSS	0 204 125 861	

									
2.3 Multijet		10.11-12.14	83			3U5,BSS	0 204 125 858		
						3U5,BSS	0 204 125 859		
Ducato 115 [250]									
									
 2.0 Multijet	ASR	06.11-12.14	85			305,G12,SSG	0 204 123 721	26,9	
						305,G12,SSG	0 204 123 725	26,9	
						3U5,G12,SSG	0 204 123 719	25,4	
						3U5,G12,SSG	0 204 123 723	25,4	
	OAS	06.11-12.14	85			305,G10,SSG	0 204 123 720	26,9	
						305,G10,SSG	0 204 123 724	26,9	
						3U5,G10,SSG	0 204 123 718	25,4	
						3U5,G10,SSG	0 204 123 722	25,4	
 2.0 Multijet		06.11-12.14	85			305,BSS	0 204 125 860		
						305,BSS	0 204 125 861		
						3U5,BSS	0 204 125 858		
						3U5,BSS	0 204 125 859		
Ducato 130 [250]									
									
 2.3 Multijet	ASR	06.11-12.14	96			305,G12,SSG	0 204 123 721	26,9	
						305,G12,SSG	0 204 123 725	26,9	
						3U5,G12,SSG	0 204 123 719	25,4	
						3U5,G12,SSG	0 204 123 723	25,4	
	OAS	06.11-12.14	96			305,G10,SSG	0 204 123 720	26,9	
						305,G10,SSG	0 204 123 724	26,9	
						3U5,G10,SSG	0 204 123 718	25,4	
						3U5,G10,SSG	0 204 123 722	25,4	
 2.3 Multijet		06.11-12.14	96			305,BSS	0 204 125 860		
						305,BSS	0 204 125 861		
						3U5,BSS	0 204 125 858		
						3U5,BSS	0 204 125 859		
Ducato 140 [290]									
									
 3.0 Natual power		10.14→	100			TW	F 00E 520 273		F 00E 591 154 ⁷
							0 204 818 274	25,4	
 3.0 Natual power		10.14→	100			TW	0 204 818 271		
Ducato 150 [250]									
									
 2.3 Multijet	ASR	06.11-12.14	109			305,G12,SSG	0 204 123 721	26,9	
						305,G12,SSG	0 204 123 725	26,9	
						3U5,G12,SSG	0 204 123 719	25,4	
						3U5,G12,SSG	0 204 123 723	25,4	
	OAS	06.11-12.14	109			305,G10,SSG	0 204 123 720	26,9	
						305,G10,SSG	0 204 123 724	26,9	
						3U5,G10,SSG	0 204 123 718	25,4	
						3U5,G10,SSG	0 204 123 722	25,4	
 2.3 Multijet		06.11-12.14	109			305,BSS	0 204 125 860		
						305,BSS	0 204 125 861		
						3U5,BSS	0 204 125 858		
						3U5,BSS	0 204 125 859		





◀ FIAT

Ducato 180 [250..]



	3.0 Multijet	ASR	06.11-12.14	130	305,G12,SSG	0 204 123 721	26,9
					305,G12,SSG	0 204 123 725	26,9
					3U5,G12,SSG	0 204 123 719	25,4
					3U5,G12,SSG	0 204 123 723	25,4
	OAS	06.11-12.14	130	305,G10,SSG	0 204 123 720	26,9	
				305,G10,SSG	0 204 123 724	26,9	
				3U5,G10,SSG	0 204 123 718	25,4	
				3U5,G10,SSG	0 204 123 722	25,4	
	3.0 Multijet		06.11-12.14	130	305,BSS	0 204 125 860	
					305,BSS	0 204 125 861	
					3U5,BSS	0 204 125 858	
					3U5,BSS	0 204 125 859	

Ducato [290]



















	110 Multijet	ASR	05.14→	83	305,SSG	F 00E 520 273		F 00E 591 154 ⁷			
					305,SSG	F 00E 520 272		F 00E 591 154 ⁷			
					3U5,SSG	0 204 818 274	25,4				
					3U5,SSG	0 204 818 275	25,4				
					OAS	05.14→	83	305,SSG	F 00E 520 275		F 00E 591 154 ⁷
								305,SSG	F 00E 520 274		F 00E 591 154 ⁷
	115 Multijet	ASR	05.14→	85	305,SSG	F 00E 520 273		F 00E 591 154 ⁷			
					305,SSG	F 00E 520 272		F 00E 591 154 ⁷			
					3U5,SSG	0 204 818 274	25,4				
					3U5,SSG	0 204 818 275	25,4				
					OAS	05.14→	85	305,SSG	F 00E 520 275		F 00E 591 154 ⁷
								305,SSG	F 00E 520 274		F 00E 591 154 ⁷
130 Multijet	ASR	05.14→	96	305,SSG	F 00E 520 273		F 00E 591 154 ⁷				
				305,SSG	F 00E 520 272		F 00E 591 154 ⁷				
				3U5,SSG	0 204 818 274	25,4					
				3U5,SSG	0 204 818 275	25,4					
				OAS	05.14→	96	305,SSG	F 00E 520 275		F 00E 591 154 ⁷	
							305,SSG	F 00E 520 274		F 00E 591 154 ⁷	
150 Multijet	ASR	05.14→	109	305,SSG	F 00E 520 273		F 00E 591 154 ⁷				
				305,SSG	F 00E 520 272		F 00E 591 154 ⁷				
				3U5,SSG	0 204 818 274	25,4					
				3U5,SSG	0 204 818 275	25,4					
				OAS	05.14→	109	305,SSG	F 00E 520 275		F 00E 591 154 ⁷	
							305,SSG	F 00E 520 274		F 00E 591 154 ⁷	
180 Multijet	ASR	05.14→	130	305,SSG	F 00E 520 273		F 00E 591 154 ⁷				
				305,SSG	F 00E 520 272		F 00E 591 154 ⁷				
				3U5,SSG	0 204 818 274	25,4					
				3U5,SSG	0 204 818 275	25,4					
				OAS	05.14→	130	305,SSG	F 00E 520 275		F 00E 591 154 ⁷	
							305,SSG	F 00E 520 274		F 00E 591 154 ⁷	
					3U5,SSG	0 204 818 272	25,4				
					3U5,SSG	0 204 818 273	25,4				



		S							
	110 Multijet	05.14→	83			3U5,BSS	0 204 818 270		
						3U5,BSS	0 204 818 271		
	115 Multijet	05.14→	85			3U5,BSS	0 204 818 270		
						3U5,BSS	0 204 818 271		
	130 Multijet	05.14→	96			3U5,BSS	0 204 818 270		
						3U5,BSS	0 204 818 271		
	150 Multijet	05.14→	109			3U5,BSS	0 204 818 270		
						3U5,BSS	0 204 818 271		
	180 Multijet	05.14→	130			3U5,BSS	0 204 818 270		
						3U5,BSS	0 204 818 271		
Fiorino Furgao									
	1.0	01.94-07.95	35			JBH,TW	0 204 032 609		
							0 986 481 020	22,2	
						TW,WBH	0 204 032 601		
						WBH	0 204 032 301		22,22
	1.3 MPI	01.03-09.04	49			WBH	0 204 032 601		
		ABO 01.03-09.04	49			JBH ATE	0 986 481 020	22,2	
						BSY	0 204 032 609		
						WBH BSY	0 204 032 301		22,22
	1.3 MPI 8V	01.04-12.13	49			JBH,TW	0 204 032 609		
						TW,WBH	0 204 032 601		
					WBH	0 204 032 301		22,22	
1.7 D	01.04-12.08	52			JBH	0 204 032 609			
					TW,WBH	0 204 032 601			
					WBH	0 204 032 301		22,22	
	1.0	01.94-07.95	35				0 204 032 348		
							0 204 032 359		
						BSY	0 204 032 206		
	1.3 MPI	01.03-09.04	49			D11 BRB,	0 204 032 608		
						BSY			
		ABO 01.03-09.04	49			BSY	0 204 032 348		
	1.3 MPI 8V	01.04-12.13	49				0 204 032 348		
							0 204 032 608		
	1.7 D	01.04-12.08	52				0 204 032 348		
							0 204 032 608		
Fiorino [146..]									
	1.3	ABO 09.93-12.01	49			JBH BSY	0 204 032 609		
	1.4 i.e.	ABO 09.93-12.01	49/52			JBH BSY	0 204 032 609		
	1.6 i.e.	ABO 09.93-12.01	55			JBH BSY	0 204 032 609		
	1.7 D	ABO 09.93-12.01	43/46			JBH ATE	0 986 481 020	22,2	
	1.7 TDS					BSY	0 204 032 609		
	1.3	ABO 09.93-12.01	49				0 204 032 359		0 204 032 226
	1.4 i.e.	ABO 09.93-12.01	49/52				0 204 032 359		0 204 032 226
	1.6 i.e.	ABO 09.93-12.01	55				0 204 032 359		0 204 032 226
	1.7 D, TDS	ABO 09.93-12.01	43/46			BSY	0 204 032 926		0 204 032 226
	1.3	09.93-12.01	49			BSY	0 204 131 202^A		
	1.4 i.e.	09.93-12.01	49/52			BSY	0 204 131 202^A		
	1.6 i.e.	09.93-12.01	55			BSY	0 204 131 202^A		
	1.7 D, TDS	09.93-12.01	43/46			BSY	0 204 131 202^A		
	1.3	09.93-12.01	49				1 273 004 290^H		
	1.4 i.e.	09.93-12.01	49/52				1 273 004 290^H		
	1.6 i.e.	09.93-12.01	55				1 273 004 290^H		
	1.7 D, TDS	09.93-12.01	43/46				1 273 004 290^H		



			S														
◀ FIAT																	
Fiorino [225..]																	
	1.3 Multijet	12.07→	55		LLE,TW			0 204 123 767	22,2								
								0 204 123 784	22,2								
		09.10→	70		LLE,TW				0 204 123 767	22,2							
									0 204 123 784	22,2							
		03.15→	59		LLE				0 204 123 784	22,2							
					RLE,TW				0 204 123 685	22,2							
			70		LLE				0 204 123 784	22,2							
					RLE,TW				0 204 123 685	22,2							
		MFD	12.07→	55		RLE				0 204 123 686	22,2						
										0 204 123 686	22,2						
		OFD	12.07→	55		RLE				0 204 123 685	22,2						
										0 204 123 685	22,2						
		1.4	12.07→	51-57		LLE,TW				0 204 123 767	22,2						
										0 204 123 784	22,2						
1.4 Natural Power	MFD	12.07→	51-57		RLE			0 204 123 686	22,2								
								0 204 123 686	22,2								
1.4 Natural Power	OFD	12.07→	51-57		RLE			0 204 123 685	22,2								
								0 204 123 685	22,2								
	1.3 Multijet	12.07→	55/59/70		BSS,LLE			0 204 749 601									
								BSS,RLE	0 204 777 286								
								BSS,LLE	0 204 125 900								
								BSS,RLE	0 204 125 852								
								1.4	12.07→	51-57		BSS,LLE	0 204 749 601				
												BSS,RLE	0 204 777 286				
1.4 Natural Power				BSS,LLE	0 204 125 900												
				BSS,RLE	0 204 125 852												
	1.3 Multijet	12.07→	55/70					0 986 486 556	20,6								
								1.3 Multijet	06.10→	55					0 265 232 831 ^B		
															09.10→	59/70	
1.4, Natural Power	09.10→	51-57					0 265 232 831 ^B										
	1.3 Multijet	12.07→	55/70					0 265 005 823									
								1.4, Natural Power	12.07→	51-57				0 265 005 823			
Fiorino [225]																	
	1.4	09.14→	54-57					0 265 005 823									
Grande Punto [199]																	
	1.3 Multijet	07.08-12.11	51		LLE,SSG			0 204 123 682	22,2								
			04.10-12.11	62		LLE			0 204 123 682	22,2							
		MFD	07.08-12.11	51/62		RLE			0 204 123 686	22,2							
		OFD	07.08-12.11	51/62		RLE			0 204 123 685	22,2							
	1.3 Multijet	07.08-12.11	51		LLE,TW			0 204 125 850									
					RLE			0 204 125 916									
		04.10-12.11	62		RLE				0 204 125 852								
					RLE			0 204 125 852									
	1.3 Multijet	07.08-12.11	51/62					0 986 486 556	20,6								

		S							
	1.3 Multijet	08.09-12.11	51	Ricam.Nr 1555981→, 1556008→			0 265 232 653 ^B		
		04.10-12.11	62				0 265 232 653 ^B		
	1.3 Multijet	07.08-12.11	51/62				0 265 005 823		
Idea [350]									
									
	1.2 16V	01.04-12.12	59/70		RLE		0 204 123 652	22,2	
		01.07-12.12	59/70		LLE		0 204 123 734	23,8	
		MFD 01.04-12.06	59/70		JBH,LLE		F 026 003 588	23,81	
		OFD 01.04-12.06	59/70		JBH,LLE		F 026 003 641	23,81	
	1.3 Multijet	01.04-12.12	51/66/70		RLE		0 204 123 652	22,2	
	1.3 Multijet	01.07-12.12	51/66/70		LLE		0 204 123 734	23,8	
		MFD 01.04-12.06	51/66		JBH,LLE		F 026 003 588	23,81	
		OFD 01.04-12.06	51/66		JBH,LLE		F 026 003 641	23,81	
	1.4 16V	MFD 01.04-12.06	57/66		JBH,LLE		F 026 003 588	23,81	
	1.4 8V	OFD 01.04-12.06	57/66		JBH,LLE		F 026 003 641	23,81	
	1.4 16V, 8V, 8V LPG	01.04-12.12	57/66		RLE		0 204 123 652	22,2	
		01.07-12.12	57/66		LLE		0 204 123 734	23,8	
	1.6 Multijet	04.08-12.12	88		LLE		0 204 123 734	23,8	
					RLE		0 204 123 652	22,2	
	1.9 Multijet	01.04-12.12	74		RLE		0 204 123 652	22,2	
		01.07-12.12	74		LLE		0 204 123 734	23,8	
		MFD 01.04-12.06	74		JBH,LLE		F 026 003 588	23,81	
		OFD 01.04-12.06	74		JBH,LLE		F 026 003 641	23,81	
	1.2 16V	01.04-12.06	59/70		LLE		0 204 125 814		
		01.04-12.12	59/70		RLE		F 009 D00 884		
		01.07-12.12	59/70		LLE		0 204 125 868		
	1.3 Multijet	01.04-12.06	51/66		LLE		0 204 125 814		
	1.3 Multijet	01.04-11.10	51/66		RLE		F 009 D00 884		
		01.07-11.10	51/66		LLE		0 204 125 868		
	1.3 Multijet	05.08-12.12	70		LLE		0 204 125 868		
					RLE		F 009 D00 884		
	1.4 16V, 8V	01.04-12.06	57/66		LLE		0 204 125 814		
	1.4 16V, 8V, 8V LPG	01.04-12.12	57/66		RLE		F 009 D00 884		
		01.07-12.12	57/66		LLE		0 204 125 868		
	1.6 Multijet	04.08-12.12	88		LLE		0 204 125 868		
					RLE		F 009 D00 884		
	1.9 Multijet	01.04-12.06	74		LLE		0 204 125 814		
		01.04-12.12	74		RLE		F 009 D00 884		
		01.07-12.12	74		LLE		0 204 125 868		
	1.2 16V	01.04-12.12	59/70		LLE		0 986 486 105	15,87	
	1.3 Multijet	01.04-11.10	51		LLE		0 986 486 105	15,87	
	1.4 16V, 8V, 8V LPG	01.04-12.12	57/66		LLE		0 986 486 105	15,87	
	1.6 Multijet	04.08-12.12	88		LLE		0 986 486 105	15,87	
	1.2 16V	01.04-12.12	59/70				0 986 486 597	20,64	
	1.3 Multijet	11.04-11.10	66		LLE		0 986 486 556	20,6	
	1.4 16V, 8V, 8V LPG	01.04-12.12	57/66				0 986 486 597	20,64	
	1.2 16V	01.04-04.06	59/70				0 265 231 673 ^B		
		01.04-05.06	59/70				0 265 234 326 ^T		
		05.06-12.12	59/70				0 265 232 130 ^B		
		06.06-11.06	59/70				0 265 235 431 ^T		
		11.08-09.11	59/70				0 265 230 010 ^T		
	1.3 Multijet	11.04-11.10	66				0 265 232 130 ^B		
		11.08-11.10	66				0 265 230 010 ^T		



		S							
FIAT Idea [350]									
	1.3 Multijet	01.04-04.06	51				0 265 231 673 ^B		
		01.04-05.06	51				0 265 234 326 ^T		
		05.06-11.10	51				0 265 232 130 ^B		
		06.06-11.06	51				0 265 235 431 ^T		
		05.08-12.12	70				0 265 230 010 ^T		
		11.08-11.10	51				0 265 232 130 ^B		
		11.08-11.10	51				0 265 230 010 ^T		
	1.4 16V	01.04-04.06	57/66				0 265 231 673 ^B		
	1.4 8V	01.04-05.06	57/66				0 265 234 326 ^T		
		06.06-11.06	57/66				0 265 235 431 ^T		
1.4 16V, 8V, 8V LPG	05.06-12.12	57/66				0 265 232 130 ^B			
	11.08-09.11	57/66				0 265 230 010 ^T			
1.6 Multijet	04.08-12.12	88				0 265 230 010 ^T			
						0 265 232 130 ^B			
1.9 Multijet	01.04-04.06	74				0 265 231 673 ^B			
	01.04-05.06	74				0 265 234 326 ^T			
	05.06-12.12	74				0 265 232 130 ^B			
	06.06-11.06	74				0 265 235 431 ^T			
	11.08-12.12	74				0 265 230 010 ^T			
	1.2 16V	01.04-05.06	59/70				0 265 005 241		
	1.3 Multijet, Multijet	01.04-05.06	51/66				0 265 005 241		
	1.4 16V, 8V	01.04-05.06	57/66				0 265 005 241		
	1.9 Multijet	01.04-05.06	74				0 265 005 241		
Linea									
	1.9 16V	10.08→	97				0 204 031 318 ^A		
	1.9 16V	10.08→	97				0 265 231 996 ^B		
Linea [110]									
	1.3 JTD	12.08→	63				0 986 486 556	20,6	
		11.08→	66				0 986 486 556	20,6	
	1.3 JTD	12.08→	63				0 204 031 318 ^A		
	1.3 JTD	12.08→	63				0 265 231 996 ^B		
		11.08→	66				0 265 231 996 ^B		
Linea [323]									
	1.3 Multijet	ABO 03.07→	66/70		LLE		0 204 123 764	22,2	
		ABS 03.07→	66/70		GS,LLE		0 204 123 682	22,2	
	1.4	ABO 03.07→	57/88		LLE		0 204 123 764	22,2	
		ABS 03.07→	57/88		GS,LLE		0 204 123 682	22,2	
	1.6, Multijet	ABO 07.08→	77/80		LLE		0 204 123 764	22,2	
		ABS 07.08→	77/80		GS,LLE		0 204 123 682	22,2	
	1.3 Multijet	ABO 03.07→	66/70		LLE		0 204 125 900		
		ABS 03.07→	66/70		LLE,TW		0 204 125 850		
							0 204 125 916		
						0 204 716 043			

		S							
1.4		ABO	03.07→	57/88		LLE	0 204 125 900		
1.4 Turbo		ABS	03.07→	57/88		LLE,TW	0 204 125 850		
							0 204 125 916		
							0 204 716 043		
1.6		ABO	07.08→	77/80		LLE	0 204 125 900		
1.6 Multijet		ABS	07.08→	77/80		LLE,TW	0 204 125 850		
							0 204 125 916		
							0 204 716 043		
	1.3 Multijet		03.07→	66			0 986 486 589	34	
						LLE	0 986 486 556	20,6	
			09.09→	70		LLE	0 986 486 556	20,6	
	1.6 Multijet		10.08→	77		TW	0 986 486 590	34	
	1.3 Multijet		03.07→	66/70			0 204 031 318 ^A		
	1.4, Turbo		03.07→	57/88			0 204 031 318 ^A		
	1.6, Multijet		07.08→	77/80			0 204 031 318 ^A		
	1.3 Multijet		03.07→	66			0 265 230 309 ^T		
						GS,LLE	0 265 231 996 ^B		
						LLE,SSG	0 265 232 000 ^B		
			09.09→	70			0 265 230 309 ^T		
							0 265 231 996 ^B		
	1.4		03.07→	57			0 265 230 309 ^T		
							0 265 231 996 ^B		
	1.4 Turbo		03.07→	88			0 265 230 309 ^T		
							0 265 232 000 ^B		
	1.6		07.08→	80			0 265 230 309 ^T		
	1.6 Multijet		10.08→	77			0 265 230 309 ^T		
							0 265 232 000 ^B		
Marea									
	1.8 MPI 16V		08.99-12.07	97			0 204 125 431 ^S		
	2.0 MPI 20V		05.98-09.00	104			0 204 125 431 ^S		
Marea Weekend									
	1.8 MPI 16V		08.99-12.07	97			0 204 125 431 ^S		
Marea [185]									
	1.2 i 16V		03.99-09.02	60		JBH,LLE	F 026 003 528	22,2	
	1.4 i 12V		10.96-02.99	59		JBH,LLE	F 026 003 528	22,2	
	1.6 i 16V		10.96-03.98	76		RLE	0 204 122 268	22,22	
			10.96-12.02	76		JBH,LLE	F 026 003 528	22,2	
			03.99-12.02	76		RLE	0 204 122 268	22,22	
	1.6 i 16V BI-Power		10.97-09.02	68-76		JBH,LLE	F 026 003 528	22,2	
	1.8 i 16V		10.96-12.97	83		RLE	0 204 122 268	22,22	
			10.96-09.02	83		JBH,LLE	F 026 003 528	22,2	
			03.99-09.02	83	Ricam.Nr →2018321, →0270957, →2022837	RLE	0 204 122 268	22,22	
			08.99-09.02	83	Ricam.Nr 2018322→, 0270958→, 2022838→	RLE	0 204 123 531	22,22	
	1.9 JTD		03.99-09.02	74/77/81		JBH,LLE	F 026 003 528	22,2	
	1.9 JTD S.W.					RLE	0 204 122 268	22,22	
	1.9 TD		10.96-03.98	55,1		JBH,LLE	F 026 003 528	22,2	
						RLE	0 204 122 268	22,22	



		S							
◀ FIAT Marea [185]									
1.9 TD		10.96-03.98	73,6			JBH,LLE	F 026 003 528	22,2	
							RLE	0 204 122 268	22,22
		03.99-09.02	55,1			JBH,LLE	F 026 003 528	22,2	
							RLE	0 204 122 268	22,22
2.0 i 20V		10.96-02.99	108			JBH,LLE	F 026 003 528	22,2	
		03.99-12.02	110/113			RLE	0 204 123 523	22,22	
		ABO 03.99-12.02	110/113			JBH,LLE	F 026 003 528	22,2	
2.4 TD		10.96-03.98	91			RLE	0 204 122 268	22,22	
1.2 i 16V		03.99-09.02	60			LLE	0 204 125 601 ^S		
							0 204 125 724		
1.4 i 12V		10.96-03.98	59			LLE	0 204 125 436		0 204 120 995
		04.98-02.99	59			LLE	0 204 125 601 ^S		
1.6 i 16V		10.96-03.98	76			LLE	0 204 125 436		0 204 120 995
		10.96-12.02	76			RLE	0 204 125 602 ^S		
		04.98-12.02	76			LLE	0 204 125 601 ^S		
		03.99-12.02	76			LLE	0 204 125 724		
		ABO 10.99-12.02	76			LLE	0 204 125 601 ^S		
1.6 i 16V BI-Power		10.97-03.98	68-76			LLE	0 204 125 436		0 204 120 995
		04.98-09.02	68-76			LLE	0 204 125 601 ^S		
		03.99-09.02	68-76			LLE	0 204 125 724		
1.8 i 16V		10.96-03.98	83			LLE	0 204 125 436		0 204 120 995
		10.96-02.99	83			RLE	0 204 125 602 ^S		
		04.98-09.02	83			LLE	0 204 125 601 ^S		
		03.99-09.02	83			LLE	0 204 125 724		
						RLE	0 204 125 602 ^S		
						RLE	0 204 125 729		
1.9 JTD		03.99-09.02	77/81			LLE	0 204 125 601 ^S		
							0 204 125 724		
						RLE	0 204 125 602 ^S		
1.9 JTD S.W.		10.01-09.02	74			LLE	0 204 125 601 ^S		
							0 204 125 724		
1.9 TD		10.96-03.98	55,1			LLE	0 204 125 436		0 204 120 995
			73,6			LLE	0 204 125 436		0 204 120 995
		10.96-02.99	73,6			RLE	0 204 125 602 ^S		
		10.96-09.02	55,1			RLE	0 204 125 602 ^S		
		04.98-02.99	73,6			LLE	0 204 125 601 ^S		
		04.98-09.02	55,1			LLE	0 204 125 601 ^S		
		03.99-09.02	55,1			LLE	0 204 125 724		
2.0 i 20V		10.96-03.98	108			LLE	0 204 125 436		0 204 120 995
		ABO 04.98-02.99	108			LLE	0 204 125 601 ^S		
		03.99-12.02	110/113			LLE	0 204 125 601 ^S		
		ABS 10.96-12.02	108/110/113			LLE	0 204 125 431 ^S		
2.4 JTD		03.99-09.02	100			LLE	0 204 125 431 ^S		
2.4 TD		10.96-03.98	91			RLE	0 204 125 602 ^S		
		10.96-02.99	91			LLE	0 204 125 431 ^S		
1.4 i 12V		10.96-02.99	59				F 026 005 095	19	
							F 026 005 095	19	
1.6 i 16V		10.96-02.99	76			LLE	F 026 005 095	19	
		10.96-12.02	76			RLE	F 026 005 092	19	
		10.98-02.99	76				F 026 005 095	19	
1.6 i 16V BI-Power		10.97-02.99	68-76				F 026 005 095	19	
1.8 i 16V		10.96-02.99	83			LLE	F 026 005 095	19	
		10.96-09.02	83			RLE	F 026 005 092	19	
1.9 JTD		03.99-09.02	77			LLE	F 026 005 095	19	
							RLE	F 026 005 092	19
			08.00-09.02	81			LLE	F 026 005 119	19
						RLE	F 026 005 092	19	
1.9 JTD S.W.		10.01-09.02	74			LLE	F 026 005 119	19	
							RLE	F 026 005 092	19

		S							
	1.9TD	10.96-09.02	55,1/73,6			RLE	F 026 005 092	19	
	2.0i 20V	10.96-02.99	108			LLE	F 026 005 095	19	
						RLE	F 026 005 092	19	
		03.99-12.02	113			LLE	F 026 005 095	19	
						RLE	F 026 005 092	19	
		08.00-09.02	110			LLE	F 026 005 095	19	
		08.00-12.02	110			RLE	F 026 005 092	19	
		05.01-12.02	110			LLE	F 026 005 119	19	
	2.4JTD	10.96-09.02	91/100			LLE	F 026 005 095	19	
	2.4TD					RLE	F 026 005 092	19	
	1.4i 12V	10.96-02.99	59				F 026 005 581	25,4	
	1.6i 16V	10.96-02.99	76				F 026 005 581	25,4	
		03.99-12.02	76			RLE	F 026 005 581	25,4	
		08.00-09.02	76				F 026 005 581	25,4	
	1.6i 16V BI-Power	10.97-02.99	68-76				F 026 005 581	25,4	
	1.8i 16V	10.96-09.02	83				F 026 005 581	25,4	
	1.9JTD, JTD S.W.	03.99-09.02	74/77/81				F 026 005 581	25,4	
	1.9TD	10.96-09.02	55,1/73,6			RLE	F 026 005 581	25,4	
	2.0i 20V	10.96-02.99	108				F 026 005 581	25,4	
		03.99-12.02	110/113			LLE	F 026 005 581	25,4	
	2.4JTD	03.99-09.02	100				0 204 163 077		
	2.4TD	10.96-02.99	91			LLE	0 204 163 077		
						RLE	F 026 005 581	25,4	
	1.2i 16V	03.99-09.02	60				0 204 131 221^A		
	1.4i 12V	10.96-02.99	59				0 204 131 221^A		
	1.6i 16V, i 16V BI-Power	10.96-12.02	68-76				0 204 131 221^A		
	1.8i 16V	10.96-09.02	83				0 204 131 221^A		
	1.9JTD, JTD S.W., TD	10.96-09.02	55,1/73,6/ 74/77/81				0 204 131 221^A		
	2.0i 20V	10.96-12.02	108/110/113				0 204 131 221^A		
	2.4JTD, TD	10.96-09.02	91/100				0 204 131 221^A		
Marengo [259..]									
	1.9D	04.93-12.96	48/66			JBH,LLE	F 026 003 528	22,2	
	1.9D Turbo					RLE	0 204 122 268	22,22	
	1.9D	03.93-05.94	48/66	Ricam.Nr →7510272		LLE	0 204 125 443^S		
	1.9D Turbo						0 204 125 444		0 204 120 517
		04.93-12.96	48/66			RLE	0 204 125 602^S		
		06.94-12.96	48/66	Ricam.Nr VETT.7510273→		LLE	0 204 125 436		
	1.9D	04.94-12.96	48			RLE	F 026 005 092	19	
	1.9D Turbo	04.93-12.96	66			RLE	F 026 005 092	19	
	1.9D	02.90-12.96	48			RLE	0 204 163 080		
	1.9D Turbo	02.90-12.96	66	Ricam.Nr →VET.7379236		RLE	0 204 163 080		
		04.93-12.96	66			RLE	F 026 005 581	25,4	
	1.9D	02.90-12.96	48			LWR	0 204 131 221^A		
	1.9D Turbo	02.90-12.96	66			NIV	0 204 131 221		
	1.9D	04.93-12.96	48				0 265 201 054^H		
	1.9D Turbo	02.90-12.96	66				0 265 208 034^B		
		04.93-12.96	66				0 265 201 054^H		
	1.9D	04.93-12.96	48				0 265 100 042^H		



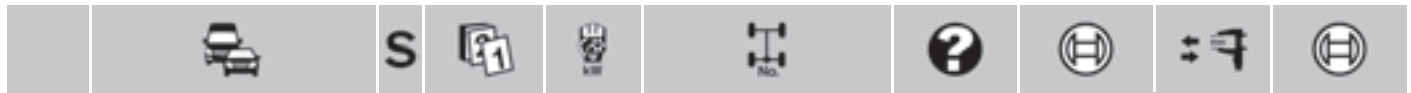

◀ FIAT

Marengo [285..]



	1.9 JTD	03.99-09.02	77/81		JBH,LLE	F 026 003 528	22,2
					RLE	0 204 122 268	22,22
	1.9 TD	01.97-09.02	55,1/73,6		JBH,LLE	F 026 003 528	22,2
		03.99-09.02	55		JBH,LLE	F 026 003 528	22,2
					RLE	0 204 122 268	22,22

	1.9 JTD	03.99-09.02	77/81		LLE	0 204 125 601^S	
					RLE	0 204 125 724	
	1.9 TD	01.97-03.98	55,1/73,6	Ricam.Nr →5051848	LLE	0 204 125 436	0 204 120 995
		01.97-09.02	55,1/73,6		LLE	0 204 125 601^S	
		04.98-09.02	55,1/73,6	Ricam.Nr 5051849→	LLE	0 204 125 724	
		03.99-09.02	55		LLE	0 204 125 601^S	
					RLE	0 204 125 602^S	

	1.9 JTD	03.99-09.02	77		LLE	F 026 005 095	19
					RLE	F 026 005 092	19
		08.00-09.02	81		LLE	F 026 005 119	19
					RLE	F 026 005 092	19
	1.9 TD	03.99-09.02	55		RLE	F 026 005 092	19

	1.9 JTD	03.99-09.02	55/77/81			F 026 005 581	25,4
	1.9 TD						



















	1.9 JTD	01.97-09.02	55/55,1/73,6/			0 204 131 221^A	
	1.9 TD		77/81				

Multipla [186..]



	1.6 Blupower	01.99-12.10	70		JBH,RLE	0 986 481 005	22,2	
	1.6 16V	01.99-12.10	76		JBH,RLE	0 986 481 005	22,2	
		OFD 08.07-12.10	76		JBH,RLE	0 986 481 005	22,2	
	1.6 16V Bipower CNG	01.99-10.00	68-76		JBH,RLE	0 986 481 005	22,2	
		OFD 08.07-12.10	68-76		JBH,RLE	0 986 481 005	22,2	
	1.6 16V LPG	01.01-12.10	68-76		JBH,RLE	0 986 481 005	22,2	
	1.6 16V, 16V Bipower CNG	MFD 09.00-12.10	68-76		LLE	0 204 055 022		
	1.9 JTD	01.99-03.02	77/81		JBH,RLE	0 986 481 005	22,2	
		ABS, 04.02-12.10	85	Ricam.Nr 2178714→	LLE	0 204 123 672	22,2	
		OFD 10.03-12.10	85		LLE	0 204 123 672	22,2	
			10.05-12.10	88		LLE	0 204 123 672	22,2
		MFD 04.02-12.10	85	Ricam.Nr →2178713	LLE	0 204 055 022		
				Ricam.Nr 2178714→	LLE	0 204 123 673	22,2	
			10.03-12.10	85		LLE	0 204 123 673	22,2
			10.05-12.10	88		LLE	0 204 123 673	22,2
			OFD 08.07-12.10	85/88		JBH,RLE	0 986 481 005	22,2











	1.6 Blupower	01.99-03.02	70		LLE	0 204 125 747^S	
	1.6 Blupower, 16V, 16V Bipower CNG, 16V LPG	ABO 09.00-12.10	68-76	Ricam.Nr →2158353	LLE	0 204 125 747^S	
	1.6 16V	01.99-12.10	76		LLE	0 204 125 747^S	
		ABS 09.00-03.02	76		LLE	0 204 125 747^S	
	1.6 16V Bipower CNG	01.99-10.00	68-76		LLE	0 204 125 747^S	
		ABS 01.01-03.02	68-76		LLE	0 204 125 747^S	
	1.6 16V LPG	ABS 01.01-03.02	68-76		LLE	0 204 125 747^S	
	1.6 16V, 16V Bipower CNG	MFD 09.00-12.10	68-76	Ricam.Nr 2158354→	LLE	F 009 D00 655	
	1.9 JTD	01.99-12.00	77		LLE	0 204 125 747^S	
		04.02-12.10	85	Ricam.Nr 2178714→	LLE	F 009 D01 187	

		S								
1.9 JTD		10.03-12.10	85			LLE	F 009	D01 187		
		10.05-12.10	88			LLE	F 009	D01 187		
	ABO	08.00-03.02	81			LLE	0 204	125 747^S		
	MFD	04.02-12.10	85	Ricam.Nr 2158354→2178713		LLE	F 009	D00 655		
	1.6 Blupower, 16V, 16V Bipower CNG, 16V LPG	01.99-12.10	68-76			RLE	0 986	486 556	20,6	
	1.9 JTD	01.99-12.10	77/81/85/88			RLE	0 986	486 556	20,6	
	1.6 Blupower, 16V, 16V Bipower CNG, 16V LPG	01.99-03.02	68-76				0 204	131 221^A		
		04.02-12.10	68-76				0 204	031 120^A		
	1.9 JTD	01.99-03.02	77/81				0 204	131 221^A		
		04.02-12.10	85/88				0 204	031 120^A		
	1.6 Blupower	01.99-03.02	70				0 265	216 526^B		
		04.02-12.10	70				0 265	216 960^B		
	1.6 16V	01.99-03.02	76				0 265	216 526^B		
		04.02-12.10	76				0 265	216 960^B		
	1.6 16V Bipower CNG	01.99-10.00	68-76				0 265	216 526^B		
		01.01-03.02	68-76				0 265	216 526^B		
		04.02-12.10	68-76				0 265	225 044^T		
	1.6 16V Bipower CNG, 16V LPG	04.02-12.10	68-76				0 265	216 960^B		
	1.6 16V LPG	01.01-03.02	68-76				0 265	216 526^B		
	1.9 JTD	01.99-03.02	77/81				0 265	216 526^B		
04.02-12.10		85/88				0 265	216 960^B			
						0 265	225 044^T			
	1.6 16V, 16V Bipower CNG	04.02-12.10	68-76				0 265	005 241		
	1.9 JTD	04.02-12.10	85/88				0 265	005 241		
Palio										
										
	1.3 MPI 16V	07.01-06.05	53/59			WBH	0 204	032 601		
		ABO	01.03-12.04	59			JBH	ATE	0 986 481 020	22,2
							BSY	0 204	032 609	
			10.04-12.07	59			WBH	BSY	0 204 032 301	22,22
						JBH		0 986 481 020	22,2	
	1.3 MPI 16V	ABO	01.03-12.04	59			BSY	0 204	032 348	
							225	BSY	0 204	032 622
	1.3 MPI 16V	01.03-12.07	59				0 265	216 828^B		
Palio [Fase I]										
										
	1.0 MPI 8V	06.96-08.01	45			WBH	0 204	032 601		
		03.98-08.01	45			JBH	ATE	0 986 481 020	22,2	
							BO	0 204	032 609	
							WBH	BO	0 204 032 301	22,22
	1.0 MPI 16V	ABO	08.00-02.03	51,5		JBH		0 986 481 020	22,2	
1.3 MPI 16V			03.00-02.03	59		WBH		0 204 032 601		
	ABO	03.00-02.03	59			JBH	ATE	0 986 481 020	22,2	
							BSY	0 204 032 609		
						WBH	BSY	0 204 032 301	22,22	
	1.0 MPI 8V	03.98-08.01	45				BO	0 204 032 348		
		ABO	11.99-08.01	45		225	BSY	0 204	032 622	















		S							
FIAT Palio [Fase I]									
	1.3 MPI 16V	ABO	03.00-02.03	59			BSY	0 204 032 348	
							225	BSY	0 204 032 622
	1.0 MPI 8V		06.96-02.97	45				0 265 216 418 ^B	
			03.97-08.01	45			0 265 216 550 ^B		
	1.0 MPI 16V		08.00-02.03	51,5			0 265 216 828 ^B		
	1.3 MPI 16V		03.00-09.00	59			0 265 216 550 ^B		
			10.00-02.03	59			0 265 216 828 ^B		
Palio [Fase II]									
	1.3 MPI 16V	ABO	10.04-12.07	59		WBH		0 204 032 601	
			10.04-12.07	59		JBH	ATE	0 986 481 020	22,2
							BSY	0 204 032 609	
						WBH	BSY	0 204 032 301	22,22
	1.3 MPI 16V	ABO	10.04-12.07	59			BSY	0 204 032 348	
							225	BSY	0 204 032 622
	1.3 MPI 16V		10.04-12.07	59				0 265 216 828 ^B	
Palio Weekend [Fase I]									
	1.0 MPI 16V	ABO	09.00-02.03	51		WBH		0 204 032 601	
			09.00-02.03	51		JBH	ATE	0 986 481 020	22,2
							BSY	0 204 032 609	
						WBH	BSY	0 204 032 301	22,22
1.3 MPI 16V	ABO	03.00-02.03	59					0 204 032 601	
								0 986 481 020	22,2
								0 204 032 609	
						WBH	BSY	0 204 032 301	22,22
1.5 MPI 8V	ABO	02.97-04.99	56					0 204 032 601	
								0 986 481 020	22,2
								0 204 032 609	
						WBH	BSY	0 204 032 301	22,22
1.6 MPI 16V	ABO	05.97-03.98	78					0 986 481 020	22,2
								0 204 032 601	
								0 204 032 609	
								0 204 032 301	22,22
		05.97-02.03	78			TW,WBH		0 204 032 601	
		04.98-09.00	78			JBH		0 204 032 609	
		10.00-02.03	78			WBH		0 204 032 301	22,22
						JBH		0 986 481 020	22,2
	1.0 MPI 16V	ABO	09.00-02.03	51				BSY	0 204 032 348
								225	BSY
1.3 MPI 16V	ABO	03.00-02.03	59					BSY	0 204 032 348
								10.00-02.03	59
1.5 MPI 8V	ABO	03.98-04.99	56					BSY	0 204 032 348
1.6 MPI 16V		04.98-09.00	78						0 204 032 348
	1.0 MPI 16V		09.00-02.03	51					0 265 216 828 ^B
	1.3 MPI 16V		03.00-09.00	59					0 265 216 552 ^B
			10.00-02.03	59					0 265 216 828 ^B
	1.5 MPI 8V		02.97-04.99	56					0 265 216 550 ^B
	1.6 MPI 16V		05.97-09.00	78					0 265 216 552 ^B
		10.00-02.03	78						0 265 216 828 ^B



		S							
Palio Weekend [178..]									
									
	1.2 i.e.		08.00-02.02	44				0 204 123 524	22,22
	1.2 i.e. 8V	ABO	03.99-09.01	44		JBH		0 986 481 020	22,2
			10.99-12.08	44		JBH	ATE	0 986 481 020	22,2
			10.01-07.03	44		JBH	BSY	0 204 032 609	
			08.03-12.08	44		JBH	BSY	F 026 003 671	22,2
	1.2 i.e. 8V, i.e. 16V, MPI 16V	ABS	10.01-12.08	44/59		JBH	BSY	F 026 003 604	22,2
	1.2 i.e. 16V	ABO	10.01-12.08	59		JBH	ATE	0 986 481 020	22,2
	1.2 i.e. 16V	ABO	10.01-07.03	59		JBH	BSY	0 204 032 609	
	1.2 MPI 16V		08.03-12.08	59		JBH	BSY	F 026 003 671	22,2
	1.2 MPI 16V	ABO	07.03-07.03	59		JBH	ATE	0 986 481 020	22,2
	1.4 i.e.	ABO	11.97-02.99	51		JBH		0 986 481 020	22,2
			09.98-06.01	51		JBH	ATE	0 986 481 020	22,2
	1.6 i.e. 16V		02.00→	74				0 204 123 524	22,22
			01.01-02.02	76				0 204 123 524	22,22
		ABO	11.97-09.02	76		JBH		0 986 481 020	22,2
			04.98-12.08	76		JBH	ATE	0 986 481 020	22,2
			10.01-07.03	76		JBH	BSY	0 204 032 609	
			08.03-12.08	76		JBH	BSY	F 026 003 671	22,2
		ABS	10.01-12.08	76		JBH	BSY	F 026 003 604	22,2
			03.02-02.04	76				0 204 123 524	22,22
	1.7 TD		08.00-02.02	46/51				0 204 123 524	22,22
		ABO	09.97-10.00	51	Fg.-Nr. 0582136→	JBH		0 986 481 020	22,2
	1.9 D	ABS	01.03-02.04	48				0 204 123 524	22,22
	1.9 D, JTD	ABO	10.01-09.04	51/57		JBH	BSY	F 026 003 671	22,2
	1.9 JTD	ABO	06.02-07.03	80		JBH	ATE	0 986 481 020	22,2
							BSY	0 204 032 609	
			08.03-12.08	80		JBH	BSY	F 026 003 671	22,2
		ABS	06.02-12.08	80		JBH	BSY	F 026 003 604	22,2
	75 1.2 i.e.	ABO	09.97-07.00	54	Fg.-Nr. 0582136→	JBH		0 986 481 020	22,2
	75 1.2 i.e. 8V		10.01-09.04	54		WBH		0 204 032 601	
		ABO	10.01-07.03	54		JBH	ATE	0 986 481 020	22,2
							BSY	0 204 032 609	
			08.03-09.04	54		JBH	BSY	F 026 003 671	22,2
	85 1.2 i.e. 16V		10.01-09.04	63		WBH		0 204 032 601	
		ABO	10.01-07.03	63		JBH	ATE	0 986 481 020	22,2
							BSY	0 204 032 609	
			08.03-09.04	63		JBH	BSY	F 026 003 671	22,2
	100 1.6 i.e. 16V		10.01-09.04	76		WBH		0 204 032 601	
		ABO	09.97-07.00	76		JBH		0 986 481 020	22,2
			10.01-07.03	76		JBH	ATE	0 986 481 020	22,2
							BSY	0 204 032 609	
			08.03-09.04	76		JBH	BSY	F 026 003 671	22,2
	1.2 i.e.		08.00-02.02	44				0 204 125 728	
	1.2 i.e. 8V	ABO	10.01-07.03	44/59			BSY	0 204 032 622	
	1.2 i.e. 16V		08.03-12.08	44/59			BSY	0 204 125 807	
	1.2 MPI 16V	ABS	10.01-12.08	44/59			BSY	0 204 125 806	
	1.6 i.e. 16V		02.00→	74				0 204 125 728	
			01.01-02.02	76				0 204 125 728	
		ABO	10.01-07.03	76			BSY	0 204 032 622	
			08.03-12.08	76			BSY	0 204 125 807	
		ABS	10.01-12.08	76			BSY	0 204 125 806	
			03.02-02.04	76				0 204 125 728	
	1.7 TD		08.00-02.02	46/51				0 204 125 728	
	1.9 D	ABS	01.03-02.04	48				0 204 125 728	
	1.9 D, JTD	ABO	10.01-09.04	51/57			BSY	0 204 125 807	
	1.9 JTD	ABO	06.02-07.03	80			BSY	0 204 032 622	
			08.03-12.08	80			BSY	0 204 125 807	
		ABS	06.02-12.08	80			BSY	0 204 125 806	

		S								
FIAT Palio Weekend [178..]										
	75 1.2 i.e. 8V	ABO	10.01-07.03	54			BSY	0 204 032 622		
			08.03-09.04	54		BSY	0 204 125 807			
	85 1.2 i.e. 16V	ABO	10.01-07.03	63			BSY	0 204 032 622		
			08.03-09.04	63		BSY	0 204 125 807			
	100 1.6 i.e. 16V	ABO	10.01-07.03	76			BSY	0 204 032 622		
			08.03-09.04	76		BSY	0 204 125 807			
	1.2 i.e.		08.00-02.02	44			F 009	D00 769		
	1.6 i.e. 16V		02.00→	74		RLE	F 009	D00 769		
			01.01-02.04	76		F 009	D00 769			
	1.7 TD		08.00-02.02	46/51			F 009	D00 769		
	1.9 D		01.03-02.04	48			F 009	D00 769		
	1.7 TD		08.00-02.02	46/51			F 026	005 581	25,4	
	1.2 i.e.	ABO	08.00-02.02	44				0 204 131 293 ^A		
	1.2 i.e. 8V		10.01-12.08	44				0 204 131 293 ^A		
			ABO	03.99-09.01	44				0 204 131 293 ^A	
	1.2 i.e. 16V		10.01-12.08	59				0 204 131 293 ^A		
	1.2 MPI 16V	ABO	07.03-03.04	59				0 204 131 293 ^A		
	1.4 i.e.	ABO	11.97-06.01	51				0 204 131 293 ^A		
	1.6 i.e. 8V	ABO	06.01-09.02	69				0 204 131 293 ^A		
	1.6 i.e. 16V		02.00→	74					0 204 131 293 ^A	
				07.00-12.08	76				0 204 131 293 ^A	
			ABO	11.97-02.04	76				0 204 131 293 ^A	
	1.7 TD	ABO	09.97-02.02	46/51					0 204 131 293 ^A	
	1.9 D, JTD	ABO	11.00-12.08	46/48/51/57/80					0 204 131 293 ^A	
	75 1.2 i.e., 1.2 i.e. 8V	ABO	09.97-09.04	54					0 204 131 293 ^A	
	85 1.2 i.e. 16V	ABO	10.01-09.04	63					0 204 131 293 ^A	
	100 1.6 i.e. 16V	ABO	09.97-09.04	76					0 204 131 293 ^A	
		1.2 i.e.		08.00-02.02	44				0 265 216 552 ^B	
1.2 i.e. 8V			03.99-09.01	44					0 265 216 552 ^B	
				10.01-12.08	44				0 265 216 828 ^B	
1.2 i.e. 16V, MPI 16V			10.01-12.08	59				0 265 216 828 ^B		
1.4 i.e.			11.97-06.01	51				0 265 216 552 ^B		
1.6 i.e. 8V, i.e. 16V			02.00→	69/74					0 265 216 552 ^B	
				11.97-09.02	76				0 265 216 552 ^B	
1.6 i.e. 16V			10.01-12.08	76					0 265 216 828 ^B	
			03.02-02.04	76					0 265 216 572 ^B	
1.7 TD			09.97-10.00	51					0 265 216 550 ^B	
			08.00-02.02	46					0 265 216 552 ^B	
				51					0 265 216 552 ^B	
1.9 D			11.00-09.01	46					0 265 216 552 ^B	
			01.03-02.04	48					0 265 216 572 ^B	
1.9 D, JTD			10.01-12.08	51/57/80					0 265 216 828 ^B	
75 1.2 i.e.			09.97-09.01	54					0 265 216 550 ^B	
75 1.2 i.e. 8V		10.01-09.04	54					0 265 216 828 ^B		
85 1.2 i.e. 16V		10.01-09.04	63					0 265 216 828 ^B		
100 1.6 i.e. 16V		09.97-09.01	76					0 265 216 552 ^B		
		10.01-09.04	76					0 265 216 828 ^B		
Palio [178..]										
	1.2 i.e. 8V		11.99-09.01	54		WBH		0 204 032 601		
			01.01-09.01	44		WBH		0 204 032 601		
			07.01-12.11	46		TW		0 204 123 524	22,22	
		ABO	11.99-09.01	54		JBH	ATE	0 986 481 020	22,2	
							BSY	0 204 032 609		
						WBH	BSY	0 204 032 301	22,22	

											
1.2 i.e. 8V	ABO	03.00-09.01	54				0 204 123 524	22,22			
		05.00-09.01	44				0 204 123 524	22,22			
		09.00-08.02	44			JBH	0 986 481 020	22,2			
		01.01-09.01	44			JBH	BSY 0 204 032 609				
						WBH	BSY 0 204 032 301	22,22			
		01.01-12.11	44			JBH	ATE 0 986 481 020	22,2			
		10.01-12.11	44			JBH	BSY F 026 003 671	22,2			
1.2 i.e. 8V, i.e. 16V	ABS	10.01-12.11	44/59			JBH	BSY F 026 003 604	22,2			
1.2 i.e. 16V	ABO	10.01-12.11	59			JBH	ATE 0 986 481 020	22,2			
						BSY	F 026 003 671	22,2			
1.3 JTD 16V	ABO	07.03-12.11	52			JBH	ATE 0 986 481 020	22,2			
						BSY	F 026 003 671	22,2			
	ABS	07.03-12.11	52			JBH	BSY F 026 003 604	22,2			
1.4 i.e.	ABO	03.98-05.99	51			JBH	0 986 481 020	22,2			
		08.00-09.01	51			JBH	ATE 0 986 481 020	22,2			
		07.03-12.11	57			JBH	ATE 0 986 481 020	22,2			
						BSY	F 026 003 671	22,2			
	ABS	07.03-12.11	57			JBH	BSY F 026 003 604	22,2			
1.6 i.e. 16V	ABO	03.98-10.99	76			JBH	0 986 481 020	22,2			
		08.00-12.11	76			JBH	ATE 0 986 481 020	22,2			
		07.01-02.04	74				0 204 123 524	22,22			
	ABS	04.02-02.04	74				0 204 123 524	22,22			
1.6 i.e. 16V Sport	ABO	10.01-12.11	76			JBH	ATE 0 986 481 020	22,2			
1.6 i.e. 16V	ABO	10.01-12.11	76			JBH	BSY F 026 003 671	22,2			
1.6 i.e. 16V Sport	ABS	10.01-12.11	76			JBH	BSY F 026 003 604	22,2			
1.9 D		01.03-06.05	48				0 204 123 524	22,22			
	1.2 i.e. 8V	07.01-12.11	46			TW	0 204 125 728				
		ABO	11.99-09.01	54			BSY	0 204 032 348			
							225	BSY 0 204 032 622			
			03.00-09.01	54				0 204 125 728			
			05.00-09.01	44				0 204 125 728			
			01.01-09.01	44				BSY 0 204 032 348			
							225	BSY 0 204 032 622			
			10.01-12.11	44				BSY 0 204 125 807			
			ABS	10.01-12.11	44/59			BSY	0 204 125 806		
			ABO	10.01-12.11	59			BSY	0 204 125 807		
1.3 JTD 16V	ABO	07.03-12.11	52			BSY	0 204 125 807				
		ABS	07.03-12.11	52			BSY	0 204 125 806			
1.4 i.e.	ABO	07.03-12.11	57			BSY	0 204 125 807				
		ABS	07.03-12.11	57			BSY	0 204 125 806			
1.6 i.e. 16V	ABO	07.01-02.04	74				0 204 125 728				
		ABS	04.02-02.04	74				0 204 125 728			
1.6 i.e. 16V	ABO	10.01-12.11	76			BSY	0 204 125 807				
1.6 i.e. 16V Sport	ABS	10.01-12.11	76			BSY	0 204 125 806				
1.9 D		01.03-06.05	48				0 204 125 728				
	1.2 i.e. 8V	03.00-09.01	54			RLE	F 009 D00 769				
		05.00-09.01	44			RLE	F 009 D00 769				
		07.01-12.11	46				F 009 D00 769				
		1.4 i.e.	03.98-09.01	51			RLE	F 009 D00 769			
		1.6 i.e. 16V	03.98-09.01	76			RLE	F 009 D00 769			
			07.01-02.04	74				F 009 D00 769			
1.9 D		01.03-06.05	48			F 009 D00 769					
	1.2 i.e. 8V	03.00-09.01	44/54			RLE	F 026 005 581	25,4			
		1.3 JTD 16V	07.03-12.11	52				0 986 486 556	20,6		
		1.4 i.e.	03.98-09.01	51			RLE	F 026 005 581	25,4		
		1.6 i.e. 16V	03.98-09.01	76			RLE	F 026 005 581	25,4		
	1.2 i.e. 8V	11.99-09.01	54				0 265 216 550 ^B				
		01.01-08.02	44				0 265 216 550 ^B				

		S							
	◀ FIAT Palio [178..]								
	1.2 i.e. 8V	07.01-12.11	46				0 265 216 572 ^B		
		10.01-12.11	44				0 265 216 828 ^B		
	1.2 i.e. 16V	10.01-12.11	59				0 265 216 828 ^B		
	1.3 JTD 16V	07.03-12.11	52				0 265 216 828 ^B		
	1.4 i.e.	03.98-09.01	51				0 265 216 550 ^B		
		07.03-12.11	57				0 265 216 828 ^B		
	1.6 i.e. 16V	03.98-09.01	76				0 265 216 550 ^B		
		07.01-02.04	74				0 265 216 572 ^B		
		10.01-12.11	76				0 265 216 828 ^B		
	1.6 i.e. 16V Sport	10.01-12.11	76				0 265 216 828 ^B		
	1.9 D	01.03-06.05	48				0 265 216 572 ^B		
	Panda Cross [312]								
	0.9 4x4	09.14→	66			RLE	0 986 486 597	20,64	
	Panda [141..]								
	750 fire	07.90-03.03	25			JBH, LLE	F 026 003 226	19,05	
						RLE	0 204 122 237	19,05	
	900 i.e.	04.92-01.00	29	Ricam.Nr →595420		JBH	F 026 003 296	20,6	
		04.92-09.03	29	Ricam.Nr 595421→		JBH	F 026 003 226	19,05	
	1000	07.90-03.97	33			JBH	F 026 003 296	20,6	
	1000 i.e.	07.90-03.97	33			JBH, MEB	F 026 003 226	19,05	
						JBH, MEW	F 026 003 296	20,6	
		01.95-01.00	33	Ricam.Nr →595420		JBH	F 026 003 296	20,6	
		01.95-09.03	33	Ricam.Nr 595421→		JBH	F 026 003 226	19,05	
	1000 Selecta	07.93-03.97	35	Ricam.Nr 8021440→		JBH	F 026 003 296	20,6	
	1000 4x4	07.90-12.95	37			JBH	F 026 003 296	20,6	
	1100 i.e. 4x4	01.95-01.00	40	Ricam.Nr →595420		JBH	F 026 003 296	20,6	
		01.95-09.03	40	Ricam.Nr 595421→		JBH	F 026 003 226	19,05	
	1100 i.e., i.e. Selecta	01.95-09.03	40			JBH	F 026 003 296	20,6	
	1100 i.e., i.e. Selecta, i.e. 4x4	01.93-03.97	37			JBH	F 026 003 296	20,6	
	1100 i.e., i.e. 4x4	12.00-09.03	37	Ricam.Nr 595421→		JBH	F 026 003 226	19,05	
	900 i.e.	09.92-01.00	29	Ricam.Nr 4465253→595420			0 204 125 446		
		02.00-09.03	29	Ricam.Nr 595421→			0 204 125 756		
	1000	07.93-03.97	33	Ricam.Nr 8021440→			0 204 125 446		
	1000 i.e.	09.92-03.97	33	Ricam.Nr VET.4465253→	MEW		0 204 125 446		
		01.95-01.00	33	Ricam.Nr 4465253→595420			0 204 125 446		
		02.00-09.03	33	Ricam.Nr 595421→			0 204 125 756		
	1000 Selecta	07.93-03.97	35	Ricam.Nr 8021440→			0 204 125 449		
	1000 4x4	09.92-12.95	37	Ricam.Nr 4465253→			0 204 125 446		
	1100 i.e.	01.95-09.03	40				0 204 125 446		
	1100 i.e. Selecta	01.93-03.97	37				0 204 125 449		
		01.95-09.03	40				0 204 125 449		
	1100 i.e. 4x4	01.95-01.00	40	Ricam.Nr →595420			0 204 125 446		
		02.00-09.03	40	Ricam.Nr 595421→			0 204 125 756		
	1100 i.e.	01.93-03.97	37				0 204 125 446		
	1100 i.e. 4x4	12.00-09.03	37	Ricam.Nr 595421→			0 204 125 756		
	750 fire	07.90-03.03	25				0 204 131 274		
	900 i.e.	04.92-09.03	29				0 204 131 274		
	1000, i.e., Selecta, 4x4	07.90-09.03	33/35/37				0 204 131 274		
	1100 i.e., i.e. Selecta, i.e. 4x4	01.93-09.03	37/40				0 204 131 274		





Panda [169..]



	1.1 , i.e.	ABO	10.03-12.11	39/40		JBH	F 026 003 648	20,6
	1.1 i.e.	ABS, OFD	10.03-12.09	40		JBH	F 026 003 649	20,6
		MFD	10.03-12.09	40	Fg.-Nr. →0977606		F 026 003 650	20,64
	1.2 , i.e., i.e. LPG, i.e. Natural Power, Natural Power	ABO	10.03-12.11	38-44		JBH	F 026 003 648	20,6
	1.2 i.e.	ABS, OFD	10.03-12.09	44		JBH	F 026 003 649	20,6
	1.2 i.e. LPG, i.e. Natural Power	ABS, OFD	12.06-12.09	38-44		JBH	F 026 003 649	20,6
	1.2 i.e., i.e. LPG, i.e. Natural Power	MFD	10.03-12.09	38-44	Fg.-Nr. →0977606		F 026 003 650	20,64
	1.2 i.e. 4x4	OED	10.04-12.09	44		JBH	F 026 003 649	20,6
	1.3 JTD	ABS, OFD	01.04-12.09	52/55		JBH	F 026 003 649	20,6
		MFD	01.04-12.09	52/55	Fg.-Nr. →0977606		F 026 003 650	20,64
	1.3 JTD, JTD 4x4	ABO	01.04-09.10	52/55		JBH	F 026 003 648	20,6
	1.3 JTD 4x4		09.05-12.09	52			F 026 003 635	22,2
	1.4	ABO	01.09-09.10	74		JBH	F 026 003 648	20,6
	1.4 i.e. 16V	MFD	10.06-12.09	74		JBH	F 026 003 628	22,2
		OFD	10.06-12.09	74			F 026 003 635	22,2

	1.1	ABO	01.09-12.11	39			0 204 125 816	
	1.1 i.e.		10.03-12.09	40			0 204 125 816	
	1.2	ABO	01.09-12.11	44			0 204 125 816	
	1.2 i.e.	ABO	10.03-12.09	44			0 204 125 816	
		ABS, OFD	10.03-12.09	44			0 204 125 816	
	1.2 i.e. LPG	ABO	12.06-12.09	38-44			0 204 125 816	
		ABS, OFD	12.06-12.09	38-44			0 204 125 816	
	1.2 i.e. Natural Power	ABO	12.06-12.09	38-44			0 204 125 816	
		ABS, OFD	12.06-12.09	38-44			0 204 125 816	
	1.2 i.e., i.e. LPG, i.e. Natural Power	MFD	10.03-12.09	38-44			0 204 125 817	
	1.2 i.e. 4x4	OED	10.04-12.09	44			0 204 125 816	
	1.2 Natural Power	ABO	01.09-12.10	38			0 204 125 816	
	1.3 JTD	ABO	01.04-09.10	52			0 204 125 816	
			05.06-12.09	55			0 204 125 816	
		ABS, OFD	01.04-12.09	52			0 204 125 816	
		MFD	05.06-12.09	55			0 204 125 816	
		MFD	01.04-12.09	52/55			0 204 125 817	
	1.3 JTD 4x4		09.05-12.09	52			0 204 125 847	
		ABO	01.09-09.10	52			0 204 125 816	
	1.4	ABO	01.09-09.10	74			0 204 125 816	
	1.4 i.e. 16V		10.06-12.09	74			0 204 125 847	

	1.2 i.e. LPG	ABO	12.06-12.09	38-44			0 204 131 714	
	1.2 i.e. Natural Power							

	1.1		01.09-12.11	39			0 265 230 020 ^T	
							0 265 232 022 ^B	
	1.1 i.e.		10.03-09.06	40			0 265 234 013 ^T	
			10.03-12.09	40	Fg.-Nr. 0977607→		0 265 230 020 ^T	
					Fg.-Nr. 797331→		0 265 232 022 ^B	
	1.2		01.09-12.11	44			0 265 230 020 ^T	
							0 265 232 022 ^B	
			09.10-12.12	51			0 265 230 020 ^T	
							0 265 232 022 ^B	



		S							
FIAT Panda [169..]									
1.2 i.e.		10.03-09.06	44				0 265 234 013 ^T		
		10.03-12.09	44	Fg.-Nr. 0977607→ Fg.-Nr. 797331→	ADE		0 265 230 020 ^T 0 265 232 022 ^B		
		10.06-12.09	44				0 265 235 230 ^T		
1.2 i.e. LPG		12.06-12.09	38-44	Fg.-Nr. 0977607→			0 265 230 020 ^T		
1.2 i.e. Natural Power				Fg.-Nr. 797331→			0 265 232 022 ^B		
1.2 i.e. 4x4		10.04-12.09	44				0 265 230 249 ^T		
						0 265 232 225 ^B			
						0 265 233 364 ^F			
1.2 Natural Power		01.09-12.10	38				0 265 230 020 ^T		
						0 265 232 022 ^B			
1.2 4x4		09.10-05.11	51		TW		0 265 232 225 ^B		
		09.10-12.12	51				0 265 230 249 ^T		
1.3 JTD		01.04-09.06	52				0 265 234 013 ^T		
		01.04-12.09	52	Fg.-Nr. 0977607→ Fg.-Nr. 797331→			0 265 230 020 ^T 0 265 232 022 ^B		
								0 265 234 013 ^T	
		05.06-09.06	55				0 265 230 020 ^T		
		05.06-12.09	55	Fg.-Nr. 0977607→ Fg.-Nr. 797331→			0 265 232 022 ^B 0 265 235 230 ^T		
								0 265 230 020 ^T	
		10.06-12.09	52				0 265 232 022 ^B		
		01.09-09.10	52				0 265 230 249 ^T		
						0 265 232 225 ^B			
1.3 JTD 4x4		09.05-12.09	52				0 265 232 225 ^B		
						0 265 233 364 ^F			
				09.05-09.10	52			0 265 230 249 ^T	
		01.09-09.10	52		TW		0 265 232 225 ^B		
1.3 Multijet		03.10-12.12	55				0 265 230 020 ^T		
						0 265 232 022 ^B			
1.3 Multijet 4x4		03.10-05.11	55	Fg.-Nr. →1979510			0 265 232 225 ^B		
		03.10-12.12	55				0 265 230 249 ^T		
1.4		01.09-09.10	74				0 265 230 020 ^T		
						0 265 232 022 ^B			
1.4 i.e. 16V		10.06-12.09	74				0 265 235 230 ^T		
					Fg.-Nr. 797331→			0 265 232 022 ^B	
1.4 Natural Power		09.10-12.12	51-57				0 265 230 020 ^T		
						0 265 232 022 ^B			
	1.1 i.e.	10.03-09.06	40				0 265 005 241		
	1.2 i.e., i.e. 4x4	10.03-09.06	44				0 265 005 241		
	1.3 JTD	01.04-09.06	52/55				0 265 005 241		
Panda [169]									
	1.2 LPG, 4x4	ABO	01.09-12.12	44		JBH	F 026 003 648	20,6	
	1.2 LPG	ABO	01.09-12.12	44			0 204 125 816		
	1.2 4x4								
	1.2 LPG		01.09-12.12	44			0 265 230 020 ^T		
							0 265 232 022 ^B		
	1.2 4x4		01.09-12.10	44		TW	0 265 230 249 ^T 0 265 232 225 ^B		
Panda [312..]									
	0.9, Natural Power, 4x4		02.12→	44/48/57-63		RLE	0 986 486 597	20,64	
	1.2, LPG		02.12→	51		RLE	0 986 486 597	20,64	



Petra [172..]



	1.2 i.e. 8V	04.04-06.06	44			F 009 D00 769	
--	-------------	-------------	----	--	--	----------------------	--

Punto Cabrio [176]



	60 1.2 i.e.	04.94-08.99	43/44	RLE	0 204 123 524	22,22
		06.94-08.99	43/44	JBH,LLE	F 026 003 266	20,6

85 1.2 i.e. 16V	05.97-08.99	63	JBH,LLE	F 026 003 266	20,6
			RLE	0 204 123 524	22,22

90 1.6 i.e.	04.94-04.97	65	RLE	0 204 123 524	22,22
	05.94-04.97	65	JBH,LLE	F 026 003 266	20,6

	60 1.2 i.e.	06.94-08.99	43/44	LLE	0 204 125 467	
					0 204 125 474^S	

85 1.2 i.e. 16V	05.97-08.99	63	LLE	0 204 125 467	
				0 204 125 474^S	

90 1.6 i.e.	05.94-04.97	65	LLE	0 204 125 467	
	06.94-04.97	65	LLE	0 204 125 474^S	

	60 1.2 i.e.	04.94-08.99	43/44	RLE	0 204 163 104	
					0 204 163 104	

85 1.2 i.e. 16V	05.97-08.99	63	RLE	0 204 163 104	
				0 204 163 104	

90 1.6 i.e.	04.94-04.97	65	RLE	0 204 163 104	
				0 204 163 104	

	60 1.2 i.e.	04.94-08.99	43/44	RLE	F 026 005 587	25,4
					F 026 005 587	25,4

85 1.2 i.e. 16V	05.97-08.99	63	RLE	F 026 005 587	25,4
				F 026 005 587	25,4

90 1.6 i.e.	04.94-04.97	65	RLE	F 026 005 587	25,4
				F 026 005 587	25,4

	60 1.2 i.e.	05.97-08.99	44	LAB	0 204 131 233^A	
				RAB	0 204 131 234^A	

ABO	04.94-06.95	43/44	LAB	0 986 482 037	
			RAB	0 986 482 038	

	07.95-08.99	43/44	LAB	0 204 131 265	
			RAB	0 204 131 266	

ABS	04.94-04.97	44	LAB	0 204 131 233^A	
			RAB	0 204 131 234^A	

	05.95-04.97	43	LAB	0 204 131 233^A	
			RAB	0 204 131 234^A	

85 1.2 i.e. 16V	05.97-08.99	63	LAB	0 204 131 233^A	
			RAB	0 204 131 234^A	

ABO	05.97-08.99	63	LAB	0 204 131 265	
			RAB	0 204 131 266	

90 1.6 i.e.	04.94-04.97	65	LAB	0 204 131 233^A	
			RAB	0 204 131 234^A	

ABO	04.94-06.95	65	LAB	0 986 482 037	
			RAB	0 986 482 038	

	07.95-04.97	65	LAB	0 204 131 265	
			RAB	0 204 131 266	

	60 1.2 i.e.	04.94-04.97	44		0 265 204 014^B	
		05.95-04.97	43		0 265 204 014^B	
		05.97-08.99	44		0 265 216 418^B	

85 1.2 i.e. 16V	05.97-08.99	63		0 265 216 418^B	
				0 265 204 014^B	

90 1.6 i.e.	04.94-04.97	65		0 265 204 014^B	
				0 265 204 014^B	





FIAT

Punto Evo [199]



	1.2 8V	10.09-12.11	48/50-51	LLE,SSG	0 204 123 682	22,2	
		MFD	10.09-12.11	48/50-51	RLE	0 204 123 686	22,2
		OFD	10.09-12.11	48/50-51	RLE	0 204 123 685	22,2
	1.3 Multijet	10.09-12.11	51/55-56/62/66/70-93	LLE,SSG	0 204 123 682	22,2	
		MFD	10.09-12.11	51/55-56/62/66/70-93	RLE	0 204 123 686	22,2
		OFD	10.09-12.11	51/55-56/62/66/70-93	RLE	0 204 123 685	22,2
	1.4 Abarth	06.10-12.12	120	RLE	0 204 123 687	23,81	
	1.4 LPG, 16V, 8V, 8V Natural	10.09-12.11	55/56-66/77/99	LLE,SSG	0 204 123 682	22,2	
		MFD	10.09-12.11	55/56-66/77/99	RLE	0 204 123 686	22,2
		OFD	10.09-12.11	55/56-66/77/99	RLE	0 204 123 685	22,2
	1.6 Multijet	10.09-12.11	88	LLE,SSG	0 204 123 682	22,2	
		MFD	10.09-12.11	88	RLE	0 204 123 686	22,2
		OFD	10.09-12.11	88	RLE	0 204 123 685	22,2

	1.2 8V	10.09-12.11	48/50-51	BSS,RLE	0 204 777 286	
				BSS,LLE	0 204 125 916	
				BSS,RLE	0 204 125 852	
	1.3 Multijet	10.09-12.11	51/55-56/ 62/66/ 70-93	BSS,RLE	0 204 777 286	
				BSS,LLE	0 204 125 916	
				BSS,RLE	0 204 125 852	
	1.4 Abarth	06.10-12.12	120	LLE	0 204 125 917	
	1.4 LPG, 16V, 8V, 8V Natural	10.09-12.11	55/56-66/ 77/99	BSS,RLE	0 204 777 286	
				BSS,LLE	0 204 125 916	
				BSS,RLE	0 204 125 852	
	1.6 Multijet	10.09-12.11	88	BSS,RLE	0 204 777 286	
				BSS,LLE	0 204 125 916	
				BSS,RLE	0 204 125 852	

	1.3 Multijet	10.09-12.11	51/55-56/62 66		0 986 486 556	20,6
					0 986 486 556	20,6
				GS	0 986 486 591	34
				SSG	0 986 486 589	34
					0 986 486 556	20,6
					0 986 486 589	34
	1.6 Multijet	10.09-12.11	88	TW	0 986 486 590	34

	1.2 8V	10.09-12.11	48/50-51		0 265 232 653^B	
	1.3 Multijet	10.09-12.11	51/55-56/62/66/70-93		0 265 232 653^B	
	1.4 LPG, 16V, 8V, 8V Natural	10.09-12.11	55/56-66/77/99		0 265 232 653^B	
	1.6 Multijet	10.09-12.11	88		0 265 232 653^B	

	1.2 8V	10.09-12.11	48/50-51		0 265 005 823	
	1.3 Multijet	10.09-12.11	51/55-56/62/66/70-93		0 265 005 823	
	1.4 Abarth, LPG, 16V, 8V, 8V Natural	10.09-12.12	55/56-66/77/99/120		0 265 005 823	
	1.6 Multijet	10.09-12.11	88		0 265 005 823	

Punto Grande Abarth SS [199]

















	1.4	10.07-12.10	132	RLE	0 204 123 687	23,81
	1.4	10.07-12.10	132	LLE	0 204 125 917	
				RLE	0 204 125 853	
	1.4	10.07-12.10	132		0 986 486 592	34

			S							
	1.4		10.07-12.10	132				0 265	005 823	
Punto Grande Abarth [199]										
	1.4		10.07-12.10	114			RLE	0 204	123 687	23,81
	1.4		10.07-12.10	114			LLE	0 204	125 917	
							RLE	0 204	125 853	
	1.4		10.07-12.10	114				0 986	486 592	34
	1.4		10.07-12.10	114				0 265	005 823	
Punto Grande [199]										
	1.2		09.10-12.11	51			LLE	0 204	123 682	22,2
		MFD	10.05-09.06	48	Ricam.Nr →168567, →1166857		LLE,SSG	0 204	123 683	22,2
			10.05-12.11	48			LLE,SSG	0 204	123 709	22,2
			10.06-12.11	48			RLE	0 204	123 686	22,2
			10.06-12.11	48	Ricam.Nr 168568→, 1166858→		LLE,SSG	0 204	123 682	22,2
			09.10-12.11	51			RLE	0 204	123 686	22,2
		OFD	10.05-12.11	48			LLE	0 204	123 682	22,2
			10.05-12.11	48			RLE	0 204	123 685	22,2
			09.10-12.11	51			RLE	0 204	123 685	22,2
	1.3 Multijet	OFD	10.05-12.09	66			LLE	0 204	123 682	22,2
			10.05-12.09	66			RLE	0 204	123 685	22,2
	1.3 Multijet	MFD	10.05-09.06	55/66	Ricam.Nr →168567, →1166857		LLE,SSG	0 204	123 683	22,2
	1.3 Multijet		10.05-12.11	55/66			LLE,SSG	0 204	123 709	22,2
			10.06-12.11	55/66	Ricam.Nr 168568→, 1166858→		RLE	0 204	123 686	22,2
			10.06-12.11	55/66			LLE,SSG	0 204	123 682	22,2
	1.3 Multijet		09.08-12.11	55			LLE	0 204	123 682	22,2
		OFD	10.05-12.11	55			LLE	0 204	123 682	22,2
			10.05-12.11	55			RLE	0 204	123 685	22,2
	1.4	MFD	10.05-09.06	57/70	Ricam.Nr →168567, →1166857		LLE,SSG	0 204	123 683	22,2
			10.05-12.11	57/70			LLE,SSG	0 204	123 709	22,2
			10.05-12.11	57/70			RLE	0 204	123 686	22,2
			06.06-09.06	55	Ricam.Nr →168567, →1166857		LLE,SSG	0 204	123 683	22,2
			06.06-09.06	55			LLE,SSG	0 204	123 709	22,2
			06.06-12.11	55			RLE	0 204	123 686	22,2
			10.06-12.11	55	Ricam.Nr 168568→, 1166858→		LLE,SSG	0 204	123 682	22,2
			10.06-12.11	55			LLE,SSG	0 204	123 682	22,2
			06.07-12.09	88	Ricam.Nr 168568→, 1166858→		LLE,SSG	0 204	123 682	22,2
			06.07-12.09	88			LLE,SSG	0 204	123 682	22,2
			06.07-12.09	88			RLE	0 204	123 686	22,2
		OFD	10.05-12.11	57/70			LLE	0 204	123 682	22,2
			10.05-12.11	57/70			RLE	0 204	123 685	22,2
			06.06-12.11	55			LLE	0 204	123 682	22,2
			06.06-12.11	55			RLE	0 204	123 685	22,2
			06.07-12.09	88			LLE	0 204	123 682	22,2
			06.07-12.09	88			RLE	0 204	123 685	22,2
	1.4 CNG	MFD	09.08-12.11	56			LLE,SSG	0 204	123 682	22,2
		OFD	09.08-12.11	56			LLE	0 204	123 682	22,2

















		S								
	◀ FIAT Punto Grande [199]									
1.4 CNG	MFD	09.08-12.11	56			RLE	0 204 123 686	22,2		
1.4 LPG	OFD	09.08-12.11	56			RLE	0 204 123 685	22,2		
1.4 LPG	MFD	09.08-12.11	56			LLE,SSG	0 204 123 682	22,2		
	OFD	09.08-12.11	56			LLE	0 204 123 682	22,2		
1.6 Multijet		08.08-12.09	88			LLE,SSG	0 204 123 682	22,2		
	MFD	08.08-12.09	88			RLE	0 204 123 686	22,2		
	OFD	08.08-12.09	88			RLE	0 204 123 685	22,2		
1.9 Multijet	MFD	10.05-09.06	85/88/96	Ricam.Nr →168567, →1166857		LLE,SSG	0 204 123 683	22,2		
						LLE,SSG	0 204 123 709	22,2		
		10.05-12.09	85/88/96			RLE	0 204 123 686	22,2		
		10.06-12.09	85/88/96	Ricam.Nr 168568→, 1166858→		LLE,SSG	0 204 123 682	22,2		
	OFD	10.05-12.09	85/88/96			LLE	0 204 123 682	22,2		
						RLE	0 204 123 685	22,2		
	1.2	10.05-12.09	48			LLE,TW	0 204 125 850			
							0 204 125 916			
		10.05-12.11	48			RLE	0 204 125 852			
		01.10-12.11	48			LLE	0 204 125 916			
		09.10-12.11	51			LLE	0 204 125 916			
					RLE	0 204 125 852				
1.3 Multijet	10.05-12.09	66				LLE,TW	0 204 125 850			
							0 204 125 916			
						RLE	0 204 125 852			
1.3 Multijet	10.05-12.11	55				LLE,TW	0 204 125 850			
							0 204 125 916			
						RLE	0 204 125 852			
1.4	09.08-12.11	55				LLE	0 204 125 916			
							0 204 125 916			
1.4	03.06-12.09	70/88				LLE,TW	0 204 125 850			
							0 204 125 916			
						RLE	0 204 125 852			
1.4	10.05-12.09	55/56/57				LLE,TW	0 204 125 850			
1.4 CNG							0 204 125 916			
1.4 LPG	10.05-12.11	55/56/57				RLE	0 204 125 852			
	01.10-12.11	55/56/57				LLE	0 204 125 916			
1.6 Multijet	08.08-12.09	88				LLE,TW	0 204 125 850			
							0 204 125 916			
						RLE	0 204 125 852			
1.9 Multijet	10.05-12.09	85/88/96				LLE,TW	0 204 125 850			
							0 204 125 916			
						RLE	0 204 125 852			
	1.3 Multijet	10.05-12.09	66				0 986 486 556	20,6		
						SSG	0 986 486 591	34		
						SSG	0 986 486 589	34		
							0 986 486 556	20,6		
							0 986 486 590	34		
1.6 Multijet	08.08-12.09	88				0 986 486 590	34			
1.9 Multijet	10.05-12.09	85/88/96				0 986 486 590	34			
	1.2	10.05-09.06	48	Ricam.Nr →168567, →1166857			0 265 231 536 ^B			
							0 265 235 232 ^T			
		10.06-05.07	48	Ricam.Nr 168568→, 1166858→			0 265 231 927 ^B			
							0 265 234 545 ^T			
		06.07-02.08	48				0 265 235 433 ^T			
		08.09-12.11	48	Ricam.Nr 1555981→, 1556008→			0 265 232 653 ^B			
		09.10-12.11	51				0 265 232 653 ^B			
		1.3 Multijet	10.05-09.06	66	Ricam.Nr →168567, →1166857			0 265 231 536 ^B		
								0 265 235 232 ^T		
			10.06-05.07	66	Ricam.Nr 168568→, 1166858→			0 265 231 927 ^B		
						0 265 234 545 ^T				
	06.07-02.08	66				0 265 235 433 ^T				
	08.09-12.09	66	Ricam.Nr 1555981→, 1556008→			0 265 232 653 ^B				









		S								
1.3 Multijet		10.05-09.06	55	Ricam.Nr →168567, →1166857			0 265 231 536 ^B			
							0 265 235 232 ^T			
		10.06-05.07	55	Ricam.Nr 168568→, 1166858→			0 265 231 927 ^B			
							0 265 234 545 ^T			
		06.07-02.08	55				0 265 235 433 ^T			
1.4		09.08-12.11	55				0 265 232 653 ^B			
		10.05-09.06	57/70	Ricam.Nr →168567, →1166857			0 265 231 536 ^B			
1.4		06.06-09.06	55	Ricam.Nr →168567, →1166857			0 265 231 536 ^B			
							0 265 235 232 ^T			
		10.06-05.07	55	Ricam.Nr 168568→, 1166858→			0 265 231 927 ^B			
							0 265 234 545 ^T			
		57/70		Ricam.Nr 168568→, 1166858→			0 265 231 927 ^B			
							0 265 234 545 ^T			
		06.07-02.08	55				0 265 235 433 ^T			
			57/70				0 265 235 433 ^T			
			88				0 265 235 433 ^T			
		08.09-12.09	88	Ricam.Nr 1555981→, 1556008→			0 265 232 653 ^B			
		08.09-12.11	55	Ricam.Nr 1555981→, 1556008→			0 265 232 653 ^B			
			57/70	Ricam.Nr 1555981→, 1556008→			0 265 232 653 ^B			
		1.4 CNG, LPG	08.09-12.11	56	Ricam.Nr 1555981→, 1556008→			0 265 232 653 ^B		
		1.6 Multijet	08.09-12.09	88	Ricam.Nr 1555981→, 1556008→			0 265 232 653 ^B		
		1.9 Multijet		10.05-09.06	88/96	Ricam.Nr →168567, →1166857			0 265 231 536 ^B	
							0 265 235 232 ^T			
06.06-09.06	85			Ricam.Nr →168567, →1166857			0 265 231 536 ^B			
							0 265 235 232 ^T			
10.06-05.07	85			Ricam.Nr 168568→, 1166858→			0 265 231 927 ^B			
							0 265 234 545 ^T			
88/96				Ricam.Nr 168568→, 1166858→			0 265 231 927 ^B			
							0 265 234 545 ^T			
06.07-02.08	85						0 265 235 433 ^T			
	88/96						0 265 235 433 ^T			
08.09-12.09	88/96	Ricam.Nr 1555981→, 1556008→			0 265 232 653 ^B					
	1.2	10.05-12.11	48/51				0 265 005 823			
		1.3 Multijet, Multijet	10.05-12.11	55/66				0 265 005 823		
		1.4, CNG, LPG	10.05-12.11	55/56/57/70/88				0 265 005 823		
		1.6 Multijet	08.08-12.09	88				0 265 005 823		
		1.9 Multijet	10.05-12.09	85/88/96				0 265 005 823		
Punto GT [176]										
										
	1.4 i.e. Turbo	08.93-08.99	96/98			LLE	0 204 122 267	22,22		
						RLE	0 204 123 524	22,22		
	1.4 i.e. Turbo	08.93-08.99	96/98			LLE	0 204 125 467			
	1.4 i.e. Turbo	08.93-04.97	96/98			RLE	0 204 163 104			
	1.4 i.e. Turbo	08.93-04.97	98			LAB	0 204 131 233 ^A			
						RAB	0 204 131 234 ^A			
		03.96-04.97	96			LAB	0 204 131 233 ^A			
						RAB	0 204 131 234 ^A			
		ABS	05.97-08.99	96			LAB	0 204 131 233 ^A		
					RAB	0 204 131 234 ^A				
	1.4 i.e. Turbo	08.93-03.96	98				0 265 204 010 ^B			
		03.96-08.99	96				0 265 216 425 ^B			
		04.96-04.97	98				0 265 216 425 ^B			



◀ FIAT									
Punto Van [276]									
	1.1 i.e.	05.97-08.99	40		JBH,LLE	F 026 003 266	20,6		
					RLE	0 204 123 524	22,22		
	1.7 D, TD, TD SOFT	05.97-08.99	42/46/51/53		JBH,LLE	F 026 003 266	20,6		
					RLE	0 204 123 524	22,22		
	1.1 i.e.	05.97-08.99	40		LLE	0 204 125 467			
						0 204 125 474^S			
	1.7 D, TD, TD SOFT	05.97-08.99	42/46/51/53		LLE	0 204 125 467			
						0 204 125 474^S			
	1.1 i.e.	05.97-08.99	40		RLE	0 204 163 104			
	1.7 D, TD, TD SOFT	05.97-08.99	42/46/51/53		RLE	0 204 163 104			
	1.1 i.e.	05.97-08.99	40		RLE	F 026 005 587	25,4		
	1.1 i.e.	05.97-08.99	40		LAB	0 986 482 037			
					RAB	0 986 482 038			
	1.7 D	ABO 05.97-08.97	42/46		LAB	0 986 482 037			
	1.7 TD SOFT				RAB	0 986 482 038			
	1.7 D, TD, TD SOFT	05.97-08.99	42/46/51/53		LAB	0 204 131 233^A			
					RAB	0 204 131 234^A			
	1.7 TD	ABO 05.97-08.97	51/53		LAB,RLE	0 986 482 037			
					RAB,RLE	0 986 482 038			
	1.1 i.e.	05.97-08.99	40			0 265 216 418^B			
	1.7 D, TD, TD SOFT	05.97-08.99	42/46/51/53			0 265 216 418^B			
Punto Van [288]									
	1.2 Bipower	07.03-12.10	44		JBH,RLE	0 986 481 005	22,2		
		ABS 07.03-12.10	44		AG,JBH,LLE	F 026 003 604	22,2		
					GS,JBH,LLE	F 026 003 603	20,64		
	1.2 i8V	07.03-12.10	44		JBH,RLE	0 986 481 005	22,2		
		ABO 07.99-06.03	44	Ricam.Nr →0209586, →0697747, →2157164	LLE	0 204 123 605	20,6		
				Ricam.Nr →2653019, →4424965, →5119345	LLE	0 204 123 605	20,6		
		07.03-12.10	44		LLE	0 204 123 605	20,6		
		ABS 07.99-06.03	44		JBH,RLE	0 986 481 005	22,2		
				Ricam.Nr →0201866, →0691037, →2649568	LLE	0 204 123 605	20,6		
				Ricam.Nr →4418627, →5114354, →2153486	LLE	0 204 123 605	20,6		
				Ricam.Nr 0209587→, 0697748→, 2653020→	JBH,LLE	F 026 003 603	20,64		
				Ricam.Nr 4424966→, 5119345→, 2157165→	JBH,LLE	F 026 003 603	20,64		
		07.03-12.10	44		GS,JBH,LLE	F 026 003 603	20,64		
	1.2 LPG	08.07-12.10	44		AG,JBH,LLE	F 026 003 604	22,2		
		ABO 08.07-12.10	44		GS,LLE	0 204 123 605	20,6		
		ABS 08.07-12.10	44		GS,JBH,LLE	F 026 003 603	20,64		
		OFD 08.07-12.10	44		JBH,RLE	0 986 481 005	22,2		
	1.3 MJTD 16V	ABO 07.03-12.10	51		LLE	0 204 123 605	20,6		
					JBH,RLE	0 986 481 005	22,2		
		ABS, 07.03-12.10	51		JBH,LLE	F 026 003 604	22,2		
		OFD			JBH,RLE	0 986 481 005	22,2		

									
1.3 MJTD 16V	MFD	07.03-12.10	51				JBH,LLE	F 026 003 628	22,2
1.9 D		05.99-06.03	44				JBH,RLE	0 986 481 005	22,2
	ABO	05.99-06.03	44				LLE	0 204 123 606	22,2
1.9 D	ABS	05.99-06.03	44/63				LLE	0 204 123 606	22,2
1.9 JTD									
							Ricam.Nr →0201866, →0691037, →2649568		
							LLE	0 204 123 606	22,2
							Ricam.Nr →4418627, →5114354, →2153486		
							LLE	0 204 123 606	22,2
							Ricam.Nr 0209587→, 0697748→, 2157165→		
							JBH,LLE	F 026 003 604	22,2
							Ricam.Nr 2653020→, 4424966→, 5119346→		
							JBH,LLE	F 026 003 604	22,2
1.9 JTD		05.99-06.03	63				JBH,RLE	0 986 481 005	22,2
	ABO	05.99-06.03	63				LLE	0 204 123 606	22,2
1.9 JTD 8V	ABO	07.03-12.10	63				LLE	0 204 123 605	20,6
	ABS,	07.03-12.10	63				JBH,LLE	F 026 003 604	22,2
	OFD								
	MFD	07.03-12.10	63				JBH,LLE	F 026 003 628	22,2
	OFD	07.03-12.10	63				JBH,RLE	0 986 481 005	22,2
	1.2 Bipower, i 8V, LPG	07.99-12.10	44				LLE	0 204 125 731	
	1.3 MJTD 16V	07.03-12.10	51				LLE	0 204 125 731	
	1.9 D, JTD, JTD 8V	05.99-12.10	44/63				LLE	0 204 125 731	
	1.2 Bipower, i 8V, LPG	07.99-12.10	44				LLE	0 986 486 073	15,87
	1.3 MJTD 16V	07.03-10.03	51				LLE	0 986 486 077	15,87
		11.03-12.10	51				LLE	0 986 486 092	15,87
	1.9 D	05.99-06.03	44				LLE	0 986 486 077	15,87
	1.9 JTD	05.99-06.03	63				LLE	0 986 486 077	15,87
	1.9 JTD 8V	07.03-10.03	63				LLE	0 986 486 077	15,87
		11.03-12.10	63				LLE	0 986 486 092	15,87
	1.2 Bipower	07.03-12.10	44					0 986 486 597	20,64
	1.2 i 8V	07.99-07.02	44				LLE	0 986 486 597	20,64
		07.99-12.10	44				RLE	0 986 486 563	20,6
		07.03-12.10	44				LLE	0 986 486 597	20,64
	1.2 LPG	08.07-12.10	44				LLE	0 986 486 597	20,64
	1.3 MJTD 16V	07.03-12.10	51					0 986 486 556	20,6
	1.9 D, JTD, JTD 8V	05.99-12.10	44/63					0 986 486 556	20,6
	1.2 Bipower, i 8V	ABO 07.03-12.10	44					0 204 031 179^A	
	1.3 MJTD 16V	ABO 07.03-12.10	51					0 204 031 179^A	
	1.9 D	05.99-02.02	44					0 204 031 180^A	
		03.02-06.03	44					0 204 031 179^A	
	1.9 JTD	05.99-02.02	63					0 204 031 180^A	
		03.02-06.03	63					0 204 031 179^A	
	1.9 JTD 8V	ABO 07.03-12.10	63					0 204 031 179^A	
	1.2 Bipower, i 8V	07.03-12.10	44					0 265 231 332^B	
	1.2 i 8V	07.99-05.02	44				Ricam.Nr →284749, →4546420, →5171879	0 265 216 619^B	
		06.02-06.03	44				Ricam.Nr 284750→, 4546421→, 5171880→	0 265 216 946^F	
	1.2 LPG	08.07-12.10	44					0 265 231 332^B	
								0 265 234 007^T	
	1.3 MJTD 16V	07.03-12.10	51					0 265 231 332^B	
								0 265 234 007^T	
	1.9 D	05.99-05.02	44				Ricam.Nr →284749, →4546520, →5171879	0 265 216 623^B	
		06.02-06.03	44				Ricam.Nr 284750→, 4546421→, 5171880→	0 265 216 946^F	
	1.9 JTD	05.99-05.02	63				Ricam.Nr →284749, →4546520, →5171879	0 265 216 623^B	
		06.02-06.03	63				Ricam.Nr 284750→, 4546421→, 5171880→	0 265 216 946^F	
	1.9 JTD 8V	07.03-12.10	63					0 265 231 332^B	
								0 265 234 007^T	

			S							
◀ FIAT Punto Van [288]										
	1.2 LPG	08.07-12.10	44					0 265 005 241		
	1.3 MJTD 16V	07.03-12.10	51					0 265 005 241		
	1.9 JTD 8V	07.03-12.10	63					0 265 005 241		
Punto [176]										
	1.7 D	08.93-08.99	42/46/51-53			RLE		0 204 123 524	22,22	
	1.7 TD	06.94-08.99	42/46/51-53			JBH,LLE		F 026 003 266	20,6	
	55 1.1 i.e.	08.93-08.99	40			RLE		0 204 123 524	22,22	
		06.94-08.99	40			JBH,LLE		F 026 003 266	20,6	
	60 1.2 i.e.	08.93-05.94	43			RLE		0 204 123 524	22,22	
	60 1.2 i.e.	06.94-08.99	44			JBH,LLE		F 026 003 266	20,6	
	60 1.2 i.e. Selecta					RLE		0 204 123 524	22,22	
	75 1.2 i.e.	08.93-08.99	54			RLE		0 204 123 524	22,22	
		06.94-08.99	54			JBH,LLE		F 026 003 266	20,6	
	85 1.2 i.e. 16V	05.97-08.99	63			JBH,LLE		F 026 003 266	20,6	
						RLE		0 204 123 524	22,22	
	90 1.6 i.e.	01.94-04.97	65			RLE		0 204 123 524	22,22	
06.94-04.97		65			JBH,LLE		F 026 003 266	20,6		
	1.7 D	06.94-04.97	42			LLE		0 204 125 467		
	1.7 TD	06.94-08.99	46/51-53			LLE		0 204 125 467		
								0 204 125 474 ^S		
	55 1.1 i.e.	06.94-08.99	40			LLE		0 204 125 467		
								0 204 125 474 ^S		
	60 1.2 i.e.	06.94-08.99	44			LLE		0 204 125 467		
	60 1.2 i.e. Selecta							0 204 125 474 ^S		
	75 1.2 i.e.	06.94-08.99	54			LLE		0 204 125 467		
								0 204 125 474 ^S		
	85 1.2 i.e. 16V	05.97-08.99	63			LLE		0 204 125 467		
								0 204 125 474 ^S		
	90 1.6 i.e.	06.94-04.97	65			LLE		0 204 125 467		
							0 204 125 474 ^S			
	1.7 D, TD	08.93-08.99	42/46/51-53			RLE		0 204 163 104		
	55 1.1 i.e.	08.93-08.99	40			RLE		0 204 163 104		
	60 1.2 i.e., 1.2 i.e. Selecta	08.93-08.99	43/44			RLE		0 204 163 104		
	75 1.2 i.e.	08.93-08.99	54			RLE		0 204 163 104		
	85 1.2 i.e. 16V	05.97-08.99	63			RLE		0 204 163 104		
	90 1.6 i.e.	01.94-04.97	65			RLE		0 204 163 104		
	55 1.1 i.e.	08.93-08.99	40			RLE		F 026 005 587	25,4	
	60 1.2 i.e., 1.2 i.e. Selecta	08.93-08.99	43/44			RLE		F 026 005 587	25,4	
	75 1.2 i.e.	08.93-08.99	54			RLE		F 026 005 587	25,4	
	85 1.2 i.e. 16V	05.97-08.99	63			RLE		F 026 005 587	25,4	
	90 1.6 i.e.	01.94-04.97	65			RLE		F 026 005 587	25,4	
	1.7 D	08.93-04.97	42			LAB		0 204 131 233 ^A		
						RAB		0 204 131 234 ^A		
		ABO	08.93-04.97	42			LAB,LLE		0 986 482 037	
						LLE,RAB		0 986 482 038		
	1.7 TD	08.93-04.97	51			LAB		0 204 131 233 ^A		
						RAB		0 204 131 234 ^A		
			51-53			LAB		0 204 131 233 ^A		
						RAB		0 204 131 234 ^A		
		06.96-04.97	46			LAB		0 204 131 233 ^A		
						RAB		0 204 131 234 ^A		
		05.97-08.99	46			LLE,RAB		0 204 131 234 ^A		
		51			LAB,LLE		0 204 131 233 ^A			
				LLE,RAB		0 204 131 234 ^A				

		S								
1.7 TD	ABO	06.96-04.97	46				LAB,LLE	0 986 482 037		
							LLE,RAB	0 986 482 038		
		05.97-08.97	46				LAB	0 986 482 037		
							RAB	0 986 482 038		
			51				LAB,RLE	0 986 482 037		
							RAB,RLE	0 986 482 038		
ABS	05.97-08.99	46	LAB	0 204 131 233 ^A						
55 1.1 i.e.	ABO	01.95-08.99	40				LAB	0 986 482 037		
							RAB	0 986 482 038		
		08.93-04.97	40				LAB	0 986 482 037		
							RAB	0 986 482 038		
		ABS	08.93-04.97				40	LAB	0 204 131 233 ^A	
								RAB	0 204 131 234 ^A	
60 1.2 i.e.	ABO	06.95-04.97	44				LAB	0 986 482 037		
							RAB	0 986 482 038		
		08.93-05.94	43				LAB	0 986 482 037		
							RAB	0 986 482 038		
		05.97-08.97	44				LAB	0 986 482 037		
							RAB	0 986 482 038		
		ABS	08.93-05.94				43	LAB	0 204 131 233 ^A	
								RAB	0 204 131 234 ^A	
		06.95-03.96	44				LAB	0 204 131 233 ^A		
							RAB	0 204 131 234 ^A		
							LAB	0 204 131 233 ^A		
							RAB	0 204 131 234 ^A		
05.97-08.99	44	LAB	0 204 131 233 ^A							
		RAB	0 204 131 234 ^A							
60 1.2 i.e. Selecta	ABO	06.94-04.97	44				LAB	0 986 482 037		
							RAB	0 986 482 038		
75 1.2 i.e.	ABO	08.93-04.97	54				LAB	0 986 482 037		
							RAB	0 986 482 038		
		05.97-08.97	54				LAB	0 986 482 037		
							RAB	0 986 482 038		
ABS	08.93-03.96	54	LAB				0 204 131 233 ^A			
			RAB				0 204 131 234 ^A			
05.97-08.99	54	LAB	0 204 131 233 ^A							
		RAB	0 204 131 234 ^A							
85 1.2 i.e. 16V	ABO	05.97-08.97	63				LAB	0 986 482 037		
							RAB	0 986 482 038		
		ABS	05.97-08.99	63	LAB	0 204 131 233 ^A				
					RAB	0 204 131 234 ^A				
90 1.6 i.e.	ABO	01.94-04.97	65	LAB	0 986 482 037					
				RAB	0 986 482 038					
		ABS	01.94-04.97	65	LAB	0 204 131 233 ^A				
					RAB	0 204 131 234 ^A				
1.7 D		08.93-03.96	42				0 265 204 014 ^B			
							04.96-04.97	42	0 265 216 418 ^B	
1.7 TD		08.93-03.96	51-53				0 265 204 014 ^B			
							04.96-08.99	51-53	0 265 216 418 ^B	
		06.96-08.99	46				0 265 216 418 ^B			
							08.93-03.96	40	0 265 204 014 ^B	
55 1.1 i.e.		04.96-08.99	40				0 265 216 418 ^B			
							08.93-05.94	43	0 265 204 014 ^B	
60 1.2 i.e.		06.95-03.96	44				0 265 204 014 ^B			
							04.96-08.99	44	0 265 216 418 ^B	
							08.93-03.96	54	0 265 204 014 ^B	
75 1.2 i.e.		04.96-08.99	54				0 265 216 418 ^B			
							05.97-08.99	63	0 265 216 418 ^B	
85 1.2 i.e. 16V		01.94-03.96	65				0 265 204 014 ^B			
90 1.6 i.e.		04.96-04.97	65				0 265 204 014 ^B			
							04.96-04.97	65	0 265 216 418 ^B	















FIAT

Punto [188]



	1.2 Bipower	07.03-12.10	44		JBH,RLE	0 986 481 005	22,2	
		ABS 07.03-12.10	44		AG,JBH,LLE	F 026 003 604	22,2	
					GS,JBH,LLE	F 026 003 603	20,64	
	1.2 i8V	ABO 07.99-06.03	44	Ricam.Nr →0209586, →0697747, →2157164	LLE	0 204 123 532	20,6	
				Ricam.Nr →2653019, →4424965, →5119345	LLE	0 204 123 532	20,6	
				Ricam.Nr 0209587→, 0697748→, 2157165→	LLE	0 204 123 605	20,6	
				Ricam.Nr 2653020→, 4424966→, 5119346→	LLE	0 204 123 605	20,6	
				ABS 07.99-06.03	44	JBH,RLE	0 986 481 005	22,2
				Ricam.Nr →0201866, →0691037, →2649568	LLE	0 204 123 605	20,6	
						LLE	0 204 123 605	20,6
						JBH,LLE	F 026 003 603	20,64
						JBH,LLE	F 026 003 603	20,64
						LLE	0 204 123 532	20,6
						LLE	0 204 123 532	20,6
		1.2 i8V Bipower	ABO 11.02-06.03	59	Ricam.Nr →0209586, →0697747, →2157164	LLE	0 204 123 532	20,6
Ricam.Nr →2653019, →4424965, →5119345					LLE	0 204 123 532	20,6	
Ricam.Nr 0209587→, 0697748→, 2157165→					LLE	0 204 123 605	20,6	
Ricam.Nr 2653020→, 4424966→, 5119346→					LLE	0 204 123 605	20,6	
ABS 11.02-06.03					59	JBH,RLE	0 986 481 005	22,2
Ricam.Nr →0201866, →0691037, →2649568					LLE	0 204 123 605	20,6	
						LLE	0 204 123 605	20,6
						JBH,LLE	F 026 003 603	20,64
						JBH,LLE	F 026 003 603	20,64
						LLE	0 204 123 605	20,6
						LLE	0 204 123 605	20,6
		1.2 i16V	ABO 07.99-06.03	59		AG,JBH,RLE	0 986 481 005	22,2
	Ricam.Nr →0209586, →0697747, →2157164				AG,LLE	0 204 123 533	22,2	
					GS,LLE	0 204 123 532	20,6	
	Ricam.Nr →2653019, →4424965, →5119345				AG,LLE	0 204 123 533	22,2	
					GS,LLE	0 204 123 532	20,6	
	Ricam.Nr 0209587→, 0697748→, 2157165→				AG,LLE	0 204 123 606	22,2	
					GS,LLE	0 204 123 605	20,6	
	Ricam.Nr 2653020→, 4424966→, 5119346→				AG,LLE	0 204 123 606	22,2	
					GS,LLE	0 204 123 605	20,6	
	ABS 07.99-06.03	59	JBH,RLE	0 986 481 005	22,2			
						AG,LLE	0 204 123 533	22,2
						GS,LLE	0 204 123 605	20,6
						AG,LLE	0 204 123 533	22,2
						GS,LLE	0 204 123 605	20,6
						AG,JBH,	F 026 003 604	22,2
						LLE		
						GS,JBH,	F 026 003 603	20,64
						LLE		
					AG,JBH,	F 026 003 604	22,2	
					LLE			
					GS,JBH,	F 026 003 603	20,64	
					LLE			



										
1.2 i.e. 8V		07.03-12.10	44			JBH,RLE	0 986 481 005	22,2		
	ABO	07.03-12.10	44			LLE	0 204 123 605	20,6		
	ABS	07.03-12.10	44			JBH,LLE	F 026 003 603	20,64		
1.2 i.e. 16V		07.03-12.10	59			JBH,RLE	0 986 481 005	22,2		
	ABO	07.03-12.10	59			LLE	0 204 123 605	20,6		
	ABS	07.03-12.10	59			AG,JBH,LLE	F 026 003 604	22,2		
1.2 LPG		08.07-12.10	44			AG,JBH,LLE	F 026 003 604	22,2		
	ABO	08.07-12.10	44			GS,LLE	0 204 123 605	20,6		
	ABS	08.07-12.10	44			GS,JBH,LLE	F 026 003 603	20,64		
	OFD	08.07-12.10	44			JBH,RLE	0 986 481 005	22,2		
1.3 MJTD 16V	ABO	07.03-12.10	52			LLE	0 204 123 605	20,6		
	ABS, OFD	07.03-12.10	52			JBH,LLE	F 026 003 604	22,2		
	MFD	07.03-12.10	52			JBH,LLE	F 026 003 628	22,2		
	OFD	07.03-12.10	52			JBH,RLE	0 986 481 005	22,2		
1.4 i.e. 16V	ABS, OFD	07.03-12.10	70			JBH,LLE	F 026 003 604	22,2		
	MFD	07.03-12.10	70			JBH,LLE	F 026 003 628	22,2		
	OFD	07.03-12.10	70			JBH,RLE	0 986 481 005	22,2		
1.8 i 16V		07.99-06.03	96			JBH,RLE	0 986 481 005	22,2		
					Ricam.Nr →0201866, →0691037, →2649568	LLE	0 204 123 606	22,2		
					Ricam.Nr →4418627, →5114354, →2153486	LLE	0 204 123 606	22,2		
					Ricam.Nr 0209587→, 0697748→, 2157165→	JBH,LLE	F 026 003 604	22,2		
					Ricam.Nr 2653020→, 4424966→, 5119346→	JBH,LLE	F 026 003 604	22,2		
1.8 i.e. 16V		07.03-12.10	96			JBH,LLE	F 026 003 628	22,2		
1.9 D		07.99-06.03	44/59			JBH,RLE	0 986 481 005	22,2		
1.9 JTD	ABO	07.99-06.03	44/59			LLE	0 204 123 606	22,2		
	ABS	07.99-06.03	44/59/63		Ricam.Nr →0201866, →0691037, →2649568	LLE	0 204 123 606	22,2		
					Ricam.Nr →4418627, →5114354, →2153486	LLE	0 204 123 606	22,2		
					Ricam.Nr 0209587→, 0697748→, 2157165→	JBH,LLE	F 026 003 604	22,2		
					Ricam.Nr 2653020→, 4424966→, 5119346→	JBH,LLE	F 026 003 604	22,2		
1.9 JTD		06.01-06.03	63			JBH,RLE	0 986 481 005	22,2		
	ABO	06.01-06.03	63			LLE	0 204 123 606	22,2		
1.9 JTD 8V		07.03-12.10	74			JBH,LLE	F 026 003 628	22,2		
	ABO	07.03-12.10	63			LLE	0 204 123 605	20,6		
	ABS, OFD	07.03-12.10	63			JBH,LLE	F 026 003 604	22,2		
	MFD	07.03-12.10	63			JBH,LLE	F 026 003 628	22,2		
	OFD	07.03-12.10	63			JBH,RLE	0 986 481 005	22,2		
 1.2 Bipower, i 8V, i 8V Bipower, i 16V, i.e. 8V, i.e. 16V, LPG		07.99-12.10	44/59			LLE	0 204 125 731			
	1.3 MJTD 16V	07.03-12.10	52			LLE	0 204 125 731			
	1.4 i.e. 16V	07.03-12.10	70			LLE	0 204 125 731			
	1.8 i 16V, i.e. 16V	07.99-12.10	96			LLE	0 204 125 731			
	1.9 D, JTD, JTD 8V	07.99-12.10	44/59/63/74			LLE	0 204 125 731			
 1.2 Bipower, i 8V, i.e. 8V, LPG		07.99-12.10	44			LLE	0 986 486 073	15,87		
	1.2 i 8V Bipower	11.02-06.03	59			LLE	0 986 486 073	15,87		
	1.2 i 16V	07.99-06.03	59			LLE	0 986 486 077	15,87		
	1.2 i.e. 16V		07.03-10.03	59			LLE	0 986 486 077	15,87	
			11.03-12.10	59			LLE	0 986 486 092	15,87	
	1.3 MJTD 16V		07.03-10.03	52			LLE	0 986 486 077	15,87	
		11.03-12.10	52			LLE	0 986 486 092	15,87		



		S							
◀ FIAT Punto [188]									
	1.4 i.e. 16V	07.03-12.10	70			LLE	0 986 486 073	15,87	
	1.8 i 16V, i.e. 16V	07.99-12.10	96			LLE	0 986 486 073	15,87	
	1.9 D, JTD	07.99-06.03	44/59			LLE	0 986 486 077	15,87	
	1.9 JTD	06.01-06.03	63/74			LLE	0 986 486 077	15,87	
	1.9 JTD 8V	07.03-10.03	63/74			LLE	0 986 486 077	15,87	
		11.03-12.10	63/74			LLE	0 986 486 092	15,87	
	1.2 Bipower	07.03-12.10	44				0 986 486 597	20,64	
	1.2 i 8V	07.99-07.02	44			LLE	0 986 486 597	20,64	
		07.99-06.03	44			RLE	0 986 486 563	20,6	
	1.2 i 8V Bipower	11.02-06.03	59			RLE	0 986 486 563	20,6	
	1.2 i 16V, i.e. 16V	07.99-12.10	59				0 986 486 563	20,6	
	1.2 i.e. 8V	07.03-12.10	44				0 986 486 597	20,64	
	1.2 LPG	08.07-12.10	44			LLE	0 986 486 597	20,64	
	1.3 MJTD 16V	07.03-12.10	52				0 986 486 556	20,6	
	1.4 i.e. 16V	07.03-12.10	70			LLE	0 986 486 597	20,64	
						RLE	0 986 486 563	20,6	
	1.8 i 16V, i.e. 16V	07.99-12.10	96			RLE	0 986 486 556	20,6	
	1.9 D, JTD, JTD 8V	07.99-12.10	44/59/63				0 986 486 556	20,6	
	1.2 Bipower, i.e. 8V	ABO 07.03-12.10	44				0 204 031 180 ^A		
	1.2 i 16V	07.99-06.03	59			AG	0 204 031 180 ^A		
	1.2 i.e. 16V	ABO 07.03-12.10	59				0 204 031 180 ^A		
	1.3 MJTD 16V	ABO 07.03-12.10	52				0 204 031 180 ^A		
	1.9 D, JTD	07.99-06.03	44/59				0 204 031 180 ^A		
	1.9 JTD	06.01-06.03	63				0 204 031 180 ^A		
	1.9 JTD 8V	ABO 07.03-12.10	63				0 204 031 180 ^A		
	1.2 Bipower, i.e. 8V	07.03-12.10	44				0 265 231 332 ^B		
	1.2 i 8V	07.99-05.02	44			Ricam.Nr →284749, →4546420, →5171879	0 265 216 619 ^B		
		06.02-06.03	44			Ricam.Nr 284750→, 4546421→, 5171880→	0 265 216 946 ^F		
	1.2 i 8V Bipower	11.02-06.03	59				0 265 216 946 ^F		
	1.2 i 16V	07.99-05.02	59			Ricam.Nr →284749, →4546420, →5171879	0 265 216 623 ^B		
						AG	0 265 216 619 ^B		
		06.02-06.03	59			Ricam.Nr 284750→, 4546421→, 5171880→	0 265 216 944 ^F		
						AG	0 265 216 946 ^F		
						GS	0 265 216 946 ^F		
	1.2 i.e. 16V	07.03-12.10	59				0 265 231 332 ^B		
	1.2 LPG	08.07-12.10	44				0 265 231 332 ^B		
							0 265 234 007 ^T		
	1.3 MJTD 16V	07.03-12.10	52				0 265 231 332 ^B		
							0 265 234 007 ^T		
	1.4 i.e. 16V	07.03-12.10	70				0 265 231 366 ^B		
							0 265 234 007 ^T		
	1.8 i 16V	07.99-06.03	96				0 265 220 553 ^B		
	1.8 i.e. 16V	07.03-12.10	96				0 265 234 007 ^T		
	1.9 D	07.99-05.02	44/59			Ricam.Nr →284749, →4546520, →5171879	0 265 216 623 ^B		
	1.9 JTD	06.02-06.03	44/59			Ricam.Nr 284750→, 4546421→, 5171880→	0 265 216 946 ^F		
	1.9 JTD	06.01-05.02	63			Ricam.Nr →284749, →4546520, →5171879	0 265 216 623 ^B		
		06.02-06.03	63			Ricam.Nr 284750→, 4546421→, 5171880→	0 265 216 946 ^F		
	1.9 JTD 8V	07.03-12.10	63				0 265 231 332 ^B		
							0 265 234 007 ^T		
			74				0 265 234 007 ^T		
	1.2 LPG	08.07-12.10	44				0 265 005 241		
	1.3 MJTD 16V	07.03-12.10	52				0 265 005 241		
	1.4 i.e. 16V	07.03-12.10	70				0 265 005 241		
	1.8 i.e. 16V	07.03-12.10	96				0 265 005 241		
	1.9 JTD 8V	07.03-12.10	63/74				0 265 005 241		



Punto [199]



	0.9	03.12→	57-62,5/74	LLE,SSG	0 204 123 682	22,2	
		MFD	03.12→	57-62,5/74	RLE	0 204 123 686	22,2
		OFD	03.12→	57-62,5/74	RLE	0 204 123 685	22,2
0,9	11.13→	72-77	LLE,SSG	0 204 123 682	22,2		
	MFD	11.13→	72-77	RLE	0 204 123 686	22,2	
	OFD	11.13→	72-77	RLE	0 204 123 685	22,2	
1.2	01.12→	48/49/51	LLE,SSG	0 204 123 682	22,2		
	MFD	01.12→	48/49/51	RLE	0 204 123 686	22,2	
	OFD	01.12→	48/49/51	RLE	0 204 123 685	22,2	
1.3 Miltijet	01.12→	55/59/62/70	LLE,SSG	0 204 123 682	22,2		
1.3 Multijet	MFD	01.12→	55/59/62/70	RLE	0 204 123 686	22,2	
	OFD	01.12→	55/59/62/70	RLE	0 204 123 685	22,2	
1.4	01.12→	51-57/77/99	LLE,SSG	0 204 123 682	22,2		
1.4 LPG	MFD	01.12→	51-57/77/99	RLE	0 204 123 686	22,2	
1.4 Natural Power	OFD	01.12→	51-57/77/99	RLE	0 204 123 685	22,2	
1.4 Abarth, Abarth SS	01.12→	120/132	RLE	0 204 123 687	23,81		

	0.9	03.12→	57-62,5/74	BSS,RLE	0 204 777 286	
				BSS,LLE	0 204 125 916	
				BSS,RLE	0 204 125 852	
0,9	11.13→	72-77	BSS,RLE	0 204 777 286		
			BSS,LLE	0 204 125 916		
			BSS,RLE	0 204 125 852		
1.2	01.12→	48/49/51	BSS,RLE	0 204 777 286		
			BSS,LLE	0 204 125 916		
			BSS,RLE	0 204 125 852		
1.3 Miltijet	01.12→	55/59/62/70	BSS,RLE	0 204 777 286		
1.3 Multijet	01.12→	70	BSS,LLE	0 204 125 916		
			BSS,RLE	0 204 125 852		
1.4	01.12→	51-57/77/99	BSS,RLE	0 204 777 286		
1.4 LPG	01.12→	99	BSS,LLE	0 204 125 916		
1.4 Natural Power	01.12→	99	BSS,RLE	0 204 125 852		
1.4 Abarth	01.12→	120/132	LLE	0 204 125 917		
1.4 Abarth SS	01.12→	120/132	RLE	0 204 125 853		

















	1.3 Miltijet	01.12→	59/62		0 986 486 556	20,6
				SSG	0 986 486 589	34
	1.3 Multijet	01.12→	55		0 986 486 556	20,6
					0 986 486 589	34
					0 986 486 556	20,6
		70		0 986 486 589	34	

	0.9	03.12→	57-62,5/74		0 265 232 653^B	
	0,9	11.13→	72-77		0 265 232 653^B	
	1.2	01.12→	48/49/51		0 265 232 653^B	
	1.3 Miltijet, Multijet	01.12→	55/59/62/70		0 265 232 653^B	
	1.4 , LPG, Natural Power	01.12→	51-57/77/99		0 265 232 653^B	

	0.9	03.12→	57-62,5/74		0 265 005 823	
	0,9	11.13→	72-77		0 265 005 823	
	1.2	01.12→	48/49/51		0 265 005 823	
	1.3 Miltijet, Multijet	01.12→	55/59/62/70		0 265 005 823	
	1.4 , Abarth, Abarth SS, LPG, Natural Power	01.12→	51-57/77/99/120/132		0 265 005 823	



			S																
◀ FIAT																			
Quobo [300..]																			
	1.3 Multijet		09.08→	55		LLE,TW		0 204 123 767	22,2										
								0 204 123 784	22,2										
								09.10→	70	LLE,TW	0 204 123 767	22,2							
											0 204 123 784	22,2							
								03.15→	59	LLE	0 204 123 784	22,2							
											RLE,TW	0 204 123 685	22,2						
								70	LLE	0 204 123 784	22,2								
										RLE,TW	0 204 123 685	22,2							
								MFD 09.08→	55	RLE	0 204 123 686	22,2							
											09.10→	70	RLE	0 204 123 686	22,2				
								OFD 09.08→	55	RLE	0 204 123 685	22,2							
											09.10→	70	RLE	0 204 123 685	22,2				
								1.4	09.08→	51-57	LLE,TW	0 204 123 767	22,2						
												0 204 123 784	22,2						
1.4 Natural Power	MFD 09.08→	51-57	RLE	0 204 123 686	22,2														
				OFD 09.08→	51-57	RLE	0 204 123 685	22,2											
	1.3 Multijet	09.08→	55/59/70		BSS,LLE	0 204 749 601													
						BSS,RLE	0 204 777 286												
						BSS,LLE	0 204 125 900												
						BSS,RLE	0 204 125 852												
						1.4	09.08→	51-57	BSS,LLE	0 204 749 601									
										BSS,RLE	0 204 777 286								
1.4 Natural Power			BSS,LLE	0 204 125 900															
				BSS,RLE	0 204 125 852														
	1.3 Multijet	09.08→	55/70			0 986 486 556	20,6												
	1.3 Multijet	06.10→	55			0 265 232 831 ^B													
						09.10→	59/70	0 265 232 831 ^B											
						1.4, Natural Power	09.10→	51-57	0 265 232 831 ^B										
	1.3 Multijet	09.08→	55/70			0 265 005 823													
						1.4, Natural Power	09.08→	51-57	0 265 005 823										
Quobo [300]																			
	1.4		09.14→	54-57				0 265 005 823											
Scudo [222..]																			
	1.6 i	ABO	10.95-05.99	58	Ricom.Nr →8211	JBH,RLE		F 026 003 166	23,8										
								06.99-05.00	58	Ricom.Nr 8212→	JBH,RLE	F 026 003 517	23,81						
								ABS	10.95-05.99	58	Ricom.Nr →8211	JBH,LLE	F 026 003 518	22,2					
													RLE	0 204 123 182	23,8				
								06.99-05.00	58	Ricom.Nr 8212→	JBH,RLE	F 026 003 516	23,81						
												1.9 D	ABO	10.95-05.99	51	Ricom.Nr →8211	JBH,RLE	F 026 003 166	23,8
								06.99-08.01	51	Ricom.Nr 8212→	JBH,RLE							F 026 003 517	23,81
								09.01-05.04	52	Ricom.Nr 8212→	JBH,RLE							F 026 003 517	23,81
								06.04-01.07	51		JBH,L09							F 026 003 517	23,81
								ABS	10.95-05.99	51	Ricom.Nr →8211	JBH,LLE	F 026 003 518	22,2					
													RLE	0 204 123 182	23,8				

		S							
1.9 D	ABS	06.99-08.01	51	Ricam.Nr 8212→	JBH,RLE	F 026 003 516	23,81		
		09.01-05.04	52	Ricam.Nr 8212→	JBH,RLE	F 026 003 516	23,81		
		06.04-01.07	51		JBH,L09	F 026 003 516	23,81		
1.9 TD	ABO	10.95-05.99	68	Ricam.Nr →8211	JBH	F 026 003 166	23,8		
		03.97-05.99	66	Ricam.Nr →8211	JBH,RLE	F 026 003 166	23,8		
		06.99-05.00	66	Ricam.Nr 8212→	JBH,RLE	F 026 003 517	23,81		
	ABS	68	Ricam.Nr 8212→	JBH,L09	F 026 003 517	23,81			
		10.95-05.99	68	Ricam.Nr →8211		0 204 123 182	23,8		
					JBH,L01,LLE	F 026 003 518	22,2		
		03.97-05.99	66	Ricam.Nr →8211	JBH,LLE	F 026 003 518	22,2		
			RLE	0 204 123 182	23,8				
	06.99-05.00	66	Ricam.Nr 8212→	JBH,RLE	F 026 003 516	23,81			
	68	Ricam.Nr 8212→	JBH,L09	F 026 003 516	23,81				
2.0 16V	ABO	10.99-05.04	70/81/100	Ricam.Nr 8212→	JBH	F 026 003 517	23,81		
2.0 16V JTD		06.04-01.07	70/81/100		JBH	F 026 003 517	23,81		
2.0 8V JTD	ABS	10.99-05.04	70/81/100	Ricam.Nr 8212→	JBH	F 026 003 516	23,81		
		06.04-01.07	70/81/100		JBH	F 026 003 516	23,81		
	1.9 D	06.98-01.07	51/52		L09,LLE	0 204 125 715			
	1.9 TD	10.95-05.00	68		FCC,L09,LLE	0 204 125 715			
	2.0 16V	05.00-01.07	100		LLE	0 204 125 715			
	2.0 16V JTD	09.00-01.07	81		LLE	0 204 125 715			
	2.0 8V JTD	10.99-05.04	81		LLE	0 204 125 715			
		10.99-01.07	70		FCC,LLE	0 204 125 715			
	06.04-01.07	81		FCC,LLE	0 204 125 715				
	1.6 i	10.95-05.00	58			0 204 131 085^A			
	1.9 D, TD	10.95-01.07	51/52/66/68			0 204 131 085^A			
	2.0 16V, 16V JTD, 8V JTD	10.99-01.07	70/81/100			0 204 131 085^A			
	1.6 i	06.97-12.99	58	Ricam.Nr 7480→8420		0 265 216 496^B			
	1.9 D, TD	06.97-12.99	51/66/68	Ricam.Nr 7480→8420		0 265 216 496^B			
	2.0 8V JTD	10.99-12.99	70/81	Ricam.Nr 7480→8420		0 265 216 496^B			
Scudo [270]									
									
	1.6 Multijet	03.12→	66			0 265 005 765			
Scudo [272..]									
									
	1.6 Multijet	12.07-06.08	66	Ricam.Nr →11557		0 265 005 724			
		07.08→	66	Ricam.Nr 11558→		0 265 005 765			
	2.0 Multijet	12.07-06.08	88	Ricam.Nr →11557		0 265 005 724			
			100/120	Ricam.Nr →11557		0 265 005 724			
		07.08→	88	Ricam.Nr 11558→		0 265 005 765			
			100/120	Ricam.Nr 11558→		0 265 005 765			
		10.08→	88			0 265 005 765			
04.11→	94			0 265 005 765					
Sedici [189]									
									
	1.6, 4x4	MFD 05.06→	79/88			0 986 481 066	22,2		
	1.9 JTD, JTD 4x4	MFD 05.06-09.09	88			0 986 481 066	22,2		
	2.0 JTD, JTD 4x4	MFD 08.09→	99		RLE	0 986 481 066	22,2		



FIAT

Seicento [187..]



	Elettra	10.98-12.03		JBH	F 026 003 430	19,05
	900	03.98-12.03	29	JBH	F 026 003 430	19,05
	1100	03.98-12.10	40	JBH	F 026 003 430	19,05
	Elettra	10.98-12.03			0 204 125 450	
	900	03.98-12.03	29		0 204 125 450	
	1100	03.98-12.10	40		0 204 125 450	
	Elettra	ABO 10.98-12.03		ZE	0 204 131 720	
	900	ABO 03.98-12.03	29	ZE	0 204 131 720	
		ABS 03.98-12.03	29	LAB	0 204 131 233^A	
	1100	ABO 03.98-12.10	40	RAB	0 204 131 234^A	
		ABS 03.98-12.10	40	ZE	0 204 131 720	
	1100	ABO 03.98-12.10	40	LAB	0 204 131 233^A	
ABS 03.98-12.10		40	RAB	0 204 131 234^A		
	900	03.98-12.03	29	Ricam.Nr →0698291	0 265 216 570^B	
				Ricam.Nr 0698292→	0 265 216 711^B	
1100	03.98-12.10	40	Ricam.Nr →0698291	0 265 216 570^B		
			Ricam.Nr 0698292→	0 265 216 711^B		
	900	03.98-12.03	29		1 273 004 426^H	
	1100	03.98-12.10	40		1 273 004 426^H	

Siena

























	1.3 MPI 16V	01.04-12.07	59	WBH	0 204 032 601	
	1.3 MPI 16V	ABO 01.04-12.07	59	JBH	ATE 0 986 481 020	22,2
					BSY	0 204 032 609
1.3 MPI 16V				WBH	BSY 0 204 032 301	22,22
	1.3 MPI 16V	ABO 01.04-12.07	59		BSY 0 204 032 348	
				225	BSY 0 204 032 622	
	1.3 MPI 16V	01.04-12.07	59		0 265 216 572^B	

Siena [Fase I]



	1.0 MPI 16V	ABO 03.00-02.03	52	JBH	ATE 0 986 481 020	22,2
	1.3 MPI 16V	03.00-02.03	59	WBH	0 204 032 601	
		ABO 03.00-02.03	59	JBH	ATE 0 986 481 020	22,2
1.3 MPI 16V				BSY	0 204 032 609	
				WBH	BSY 0 204 032 301	22,22
	1.3 MPI 16V	ABO 03.00-02.03	59		BSY 0 204 032 348	
	1.0 MPI 16V	03.00-02.03	52		0 265 216 828^B	
	1.3 MPI 16V	03.00-09.00	59		0 265 216 550^B	
		10.00-02.03	59		0 265 216 828^B	

									
Siena [172..]									
									
	1.2 i.e. 8V	ABS	01.02-03.04	44			0 204 123 524	22,22	
	1.6 i.e. 16V	ABS	01.02-03.04	76			0 204 123 524	22,22	
	1.2 i.e. 8V	ABS	01.02-03.04	44			0 204 125 728		
	1.6 i.e. 16V	ABS	01.02-03.04	76			0 204 125 728		
	1.2 i.e. 8V		01.02-03.04	44			F 009 D00 769		
	1.6 i.e. 16V		01.02-03.04	76			F 009 D00 769		
	1.2 i.e. 8V		01.02-03.04	44			0 265 216 572 ^B		
	1.6 i.e. 16V		01.02-03.04	76			0 265 216 572 ^B		
Siena [178..]									
									
	1.2 i.e. 8V		01.00-12.01	54			0 204 123 524	22,22	
		ABO	04.98-07.00	44	Fg.-Nr. 582136→	JBH	0 986 481 020	22,2	
			05.99-12.01	44			0 204 123 524	22,22	
			08.00-06.01	44		JBH ATE	0 986 481 020	22,2	
			03.01-10.01	44		JBH	0 986 481 020	22,2	
			07.01-12.01	44		JBH BSY	0 204 032 609		
						WBH BSY	0 204 032 301	22,22	
	1.4 i.e.	ABO	04.97-02.99	51	Fg.-Nr. 0582136→	JBH	0 986 481 020	22,2	
			08.00-06.01	51		JBH ATE	0 986 481 020	22,2	
	1.6 i.e. 16V	ABO	04.97-10.99	76	Fg.-Nr. 0582136→	JBH	0 986 481 020	22,2	
			05.98-10.99	76		JBH	0 986 481 020	22,2	
			08.00-12.01	76		JBH ATE	0 986 481 020	22,2	
			01.01-12.01	76			0 204 123 524	22,22	
	1.7 TD		05.99-12.01	46/47			0 204 123 524	22,22	
	1.2 i.e. 8V		01.00-12.01	54			0 204 125 728		
		ABO	05.99-12.01	44			0 204 125 728		
			07.01-12.01	44		BSY	0 204 032 348		
	1.6 i.e. 16V	ABO	01.01-12.01	76			0 204 125 728		
	1.7 TD		05.99-12.01	46/47			0 204 125 728		
	1.2 i.e. 8V		05.99-12.01	44			F 009 D00 769		
			01.00-12.01	54		RLE	F 009 D00 769		
	1.6 i.e. 16V		01.01-12.01	76			F 009 D00 769		
	1.7 TD		05.99-12.01	46/47			F 009 D00 769		
	1.2 i.e. 8V		05.99-05.00	44			F 026 005 581	25,4	
			01.00-12.01	54		RLE	F 026 005 581	25,4	
	1.6 i.e. 16V		01.01-12.01	76			F 026 005 581	25,4	
	1.7 TD		05.99-05.00	46			F 026 005 581	25,4	
	1.2 i.e. 8V		03.99-12.01	44/54			0 265 216 550 ^B		
	1.4 i.e.		04.97-06.01	51			0 265 216 550 ^B		
	1.6 i.e. 16V		04.97-12.01	76			0 265 216 550 ^B		
	1.7 TD		05.99-12.01	46/47			0 265 216 550 ^B		
Stilo									
									
	1.8 MPI 8V		06.02-12.07	76/97			0 204 0C2 335		
	1.8 MPI 16V								



◀ FIAT Stilo									
	1.8 MPI 8V		06.02-09.05	76				0 265 224 094 ^B	
								0 265 225 233 ^T	
	1.8 MPI 16V		01.04-12.07	97				0 265 224 094 ^B	
	1.9 JTD		06.02-12.07	85				0 265 224 094 ^B	
	2.4 MPI 20V		06.02-12.08	123				0 265 225 233 ^T	
	2.4 MPI 20V		06.02-12.08	123				0 265 005 241	
	Stilo Multi Wagon [192..]								
	1.4 16V		01.04-12.07	66/70				0 204 123 625	22,2
	1.6 16V	MFD	10.02-12.07	76/77				0 204 123 587	22,2
		OFD	10.02-12.07	76	Ricam.Nr →367397			0 204 123 586	22,2
					Ricam.Nr 0367398→			0 204 123 625	22,2
			07.05-12.07	77				0 204 123 625	22,2
	1.6 16V Natural Power		04.06-12.07	76				0 204 123 625	22,2
	1.8 16V		10.02-12.07	98	Ricam.Nr 500748→	JBH		F 026 003 641	23,81
		MFD	10.02-12.07	98	Ricam.Nr →500747	JBH		F 026 003 588	23,81
		OFD	10.02-12.07	98	Ricam.Nr →367397			0 204 123 625	22,2
					Ricam.Nr 0367398→500747	JBH		F 026 003 641	23,81
	1.9 JTD 8V		09.04-12.07	74				0 204 123 625	22,2
		MFD	10.02-12.07	59/66/85/88				0 204 123 587	22,2
		OFD	10.02-12.07	59	Ricam.Nr →367397	AAD		0 204 123 625	22,2
						ADP		0 204 123 586	22,2
					Ricam.Nr 0367398→			0 204 123 625	22,2
				85	Ricam.Nr →367397	AAD		0 204 123 625	22,2
						ADP		0 204 123 586	22,2
					Ricam.Nr 0367398→			0 204 123 625	22,2
			07.05-12.07	85				0 204 123 625	22,2
				88				0 204 123 625	22,2
			10.05-12.07	66				0 204 123 625	22,2
	1.9 JTD 16V		01.04-12.07	93/100/103	Ricam.Nr 500748→	JBH		F 026 003 641	23,81
			12.06-12.07	110		JBH		F 026 003 641	23,81
		MFD	01.04-12.07	93/100/103	Ricam.Nr →500747	JBH		F 026 003 588	23,81
			07.05-11.06	110		JBH		F 026 003 588	23,81
		OFD	01.04-12.07	93/100/103	Ricam.Nr →500747	JBH		F 026 003 641	23,81
			07.05-11.06	110		JBH		F 026 003 641	23,81
	2.4 20V		01.04-12.07	125		JBH		F 026 003 588	23,81
	1.4 16V		01.04-12.07	66/70				0 204 125 833	
	1.6 16V		10.02-12.07	76	Ricam.Nr 0367398→			0 204 125 833	
			07.05-12.07	77				0 204 125 833	
		MFD	10.02-12.07	76	Ricam.Nr →367397			0 204 125 784	
		OFD	10.02-12.07	76	Ricam.Nr →367397			0 204 125 783	
	1.6 16V Natural Power		04.06-12.07	76				0 204 125 833	
	1.8 16V		10.02-12.07	98	Ricam.Nr 0367398→			0 204 125 834	
		MFD	10.02-12.07	98	Ricam.Nr →367397			0 204 125 785	
		OFD	10.02-12.07	98	Ricam.Nr →367397			0 204 125 784	
	1.9 JTD 8V		10.02-12.07	59	Ricam.Nr 0367398→			0 204 125 833	
				85	Ricam.Nr 0367398→			0 204 125 833	
			09.04-12.07	66/74				0 204 125 833	
			07.05-12.07	85				0 204 125 833	
		MFD	10.02-12.07	59	Ricam.Nr →367397			0 204 125 784	
				85	Ricam.Nr →367397			0 204 125 784	
		OFD	10.02-12.07	59	Ricam.Nr →367397	AAD		0 204 125 784	
						ADP		0 204 125 783	
				85	Ricam.Nr →367397	AAD		0 204 125 784	
						ADP		0 204 125 783	
	1.9 JTD 16V		01.04-12.07	93/100/103/110				0 204 125 834	
	2.4 20V		01.04-12.07	125				0 204 125 834	

		S							
	1.4 16V	01.04-12.07	66/70			LLE	0 986 486 107	15,8	
	1.8 16V	10.02-12.07	98			LLE	0 986 486 107	15,8	
	1.9 JTD 8V	10.02-12.07	59/74/85			LLE	0 986 486 107	15,8	
	1.9 JTD 16V	01.04-12.07	93/100/103/110			LLE	0 986 486 140	15,87	
	2.4 20V	01.04-12.07	125			LLE	0 986 486 140	15,87	
	1.4 16V	01.04-12.07	66/70				0 986 486 563	20,6	
	1.6 16V	10.02-12.07	76/77			RLE	0 986 486 563	20,6	
	1.9 JTD 8V	10.02-12.07	59/74				0 986 486 556	20,6	
	1.4 16V	01.04-12.07	66/70				0 265 231 807 ^B		
	1.6 16V	07.05-11.06	77	Ricam.Nr 578471→			0 265 234 353 ^T		
		07.05-12.07	77				0 265 231 807 ^B		
				Ricam.Nr →578470			0 265 234 021 ^T		
	1.6 16V	10.02-11.06	76	Ricam.Nr 578471→			0 265 234 353 ^T		
	1.6 16V Natural Power	10.02-12.07	76				0 265 231 807 ^B		
					Ricam.Nr →00294783		0 265 225 092 ^T		
					Ricam.Nr 00294784→0367397		0 265 225 233 ^T		
					Ricam.Nr 0367398→578470		0 265 234 021 ^T		
	1.8 16V	10.02-11.06	98	Ricam.Nr 578471→			0 265 234 353 ^T		
		10.02-12.07	98				0 265 231 807 ^B		
					Ricam.Nr →00294783		0 265 225 092 ^T		
					Ricam.Nr 00294784→0367397		0 265 225 233 ^T		
				Ricam.Nr 0367398→578470			0 265 234 021 ^T		
	1.9 JTD 8V	10.02-11.06	59	Ricam.Nr 578471→			0 265 234 353 ^T		
			85	Ricam.Nr 578471→			0 265 234 353 ^T		
		10.02-12.07	59	Ricam.Nr →00294783			0 265 225 092 ^T		
				Ricam.Nr →0269986			0 265 224 049 ^B		
				Ricam.Nr 00294784→0367397			0 265 225 233 ^T		
				Ricam.Nr 0269987→0367397			0 265 222 035 ^B		
				Ricam.Nr 0367398→			0 265 231 807 ^B		
				Ricam.Nr 0367398→578470			0 265 234 021 ^T		
				Ricam.Nr 597809→			0 265 231 807 ^B		
			85	Ricam.Nr →00294783			0 265 225 092 ^T		
				Ricam.Nr →0269986			0 265 224 049 ^B		
				Ricam.Nr 00294784→0367397			0 265 225 233 ^T		
				Ricam.Nr 0269987→0367397			0 265 222 035 ^B		
			Ricam.Nr 0367398→			0 265 231 807 ^B			
		Ricam.Nr 0367398→578470			0 265 234 021 ^T				
	09.04-11.06	66/74	Ricam.Nr 578471→			0 265 234 353 ^T			
	09.04-12.07	66/74				0 265 231 807 ^B			
			Ricam.Nr →578470			0 265 234 021 ^T			
	07.05-12.07	85				0 265 231 807 ^B			
			Ricam.Nr →578470			0 265 234 021 ^T			
1.9 JTD 8V	01.04-11.06	88/93/100/103/110	Ricam.Nr 578471→			0 265 234 353 ^T			
1.9 JTD 16V	01.04-12.07	88/93/100/103/110				0 265 231 807 ^B			
			Ricam.Nr →578470			0 265 234 021 ^T			
2.4 20V	01.04-11.06	125	Ricam.Nr 578471→			0 265 234 353 ^T			
	01.04-12.07	125				0 265 231 807 ^B			
			Ricam.Nr →578470			0 265 234 021 ^T			
	1.6 16V, 16V Natural Power	10.02-12.07	76/77				0 265 005 241		
	1.8 16V	10.02-12.07	98				0 265 005 241		
	1.9 JTD 8V, JTD 16V	10.02-12.07	59/66/74/85/88/93/100/103/110				0 265 005 241		
	2.4 20V	01.04-12.07	125				0 265 005 241		
	1.6 16V, 16V Natural Power	10.02-12.07	76/77				0 265 005 303		
	1.8 16V	10.02-12.07	98				0 265 005 303		
	1.9 JTD 8V, JTD 16V	10.02-12.07	59/66/74/85/88/93/100/103/110				0 265 005 303		
	2.4 20V	01.04-12.07	125				0 265 005 303		



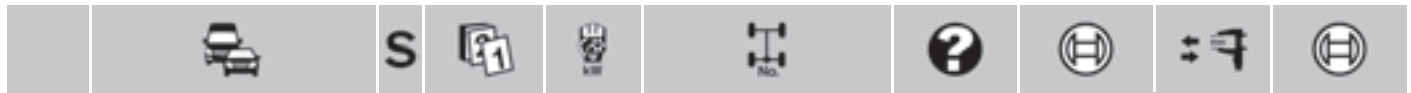

FIAT

Stilo [192..]



	1.2 16V	10.01-12.03	59	Ricam.Nr 0367398→		0 204 123 625	22,2	
		MFD 10.01-12.03	59	Ricam.Nr →367397		0 204 123 587	22,2	
		OFD 10.01-12.03	59	Ricam.Nr →367397	AAD	0 204 123 625	22,2	
					AAP	0 204 123 586	22,2	
	1.4 16V	01.04-12.07	66/70			0 204 123 625	22,2	
	1.6 16V	MFD 10.01-12.03	76	Ricam.Nr →367397		0 204 123 587	22,2	
		01.04-12.07	76			0 204 123 587	22,2	
		07.05-12.07	77			0 204 123 587	22,2	
		OFD 10.01-12.03	76	Ricam.Nr →367397	AAD	0 204 123 625	22,2	
					AAP	0 204 123 586	22,2	
				Ricam.Nr 0367398→		0 204 123 625	22,2	
		01.04-12.07	76			0 204 123 625	22,2	
		07.05-12.07	77			0 204 123 625	22,2	
	1.8 16V	01.04-12.07	98	Ricam.Nr 500748→	JBH	F 026 003 641	23,81	
		MFD 10.01-12.03	98		JBH	F 026 003 588	23,81	
		01.04-12.07	98	Ricam.Nr →500747	JBH	F 026 003 588	23,81	
		OFD 10.01-12.03	98	Ricam.Nr →367397		0 204 123 625	22,2	
				Ricam.Nr 0367398→	JBH	F 026 003 641	23,81	
		01.04-12.07	98	Ricam.Nr →500747	JBH	F 026 003 641	23,81	
	1.9 JTD 8V	01.04-12.07	74			0 204 123 625	22,2	
		MFD 10.01-12.03	59	Ricam.Nr →367397		0 204 123 587	22,2	
			85	Ricam.Nr →367397		0 204 123 587	22,2	
			01.04-12.07	59			0 204 123 587	22,2
			85				0 204 123 587	22,2
			07.05-12.07	88			0 204 123 587	22,2
			10.05-12.07	66			0 204 123 587	22,2
		OFD 10.01-12.03	59	Ricam.Nr →367397	AAD	0 204 123 625	22,2	
					AAP	0 204 123 586	22,2	
				Ricam.Nr 0367398→		0 204 123 625	22,2	
			85	Ricam.Nr →367397	AAD	0 204 123 625	22,2	
					AAP	0 204 123 586	22,2	
				Ricam.Nr 0367398→		0 204 123 625	22,2	
		01.04-12.07	59			0 204 123 625	22,2	
		85				0 204 123 625	22,2	
		07.05-12.07	88			0 204 123 625	22,2	
		10.05-12.07	66			0 204 123 625	22,2	
	1.9 JTD 16V	01.04-12.07	93/100/103	Ricam.Nr 500748→	JBH	F 026 003 641	23,81	
		12.06-12.07	110		JBH	F 026 003 641	23,81	
		MFD 01.04-12.07	93/100/103	Ricam.Nr →500747	JBH	F 026 003 588	23,81	
		07.05-11.06	110		JBH	F 026 003 588	23,81	
		OFD 01.04-12.07	93/100/103	Ricam.Nr →500747	JBH	F 026 003 641	23,81	
		07.05-11.06	110		JBH	F 026 003 641	23,81	
	2.4 20V	10.01-12.03	125		JBH	F 026 003 588	23,81	
		01.04-11.06	125		GS,JBH	F 026 003 588	23,81	
		01.04-12.07	125		AG,JBH	F 026 003 588	23,81	
		12.06-12.07	125		GS,JBH	F 026 003 641	23,81	
	1.2 16V	10.01-12.03	59	Ricam.Nr 0367398→		0 204 125 833		
		MFD 10.01-12.03	59	Ricam.Nr →367397		0 204 125 784		
		OFD 10.01-12.03	59	Ricam.Nr →367397	AAD	0 204 125 784		
				AAP	0 204 125 783			
	1.4 16V	01.04-12.07	66/70			0 204 125 833		
	1.6 16V	10.01-12.03	76	Ricam.Nr 0367398→		0 204 125 833		
		01.04-12.07	76			0 204 125 833		
		07.05-12.07	77			0 204 125 833		
		MFD 10.01-12.03	76	Ricam.Nr →367397		0 204 125 784		
		OFD 10.01-12.03	76	Ricam.Nr →367397	AAD	0 204 125 784		
				AAP	0 204 125 783			

		S								
1.8 16V		10.01-12.03	98	Ricam.Nr 0367398→			0 204 125 834			
		01.04-12.07	98				0 204 125 834			
	MFD	10.01-12.03	98	Ricam.Nr →367397			0 204 125 785			
	OFD	10.01-12.03	98	Ricam.Nr →367397			0 204 125 784			
1.9 JTD 8V		10.01-12.03	59	Ricam.Nr 0367398→			0 204 125 833			
			85	Ricam.Nr 0367398→			0 204 125 833			
		01.04-12.07	59				0 204 125 833			
			66/74				0 204 125 833			
			85				0 204 125 833			
		07.05-12.07	88				0 204 125 833			
	MFD	10.01-12.03	59	Ricam.Nr →367397			0 204 125 784			
			85	Ricam.Nr →367397			0 204 125 784			
	OFD	10.01-12.03	59	Ricam.Nr →367397	AAD		0 204 125 784			
			85	Ricam.Nr →367397	AAP		0 204 125 783			
1.9 JTD 16V		01.04-12.07	93/100/103/110				0 204 125 834			
2.4 20V		10.01-12.03	125	Ricam.Nr →367397			0 204 125 785			
				Ricam.Nr 0367398→			0 204 125 834			
		01.04-12.07	125				0 204 125 834			
	1.2 16V	10.01-12.03	59		LLE		0 986 486 107	15,8		
	1.4 16V	01.04-12.07	66/70		LLE		0 986 486 107	15,8		
	1.8 16V	10.01-12.07	98		LLE		0 986 486 107	15,8		
	1.9 JTD 8V	10.01-12.07	59/74/85		LLE		0 986 486 107	15,8		
	1.9 JTD 16V	01.04-12.07	93/100/103/110		LLE		0 986 486 140	15,87		
	2.4 20V	10.01-12.07	125		LLE		0 986 486 140	15,87		
	1.2 16V	10.01-12.03	59				0 986 486 563	20,6		
	1.4 16V	01.04-12.07	66/70				0 986 486 563	20,6		
	1.6 16V	10.01-12.07	76/77		RLE		0 986 486 563	20,6		
	1.9 JTD 8V	10.01-12.07	59/74				0 986 486 556	20,6		
	1.2 16V	10.01-12.03	59	Ricam.Nr →0269986			0 265 224 049 ^B			
				Ricam.Nr 0269987→0367397			0 265 222 035 ^B			
				Ricam.Nr 367398→			0 265 231 807 ^B			
	1.4 16V	01.04-12.07	66/70				0 265 231 807 ^B			
	1.6 16V	10.01-12.03	76	Ricam.Nr →00294783				0 265 225 092 ^T		
				Ricam.Nr →0269986				0 265 224 049 ^B		
				Ricam.Nr 00294784→0367397				0 265 225 233 ^T		
				Ricam.Nr 0269987→0367397				0 265 222 035 ^B		
				Ricam.Nr 367398→				0 265 231 807 ^B		
								0 265 234 021 ^T		
			01.04-11.06	76	Ricam.Nr 578471→			0 265 234 353 ^T		
		01.04-12.07	76				0 265 231 807 ^B			
				Ricam.Nr →578470				0 265 234 021 ^T		
		07.05-11.06	77	Ricam.Nr 578471→				0 265 234 353 ^T		
		07.05-12.07	77					0 265 231 807 ^B		
				Ricam.Nr →578470				0 265 234 021 ^T		
	1.8 16V	10.01-12.03	98	Ricam.Nr →00294783				0 265 225 092 ^T		
				Ricam.Nr 00294784→0367397				0 265 225 233 ^T		
				Ricam.Nr 367398→				0 265 231 807 ^B		
								0 265 234 021 ^T		
		01.04-11.06	98	Ricam.Nr 578471→			0 265 234 353 ^T			
	01.04-12.07	98				0 265 231 807 ^B				
			Ricam.Nr →578470				0 265 234 021 ^T			
1.9 JTD 8V	10.01-12.03	59	Fg.-Nr. →0270551				0 265 224 049 ^B			
			Fg.-Nr. 0270552→Ricam.Nr 367397				0 265 222 035 ^B			
			Ricam.Nr 367398→				0 265 231 807 ^B			
		85	Ricam.Nr →00294783				0 265 225 092 ^T			
			Ricam.Nr →0269986				0 265 224 049 ^B			
			Ricam.Nr 00294784→0367397				0 265 225 233 ^T			



			S												
◀ FIAT Stilo [192..]															
	1.9 JTD 8V	10.01-12.03	85	Ricam.Nr 0269987→0367397							0 265 222 035 ^B				
				Ricam.Nr 367398→							0 265 231 807 ^B				
											0 265 234 021 ^T				
	01.04-11.06	59	Ricam.Nr 578471→								0 265 234 353 ^T				
			66/74 Ricam.Nr 578471→								0 265 234 353 ^T				
			85 Ricam.Nr 578471→								0 265 234 353 ^T				
	01.04-12.07	59	Ricam.Nr →578470								0 265 231 807 ^B				
			66/74 Ricam.Nr →578470								0 265 234 021 ^T				
		85	Ricam.Nr →578470								0 265 231 807 ^B				
			Ricam.Nr →578470								0 265 234 021 ^T				
			Ricam.Nr →578470								0 265 234 021 ^T				
	1.9 JTD 8V, JTD 16V	01.04-11.06	88/93/100/103/110	Ricam.Nr 578471→								0 265 234 353 ^T			
				01.04-12.07	88/93/100/103/110	Ricam.Nr →578470						0 265 231 807 ^B			
	2.4 20V	10.01-12.03	125	Fg.-Nr. →0270551									0 265 224 049 ^B		
				Fg.-Nr. 0270552→Ricam.Nr 367397									0 265 222 035 ^B		
Ricam.Nr →00294783				0 265 225 092 ^T											
Ricam.Nr 00294784→0367397				0 265 225 233 ^T											
Ricam.Nr 367398→				0 265 231 807 ^B											
				0 265 234 021 ^T											
01.04-11.06 125 Ricam.Nr 578471→				0 265 234 353 ^T											
01.04-12.07	125	Ricam.Nr →578470			0 265 231 807 ^B										
<hr/>															
	1.6 16V	10.01-12.07	76/77								0 265 005 241				
	1.8 16V	10.01-12.07	98								0 265 005 241				
	1.9 JTD 8V, JTD 16V	10.01-12.07	66/74/85/88/93/100/103/110								0 265 005 241				
	2.4 20V	10.01-12.07	125								0 265 005 241				
<hr/>															
	1.6 16V	10.01-12.07	76/77								0 265 005 303				
	1.8 16V	10.01-12.07	98								0 265 005 303				
	1.9 JTD 8V, JTD 16V	10.01-12.07	59/66/74/85/88/93/100/103/110								0 265 005 303				
	2.4 20V	10.01-12.07	125								0 265 005 303				
<hr/>															
Strada															
	1.7 D Turbo	07.99-12.04	52	WBH								0 204 032 601			
				ABO 07.99-12.04 52								JBH	BSY	0 204 032 609	
												WBH	BSY	0 204 032 301	22,22
	1.7 D Turbo	ABO	07.99-12.04	52								BSY 0 204 032 348			
					225 BSY 0 204 032 622										
	1.7 D Turbo	07.99-12.04	52								0 265 216 828 ^B				
<hr/>															
Strada [Fase I]															
	1.5 MPI 8V	10.98-02.03	56	WBH								0 204 032 601			
				ABO 10.98-02.03 56								JBH	ATE	0 986 481 020	22,2
													BSY	0 204 032 609	
	1.5 MPI 8V	ABO	10.98-02.03	56								BSY 0 204 032 348			
					225 BSY 0 204 032 622										
	1.5 MPI 8V	10.98-02.03	56								0 265 216 572 ^B				



Strada [Fase II]















	1.7 D Turbo		01.05-12.08	52		WBH		0 204 032 601	
		ABO	01.05-12.08	52		JBH	ATE	0 986 481 020	22,2
							BSY	0 204 032 609	
						WBH	BSY	0 204 032 301	22,22
	1.7 D Turbo	ABO	01.05-12.08	52			BSY	0 204 032 348	
						225	BSY	0 204 032 622	
	1.7 D Turbo		01.05-12.08	52				0 265 216 828^B	

Strada [278]

	1.2 MPI 8V		03.99-03.05	44/54		WBH		0 204 032 601	
		ABO	03.99-04.03	44		ATN,JBH	BSY	0 204 032 609	
			03.99-03.05	44		ATJ,JBH	BSY	F 026 003 671	22,2
						JBH	ATE	0 986 481 020	22,2
			05.01-03.03	54		JBH	BSY	0 204 032 609	
			05.01-06.05	54		JBH	ATE	0 986 481 020	22,2
	1.3 JTD		07.05-12.11	63		WBH		0 204 032 601	
		ABO	07.05-12.11	63		JBH	ATE	0 986 481 020	22,2
	1.7 TDS		03.99-03.03	51		WBH		0 204 032 601	
		ABO	03.99-03.03	51		JBH	ATE	0 986 481 020	22,2
							BSY	0 204 032 609	
	1.9 D		11.00-03.03	46		WBH		0 204 032 601	
		ABO	11.00-03.03	46		JBH	BSY	0 204 032 609	
			11.00-06.05	46		JBH	ATE	0 986 481 020	22,2
	1.9 JTD	ABO	04.03-06.05	59		JBH	ATE	0 986 481 020	22,2
	1.2 MPI 8V	ABO	03.99-04.03	44	Fg.-Nr. 2724992→	ATN	BSY	0 204 032 622	
			03.99-03.05	44		ATJ	BSY	0 204 125 807	
			05.01-03.03	54	Fg.-Nr. 2724992→		BSY	0 204 032 622	
	1.3 JTD	ABO	07.05-12.11	63		D11	BSY	0 204 032 348	
						225	BSY	0 204 032 622	
	1.7 TDS	ABO	03.99-03.03	51	Fg.-Nr. 2724992→		BSY	0 204 032 622	
	1.9 D	ABO	11.00-03.03	46	Fg.-Nr. 2724992→		BSY	0 204 032 622	
	1.3 JTD		07.05→	63/70				0 986 486 556	20,6
	1.3 Multijet								
	1.2 MPI 8V	ABO	03.99-06.05	44/54				0 204 131 202^A	
	1.3 JTD		07.05-12.11	63				0 204 131 202^A	
	1.7 TDS	ABO	03.99-03.03	51				0 204 131 202^A	
	1.9 D, JTD	ABO	11.00-06.05	46/59				0 204 131 202^A	
	1.2 MPI 8V		03.99-04.03	44				0 265 216 572^B	
			05.01-03.03	54				0 265 216 572^B	
			04.03-06.05	54				0 265 216 828^B	
	1.3 JTD		07.05-12.11	63				0 265 216 828^B	
	1.3 Multijet		12.11→	70	ADV			0 265 232 241^B	
	1.7 TDS		03.99-03.03	51				0 265 216 572^B	
	1.9 D		11.00-03.03	46				0 265 216 572^B	
			04.03-06.05	46				0 265 216 828^B	
	1.9 JTD		04.03-06.05	59				0 265 216 828^B	



		S							
◀ FIAT									
Talento									
	1.9 D	08.89-12.94	51	Fg.-Nr. →0273004, →0169505	JBH		F 026 003 150	22,2	
				Fg.-Nr. 0273005→, 0169506→	JBH		F 026 003 194	22,2	
	2.0	07.90-12.94	55	Fg.-Nr. →0273004, →0169505	JBH		F 026 003 150	22,2	
				Fg.-Nr. 0273005→, 0169506→	JBH		F 026 003 194	22,2	
	1.9 D	09.89-12.94	51	Fg.-Nr. →0169505	LLE	BSY	0 204 125 417		
				Fg.-Nr. →0273004, →0169505			0 204 125 416^S		
				Fg.-Nr. 0273005→, 0169506→			0 204 125 420^S		
							0 204 125 423		
	2.0	07.90-12.94	55	Fg.-Nr. →0169505	LLE	BSY	0 204 125 417		
				Fg.-Nr. →0273004, →0169505			0 204 125 416^S		
				Fg.-Nr. 0273005→, 0169506→			0 204 125 420^S		
							0 204 125 423		
	1.9 D	03.88-12.94	51				0 204 031 056^A		
	2.0	07.90-12.94	55				0 204 031 056^A		
Tempra									
	2.0 SPI 8V	09.95-12.98	81		WBH		0 204 032 301	22,22	
	2.0 SPI 8V	11.92-08.95	71/81		JBH		0 204 032 609		
	2.0 8V	11.92-12.98	71/81		TW,WBH		0 204 032 601		
	2.0 8V	11.92-04.94	71/81		WBH		0 204 032 301	22,22	
	2.0 SPI 8V	09.95-12.98	81				0 204 032 348		
	2.0 8V	11.92-04.94	71				0 204 032 348		
	2.0 SPI 8V	05.94-12.98	81				0 265 208 034^H		
Tempra SW [159]									
	1.4	04.93-12.96	51/56		JBH,LLE		F 026 003 528	22,2	
	1.4 i.e.				RLE		0 204 122 268	22,22	
	1.6, i.e., i.e. Selecta	04.93-12.96	55/62/66		JBH,LLE		F 026 003 528	22,2	
					RLE		0 204 122 268	22,22	
	1.8 i.e.	04.93-12.96	66/71/77		JBH		F 026 003 528	22,2	
	1.9 D	04.93-12.96	48/66		JBH,LLE		F 026 003 528	22,2	
	1.9 TD				RLE		0 204 122 268	22,22	
	2.0 i.e., i.e. 4x4	04.93-12.96	83-85		JBH		F 026 003 528	22,2	
	1.4	04.93-05.94	51/56	Ricam.Nr →7510272	LLE		0 204 125 444		0 204 120 517
	1.4 i.e.	04.93-12.96	51/56		RLE		0 204 125 602^S		
		06.94-12.96	51/56	Ricam.Nr 7510273→	LLE		0 204 125 436		0 204 120 995
	1.6	04.93-05.94	62	Ricam.Nr →7510272	LLE		0 204 125 444		0 204 120 517
		04.93-12.96	62		RLE		0 204 125 602^S		
		06.94-12.96	62	Ricam.Nr 7510273→	LLE		0 204 125 436		0 204 120 995
	1.6 i.e.	04.93-05.94	55		LLE		0 204 125 443^S		
				Ricam.Nr →7510272	LLE		0 204 125 444		0 204 120 517
		04.93-12.96	55		RLE		0 204 125 602^S		
		05.94-12.96	66		LLE		0 204 125 436		0 204 120 995
					RLE		0 204 125 602^S		
		06.94-12.96	55	Ricam.Nr 7510273→	LLE		0 204 125 436		0 204 120 995

		S							
1.6 i.e. Selecta	04.93-12.96	55				LLE	0 204 125 436		0 204 120 995
						RLE	0 204 125 602 ^S		
1.8 i.e.	04.93-05.94	66	Mot.-Nr. →1509143			LLE	0 204 125 443 ^S		
		77	Mot.-Nr. →1509143			LLE	0 204 125 443 ^S		
	04.93-12.96	66	Mot.-Nr. →1509143			LLE	0 204 125 444		0 204 120 517
			Mot.-Nr. 1509144→			LLE	0 204 125 436		
		77				RLE	0 204 125 602 ^S		
			Mot.-Nr. →1509143			LLE	0 204 125 444		0 204 120 517
			Mot.-Nr. 1509144→			LLE	0 204 125 436		
	03.95-12.96	71				RLE	0 204 125 602 ^S		
			Mot.-Nr. →1509143			LLE	0 204 125 444		0 204 120 517
			Mot.-Nr. 1509144→			LLE	0 204 125 436		
1.9D	04.93-05.94	48	Ricam.Nr →7510272			LLE	0 204 125 443 ^S		
							0 204 125 444		0 204 120 517
	04.93-12.96	48				RLE	0 204 125 602 ^S		
	06.94-12.96	48	Ricam.Nr 7510273→			LLE	0 204 125 436		0 204 120 995
1.9TD	04.93-05.94	66	Ricam.Nr →7510272			LLE	0 204 125 443 ^S		
							0 204 125 444		0 204 120 517
	04.93-12.96	66				LLE	0 204 125 436		0 204 120 995
						RLE	0 204 125 602 ^S		
2.0 i.e.	04.93-05.94	83-85	Mot.-Nr. →7510272			GS,LLE	0 204 125 443 ^S		
2.0 i.e.	04.93-05.94	83-85	Ricam.Nr →7510272			LLE	0 204 125 444		0 204 120 517
2.0 i.e. 4x4	06.94-12.96	83-85	Ricam.Nr VETT.7510273→			LLE	0 204 125 436		
2.0 i.e. 4x4	04.93-05.94	83-85	Ricam.Nr →7510272			LLE	0 204 125 443 ^S		
	1.4, i.e.	04.93-12.96	51/56			RLE	F 026 005 092	19	
	1.6, i.e.	04.93-12.96	55/62/66			RLE	F 026 005 092	19	
	1.9D, TD	04.93-12.96	48/66			RLE	F 026 005 092	19	
	2.0 i.e.	04.93-12.96	83-85			RLE	F 026 005 092	19	
	2.0 i.e. 4x4	04.93-12.96	83-85			LLE	F 026 005 095	19	
	1.4	04.93-12.96	56				F 026 005 580	25,4	
	1.4 i.e.	04.94-12.96	51			RLE	F 026 005 580	25,4	
	1.6	04.93-12.96	62				F 026 005 580	25,4	
	1.6 i.e.	04.93-12.96	55			RLE	F 026 005 580	25,4	
		05.94-12.96	66			RLE	F 026 005 580	25,4	
	1.9D	04.93-04.95	48			RLE	0 204 163 080		
	1.9TD	04.93-12.96	66			RLE	F 026 005 581	25,4	
	2.0 i.e.	04.93-12.96	83-85			RLE	F 026 005 581	25,4	
	1.4, i.e.	04.93-12.96	51/56			LWR	0 204 131 221		
	1.6, i.e., i.e. Selecta	04.93-12.96	55/62/66			LWR	0 204 131 221		
	1.8 i.e.	04.93-12.96	66/71/77			LWR	0 204 131 221		
	1.9D, TD	04.93-12.96	48/66			NW	0 204 131 221		
	2.0 i.e.	04.93-12.96	83-85			LWR	0 204 131 221		
	1.4, i.e.	04.93-12.96	51/56				0 265 201 054 ^H		
	1.6, i.e., i.e. Selecta	04.93-12.96	55/62/66				0 265 201 054 ^H		
	1.8 i.e.	04.93-12.96	66/71/77				0 265 201 054 ^H		
	1.9D, TD	04.93-12.96	48/66				0 265 201 054 ^H		
	2.0 i.e.	04.93-12.96	83-85				0 265 201 054 ^H		
	2.0 i.e. 4x4	04.93-12.96	83-85				0 265 208 034 ^H		
	1.4, i.e.	04.93-12.96	51/56				0 265 100 042 ^H		
	1.6, i.e., i.e. Selecta	04.93-12.96	55/62/66				0 265 100 042 ^H		
	1.8 i.e.	04.93-12.96	66/71/77				0 265 100 042 ^H		
	1.9D, TD	04.93-12.96	48/66				0 265 100 042 ^H		
	2.0 i.e.	04.93-12.96	83-85				0 265 100 042 ^H		
	2.0 i.e. 4x4	04.93-12.96	83-85				0 265 105 035 ^H		
	2.0 i.e. 4x4	04.93-12.96	83-85			LAB	0 265 005 031 ^S		
						RAB	0 265 005 030 ^S		

◀ FIAT									
Tempra [159]									
	1.4	04.93-12.96	51/56		JBH,LLE	F 026 003 528	22,2		
	1.4 i.e.				RLE	0 204 122 268	22,22		
	1.6, i.e., i.e. Selecta	04.93-12.96	55/62/66		JBH,LLE	F 026 003 528	22,2		
					RLE	0 204 122 268	22,22		
	1.8 i.e.	04.93-12.96	66/71/77		JBH	F 026 003 528	22,2		
	1.9 D	04.93-12.96	48/66		JBH,LLE	F 026 003 528	22,2		
	1.9 TD				RLE	0 204 122 268	22,22		
	2.0 i.e.	04.93-12.96	83-85		JBH	F 026 003 528	22,2		
	1.4	04.93-05.94	51/56	Ricam.Nr →7510272	LLE	0 204 125 444		0 204 120 517	
	1.4 i.e.	04.93-12.96	51/56		RLE	0 204 125 602^S			
		06.94-12.96	51/56	Ricam.Nr 7510273→	LLE	0 204 125 436		0 204 120 995	
	1.6	04.93-05.94	62	Ricam.Nr →7510272	LLE	0 204 125 444		0 204 120 517	
		04.93-12.96	62		LLE	0 204 125 436		0 204 120 995	
					RLE	0 204 125 602^S			
	1.6 i.e.	04.93-05.94	55		LLE	0 204 125 443^S			
				Ricam.Nr →7510272	LLE	0 204 125 444		0 204 120 517	
		04.93-12.96	55		RLE	0 204 125 602^S			
		05.94-12.96	66		LLE	0 204 125 436		0 204 120 995	
					RLE	0 204 125 602^S			
		06.94-12.96	55	Ricam.Nr 7510273→	LLE	0 204 125 436		0 204 120 995	
	1.6 i.e. Selecta	04.93-12.96	55		LLE	0 204 125 436		0 204 120 995	
					RLE	0 204 125 602^S			
	1.8 i.e.	04.93-05.94	66	Mot.-Nr. →1509143	LLE	0 204 125 443^S			
			77	Mot.-Nr. →1509143	LLE	0 204 125 443^S			
		04.93-12.96	66		RLE	0 204 125 602^S			
				Mot.-Nr. →1509143	LLE	0 204 125 444		0 204 120 517	
				Mot.-Nr. 1509144→	LLE	0 204 125 436			
			77		RLE	0 204 125 602^S			
				Mot.-Nr. →1509143	LLE	0 204 125 444		0 204 120 517	
				Mot.-Nr. 1509144→	LLE	0 204 125 436			
		03.95-12.96	71	Mot.-Nr. →1509143	LLE	0 204 125 444		0 204 120 517	
				Mot.-Nr. 1509144→	LLE	0 204 125 436			
	1.9 D	04.93-05.94	48	Ricam.Nr →7510272	LLE	0 204 125 443^S		0 204 120 517	
						0 204 125 444		0 204 120 517	
		04.93-12.96	48		RLE	0 204 125 602^S			
		06.94-12.96	48	Ricam.Nr 7510273→	LLE	0 204 125 436		0 204 120 995	
	1.9 TD	04.93-05.94	66	Ricam.Nr →7510272	LLE	0 204 125 443^S			
						0 204 125 444		0 204 120 517	
		04.93-12.96	66		LLE	0 204 125 436		0 204 120 995	
					RLE	0 204 125 602^S			
	2.0 i.e.	04.93-05.94	83-85	Mot.-Nr. →7510272	GS,LLE	0 204 125 443^S			
				Ricam.Nr →7510272	LLE	0 204 125 444		0 204 120 517	
		06.94-12.96	83-85	Ricam.Nr VETT.7510273→	LLE	0 204 125 436			
	1.4, i.e.	04.93-12.96	51/56		RLE	F 026 005 092	19		
	1.6, i.e.	04.93-12.96	55/62/66		RLE	F 026 005 092	19		
	1.9 D, TD	04.93-12.96	48/66		RLE	F 026 005 092	19		
	2.0 i.e.	04.93-12.96	83-85		RLE	F 026 005 092	19		
	1.4	04.93-12.96	56			F 026 005 580	25,4		
	1.4 i.e.	04.93-12.96	51		RLE	F 026 005 580	25,4		
	1.6, i.e.	04.93-12.96	55/62/66		RLE	F 026 005 580	25,4		
	1.9 D	04.93-04.95	48		RLE	0 204 163 080			
	1.9 TD	04.93-12.96	66		RLE	F 026 005 581	25,4		
	2.0 i.e.	04.93-12.96	83-85		RLE	F 026 005 581	25,4		
	1.4, i.e.	04.93-12.96	51/56		LWR	0 204 131 221			
	1.6, i.e., i.e. Selecta	04.93-12.96	55/62/66		LWR	0 204 131 221			

		S							
	1.8 i.e.	04.93-12.96	66/71/77			LWR	0 204 131 221		
	1.9 D, TD	04.93-12.96	48/66			NIV	0 204 131 221		
	2.0 i.e.	04.93-12.96	83-85			LWR	0 204 131 221		
	1.4, i.e.	04.93-12.96	51/56				0 265 201 054 ^H		
	1.6, i.e., i.e. Selecta	04.93-12.96	55/62/66				0 265 201 054 ^H		
	1.8 i.e.	04.93-12.96	66/71/77				0 265 201 054 ^H		
	1.9 D, TD	04.93-12.96	48/66				0 265 201 054 ^H		
	2.0 i.e.	04.93-12.96	83-85				0 265 201 054 ^H		
	1.4, i.e.	04.93-12.96	51/56				0 265 100 042 ^H		
	1.6, i.e., i.e. Selecta	04.93-12.96	55/62/66				0 265 100 042 ^H		
	1.8 i.e.	04.93-12.96	66/71/77				0 265 100 042 ^H		
	1.9 D, TD	04.93-12.96	48/66				0 265 100 042 ^H		
	2.0 i.e.	04.93-12.96	83-85				0 265 100 042 ^H		
Tipo									
	1.6 MPI 8V	12.95-05.97	66				0 204 125 724		
Tipo [160..]									
	1.1 i.e.	10.94-10.95	37			JBH,LLE	F 026 003 528	22,2	
						RLE	0 204 122 268	22,22	
	1.4	03.93-10.95	51/52			JBH,LLE	F 026 003 528	22,2	
	1.4 i.e.					RLE	0 204 122 268	22,22	
	1.6, i.e., i.e. Selecta	03.93-10.95	56/58			JBH,LLE	F 026 003 528	22,2	
						RLE	0 204 122 268	22,22	
	1.7 D	03.93-10.95	42			JBH,LLE	F 026 003 528	22,2	
						RLE	0 204 122 268	22,22	
	1.8 i.e.	03.93-10.95	66			JBH,LLE	F 026 003 528	22,2	
			71/77			JBH,LLE	F 026 003 528	22,2	
		04.93-10.95	66			RLE	0 204 122 268	22,22	
	1.9 D Turbo	03.93-10.95	68			JBH,LLE	F 026 003 528	22,2	
						RLE	0 204 122 268	22,22	
	1.9 D, D Turbo	03.93-10.95	48/65			JBH,LLE	F 026 003 528	22,2	
	2.0 i.e.	03.93-10.95	85/104			JBH,LLE	F 026 003 528	22,2	
	2.0 i.e. 16V					RLE	0 204 122 268	22,22	
	1.1 i.e.	10.94-10.95	37			LLE	0 204 125 436		0 204 120 995
						RLE	0 204 125 602 ^S		0 204 120 517
	1.4, i.e.	03.93-05.94	51/52			LLE	0 204 125 443 ^S		0 204 120 517
		03.93-10.95	51/52			RLE	0 204 125 602 ^S		0 204 120 517
		06.94-10.95	51/52			LLE	0 204 125 436		0 204 120 995
	1.6	03.93-05.94	58			LLE	0 204 125 443 ^S		0 204 120 517
		03.93-10.95	58			RLE	0 204 125 602 ^S		0 204 120 517
		06.94-10.95	58			LLE	0 204 125 436		0 204 120 995
	1.6 i.e.	03.93-05.94	56			LLE	0 204 125 443 ^S		0 204 120 517
		06.94-10.95	56			LLE	0 204 125 436		0 204 120 995
	1.6 i.e. Selecta	03.93-09.94	56			LLE	0 204 125 443 ^S		0 204 120 517
		10.94-10.95	56			LLE	0 204 125 436		0 204 120 995
	1.6 i.e.	03.93-10.95	56			RLE	0 204 125 602 ^S		0 204 120 517
	1.6 i.e. Selecta								0 204 120 517



		S							
	◀ FIAT Tipo [160..]								
1.7 D		03.93-05.94	42		LLE		0 204 125 443 ^S		
							0 204 125 444		0 204 120 517
		03.93-10.95	42		RLE		0 204 125 602 ^S		
									0 204 120 517
		06.94-10.95	42		LLE		0 204 125 436		0 204 120 995
1.8 i.e.		03.93-10.95	66		LLE		0 204 125 436		0 204 120 995
							0 204 125 601 ^S		
			71/77		LLE		0 204 125 436		0 204 120 995
		04.93-10.95	66		RLE		0 204 125 602 ^S		
1.9 D Turbo		03.93-05.94	68		LLE		0 204 125 443 ^S		
							0 204 125 444		0 204 120 517
		03.93-10.95	68		RLE		0 204 125 602 ^S		
									0 204 120 517
		06.94-10.95	68		LLE		0 204 125 436		0 204 120 995
1.9 D		03.93-05.94	48/65		LLE		0 204 125 443 ^S		
1.9 D Turbo							0 204 125 444		0 204 120 517
		06.94-10.95	48/65		LLE		0 204 125 436		0 204 120 995
2.0 i.e.		03.93-05.94	85		LLE		0 204 125 443 ^S		
							0 204 125 444		0 204 120 517
		03.93-10.95	85		AG,LLE		0 204 125 436		0 204 120 995
					RLE		0 204 125 602 ^S		
									0 204 120 517
		06.94-10.95	85		LLE		0 204 125 436		0 204 120 995
2.0 i.e. 16V		03.93-10.95	104		LLE		0 204 125 436		0 204 120 995
							0 204 125 602 ^S		
									0 204 120 517
		1.1 i.e.	03.95-10.95	37		RLE	F 026 005 092	19	
		1.4, i.e.	03.95-10.95	51/52		RLE	F 026 005 092	19	
		1.6, i.e., i.e. Selecta	03.95-10.95	56/58		RLE	F 026 005 092	19	
		1.7 D	03.93-10.95	42		RLE	F 026 005 092	19	
		1.8 i.e.	03.93-10.95	66/71/77		RLE	F 026 005 092	19	
		1.9 D Turbo	03.93-10.95	65/68		RLE	F 026 005 092	19	
		2.0 i.e.	03.93-10.95	85		RLE	F 026 005 092	19	
		2.0 i.e. 16V	03.93-10.95	104		LLE	F 026 005 095	19	
		1.1 i.e.	10.94-10.95	37		RLE	F 026 005 580	25,4	
		1.4, i.e.	03.93-10.95	51/52		RLE	F 026 005 580	25,4	
		1.6, i.e., i.e. Selecta	03.93-10.95	56/58		RLE	F 026 005 580	25,4	
		1.7 D	03.93-07.95	42		RLE	0 204 163 080		
		1.8 i.e.	03.93-10.95	66/71/77		RLE	F 026 005 581	25,4	
		1.9 D Turbo	03.93-10.95	65/68		RLE	F 026 005 581	25,4	
		2.0 i.e.	03.93-10.95	85		RLE	F 026 005 581	25,4	
		2.0 i.e. 16V	03.93-10.95	104		LLE	F 026 005 581	25,4	
		1.1 i.e.	10.94-10.95	37			0 204 131 221		
		1.4, i.e.	03.93-10.95	51/52			0 204 131 221		
		1.6, i.e., i.e. Selecta	03.93-10.95	56/58			0 204 131 221		
		1.7 D	03.93-10.95	42			0 204 131 221		
		1.8 i.e.	03.93-10.95	66/71/77			0 204 131 221		
		1.9 D, D Turbo	03.93-10.95	48/65/68			0 204 131 221		
		2.0 i.e., i.e. 16V	03.93-10.95	85/104			0 204 131 221		
		1.1 i.e.	10.94-10.95	37			0 265 201 054 ^H		
		1.4, i.e.	03.93-10.95	51/52			0 265 201 054 ^H		
		1.6, i.e., i.e. Selecta	03.93-10.95	56/58			0 265 201 054 ^H		
		1.7 D	03.93-10.95	42			0 265 201 054 ^H		
		1.8 i.e.	03.93-10.95	66/71/77			0 265 201 054 ^H		
		1.9 D, D Turbo	03.93-10.95	48/65/68			0 265 201 054 ^H		
		2.0 i.e., i.e. 16V	03.93-10.95	85/104			0 265 201 054 ^H		

		S								
	1.1 i.e.	10.94-10.95	37				0 265 100 042 ^H			
	1.4, i.e.	03.93-10.95	51/52				0 265 100 042 ^H			
	1.6, i.e., i.e. Selecta	03.93-10.95	56/58				0 265 100 042 ^H			
	1.7 D	03.93-10.95	42				0 265 100 042 ^H			
	1.8 i.e.	03.93-10.95	66/71/77				0 265 100 042 ^H			
	1.9 D, D Turbo	03.93-10.95	48/65/68				0 265 100 042 ^H			
	2.0 i.e., i.e. 16V	03.93-10.95	85/104				0 265 100 042 ^H			
Ulysse [179..]										
	2.0 16V	10.02-10.05	100				0 204 123 592	22,2		
	2.0 16V JTD	10.02-10.05	79/80	Ricam.Nr →10570			0 204 123 592	22,2		
	2.2 16V JTD	10.02-10.05	94	Ricam.Nr →10570			0 204 123 592	22,2		
	3.0 V6 24V	01.03-10.05	150				0 204 123 592	22,2		
	2.0 16V	10.02-08.03	79/80/100	Ricam.Nr →9793			0 265 225 166 ^T			
2.0 16V JTD	10.02-01.06	79/80/100				0 265 222 010 ^B				
	10.02-08.03	94	Ricam.Nr →9793			0 265 225 166 ^T				
2.2 16V JTD	10.02-09.07	94				0 265 222 010 ^B				
	01.03-08.03	150	Ricam.Nr →9793			0 265 225 166 ^T				
3.0 V6 24V	01.03-10.05	150				0 265 222 010 ^B				
	2.0 16V, 16V JTD	10.02-10.05	79/80/100	Ricam.Nr →10570			0 265 005 290			
2.2 16V JTD	10.02-10.05	94	Ricam.Nr →10570			0 265 005 290				
	3.0 V6 24V	01.03-10.05	150	Ricam.Nr →10570			0 265 005 290			
Ulysse [220..]										
	1.8 i.e.	ABS 05.96-05.99	75	Ricam.Nr →8211	JBH,LLE		F 026 003 518	22,2		
	1.9 TD	ABO 01.95-05.99	66	Ricam.Nr →8211	JBH		F 026 003 166	23,8		
		06.99-12.99	66	Ricam.Nr 8212→	JBH		F 026 003 517	23,81		
		ABS 01.95-05.99	66	Ricam.Nr →8211			0 204 123 182	23,8		
	2.0 i.e. Turbo	06.99-12.99	66	Ricam.Nr 8212→	JBH		F 026 003 516	23,81		
		ABO 09.94-05.99	110	Ricam.Nr →8211	JBH		F 026 003 166	23,8		
		06.99-05.00	110	Ricam.Nr 8212→	JBH		F 026 003 517	23,81		
	2.0 i.e.	ABS 09.94-05.99	110	Ricam.Nr →8211			0 204 123 182	23,8		
		06.99-05.00	110	Ricam.Nr 8212→	JBH		F 026 003 516	23,81		
		ABO 09.94-05.99	90/97	Ricam.Nr →8211	JBH		F 026 003 166	23,8		
	2.0 i.e. 16V	06.99-05.00	90/97	Ricam.Nr 8212→	JBH		F 026 003 517	23,81		
		ABS 09.94-05.99	90/97	Ricam.Nr →8211			0 204 123 182	23,8		
		06.99-05.00	90/97	Ricam.Nr 8212→	JBH		F 026 003 516	23,81		
	2.0 i.e. 16V	ABO 03.00-09.02	100	Ricam.Nr 8212→	JBH		F 026 003 517	23,81		
		ABS 03.00-09.02	100	Ricam.Nr 8212→	JBH		F 026 003 516	23,81		
	2.0 JTD 8V	ABO 07.99-09.02	80	Ricam.Nr 8212→	JBH		F 026 003 517	23,81		
	2.0 JTD 8V, JTD 16V	ABS 07.99-09.02	80	Ricam.Nr 8212→	JBH		F 026 003 516	23,81		
	2.1 TD	ABO 05.96-05.99	80	Ricam.Nr →8211	JBH		F 026 003 166	23,8		
		06.99-10.99	80	Ricam.Nr 8212→	JBH		F 026 003 517	23,81		
		ABS 05.96-05.99	80	Ricam.Nr →8211			0 204 123 182	23,8		
		06.99-10.99	80	Ricam.Nr 8212→	JBH		F 026 003 516	23,81		
		1.9 TD	01.95-12.99	66		LLE		0 204 125 715		
		2.0 i.e.	09.94-05.00	90	Ricam.Nr →8574	LLE		0 204 125 715		
		2.0 i.e. 16V	03.00-09.02	100		LLE		0 204 125 715		
		2.0 JTD 8V, JTD 16V	07.99-09.02	80		LLE		0 204 125 715		
		2.1 TD	05.96-10.99	80		LLE		0 204 125 715		
		1.8 i.e.	05.96-05.00	75				0 204 131 085 ^A		
		1.9 TD	01.95-12.99	66				0 204 131 084 ^A		
2.0 i.e. Turbo, i.e. 16V		09.94-05.00	97/110				0 204 131 082 ^A			
2.0 i.e., JTD 8V		09.94-09.02	80/90				0 204 131 084 ^A			
2.1 TD		05.96-10.99	80				0 204 131 084 ^A			



		S							
◀ FIAT Ulysse [220..]									
	1.8 i.e.	06.97-12.99	75	Ricam.Nr 7480→8420	BO	0 265 216 496 ^B			
	1.9 TD	06.97-12.99	66	Ricam.Nr 7480→8420	BO	0 265 216 496 ^B			
	2.0 i.e., i.e. Turbo, i.e. 16V, JTD 8V	06.97-12.99	80/90/97/110	Ricam.Nr 7480→8420	BO	0 265 216 496 ^B			
	2.1 TD	06.97-10.99	80	Ricam.Nr 7480→8420	BO	0 265 216 496 ^B			
Uno Van [246..]									
	0.9	09.89-03.94	33		JBH,LLE	F 026 003 296	20,6		
	1.0 i.e.	09.89-03.94	33		JBH,LLE	F 026 003 296	20,6		
	1.7 D	01.91-03.94	42		JBH,LLE	F 026 003 296	20,6		
	1.0 i.e.	09.89-03.94	33		LLE	0 204 125 351			
	1.7 D	01.91-03.94	42		LLE	0 204 125 360			
	1.0 i.e.	09.89-03.94	33		RLE	0 204 162 081			
	1.0 i.e.	09.89-03.94	33	Fg.-Nr. →4730895, →6866583, →9021194	RLE	0 204 163 080			
				Fg.-Nr. 4730896→, 6866584→, 9021195→	RLE	F 026 005 587	25,4		
	0.9	09.89-03.94	33			0 204 131 223 ^A			
	1.0 i.e.	09.89-03.94	33			0 204 131 223 ^A			
	1.7 D	01.91-03.94	42			0 204 131 223 ^A			
Uno [146..]									
	1.0	01.98-04.99	33		BSY	0 204 122 185	20,64	0 204 124 101 ⁷	
	1.0 Base	09.89-03.94	33		JBH,LLE	F 026 003 296	20,6		
	1.0 DAV-15	09.89-03.94	32		JBH	F 026 003 296	20,6		
	1.0 i.e.	09.89-03.94	33		JBH,LLE	F 026 003 296	20,6		
		01.96-12.02	33		JBH,LLE	F 026 003 296	20,6		
	1.0 Trend	07.90-03.94	32		JBH,LLE	F 026 003 296	20,6		
	1.1	09.90-12.00	41		JBH,RLE	F 026 003 328	22,2		
	1.1 Espresso				RLE			0 204 124 102 ⁷	
	1.1 i.e.	09.89-03.94	36/37,5		JBH,LLE	F 026 003 296	20,6		
	1.4 DAV-15	09.89-03.94	52		JBH,LLE	F 026 003 296	20,6		
					JBH,RLE	F 026 003 328	22,2		
					RLE			0 204 124 102 ⁷	
	1.4 i	06.92-12.00	52			0 204 122 185	20,64	0 204 124 101 ⁷	
	1.4 i.e.	09.89-03.94	51		JBH,LLE	F 026 003 296	20,6		
					JBH,RLE	F 026 003 328	22,2		
					RLE			0 204 124 102 ⁷	
	1.4 Turbo i.e.	05.90-12.98	85		JBH,RLE	F 026 003 328	22,2		
					RLE			0 204 124 102 ⁷	
	1.5 i.e.	09.89-03.94	55		GS,JBH,RLE	F 026 003 328	22,2		
					GS,RLE			0 204 124 102 ⁷	
					JBH,LLE	F 026 003 296	20,6		
	1.5 i.e. Selecta	05.92-03.94	55		AG,RLE	0 204 122 185	20,64	0 204 124 101 ⁷	
					JBH,LLE	F 026 003 296	20,6		
	1.7 D	09.89-03.94	42		JBH,LLE	F 026 003 296	20,6		
		01.96-04.99	46		JBH	F 026 003 296	20,6		
	1.9 D	09.89-03.94	44		JBH,LLE	F 026 003 296	20,6		
	1.0	09.89-03.94	33		LLE	0 204 125 351			
		01.98-04.99	33		BSY			0 204 120 995	
	1.0 DAV-15, Trend	09.89-03.94	32		LLE	0 204 125 351			



		S							
	1.0 i.e.	09.89-03.94	33			LLE	0 204 125 351		
		01.96-12.02	33			LLE	0 204 125 351		
	1.1	01.98-12.03	40				0 204 125 351		
	1.1 i.e.	09.89-03.94	37,5			LLE	0 204 125 351		
	1.4 DAV-15, i.e.	09.89-03.94	51/52			LLE	0 204 125 351		
	1.5 i.e.	09.89-03.94	55			GS,LLE	0 204 125 351		
	1.5 i.e. Selecta	05.92-03.94	55			AG,LLE	0 204 125 360		
						AG,RLE	0 204 125 369		
	1.7 D	09.89-03.94	42			LLE	0 204 125 360		
		01.96-04.99	46				0 204 125 360		
	1.9 D	09.89-03.94	44			LLE	0 204 125 360		
	1.0	01.98-05.00	33				0 204 162 081		
	1.1 i.e.	09.89-03.94	36/37,5			RLE	0 204 162 081		
	1.2 i	04.00-03.04	44				0 204 162 081		
	1.4 DAV-15, i.e.	09.89-03.94	51/52			RLE	0 204 162 081		
	1.5 i.e., i.e. Selecta	09.89-03.94	55			RLE	0 204 162 081		
	1.7 D	01.98-03.04	42				0 204 162 081		
	1.0	01.98-05.00	33				F 026 005 581	25,4	
	1.1 i.e.	09.89-03.94	36				F 026 005 587	25,4	
			37,5	Ricam.Nr →0984009, →9307923		RLE	0 204 163 080		
	1.2 i	04.00-03.04	44				F 026 005 581	25,4	
	1.4 DAV-15, i.e.	09.89-03.94	51/52			RLE	0 204 163 080		
	1.5 i.e., i.e. Selecta	09.89-03.94	55			RLE	0 204 163 080		
	1.7 D	01.98-03.04	42				F 026 005 581	25,4	
	1.0	09.89-03.94	33				0 204 131 223^A		
		01.98-05.00	33				0 204 131 223^A		
	1.0 Base	09.89-03.94	33				0 204 131 223^A		
	1.0 DAV-15, Trend	09.89-03.94	32				0 204 131 223^A		
	1.0 i.e.	01.96-12.02	33				0 204 131 223^A		
	1.1	01.98-12.03	40				0 204 131 223^A		
	1.1 i.e.	09.89-03.94	36				0 204 131 223^A		
	1.4 DAV-15, i.e.	09.89-03.94	51/52				0 204 131 223^A		
	1.5 i.e., i.e. Selecta	09.89-03.94	55				0 204 131 223^A		
	1.7 D	09.89-03.94	42				0 204 131 223^A		
		01.96-04.99	46				0 204 131 223^A		
	1.9 D	09.89-03.94	44				0 204 131 223^A		
Uno [158..]									
	1.4	01.98-12.10	51			JBH	F 026 003 296	20,6	
	1.4	01.98-12.10	51				0 204 125 351		
	1.4	01.98-12.10	51				0 204 131 223^A		
500 [312]									
	0.9	09.10→	44/48/59/ 62,5			RLE	0 986 486 597	20,64	
	0.9	09.10→	48/62,5			TW	0 265 232 291^F 0 265 230 284^T		



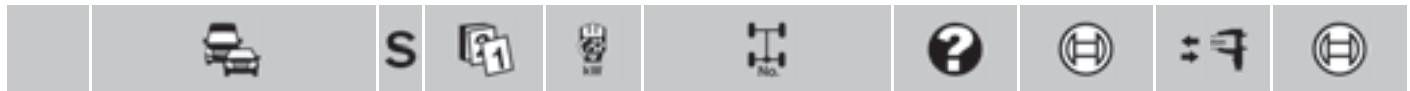

	◀ FIAT 500 [312]					
0.9	09.10→	48/62,5		TW	0 265 230 823 ^T	
					0 265 251 445 ^T	
1.2	07.07→	51			0 265 232 291 ^F	
1.2 LPG				TW	0 265 230 284 ^T	
					0 265 230 823 ^T	
					0 265 251 445 ^T	
1.3 MJTD	07.07-11.09	55	Fg.-Nr. →310995		0 265 230 284 ^T	
			Fg.-Nr. 310996→		0 265 230 823 ^T	
	07.07-12.12	55		TW	0 265 232 291 ^F	
	12.09-12.12	55			0 265 251 445 ^T	
1.3 Multijet	01.10→	70			0 265 251 445 ^T	
				TW	0 265 232 291 ^F	
1.4	07.07→	74			0 265 232 291 ^F	
				TW	0 265 230 284 ^T	
					0 265 230 823 ^T	
					0 265 251 445 ^T	
1.4 Abarth	05.08-11.09	99	Fg.-Nr. 310996→		0 265 230 823 ^T	
		132	Fg.-Nr. 310996→		0 265 230 823 ^T	
	05.08-12.12	132	Fg.-Nr. →310995		0 265 230 284 ^T	
	05.08→	99	Fg.-Nr. →310995		0 265 230 284 ^T	
	12.09-12.11	99			0 265 251 445 ^T	
		132			0 265 251 445 ^T	
	05.10-12.11	103			0 265 251 445 ^T	
	01.12-12.12	99		TW	0 265 251 445 ^T	
		103		TW	0 265 251 445 ^T	
		132		TW	0 265 251 445 ^T	
	01.13→	99			0 265 251 445 ^T	
		103			0 265 251 445 ^T	
	0.9	09.10→	44/48/59/62,5/77		0 265 005 823	
	1.2 , LPG	07.07→	51		0 265 005 607	
	1.3 MJTD, Multijet	07.07→	55/70		0 265 005 823	
	1.4	07.07→	74		0 265 005 607	
	1.4 Abarth	05.08→	99/103/132		0 265 005 823	

500C [312]

	0.9	09.10→	44/48/59/62,5	RLE	0 986 486 597	20,64
	Abarth 1.4	03.12-12.12	132	TW	0 265 251 445 ^T	
		01.13→	132		0 265 251 445 ^T	
	0.9	09.10→	48/62,5		0 265 232 291 ^F	
				TW	0 265 230 284 ^T	
					0 265 230 823 ^T	
					0 265 251 445 ^T	
	1.2	07.09→	51		0 265 232 291 ^F	
				TW	0 265 230 284 ^T	
					0 265 230 823 ^T	
					0 265 251 445 ^T	
	1.3 Multijet	07.09-11.09	55	Fg.-Nr. →310995	0 265 230 284 ^T	
				Fg.-Nr. 310996→	0 265 230 823 ^T	
		07.09-12.12	55	TW	0 265 232 291 ^F	
		12.09-12.12	55		0 265 251 445 ^T	
		01.10→	70		0 265 251 445 ^T	
				TW	0 265 232 291 ^F	
	1.4	07.09→	74		0 265 232 291 ^F	
				TW	0 265 230 284 ^T	
					0 265 230 823 ^T	
					0 265 251 445 ^T	

		S								
1.4 Abarth	09.09-11.09	103	Fg.-Nr. 310996→				0 265 230 823 ^T			
	09.09→	103	Fg.-Nr. →310995				0 265 230 284 ^T			
	12.09-12.11	103					0 265 251 445 ^T			
	07.10-12.11	99					0 265 251 445 ^T			
	01.12-12.12	99			TW		0 265 251 445 ^T			
		103			TW		0 265 251 445 ^T			
	01.13→	99					0 265 251 445 ^T			
		103					0 265 251 445 ^T			
	Abarth 1.4	03.12→	132					0 265 005 823		
	0.9	09.10→	44/48/59/62,5/77				0 265 005 823			
	1.2	07.09→	51					0 265 005 607		
	1.3 Multijet	07.09→	55/70				0 265 005 823			
	1.4	07.09→	74					0 265 005 607		
	1.4 Abarth	09.09→	99/103				0 265 005 823			
500L [199]										
	0.9	09.12→	59-62,5/		RLE			0 204 806 822		
	0.9 Natural Power		77	Ricam.Nr →5088552	LLE,SSG			0 204 781 367	22,2	
					LLE,SSG			0 204 781 368	22,2	
					LLE,SSG	Ricam.Nr 5088553→		0 204 805 850	22,2	
					LLE,SSG			0 204 805 851	22,2	
	1.3 Multijet	09.12→	62	Ricam.Nr →5088552	RLE			0 204 806 822		
					LLE,SSG			0 204 781 367	22,2	
					LLE,SSG	Ricam.Nr 5088553→		0 204 781 368	22,2	
					LLE,SSG			0 204 805 850	22,2	
	1.4	09.12→	70/88	Ricam.Nr →5088552	RLE			0 204 806 822		
					LLE,SSG			0 204 781 367	22,2	
					LLE,SSG	Ricam.Nr 5088553→		0 204 781 368	22,2	
LLE,SSG							0 204 805 850	22,2		
1.4 LPG			Ricam.Nr →5088552	LLE,SSG			0 204 781 367	22,2		
				LLE,SSG			0 204 781 368	22,2		
				LLE,SSG	Ricam.Nr 5088553→		0 204 805 850	22,2		
				LLE,SSG			0 204 805 851	22,2		
1.6 Multijet	03.13→	77/88	Ricam.Nr →5088552	RLE			0 204 806 822			
				LLE,SSG			0 204 781 367	22,2		
				LLE,SSG	Ricam.Nr 5088553→		0 204 781 368	22,2		
				LLE,SSG			0 204 805 850	22,2		
				LLE,SSG			0 204 805 851	22,2		
	0.9	09.12→	59-62,5/		LLE			0 204 781 366		
	0.9 Natural Power		77		RLE			0 204 806 823		
					LLE			0 204 781 366		
	1.3 Multijet	09.12→	62			LLE			0 204 781 366	
	1.4	09.12→	70/88		RLE			0 204 806 823		
					LLE			0 204 781 366		
1.4 LPG				RLE			0 204 806 823			
1.6 Multijet	03.13→	77/88		LLE			0 204 781 366			
				RLE			0 204 806 823			
500X [334]										
	1.4	11.14→	100-103/		LLE			0 204 824 666		
	1.4 4X4		120-125		RLE			0 204 123 824	23,81	
					LLE			0 204 824 666		
	1.6	11.14→	82/84-88			RLE			0 204 123 824	23,81
	1.6 Multijet				LLE			0 204 824 666		
2.0 Multijet	11.14→	100-103		RLE			0 204 123 824	23,81		
				LLE			0 204 824 666			
	1.4	11.14→	100-103/		LLE			0 204 824 665		
	1.4 4X4		120-125		RLE			0 204 125 950		
					LLE			0 204 824 665		
	1.6	11.14→	82/84-88			LLE			0 204 824 665	
1.6 Multijet				RLE			0 204 125 950			





	FIAT 500X [334]						
	2.0 Multijet	11.14→	100-103	LLE	0 204 824 665		
				RLE	0 204 125 950		

FORD

B-Max [12]

	1.0 EcoBoost	08.12→	74/88-92	LLE	0 204 123 789	20,64	
				RLE	0 204 123 807	20,64	
	1.4	08.12→	63/66	LLE	0 204 123 789	20,64	
				RLE	0 204 123 807	20,64	
	1.5 TDCi	08.12→	55	LLE	0 204 123 789	20,64	
				RLE	0 204 123 807	20,64	
	1.6 TDCi	08.12→	70/77	LLE	0 204 123 789	20,64	
	1.6 Ti-VCT			RLE	0 204 123 807	20,64	

	1.0 EcoBoost	08.12→	74/88-92	LLE	0 204 802 939		
				RLE	0 204 802 940		
	1.4	08.12→	63/66	LLE	0 204 802 939		
				RLE	0 204 802 940		
	1.5 TDCi	08.12→	55	LLE	0 204 802 939		
				RLE	0 204 802 940		
	1.6 TDCi	08.12→	70/77	LLE	0 204 802 939		
	1.6 Ti-VCT			RLE	0 204 802 940		

C-MAX [07]

	1.6, TDCi	03.07-07.10	66/74/80	LLE	0 986 486 150	19,05	
	1.8, FFV, TDCi	03.07-07.10	85/90-92	LLE	0 986 486 150	19,05	
	2.0, CNG, LPG, TDCi	03.07-07.10	81/93-107	LLE	0 986 486 150	19,05	
	1.6	03.07-07.10	74		0 986 486 611	28	
	1.8, FFV	03.07-07.10	90-92		0 986 486 611	28	

C-MAX [11]

	1.6 EcoBoost	08.10→	110/132-134	LLE,SSJ	0 986 486 150	19,05	
	1.6 TDCi	08.10→	70	LLE,SSJ	0 986 486 150	19,05	
			85	LLE,SSJ	0 986 486 150	19,05	
	1.6 Ti-VCT	08.10→	77	LLE	0 986 486 150	19,05	
		08.11→	63	LLE	0 986 486 150	19,05	
	1.6 Ti-VCT, Ti-VCT FlexiFuel	08.10→	86-88/92	LLE	0 986 486 150	19,05	
	2.0 TDCi	08.10→	100/103/120	LLE	0 986 486 150	19,05	

Cougar





















	2.0 i	08.98-12.00	96		0 204 123 548	25,4	
	2.5 i, i ST200	08.98-12.00	125/147-151		0 204 123 548	25,4	
	2.0 i	08.98-12.00	96	LLE	0 204 125 491		
				RLE	0 204 125 492		
	2.5 i	08.98-12.00	125/	LLE	0 204 125 491		
	2.5 i ST200		147-151	RLE	0 204 125 492		
	2.0 i	08.98-12.00	96		0 986 486 055	19,05	
	2.5 i, i ST200	08.98-12.00	125/147-151		0 986 486 055	19,05	

		S							
	2.0i	08.98-12.00	96				F 026	A06 033	
	2.0i	08.98-12.00	96				0 265	216 701^B 220 495^F	
	2.5i	08.98-12.00	125/				0 265	216 701^B	
	2.5i ST200		147-151				0 265	220 495^F	
Courier									
	1.3i	07.97-08.99	44			JBH	0 986	BB3 251	23,81
	1.4i 16V	07.97-08.99	66			JBH	0 986	BB3 251	23,81
	2.2D	01.90-04.95	44			STB	F 026	A01 558	
	2.5D, D Turbo 4WD, D Turbo 4x4	ABS 11.02-07.04	62/80				F 026	A06 504	
	1.3i	07.97-08.99	44				0 204	032 828	
	1.4i 16V	07.97-08.99	66				0 204	032 828	
Courier [PC]									
	2.6i	09.90-07.97	92				F 026	A02 533	
	2.6i 4x4								
Courier [PD]									
	2.6i	05.96-02.99	92				F 026	A01 713	
	2.6i 4x4	05.96-01.99	92				F 026	A01 712	
Courier [PE]									
	2.6i	02.99-10.02	92				F 026	A06 924	
	2.6i 4x4								
Econovan									
	2.2D	01.84-05.97	47			STB	F 026	A01 541	
	2.2D	04.84-10.96	47				F 026	A02 517	
Econovan [JG]									
	2.0	02.97-09.99	63			AG,VAN GS,V86,VAN	F 026	A01 676 A01 683	
	2.0	07.99-09.99	63				F 026	A01 925	
	2.0	02.97-09.99	63				F 026	A02 524	

























		S							
◀ FORD									
Escort									
	1.8 D	01.95-10.03	44/66			HYK,JBH	0 204 032 929		
	1.8 i 16V					HYK,WBH	0 204 032 602		
						HYK,JBH	0 204 032 823		
						HYK,WBH	0 204 032 615		
Escort [Fase I]									
	1.6 i	03.94-09.96	60			BRB, BSY	0 204 032 350		
	1.8 i	01.94-09.96	66			BRB, BSY	0 204 032 350		
	2.0 iXR3	01.92-09.96	85/88			BRB, BSY	0 204 032 350		
Escort [Fase II]									
	1.8 i 16V	09.96-10.02	85			HYK,JBH	0 204 032 929		
						HYK,WBH	0 204 032 602		
						HYK,JBH	0 204 032 823		
						HYK,WBH	0 204 032 615		
Escort Hobby									
	1.0	04.93-01.96	38				0 204 032 208		
	1.6	04.93-01.96	56				0 204 032 208		
Escort Sedan									
	1.6 i	01.01-08.02	70			HYK,JBH	0 204 032 929		
						HYK,WBH	0 204 032 602		
						HYK,JBH	0 204 032 823		
						HYK,WBH	0 204 032 615		
Escort Sedan [Fase II]									
	1.8 i 16V	09.96-02.00	85			HYK,JBH	0 204 032 929		
						HYK,WBH	0 204 032 602		
						HYK,JBH	0 204 032 823		
						HYK,WBH	0 204 032 615		
Escort SW									
	1.6 i	11.00-10.02	80			HYK,JBH	0 204 032 929		
						HYK,WBH	0 204 032 602		
						HYK,JBH	0 204 032 823		
	1.8 i 16V	09.96-10.02	85			HYK,JBH	0 204 032 929		
						HYK,WBH	0 204 032 615		
						WBH	0 204 032 602		



















































									
Escort VII Cabrio [95]									
									
	1.4 i	ABO 01.95-09.01	54			JBH	0 986 481 029	23,81	
		ABS, 08.95-09.01	54			JBH	0 986 480 986	23,8	
		OAS							
	1.8 TD	ABO 01.95-09.01	51/66			JBH	0 986 481 029	23,81	
		ABS, 08.95-09.01	51/66			JBH	0 986 480 986	23,8	
		OAS							
	1.4 i	ABO 01.95-09.01	54			RLE	0 204 125 071		
	1.8 TD	ABO 01.95-09.01	51/66			RLE	0 204 125 071		
Escort VII Express [95]									
									
	1.4 i 55	ABO 01.95-09.01	54			JBH	0 986 481 029	23,81	
	1.4 i 75	ABS, 08.95-09.01	54			JBH	0 986 480 986	23,8	
		OAS							
	1.8 D 55, D 75, TD	ABO 01.95-09.01	44/51			JBH	0 986 481 029	23,81	
		ABS, 08.95-09.01	44/51			JBH	0 986 480 986	23,8	
		OAS							
	1.4 i 55, i 75	ABO 01.95-09.01	54			RLE	0 204 125 071		
	1.8 D 55, D 75, TD	ABO 01.95-09.01	44/51			RLE	0 204 125 071		
	1.4 i 55, i 75	01.95-09.01	54				0 204 031 289^A		
	1.8 D 55, D 75, TD	01.95-09.01	44/51				0 204 031 289^A		
Escort VII RS [95]									
									
	2000	ABO 01.95-08.96	110			RLE	0 204 125 071		
	2000 4x4								
Escort VII Turnier [95]									
									
	1.3 i	ABO 01.95-09.01	44			JBH	0 986 481 029	23,81	
		ABS, 08.95-09.01	44			JBH	0 986 480 986	23,8	
		OAS							
	1.4 i	ABO 01.95-09.01	54			JBH	0 986 481 029	23,81	
		ABS, 08.95-09.01	54			JBH	0 986 480 986	23,8	
		OAS							
	1.6 i 16V	ABO 01.95-09.01	65/66			JBH	0 986 481 029	23,81	
		ABS, 08.95-09.01	65/66			JBH	0 986 480 986	23,8	
		OAS							
	1.8 D	ABO 01.95-09.01	44/51/66/			JBH	0 986 481 029	23,81	
	1.8 i 16V		77/85						
	1.8 TD	ABS, 08.95-09.01	44/51/66/			JBH	0 986 480 986	23,8	
		OAS	77/85						
	1.3 i	ABO 01.95-09.01	44			RLE	0 204 125 071		
	1.4 i	ABO 01.95-09.01	54			RLE	0 204 125 071		
	1.6 i 16V	ABO 01.95-09.01	65/66			RLE	0 204 125 071		
	1.8 D, i 16V, TD	ABO 01.95-09.01	44/51/66/77/85			RLE	0 204 125 071		





























										
◀ FORD										
Escort VII XR3i Cabrio [95]										
										
	1.6 i	ABO	01.95-09.01	65-66				JBH	0 986 481 029	23,81
		ABS,	08.95-09.01	65-66				JBH	0 986 480 986	23,8
		OAS								
	1.8 i	ABO	01.95-08.95	96					0 204 123 600	25,4
			01.95-09.01	77/85				JBH	0 986 481 029	23,81
		ABS,	08.95-09.01	77/85				JBH	0 986 480 986	23,8
		OAS								
	1.6 i	ABO	01.95-09.01	65-66				RLE	0 204 125 071	
	1.8 i	ABO	01.95-09.01	77/85/96				RLE	0 204 125 071	
Escort VII [95]										
										
	1.3 i	ABO	01.95-09.01	44				JBH	0 986 481 029	23,81
		ABS,	08.95-09.01	44				JBH	0 986 480 986	23,8
		OAS								
	1.4 i	ABO	01.95-09.01	54				JBH	0 986 481 029	23,81
		ABS,	08.95-09.01	54				JBH	0 986 480 986	23,8
		OAS								
	1.6 i 16V	ABS,	08.95-09.01	65/66				JBH	0 986 480 986	23,8
		OAS								
	1.6 i 16V, i 16V 4x4	ABO	01.95-09.01	65/66				JBH	0 986 481 029	23,81
	1.8 D	ABO	01.95-09.01	44/51/66/77/85				JBH	0 986 481 029	23,81
	1.8 i 16V	ABS,	08.95-09.01	44/51/66/				JBH	0 986 480 986	23,8
	1.8 TD	OAS		77/85						
	1.3 i	ABO	01.95-09.01	44				RLE	0 204 125 071	
	1.4 i	ABO	01.95-09.01	54				RLE	0 204 125 071	
	1.6 i 16V, i 16V 4x4	ABO	01.95-09.01	65/66				RLE	0 204 125 071	
	1.8 D, i 16V, TD	ABO	01.95-09.01	44/51/66/77/85				RLE	0 204 125 071	
Escort V/VI Cabrio [91]										
										
	1.4 i	ABO	08.90-12.94	52/54-55				JBH	F 026 003 594	23,8
	1.6 i 16V	ABO	02.93-12.94	65/66				JBH	F 026 003 594	23,8
	1.4 i	ABO	08.90-12.94	52				RLE	0 204 125 071	
	1.6 i 16V	ABO	02.93-12.94	65/66				RLE	0 204 125 071	
Escort V/VI Express [91]										
										
	1.3	ABO	08.90-12.94	46				JBH	F 026 003 594	23,8
	1.4 i	ABO	08.90-12.94	52				JBH	F 026 003 594	23,8
	1.8 D	ABO	08.90-12.94	44				JBH	F 026 003 594	23,8
	1.3	ABO	08.90-12.94	46				RLE	0 204 125 071	
	1.4 i	ABO	08.90-12.94	52				RLE	0 204 125 071	
	1.8 D	ABO	08.90-12.94	44				RLE	0 204 125 071	
	1.3		08.90-12.94	46					0 204 031 289^A	
	1.4 i		08.90-12.94	52					0 204 031 289^A	
	1.8 D		08.90-12.94	44					0 204 031 289^A	



									
Escort V/VI RS [91]									
									
	2000	ABO	05.91-12.94	110		JBH	F 026 003 594	23,8	
	2.0i Cosworth	ABO	04.92-12.94	162		RLE	0 204 125 071		
	2000	ABO	05.91-12.94	110		RLE	0 204 125 071		
Escort V/VI Turnier [91]									
									
	1.3, i	ABO	08.90-12.94	44		JBH	F 026 003 594	23,8	
	1.4 i	ABO	08.90-12.94	52/54-55		JBH	F 026 003 594	23,8	
	1.6, i 16V	ABO	08.90-12.94	65/66		JBH	F 026 003 594	23,8	
	1.8 D, i 16V, TD	ABO	08.90-12.94	44/66/77		JBH	F 026 003 594	23,8	
	1.8 i 16V	ABO	02.92-11.94	96		254	0 204 123 402	25,4	
			02.92-12.94	96		JBH	F 026 003 594	23,8	
			12.94-12.94	96		254	0 204 123 600	25,4	
	1.3, i	ABO	08.90-12.94	44		RLE	0 204 125 071		
	1.4 i	ABO	08.90-12.94	52/54-55		RLE	0 204 125 071		
	1.6, i 16V	ABO	08.90-12.94	65/66		RLE	0 204 125 071		
	1.8 D, i 16V, TD	ABO	08.90-12.94	44/66/77/96		RLE	0 204 125 071		
Escort V/VI XR3i Cabrio [91]									
									
	1.8 i	ABO	02.92-11.94	96		254	0 204 123 402	25,4	
			02.92-12.94	77		JBH	F 026 003 594	23,8	
				96		JBH	F 026 003 594	23,8	
			12.94-12.94	96		254	0 204 123 600	25,4	
	1.8 i	ABO	02.92-12.94	77/96		RLE	0 204 125 071		
Escort V/VI XR3i [91]									
									
	1.8 i	ABO	02.92-11.94	96		254	0 204 123 402	25,4	
			02.92-12.94	77		JBH	F 026 003 594	23,8	
				96		JBH	F 026 003 594	23,8	
			12.94-12.94	96		254	0 204 123 600	25,4	
	1.8 i	ABO	02.92-12.94	77/96		RLE	0 204 125 071		
Escort V/VI [91]									
									
	1.1	ABO	08.90-12.94	40		JBH	F 026 003 594	23,8	
	1.3, i	ABO	08.90-12.94	44/46		JBH	F 026 003 594	23,8	
	1.4, i	ABO	08.90-12.94	52/54-55		JBH	F 026 003 594	23,8	
	1.6, i 16V	ABO	08.90-12.94	65/66		JBH	F 026 003 594	23,8	
	1.8 D, i 16V, TD	ABO	08.90-12.94	44/66/77		JBH	F 026 003 594	23,8	
	1.1	ABO	08.90-12.94	40		RLE	0 204 125 071		
	1.3, i	ABO	08.90-12.94	44/46		RLE	0 204 125 071		
	1.4, i	ABO	08.90-12.94	52/54		RLE	0 204 125 071		
	1.6, i 16V	ABO	08.90-12.94	65/66		RLE	0 204 125 071		
	1.8 D, i 16V, TD	ABO	08.90-12.94	44/66/77		RLE	0 204 125 071		



		S							
◀ FORD									
Explorer [EX]									
									
	4.0 i		10.96-08.97	152			F 026 A01 754		
Fairlane [NC II]									
									
	4.0 i		03.92-02.95	148			F 026 A07 195		F 026 A08 384
Fairlane [NL]									
									
	4.0 i		09.96-02.99	162	4SB		F 026 A07 167		
Falcon									
									
	4.0 i		04.96→	157	TW		F 026 A07 152		
							F 026 A07 167		
							F 026 A07 173		
							F 026 A07 175		
Falcon [AU III]									
									
	4.0 LPG		04.01-09.02	143	KOB		F 026 A07 173		
					SED,TKO		F 026 A07 175		
					SED,TKO		F 026 A07 171		
Falcon [EF]									
									
	4.0 i		09.94-09.95	157	KOB		F 026 A07 168		
					SED		F 026 A07 167		
Falcon Utility [XG]									
									
	4.0		03.97→	148/157			F 026 A07 169		
Festiva Hatchback [WA]									
									
	1.3		10.91-03.94	46	STB		F 026 A06 718		
Fiesta									
									
	1.4 i	ABO	10.98-02.00	55	JBH,RLE		0986 480 679	22,2	





Fiesta [Fase II]

	1.0i		04.96-06.06	39/48		JBH	0 986 BB3 250	22,22
	1.3i		04.96-08.99	44		JBH	0 986 BB3 250	22,22
	1.4i 16V		04.96-08.99	66		JBH	0 986 BB3 251	23,81
	1.6i		09.99-04.05	70		JBH	0 986 BB3 251	23,81

Fiesta III Courier [89]

	1.3, i	ABO	09.91-01.94	44		JBH	0 986 480 677	22,2
	1.8D	ABO	09.91-01.94	44		JBH	0 986 480 677	22,2
	1.3		09.91-01.94	44		LLE	0 986 485 119	
	1.3i		09.91-08.96	44		RLE	0 986 485 090	
			02.94-08.96	44		LLE	0 986 485 120	
	1.8D		09.91-01.94	44		LLE	0 986 485 119	
			09.91-08.96	44		RLE	0 986 485 090	
			02.94-08.96	44		LLE	0 986 485 120	
	1.3, i		09.91-08.96	44			0 204 031 294^A	
	1.8D		09.91-08.96	44			0 204 031 294^A	

Fiesta III [89]

	1.0	ABO	03.89-02.94	33		JBH, KHD	0 986 480 677	22,2
			09.91-02.94	33		JBH, KHD	0 986 480 661	20,6
			03.94-12.96	33		JBH, KHD	0 986 480 973	20,6
		ABS	03.89-01.94	33		JBH	0 986 480 126	22,2
			03.94-12.96	33		JBH	0 986 480 972	23,8
	1.1	ABO	03.89-02.94	36-37/40		JBH, KHD	0 986 480 677	22,2
	1.1i		09.91-02.94	36-37/40		JBH, KHD	0 986 480 661	20,6
			03.94-12.96	36-37/40		JBH, KHD	0 986 480 973	20,6
		ABS	03.89-01.94	36-37/40		JBH	0 986 480 126	22,2
			03.94-12.96	36-37/40		JBH	0 986 480 972	23,8
	1.3	ABO	06.91-02.94	43-44		JBH, KHD	0 986 480 677	22,2
	1.3i		09.91-02.94	43-44		JBH, KHD	0 986 480 661	20,6
			03.94-12.96	43-44		JBH, KHD	0 986 480 973	20,6
		ABS	06.91-01.94	43-44		JBH	0 986 480 126	22,2
			03.94-12.96	43-44		JBH	0 986 480 972	23,8
	1.4	ABO	03.89-02.94	55		JBH, KHD	0 986 480 677	22,2
			09.91-02.94	55		JBH, KHD	0 986 480 661	20,6
			03.94-12.96	55		JBH, KHD	0 986 480 973	20,6
	1.4	ABO	03.89-02.94	52/54		JBH, KHD	0 986 480 677	22,2
	1.4i		09.91-02.94	52/54		JBH, KHD	0 986 480 661	20,6
			03.94-12.96	52/54		JBH, KHD	0 986 480 973	20,6
		ABS	03.89-01.94	52/54-55		JBH	0 986 480 126	22,2
			03.94-12.96	52/54-55		JBH	0 986 480 972	23,8
	1.4i	ABO	01.94-02.94	54-55		JBH, KHD	0 986 480 677	22,2
						JBH, KHD	0 986 480 661	20,6
	1.6	ABO	03.89-01.94	66		JBH	0 986 480 677	22,2
	1.6, Turbo, XR2i	ABS	03.89-01.94	66/76/81/96-98		JBH	0 986 480 126	22,2
			03.94-12.96	66/76/81/96-98		JBH	0 986 480 972	23,8
	1.6i 16V	ABS	03.94-12.96	65-66		JBH	0 986 480 972	23,8
	1.6 Turbo, XR2i		03.89-02.94	76/81/96-98		JBH	0 986 480 677	22,2
	1.8D	ABO	03.89-02.94	44		JBH, KHD	0 986 480 677	22,2
			09.91-02.94	44		JBH, KHD	0 986 480 661	20,6
			03.94-12.96	44		JBH, KHD	0 986 480 973	20,6
		ABS	03.89-01.94	44		JBH	0 986 480 126	22,2
			03.94-12.96	44		JBH	0 986 480 972	23,8



		S							
◀ FORD Fiesta III [89]									
	1.8 i 16V	ABO	02.92-01.94	77/93-96		JBH	0 986 480 677	22,2	
	1.8 XR2i 16V	ABS	02.92-01.94	77/93-96		JBH	0 986 480 126	22,2	
			02.94-12.96	77/93-96		JBH	0 986 480 972	23,8	
	1.0		03.89-01.94	33		LLE	0 986 485 119		
			03.89-12.96	33		RLE	0 986 485 090		
		02.94-12.96	33		LLE	0 986 485 120			
	1.1		03.89-01.94	36-37/40		LLE	0 986 485 119		
	1.1 i		03.89-12.96	36-37/40		RLE	0 986 485 090		
			02.94-12.96	36-37/40		LLE	0 986 485 120		
	1.3		06.91-01.94	43-44		LLE	0 986 485 119		
	1.3 i		06.91-12.96	43-44		RLE	0 986 485 090		
			02.94-12.96	43-44		LLE	0 986 485 120		
	1.4		03.89-01.94	55		LLE	0 986 485 119		
			03.89-12.96	55		RLE	0 986 485 090		
			02.94-12.96	55		LLE	0 986 485 120		
	1.4 i		03.89-01.94	52/54		LLE	0 986 485 119		
			03.89-12.96	52/54		RLE	0 986 485 090		
			02.94-12.96	52/54		LLE	0 986 485 120		
	1.4 i		01.94-12.96	54-55		RLE	0 986 485 090		
			02.94-12.96	54-55		LLE	0 986 485 120		
	1.6, Turbo, XR2i		03.89-01.94	66/76/81/96-98		LLE	0 986 485 119		
			03.89-12.96	66/76/81/96-98		RLE	0 986 485 090		
			02.94-12.96	66/76/81/96-98		LLE	0 986 485 120		
	1.6 i 16V		02.94-12.96	65-66		LLE	0 986 485 120		
						RLE	0 986 485 090		
	1.8 D		03.89-01.94	44/77/93-96		LLE	0 986 485 119		
	1.8 i 16V		03.89-12.96	44/77/93-96		RLE	0 986 485 090		
	1.8 XR2i 16V		02.94-12.96	44/77/93-96		LLE	0 986 485 120		
	1.0		03.89-08.96	33		TW	0 204 031 294 ^A		
	1.1, i		03.89-08.96	36-37/40		TW	0 204 031 294 ^A		
	1.3, i		06.91-08.96	43-44		TW	0 204 031 294 ^A		
	1.4, i		03.89-08.96	52/54-55		TW	0 204 031 294 ^A		
	1.6, i 16V, Turbo, XR2i		03.89-08.96	65-66/76/81/96-98		TW	0 204 031 294 ^A		
	1.8 D, i 16V, XR2i 16V		03.89-08.96	44/77/93-96		TW	0 204 031 294 ^A		
	Fiesta IV Courier [96]								
	1.3 i	ABO	11.95-02.00	44		JBH	0 986 480 995	23,81	
		ABS	11.95-02.00	44		JBH	0 986 480 698	23,8	
	1.4 i	ABO	01.96-02.00	66		JBH	0 986 480 995	23,81	
		ABS	01.96-02.00	66		JBH	0 986 480 698	23,8	
	1.8 D	ABO	10.95-02.00	44		JBH	0 986 480 995	23,81	
	1.8 D, TD	ABS	10.95-02.00	44/55		JBH	0 986 480 698	23,8	
	1.3 i	ABO	11.95-02.00	44		LLE	0 986 485 129		
		ABS	11.95-02.00	44		LLE	0 986 485 130		
	1.4 i	ABO	01.96-02.00	66		LLE	0 986 485 129		
		ABS	01.96-02.00	66		LLE	0 986 485 130		
	1.8 D	ABS	10.95-02.00	44		LLE	0 986 485 130		
	1.8 D, TD	ABO	10.95-02.00	44/55		LLE	0 986 485 129		
	1.3 i		09.98-12.02	44			0 986 486 067	19,05	
	1.4 i		09.98-12.00	66			0 986 486 067	19,05	
	1.8 D, TD		09.98-12.02	44/55			0 986 486 067	19,05	
	1.3 i		12.95-12.02	44			0 204 131 362 ^A		
	1.4 i		01.96-12.00	66			0 204 131 362 ^A		
	1.8 D, TD		12.95-12.02	44/55			0 204 131 362 ^A		



Fiesta IV [96]



	1.3 i	ABO 11.95-02.00 37/44		JBH	0 986 480 679	22,2
		ABS 11.95-02.00 37/44		JBH	0 986 480 678	22,2
	1.4 i 16V	ABO 01.96-02.00 66		JBH	0 986 480 697	23,8
		ABS 01.96-02.00 66		JBH	0 986 480 698	23,8
	1.8 D	ABO 10.95-02.00 44/55		JBH	0 986 480 679	22,2
	1.8 TD	ABS 10.95-02.00 44/55		JBH	0 986 480 698	23,8
	1.25 i 16V	ABO 11.95-02.00 55		AG,JBH	0 986 480 697	23,8
				GS,JBH	0 986 480 679	22,2
		ABS 11.95-02.00 55		AG,JBH	0 986 480 698	23,8
				GS,JBH	0 986 480 678	22,2

	1.3 i	ABO 11.95-02.00 37/44		LLE	0 986 485 129	
		ABS 11.95-02.00 37/44		LLE	0 986 485 130	
	1.4 i 16V	ABO 01.96-02.00 66		LLE	0 986 485 129	
		ABS 01.96-02.00 66		LLE	0 986 485 130	
	1.6 i 16V	ABO 02.00-02.00 76		LLE	0 986 485 129	
		ABS 02.00-02.00 76		LLE	0 986 485 130	
	1.8 D	ABS 10.95-02.00 44		LLE	0 986 485 130	
	1.8 D, TD	ABO 10.95-02.00 44/55		LLE	0 986 485 129	
	1.25 i 16V	ABO 11.95-02.00 55		LLE	0 986 485 129	
		ABS 11.95-02.00 55		LLE	0 986 485 130	

	1.3 i	09.98-12.02 37/44			0 986 486 067	19,05	
		1.4 i 16V	09.98-12.00 66			0 986 486 067	19,05
		1.6 i 16V	02.00-12.02 76			0 986 486 067	19,05
		1.8 D, TD	09.98-12.02 44/55			0 986 486 067	19,05
		1.25 i 16V	09.98-12.02 55			0 986 486 067	19,05

	1.3 i	12.95-12.02 37/44			0 204 131 362 ^A		
		1.4 i 16V	01.96-12.00 66			0 204 131 362 ^A	
		1.6 i 16V	02.00-12.02 76			0 204 131 362 ^A	
		1.8 D, TD	12.95-12.02 44/55			0 204 131 362 ^A	
		1.25 i 16V	12.95-12.02 55			0 204 131 362 ^A	

Fiesta V [02]



	1.3 i	ABO 11.01-09.08 44/51		LLE	0 986 481 063	23,81	
		ABS, 11.01-09.08 44/51		LLE	0 986 481 061	23,81	
		MFD					
		ABS, 11.01-09.08 44/51		LLE	0 986 481 062	23,81	
	1.4 i	ABO 11.01-09.08 50/56-59		LLE	0 986 481 063	23,81	
		1.4 TDCi	ABS, 11.01-09.08 50/56-59		LLE	0 986 481 061	23,81
	1.6 i	MFD					
		ABS, 11.01-09.08 50/56-59		LLE	0 986 481 062	23,81	
		OFD					
		ABS, 11.01-09.08 66/74		LLE	0 986 481 063	23,81	
	1.6 TDCi	ABS, 11.01-09.08 66/74		LLE	0 986 481 061	23,81	
		MFD					
		ABS, 11.01-09.08 66/74		LLE	0 986 481 062	23,81	
		OFD					
	1.25 i	ABO 12.02-09.08 51/55		LLE	0 986 481 063	23,81	
		ABS, 12.02-09.08 51/55		LLE	0 986 481 061	23,81	
		MFD					
		ABS, 12.02-09.08 51/55		LLE	0 986 481 062	23,81	
		OFD					
	2.0 i ST150	ABO 11.04-09.08 110		LLE	0 986 481 063	23,81	



		S							
	◀ FORD Fiesta V [02]								
2.0 iST150		ABS, 11.04-09.08	110			LLE	0986 481 061	23,81	
		MFD							
		ABS, 11.04-09.08	110			LLE	0986 481 062	23,81	
		OFD							
Fiesta VI [08]									
	1.4 i	MFD 07.08-11.12	68-71			LLE	0 204 123 789	20,64	
	1.4 LPG					RLE	0 204 123 807	20,64	
	1.4 i, LPG, TDCi	OFD 07.08-11.12	50/51/ 68-71			LLE	0 204 788 353	20,64	
						RLE	0 204 123 806	20,64	
	1.4 TDCi	09.10-11.12	51			LLE	0 204 123 789	20,64	
		MFD 07.08-11.12	50			LLE	0 204 123 789	20,64	
						RLE	0 204 123 807	20,64	
		09.10-11.12	51			LLE	0 204 123 789	20,64	
						RLE	0 204 123 807	20,64	
	1.6 TDCi	MFD 07.08-11.12	55/66/70/ 88			LLE	0 204 123 789	20,64	
	1.6 TDCi ECOnetic					RLE	0 204 123 807	20,64	
	1.6 Ti-VCT	OFD 07.08-11.12	55/66/70/ 88			LLE	0 204 788 353	20,64	
						RLE	0 204 123 806	20,64	
	1.6 Ti-VCT Sport S	01.11-11.12	99			LLE	0 204 123 789	20,64	
						RLE	0 204 123 807	20,64	
	1.25 i	MFD 07.08-11.12	44/60			LLE	0 204 123 789	20,64	
						RLE	0 204 123 807	20,64	
		OFD 07.08-11.12	44/60			LLE	0 204 788 353	20,64	
						RLE	0 204 123 806	20,64	
	1.4 i	07.08-06.11	71			LLE	0 204 125 935		
						RLE	0 204 125 937		
		MFD 07.11-11.12	71			LLE	0 204 125 935		
						RLE	0 204 125 937		
	1.4 LPG	05.09-06.11	68-71			LLE	0 204 125 935		
						RLE	0 204 125 937		
		MFD 07.11-11.12	68-71			LLE	0 204 125 935		
						RLE	0 204 125 937		
	1.4 TDCi	07.08-06.11	50			LLE	0 204 125 935		
						RLE	0 204 125 937		
		09.10-06.11	51			LLE	0 204 125 935		
						RLE	0 204 125 937		
		MFD 07.11-11.12	50			LLE	0 204 125 935		
						RLE	0 204 125 937		
			51			LLE	0 204 125 935		
						RLE	0 204 125 937		
	1.6 TDCi	07.08-06.11	66			LLE	0 204 125 935		
						RLE	0 204 125 937		
		01.09-06.11	55			LLE	0 204 125 935		
						RLE	0 204 125 937		
		03.10-06.11	70			LLE	0 204 125 935		
						RLE	0 204 125 937		
		MFD 07.11-11.12	55			LLE	0 204 125 935		
						RLE	0 204 125 937		
			66			LLE	0 204 125 935		
						RLE	0 204 125 937		
			70			LLE	0 204 125 935		
						RLE	0 204 125 937		
	1.6 TDCi ECOnetic	MFD 02.12-11.12	70			LLE	0 204 125 935		
						RLE	0 204 125 937		
	1.6 Ti-VCT	07.08-06.11	88			LLE	0 204 125 935		
						RLE	0 204 125 937		
		MFD 07.11-11.12	88			LLE	0 204 125 935		
						RLE	0 204 125 937		



1.6 Ti-VCT Sport S	01.11-11.12	99			LLE	0 204 125 935		
					RLE	0 204 125 937		
1.25 i	07.08-06.11	44			LLE	0 204 125 935		
		60			RLE	0 204 125 937		
	MFD 07.11-11.12	44			LLE	0 204 125 935		
		60			RLE	0 204 125 937		

Fiesta VII [13]

	1.0 EcoBoost	08.14→	103		LLE	0 204 123 789	20,64
					RLE	0 204 123 807	20,64
	1.0 EcoBoost	MFD 11.12→	48/59/74/		LLE	0 204 123 789	20,64
	1.0 GDI		92		RLE	0 204 123 807	20,64
		OFD 11.12→	48/59/74/		LLE	0 204 788 353	20,64
			92		RLE	0 204 123 806	20,64
	1.4	MFD 11.12→	68-71		LLE	0 204 123 789	20,64
					RLE	0 204 123 807	20,64
		OFD 11.12→	68-71		LLE	0 204 788 353	20,64
					RLE	0 204 123 806	20,64
	1.5 TDCi	MFD 11.12→	55		LLE	0 204 123 789	20,64
					RLE	0 204 123 807	20,64
		OFD 11.12→	55		LLE	0 204 788 353	20,64
					RLE	0 204 123 806	20,64
	1.6 TDCi	MFD 11.12→	70/77		LLE	0 204 123 789	20,64
	1.6 TDCi ECONetic				RLE	0 204 123 807	20,64
	1.6 Ti-VCT	OFD 11.12→	70/77		LLE	0 204 788 353	20,64
					RLE	0 204 123 806	20,64
	1.25	MFD 11.12→	44/60		LLE	0 204 123 789	20,64
					RLE	0 204 123 807	20,64
		OFD 11.12→	44/60		LLE	0 204 788 353	20,64
					RLE	0 204 123 806	20,64

	1.0 EcoBoost	MFD 11.12→	48/59/74/		LLE	0 204 125 935	
	1.0 GDI		92/103		RLE	0 204 125 937	
	1.4	MFD 11.12→	68-71		LLE	0 204 125 935	
					RLE	0 204 125 937	
	1.5 TDCi	MFD 11.12→	55		LLE	0 204 125 935	
					RLE	0 204 125 937	
	1.6 TDCi, TDCi ECONetic, Ti-VCT	MFD 11.12→	70/77		LLE	0 204 125 935	
					RLE	0 204 125 937	
	1.25	MFD 11.12→	44/60		LLE	0 204 125 935	
					RLE	0 204 125 937	

Focus C-MAX [04]

	1.6, TDCi, Ti-VCT	ABS 06.03-03.07	66/74/80/85		JBH	0 986 480 994	23,81
	1.8, FFV, TDCi	ABS 06.03-03.07	85/88/90-92		JBH	0 986 480 994	23,81
	2.0, CNG, TDCi	ABS 06.03-03.07	93-107		JBH	0 986 480 994	23,81
	1.6, TDCi, Ti-VCT	06.03-03.07	66/74/80/85		LLE	0 986 486 150	19,05
	1.8, FFV, TDCi	06.03-03.07	85/88/90-92		LLE	0 986 486 150	19,05
	2.0, CNG, TDCi	06.03-03.07	93-107		LLE	0 986 486 150	19,05
	1.6, Ti-VCT	02.06-03.07	74/85			0 986 486 611	28
	1.8, FFV	02.06-03.07	90-92	Get.-Nr. B5/IB5		0 986 486 611	28



			S							
◀ FORD										
Focus [Fase I]										
	1.6 i8V		09.03→	75			JBH	F 026 003 608	23,81	
	1.8 i16V	ABO	09.00-07.04	85			JBH	F 026 003 608	23,81	
		ABS	09.00-07.04	85				0 204 123 701	23,81	
	2.0 i16V	ABO	07.00-05.05	96-97			JBH	F 026 003 608	23,81	
		ABS	07.00-05.05	96-97				0 204 123 701	23,81	
Focus [GA]										
	2.0 i		10.98-01.02	96				0 204 123 547		
Focus I Turnier [99]										
	1.4 i	ABO	11.98-05.05	55			JBH,LLE	F 026 003 608	23,81	
							RLE	F 026 003 701	23,81	
		ABS,	11.98-10.01	55			JBH	0 986 481 000	23,81	
		MFD								
		ABS,	11.98-10.00	55				F 026 003 701	23,81	
		OFD	11.00-05.05	55				0 204 123 701	23,81	
	1.6 i	ABO	11.98-05.05	74			JBH,LLE	F 026 003 608	23,81	
							RLE	F 026 003 701	23,81	
			09.02-05.05	72			JBH,LLE	F 026 003 608	23,81	
							RLE	F 026 003 701	23,81	
		ABS,	11.98-10.00	74				F 026 003 701	23,81	
		OFD	11.00-05.05	74				0 204 123 701	23,81	
			09.02-05.05	72				0 204 123 701	23,81	
	1.6 iFFV	ABO	10.01-05.05	74-77			JBH,LLE	F 026 003 608	23,81	
							RLE	F 026 003 701	23,81	
		ABS,	10.01-05.05	74-77				0 204 123 701	23,81	
		OFD								
	1.6 i	ABS,	11.98-10.01	74-77			JBH	0 986 481 000	23,81	
	1.6 iFFV	MFD								
	1.8 i	ABO	11.98-05.05	85			RLE	F 026 003 701	23,81	
		ABS,	11.98-10.00	85				F 026 003 701	23,81	
		OFD								
	1.8 i	ABO	11.98-05.05	85			JBH,LLE	F 026 003 608	23,81	
	1.8 TDCi	ABS,	11.00-05.05	85				0 204 123 701	23,81	
		OFD								
	1.8 i, TDCi, TDDi	ABS,	11.98-10.01	55/66/85			JBH	0 986 481 000	23,81	
		MFD								
	1.8 TDCi	ABO	05.01-05.05	85			RLE	F 026 003 701	23,81	
			08.02-05.05	74			JBH,LLE	F 026 003 608	23,81	
							RLE	F 026 003 701	23,81	
		ABS,	08.02-05.05	74				0 204 123 701	23,81	
		OFD								
	1.8 TDDi	ABO	01.99-05.05	66			JBH,LLE	F 026 003 608	23,81	
							RLE	F 026 003 701	23,81	
			08.99-05.05	55			JBH,LLE	F 026 003 608	23,81	
							RLE	F 026 003 701	23,81	
		ABS,	01.99-10.00	66				F 026 003 701	23,81	
		OFD	08.99-10.00	55				F 026 003 701	23,81	
			11.00-05.05	55				0 204 123 701	23,81	
				66				0 204 123 701	23,81	
	2.0 i	ABO	11.98-05.05	96			JBH,LLE	F 026 003 608	23,81	
							RLE	F 026 003 701	23,81	
		ABS,	11.98-10.01	96			JBH	0 986 481 000	23,81	
		MFD								



		S							
2.0i		ABS, 11.98-10.00	96				F 026 003 701		23,81
		OFD 11.00-05.05	96				0 204 123 701		23,81
2.0i ST170		ABO 02.02-05.05	127			JBH, LLE	F 026 003 608		23,81
						RLE	F 026 003 701		23,81
		ABS, 02.02-05.05	127				0 204 123 701		23,81
		OFD							
	1.4i	11.98-05.05	55				0 986 486 066		19,05
	1.6i, i FFV	11.98-05.05	72/74-77				0 986 486 066		19,05
	1.8i, TDCi, TDDi	11.98-05.05	55/66/74/85				0 986 486 066		19,05
	2.0i, i ST170	11.98-05.05	96/127				0 986 486 066		19,05
Focus I [99]									
	1.4i	ABO 08.98-05.05	55			JBH, LLE	F 026 003 608		23,81
						RLE	F 026 003 701		23,81
		ABS, 08.98-10.01	55			JBH	0 986 481 000		23,81
		MFD							
		ABS, 08.98-10.00	55				F 026 003 701		23,81
		OFD 11.00-05.05	55				0 204 123 701		23,81
	1.6i	ABO 08.98-05.05	74			JBH, LLE	F 026 003 608		23,81
						RLE	F 026 003 701		23,81
		09.02-05.05	72			JBH, LLE	F 026 003 608		23,81
						RLE	F 026 003 701		23,81
		ABS, 08.98-10.00	74				F 026 003 701		23,81
		OFD 11.00-05.05	74				0 204 123 701		23,81
		09.02-05.05	72				0 204 123 701		23,81
	1.6i FFV	ABO 10.01-05.05	74-77			JBH, LLE	F 026 003 608		23,81
						RLE	F 026 003 701		23,81
		ABS, 10.01-05.05	74-77				0 204 123 701		23,81
		OFD							
	1.6i, i FFV	ABS, 08.98-10.01	74-77			JBH	0 986 481 000		23,81
		MFD							
	1.8i	ABO 08.98-05.05	85			RLE	F 026 003 701		23,81
		ABS, 08.98-10.00	85				F 026 003 701		23,81
		OFD							
	1.8i	ABO 08.98-05.05	85			JBH, LLE	F 026 003 608		23,81
	1.8 TDCi	ABS, 11.00-05.05	85				0 204 123 701		23,81
		OFD							
	1.8i, TDCi, TDDi	ABS, 08.98-10.01	55/66/85			JBH	0 986 481 000		23,81
		MFD							
	1.8 TDCi	ABO 05.01-05.05	85			RLE	F 026 003 701		23,81
		08.02-05.05	74			JBH, LLE	F 026 003 608		23,81
						RLE	F 026 003 701		23,81
		ABS, 08.02-05.05	74				0 204 123 701		23,81
		OFD							
	1.8 TDDi	ABO 01.99-05.05	55			JBH, LLE	F 026 003 608		23,81
						RLE	F 026 003 701		23,81
			66			JBH, LLE	F 026 003 608		23,81
						RLE	F 026 003 701		23,81
		ABS, 01.99-10.00	55				F 026 003 701		23,81
		OFD	66				F 026 003 701		23,81
		11.00-05.05	55				0 204 123 701		23,81
			66				0 204 123 701		23,81
	2.0i	ABO 08.98-05.05	96			JBH, LLE	F 026 003 608		23,81
						RLE	F 026 003 701		23,81
		ABS, 08.98-10.01	96			JBH	0 986 481 000		23,81
		MFD							
		ABS, 08.98-10.00	96				F 026 003 701		23,81
		OFD 11.00-05.05	96				0 204 123 701		23,81
	2.0i RS	ABO 02.02-05.05	127/158			JBH, LLE	F 026 003 608		23,81
	2.0i ST170					RLE	F 026 003 701		23,81



		S							
	◀ FORD Focus I [99]								
	2.0 iRS	ABS,	02.02-05.05	127/158			0 204 123 701	23,81	
	2.0 iST170	OFD							
	1.4 i		08.98-05.05	55			0 986 486 066	19,05	
	1.6 i, iFFV		08.98-05.05	72/74-77			0 986 486 066	19,05	
	1.8 i, TDCi, TDDi		08.98-05.05	55/66/74/85			0 986 486 066	19,05	
	2.0 i, iRS, iST170		08.98-05.05	96/127/158			0 986 486 066	19,05	
Focus II Cabriolet [06]									
	1.6 i	ABS	07.06-05.07	74		JBH	0 986 480 994	23,81	
	2.0 i, TDCi	ABS	07.06-05.07	100/107		JBH	0 986 480 994	23,81	
	1.6 i		07.06-07.10	74		LLE	0 986 486 150	19,05	
	2.0 i, TDCi		07.06-07.10	100/107		LLE	0 986 486 150	19,05	
	1.6 i		07.06-07.10	74			0 986 486 611	28	
Focus II Turnier [04]									
	1.4 i	ABS	07.04-05.07	59		JBH	0 986 480 994	23,81	
		ABS,	06.07-01.08	59		JBH	0 986 480 994	23,81	
		MFD							
	1.6 i	ABS	07.04-05.07	74		JBH	0 986 480 994	23,81	
		ABS,	06.07-01.08	74		JBH	0 986 480 994	23,81	
		MFD							
	1.6 TDCi	ABS	07.04-05.07	66		JBH	0 986 480 994	23,81	
				74-80		JBH	0 986 480 994	23,81	
		ABS,	06.07-01.08	66		JBH	0 986 480 994	23,81	
		MFD		74-80		JBH	0 986 480 994	23,81	
	1.6 Ti-VCT	ABS	07.04-05.07	85		JBH	0 986 480 994	23,81	
		ABS,	06.07-01.08	85		JBH	0 986 480 994	23,81	
		MFD							
	1.8 FFV	ABS	05.05-05.07	92		JBH	0 986 480 994	23,81	
		ABS,	06.07-01.08	92		JBH	0 986 480 994	23,81	
		MFD							
	1.8 i	ABS	05.05-05.07	92		JBH	0 986 480 994	23,81	
		ABS,	06.07-01.08	92		JBH	0 986 480 994	23,81	
		MFD							
	1.8 TDCi	ABS	04.05-05.07	85		JBH	0 986 480 994	23,81	
		ABS,	06.07-01.08	85		JBH	0 986 480 994	23,81	
		MFD							
	2.0 i	ABS	07.04-05.07	107		JBH	0 986 480 994	23,81	
		ABS,	06.07-01.08	107		JBH	0 986 480 994	23,81	
		MFD							
	2.0 TDCi	ABS	07.04-05.07	98-100		JBH	0 986 480 994	23,81	
		ABS,	06.07-01.08	98-100		JBH	0 986 480 994	23,81	
		MFD							
	1.4 i		07.04-01.08	59		LLE	0 986 486 150	19,05	
	1.6 i, TDCi, Ti-VCT		07.04-01.08	66/74-80/85		LLE	0 986 486 150	19,05	
	1.8 FFV, i, TDCi		04.05-01.08	85/92		LLE	0 986 486 150	19,05	
	2.0 i, TDCi		07.04-01.08	98-100/107		LLE	0 986 486 150	19,05	
	1.4 i		02.06-01.08	59			0 986 486 611	28	
	1.6 i, Ti-VCT		02.06-01.08	74/85			0 986 486 611	28	
	1.8 FFV, i		02.06-01.08	92	Get.-Nr. B5/IB5		0 986 486 611	28	



Focus II Turnier [08]

	1.4 i	12.07-12.11	59		LLE	0 986 486 150 19,05
	1.6 i , TDCi, Ti-VCT	12.07-12.11	66/74-80/85-88		LLE	0 986 486 150 19,05
	1.8 Flexifuel, i, TDCi	12.07-12.11	85/92		LLE	0 986 486 150 19,05
	2.0 i , LPG, TDCi	12.07-12.11	81/100/104-107		LLE	0 986 486 150 19,05
	1.4 i	12.07-12.11	59			0 986 486 611 28
	1.6 i , Ti-VCT	12.07-12.11	74/85-88			0 986 486 611 28
	1.8 Flexifuel, i	12.07-12.11	92			0 986 486 611 28

Focus II [04]

	1.4 i	ABS 07.04-05.07	59		JBH	0 986 480 994 23,81	
		ABS, 06.07-01.08	59		JBH	0 986 480 994 23,81	
		MFD					
	1.6 i	ABS 07.04-05.07	74		JBH	0 986 480 994 23,81	
		ABS, 06.07-01.08	74		JBH	0 986 480 994 23,81	
		MFD					
	1.6 TDCi	ABS 07.04-05.07	66		JBH	0 986 480 994 23,81	
			74-80		JBH	0 986 480 994 23,81	
			80		JBH	0 986 480 994 23,81	
		ABS, 06.07-01.08	66		JBH	0 986 480 994 23,81	
		MFD	74-80		JBH	0 986 480 994 23,81	
			80		JBH	0 986 480 994 23,81	
	1.6 Ti-VCT	ABS 07.04-05.07	85		JBH	0 986 480 994 23,81	
		ABS, 06.07-01.08	85		JBH	0 986 480 994 23,81	
		MFD					
	1.8 FFV	ABS 07.04-05.07	92		JBH	0 986 480 994 23,81	
		ABS, 06.07-01.08	92		JBH	0 986 480 994 23,81	
		MFD					
	1.8 i	ABS 05.05-05.07	92		JBH	0 986 480 994 23,81	
		ABS, 06.07-01.08	92		JBH	0 986 480 994 23,81	
		MFD					
	1.8 TDCi	ABS 04.05-05.07	85		JBH	0 986 480 994 23,81	
ABS, 06.07-01.08		85		JBH	0 986 480 994 23,81		
MFD							
2.0 i	ABS 07.04-05.07	107		JBH	0 986 480 994 23,81		
	ABS, 06.07-01.08	107		JBH	0 986 480 994 23,81		
	MFD						
2.0 TDCi	ABS 07.04-05.07	98-100		JBH	0 986 480 994 23,81		
	ABS, 06.07-01.08	98-100		JBH	0 986 480 994 23,81		
	MFD						
2.5 i ST		10.05-01.08	166		JBH	0 986 480 994 23,81	
	1.4 i	07.04-01.08	59		LLE	0 986 486 150 19,05	
	1.6 i , TDCi, Ti-VCT	07.04-01.08	66/74-80/85		LLE	0 986 486 150 19,05	
	1.8 FFV, i, TDCi	07.04-01.08	85/92		LLE	0 986 486 150 19,05	
	2.0 i , TDCi	07.04-01.08	98-100/107		LLE	0 986 486 150 19,05	
	1.4 i	02.06-01.08	59			0 986 486 611 28	
	1.6 i , Ti-VCT	02.06-01.08	74/85			0 986 486 611 28	
	1.8 FFV, i	02.06-01.08	92	Get.-Nr. B5/IB5		0 986 486 611 28	

Focus II [08]

	1.4 i	12.07-12.11	59		LLE	0 986 486 150 19,05
	1.6 i , TDCi, Ti-VCT	12.07-12.11	66/74-80/85-88		LLE	0 986 486 150 19,05
	1.8 Flexifuel, i, TDCi	12.07-12.11	85/92		LLE	0 986 486 150 19,05



		S							
◀ FORD Focus II [08]									
		2.0 CNG, i, LPG, TDCi	12.07-12.11	81/93-107		LLE	0986 486 150	19,05	
		1.4 i	12.07-12.11	59			0986 486 611	28	
		1.6 i, Ti-VCT	12.07-12.11	74/85-88			0986 486 611	28	
		1.8 Flexifuel, i	12.07-12.11	92			0986 486 611	28	
Focus III Turnier [11]									
		1.6 EcoBoost	01.11→	110/134		LLE,SSJ	0986 486 150	19,05	
		1.6 TDCi	01.11-12.13	70		LLE,SSJ	0986 486 150	19,05	
				85		LLE,SSJ	0986 486 150	19,05	
		1.6 TDCi EONetic	06.12-12.13	77		LLE,SSJ	0986 486 150	19,05	
		1.6 Ti-VCT	01.11-12.13	77		LLE	0986 486 150	19,05	
			02.12-12.13	63		LLE	0986 486 150	19,05	
		1.6 Ti-VCT, Ti-VCT FlexiFuel	01.11-12.13	86-88/92		LLE	0986 486 150	19,05	
		2.0 GDI Ti-VCT, TDCi	01.11-12.13	100/103/110/120		LLE	0986 486 150	19,05	
Focus III [11]									
		1.6 EcoBoost	01.11→	110/134		LLE,SSJ	0986 486 150	19,05	
		1.6 TDCi	01.11-12.13	70		LLE,SSJ	0986 486 150	19,05	
				85		LLE,SSJ	0986 486 150	19,05	
		1.6 TDCi EONetic	06.12-12.13	77		LLE,SSJ	0986 486 150	19,05	
		1.6 Ti-VCT	01.11-12.13	77		LLE	0986 486 150	19,05	
			08.11-12.13	63		LLE	0986 486 150	19,05	
		1.6 Ti-VCT, Ti-VCT FlexiFuel	01.11-12.13	86-88/92		LLE	0986 486 150	19,05	
		2.0 GDI Ti-VCT, TDCi	01.11-12.13	100/103/110-125		LLE	0986 486 150	19,05	
Focus Sedan									
		1.8 D Turbo	09.00→	66		JBH	F 026 003 608	23,81	
Focus Sedan [Fase I]									
		1.6 i 8V	03.04→	75		JBH	F 026 003 608	23,81	
		1.8 i 16V	ABO 09.00-07.04	85		JBH	F 026 003 608	23,81	
			ABS 09.00-07.04	85			0204 123 701	23,81	
		2.0 i 16V	ABO 07.00-09.08	96-97/103-108		JBH	F 026 003 608	23,81	
			ABS 07.00-09.08	96-97/103-108			0204 123 701	23,81	
Fusion [02]									
		1.4 i	ABO 10.02-06.12	50/56-59		LLE	0986 481 063	23,81	
		1.4 TDCi	ABS, 10.02-06.12	50/56-59		LLE	0986 481 061	23,81	
			MFD						
			ABS, 10.02-06.12	50/56-59		LLE	0986 481 062	23,81	
			OFD						
		1.6 i	ABO 10.02-06.12	66/74		LLE	0986 481 063	23,81	
		1.6 TDCi	ABS, 10.02-06.12	66/74		LLE	0986 481 061	23,81	
			MFD						
			ABS, 10.02-06.12	66/74		LLE	0986 481 062	23,81	
			OFD						
		1.25 i	ABO 03.05-06.12	55		LLE	0986 481 063	23,81	
			ABS, 03.05-06.12	55		LLE	0986 481 061	23,81	
			MFD						
			ABS, 03.05-06.12	55		LLE	0986 481 062	23,81	
			OFD						





Galaxy [00]



	1.9 TDI	OFD	04.00-10.02	66/85	JBH	0 986 481 047	
			11.02-08.06	66/85	JBH,RLE	0 986 481 047	
			01.03-08.06	96/110	JBH,RLE	0 986 481 047	
	2.0i	OFD	01.01-10.02	85	JBH	0 986 481 047	
			11.02-08.06	85	JBH,RLE	0 986 481 047	
	2.3i	OFD	04.00-10.02	107	JBH	0 986 481 047	
			11.02-08.06	103	JBH,RLE	0 986 481 047	
				107	JBH,RLE	0 986 481 047	
	2.8i	OFD	04.00-10.02	150	JBH	0 986 481 047	
			11.02-08.06	150	JBH,RLE	0 986 481 047	

	1.9 TDI		04.00-08.06	66/85/96/110		0 986 486 050	19,05
	2.0i		01.01-08.06	85		0 986 486 050	19,05
	2.3i		04.00-08.06	103/107		0 986 486 050	19,05
	2.8i		04.00-08.06	150		0 986 486 050	19,05

	1.9 TDI		04.00-08.06	66/85/96/110		0 986 486 595	29
	2.0i		01.01-08.06	85		F 026 A06 033	
	2.3i		04.00-08.06	103/107		F 026 A06 033	
	2.8i		04.00-08.06	150		0 986 486 595	29

Galaxy [95]



	1.9 TDI	ABO	02.95-08.97	66	JBH	0 986 480 930	23,81
		ABS	02.95-08.97	66	JBH	0 986 480 933	23,81
			09.97-03.00	66	JBH	0 986 481 047	
			11.97-03.00	81	JBH	0 986 481 047	
	2.0i	ABO	02.95-08.97	85	JBH	0 986 480 930	23,81
		ABS	02.95-08.97	85	JBH	0 986 480 933	23,81
			09.97-03.00	85	JBH	0 986 481 047	
	2.3i 16V	ABO	01.97-08.97	107	JBH	0 986 480 930	23,81
		ABS	01.97-08.97	107	JBH	0 986 480 933	23,81
			09.97-03.00	107	JBH	0 986 481 047	
	2.8i	ABO	02.95-08.97	128	JBH	0 986 480 930	23,81
		ABS	02.95-08.97	128	JBH	0 986 480 933	23,81
	2.8i 4x4		09.97-03.00	128	JBH	0 986 481 047	

	1.9 TDI		02.95-03.00	66/81		0 986 486 050	19,05
	2.0i		02.95-03.00	85		0 986 486 050	19,05
	2.3i 16V		01.97-03.00	107		0 986 486 050	19,05
	2.8i		02.95-03.00	128		0 986 486 050	19,05

	2.0i		02.95-03.00	85		F 026 A06 033	
	2.3i 16V		01.97-03.00	107		F 026 A06 033	
	2.8i, i 4x4		02.95-03.00	128		F 026 A06 033	

Ka [Fase I]





















	1.0i		01.97-07.99	39	JBH	0 986 BB3 255	22,22
			08.99-12.07	48	JBH	0 986 BB3 256	20,64
	1.3i		01.97-08.99	44	JBH	0 986 BB3 255	22,22
						0 986 480 919	20,6



		S				?			
◀ FORD									
Ka [08]									
	1.2		09.08→	51			0 265	232 237^B	
	1.3 TDCi		09.08→	55			0 265	232 237^B	
	1.2		09.08→	51			0 265	005 823	
	1.3 TDCi		09.08→	55			0 265	005 823	
Ka [97]									
	1.3 i	ABO	09.96-09.99	36/37/44		AS3,JBH	0 986	480 919	20,6
		ABS	01.97-09.08	36/37/44/51			0 986	480 927	22,2
	1.3 i		11.98-09.08	36/37/44/51			0 986	486 067	19,05
	1.6 i		07.03-09.08	70			0 986	486 067	19,05
Kuga [08]									
	2.0 TDCi		02.08-11.12	100/103/		LLE	0 986	486 150	19,05
	2.0 TDCi 4x4			120-123					
Kuga [13]									
	2.0 TDCi, TDCi 4x4		11.12-09.14	100/103/120		LLE	0 986	486 150	19,05
Maverick [UDS, UNS]									
	2.4 i		06.93-04.96	91			0 986	480 952	23,8
		ABS	05.96-12.98	85/87		JBH	0 986	480 860	
	2.7 TD		06.93-04.96	74			0 986	480 952	23,8
		ABS	05.96-12.98	92		JBH	0 986	480 860	
Mondeo									
	1.8 D Turbo, i	ABO	11.97-07.01	66/85			0 204	123 482	25,4
	2.0 i	ABO	11.97-07.01	97			0 204	123 482	25,4
	2.5 i		02.98-12.01	125			0 204	123 548	25,4
	1.8 D Turbo, i	ABO	11.97-07.01	66/85		RLE	0 204	125 499	
	2.0 i	ABO	11.97-07.01	97		RLE	0 204	125 499	
	2.5 i		03.04-01.08	127			0 265	222 031^B	
	2.5 i		03.04-01.08	127			0 265	005 236	
Mondeo I Turnier [93]									
	1.6 i	ABO	02.96-07.96	65/66			0 204	123 482	25,4
		ABS	04.93-07.96	65/66			0 204	123 194	25,4



		S							
1.8i		ABO	02.96-07.96	65/82/85			0 204 123 482	25,4	
1.8TD		ABS	04.93-07.96	65/82/85			0 204 123 194	25,4	
2.0i		ABO	02.96-07.96	97-100			0 204 123 482	25,4	
2.0i 4x4		ABS	04.93-07.96	97-100			0 204 123 194	25,4	
2.5i		ABO	02.96-07.96	125			0 204 123 482	25,4	
		ABS	08.94-07.96	125			0 204 123 194	25,4	
	1.6i		02.96-07.96	65/66		LLE	0 204 125 500		
						RLE	0 204 125 499		
	1.8i		02.96-07.96	65/82/85		LLE	0 204 125 500		
	1.8TD					RLE	0 204 125 499		
	2.0i		02.96-07.96	97-100		LLE	0 204 125 500		
	2.0i 4x4					RLE	0 204 125 499		
	2.5i		02.96-07.96	125		LLE	0 204 125 500		
						RLE	0 204 125 499		
	1.6i		04.93-07.96	65/66			0 986 486 055	19,05	
	1.8i, TD		04.93-07.96	65/82/85			0 986 486 055	19,05	
	2.0i, i 4x4		04.93-07.96	97-100			0 986 486 055	19,05	
	2.5i		08.94-07.96	125			0 986 486 055	19,05	
	1.6i		04.93-07.96	65/66			F 026 A06 033		
	1.8i, TD		04.93-07.96	65/82/85			F 026 A06 033		
	2.0i, i 4x4		04.93-07.96	97-100			F 026 A06 033		
Mondeo I [93]									
									
	1.6i	ABO	02.96-07.96	65/66			0 204 123 482	25,4	
		ABS	01.93-07.96	65/66			0 204 123 194	25,4	
	1.8i, i 4x4, TD	ABO	02.96-07.96	65/82/85			0 204 123 482	25,4	
		ABS	01.93-07.96	65/82/85			0 204 123 194	25,4	
	2.0i	ABO	02.96-07.96	97-100			0 204 123 482	25,4	
	2.0i 4x4	ABS	01.93-07.96	97-100			0 204 123 194	25,4	
	2.5i	ABO	02.96-07.96	125			0 204 123 482	25,4	
		ABS	08.94-07.96	125			0 204 123 194	25,4	
	1.6i		02.96-07.96	65/66		LLE	0 204 125 500		
						RLE	0 204 125 499		
	1.8i, i 4x4, TD		02.96-07.96	65/82/85		LLE	0 204 125 500		
						RLE	0 204 125 499		
	2.0i		02.96-07.96	97-100		LLE	0 204 125 500		
	2.0i 4x4					RLE	0 204 125 499		
	2.5i		02.96-07.96	125		LLE	0 204 125 500		
						RLE	0 204 125 499		
	1.6i		01.93-07.96	65/66			0 986 486 055	19,05	
	1.8i, i 4x4, TD		01.93-07.96	65/82/85			0 986 486 055	19,05	
	2.0i, i 4x4		01.93-07.96	97-100			0 986 486 055	19,05	
	2.5i		08.94-07.96	125			0 986 486 055	19,05	
	1.6i		01.93-07.96	65/66			F 026 A06 033		
	1.8i, i 4x4, TD		01.93-07.96	65/82/85			F 026 A06 033		
	2.0i, i 4x4		01.93-07.96	97-100			F 026 A06 033		
Mondeo I [97]									
									
	1.6i	ABO	08.98-09.00	70			0 204 123 482	25,4	
		ABS	08.98-09.00	70			0 204 123 548	25,4	



		S								
◀ FORD Mondeo I [97]										
	1.6 i	ABO	08.98-09.00	70			LLE	0 204 125 500		
							RLE	0 204 125 499		
		ABS	08.98-09.00	70				LLE	0 204 125 491	
								RLE	0 204 125 492	
	1.6 i		08.98-09.00	70			0 986 486 055	19,05		
	1.6 i		08.98-09.00	70			0 265 216 701 ^B			
							0 265 220 495 ^F			
Mondeo II Turnier [97]										
	1.6 i	ABO	08.96-09.00	65-66/70			LLE	0 204 123 482	25,4	
							RLE	0 204 123 548	25,4	
	1.8 i	ABO	08.96-09.00	66/85				LLE	0 204 123 482	25,4
								RLE	0 204 123 548	25,4
	1.8 TD	ABS	08.96-09.00	66/85				LLE	0 204 123 482	25,4
								RLE	0 204 123 548	25,4
	2.0 i	ABO	08.96-09.00	96				LLE	0 204 123 482	25,4
								RLE	0 204 123 548	25,4
	2.5 i	ABO	08.96-09.00	125/151				LLE	0 204 123 482	25,4
								RLE	0 204 123 548	25,4
	2.5 iST200	ABS	08.96-09.00	125/151				LLE	0 204 123 482	25,4
								RLE	0 204 123 548	25,4
	1.6 i	ABO	08.96-09.00	65-66/70			LLE	0 204 125 500		
							RLE	0 204 125 499		
	1.8 i	ABO	08.96-09.00	66/85				LLE	0 204 125 491	
								RLE	0 204 125 492	
	1.8 TD	ABS	08.96-09.00	66/85				LLE	0 204 125 500	
								RLE	0 204 125 499	
	2.0 i	ABO	08.96-09.00	96				LLE	0 204 125 491	
								RLE	0 204 125 492	
	2.5 i	ABO	08.96-09.00	125/151				LLE	0 204 125 500	
								RLE	0 204 125 499	
	2.5 iST200	ABS	08.96-09.00	125/151				LLE	0 204 125 491	
								RLE	0 204 125 492	
	1.6 i		08.96-09.00	65-66/70			0 986 486 055	19,05		
							0 986 486 055	19,05		
							0 986 486 055	19,05		
							0 986 486 055	19,05		
	1.6 i		12.97-08.98	65-66			BO	0 265 220 495 ^F		
			08.98-09.00	70				0 265 216 701 ^B		
	1.8 i		12.97-09.00	85			BO	0 265 220 495 ^F		
			08.98-09.00	85				0 265 216 701 ^B		
	1.8 TD		12.97-09.00	66			BO	0 265 220 495 ^F		
			08.98-09.00	96				0 265 216 701 ^B		
	2.0 i		12.97-09.00	66			BO	0 265 216 701 ^B		
			08.98-09.00	96				0 265 220 495 ^F		
	2.5 i		12.97-09.00	125			BO	0 265 216 701 ^B		
			08.98-09.00	96				0 265 220 495 ^F		
	2.5 iST200		09.99-09.00	151			BO	0 265 216 701 ^B		
								0 265 220 495 ^F		





Mondeo II [97]



	1.6 i	ABO 08.96-09.00 65-66/70		0 204 123 482	25,4
		ABS 08.96-09.00 65-66/70		0 204 123 548	25,4
	1.8 i	ABO 08.96-09.00 65-66/85		0 204 123 482	25,4
		ABS 08.96-09.00 65-66/85		0 204 123 548	25,4
	2.0 i	ABO 08.96-09.00 96		0 204 123 482	25,4
		ABS 08.96-09.00 96		0 204 123 548	25,4
	2.5 i	ABO 08.96-09.00 125/151		0 204 123 482	25,4
		ABS 08.96-09.00 125/151		0 204 123 548	25,4

	1.6 i	ABO 08.96-09.00 65-66/70	LLE	0 204 125 500	
			RLE	0 204 125 499	
	1.8 i	ABO 08.96-09.00 65-66/85	LLE	0 204 125 500	
			RLE	0 204 125 499	
	2.0 i	ABO 08.96-09.00 96	LLE	0 204 125 500	
			RLE	0 204 125 499	
	2.5 i	ABO 08.96-09.00 125/151	LLE	0 204 125 500	
			RLE	0 204 125 499	

	1.6 i	08.96-09.00 65-66/70		0 986 486 055	19,05
	1.8 i, TD	08.96-09.00 65-66/85		0 986 486 055	19,05
	2.0 i	08.96-09.00 96		0 986 486 055	19,05
	2.5 i, i ST200	08.96-09.00 125/151		0 986 486 055	19,05

	1.6 i	12.97-08.98 65-66	BO	0 265 216 701^B	
		08.98-09.00 70		0 265 220 495^F	
	1.8 i	12.97-09.00 85	BO	0 265 216 701^B	
		08.98-09.00 85		0 265 220 495^F	
	2.0 i	12.97-09.00 96	BO	0 265 216 701^B	
		08.98-09.00 96		0 265 220 495^F	
	2.5 i	12.97-09.00 125	BO	0 265 216 701^B	
		09.99-09.00 151		0 265 220 495^F	

Mondeo III Turnier [01]













	1.8 i	10.00-02.02 81/92	TW	0 204 123 578	23,81
		10.00-03.07 81/92	BSS	0 204 788 361	23,81
		06.03-03.07 96	BSS	0 204 779 135	23,81
			BSS	0 204 788 361	23,81





Model	Period	Power	Code	Price	Price
◀ FORD Mondeo III Turnier [01]					
2.0 i	10.00-02.02	66/85/96/107	TW	0 204 123 578	23,81
2.0 TDCi	10.00-03.07	66/85/96/	BSS	0 204 788 361	23,81
2.0 TDDi		107	BSS	0 204 779 135	23,81
2.2 TDCi	08.04-03.07	110-114	BSS	0 204 788 361	23,81
			BSS	0 204 779 135	23,81
2.5 i	10.00-02.02	125	TW	0 204 123 578	23,81
	10.00-03.07	125	BSS	0 204 788 361	23,81
			BSS	0 204 779 135	23,81
3.0 i	08.04-03.07	150	BSS	0 204 788 361	23,81
			BSS	0 204 779 135	23,81
3.0 i ST220	02.02-02.02	166	TW	0 204 123 578	23,81
	02.02-03.07	166	BSS	0 204 788 361	23,81
			BSS	0 204 779 135	23,81
1.8 i	03.02-03.07	81	BSS, LLE	0 204 125 846	
		92	BSS, LLE	0 204 125 845	
			BSS, LLE	0 204 125 846	
			BSS, LLE	0 204 125 845	
	06.03-03.07	96	BSS, LLE	0 204 125 846	
			BSS, LLE	0 204 125 845	
	MFD 03.02-03.07	81	LLE	0 204 125 845	
		92	LLE	0 204 125 845	
	06.03-03.07	96	LLE	0 204 125 845	
	OFD 03.02-03.07	81	LLE	0 204 125 846	
		92	LLE	0 204 125 846	
	06.03-03.07	96	LLE	0 204 125 846	
2.0 i	03.02-03.07	107	BSS, LLE	0 204 125 846	
			BSS, LLE	0 204 125 845	
	MFD 03.02-03.07	107	LLE	0 204 125 845	
	OFD 03.02-03.07	107	LLE	0 204 125 846	
2.0 TDCi	03.02-03.07	96	BSS, LLE	0 204 125 846	
			BSS, LLE	0 204 125 845	
	09.02-03.07	85	BSS, LLE	0 204 125 846	
			BSS, LLE	0 204 125 845	
	04.06-03.07	66	BSS, LLE	0 204 125 846	
			BSS, LLE	0 204 125 845	
	MFD 03.02-03.07	96	LLE	0 204 125 845	
	09.02-03.07	85	LLE	0 204 125 845	
	04.06-03.07	66	LLE	0 204 125 845	
	OFD 03.02-03.07	96	LLE	0 204 125 846	
	09.02-03.07	85	LLE	0 204 125 846	
	04.06-03.07	66	LLE	0 204 125 846	
2.0 TDDi	03.02-08.02	85	BSS, LLE	0 204 125 846	
			BSS, LLE	0 204 125 845	
	03.02-03.07	66	BSS, LLE	0 204 125 846	
			BSS, LLE	0 204 125 845	
	MFD 03.02-08.02	85	LLE	0 204 125 845	
	03.02-03.07	66	LLE	0 204 125 845	
	OFD 03.02-08.02	85	LLE	0 204 125 846	
	03.02-03.07	66	LLE	0 204 125 846	
2.2 TDCi	08.04-03.07	110-114	BSS, LLE	0 204 125 846	
			BSS, LLE	0 204 125 845	
	MFD 08.04-03.07	110-114	LLE	0 204 125 845	
	OFD 08.04-03.07	110-114	LLE	0 204 125 846	
2.5 i	03.02-03.07	125	BSS, LLE	0 204 125 846	
			BSS, LLE	0 204 125 845	
	MFD 03.02-03.07	125	LLE	0 204 125 845	
	OFD 03.02-03.07	125	LLE	0 204 125 846	
3.0 i	08.04-03.07	150	BSS, LLE	0 204 125 846	
			BSS, LLE	0 204 125 845	
	MFD 08.04-03.07	150	LLE	0 204 125 845	
	OFD 08.04-03.07	150	LLE	0 204 125 846	



		S							
3.0i ST220		03.02-03.07	166			BSS,LLE	0 204 125 846		
						BSS,LLE	0 204 125 845		
		MFD 03.02-03.07	166			LLE	0 204 125 845		
		OFD 03.02-03.07	166			LLE	0 204 125 846		
	1.8i	10.00-03.07	81/92				F 026 A06 033		
	2.0i	10.00-03.07	107				F 026 A06 033		
	2.0 TDCi	10.01-03.07	96	Get.-Nr. MMT6			0 986 486 610	31	
				Get.-Nr. MTX75			F 026 A06 033		
		09.02-03.07	85	Get.-Nr. MMT6			0 986 486 610	31	
				Get.-Nr. MTX75			F 026 A06 033		
	2.0 TDCi, TDDi	10.00-03.07	66				F 026 A06 033		
	2.0 TDDi	10.00-08.02	85				F 026 A06 033		
	2.2 TDCi	08.04-03.07	110-114				0 986 486 610	31	
	2.5i	06.03-03.07	125	Get.-Nr. MMT6	MG6		0 986 486 610	31	
	3.0i	08.04-03.07	150				0 986 486 610	31	
	3.0i ST220	02.02-03.07	166	Get.-Nr. MTX75			F 026 A06 033		
		06.03-03.07	166	Get.-Nr. MMT6			0 986 486 610	31	
	1.8i	10.00-02.03	81				0 265 225 267 ^T		
			92				0 265 225 267 ^T		
		10.00-08.04	81				0 265 222 031 ^B		
			92				0 265 222 031 ^B		
		03.03-09.03	81				0 265 225 267 ^T		
			92				0 265 225 267 ^T		
		06.03-09.03	96				0 265 225 267 ^T		
		06.03-08.04	96				0 265 222 031 ^B		
		10.03-08.04	81				0 265 225 170 ^T		
			92				0 265 225 170 ^T		
			96				0 265 225 170 ^T		
		09.04-03.07	81				0 265 225 340 ^T		
			92				0 265 231 463 ^B		
			96				0 265 225 340 ^T		
			96				0 265 231 463 ^B		
			96				0 265 225 340 ^T		
			96				0 265 231 463 ^B		
	2.0i	10.00-09.03	107				0 265 225 267 ^T		
		10.00-08.04	107				0 265 222 031 ^B		
		10.03-08.04	107				0 265 225 170 ^T		
		09.04-03.07	107				0 265 225 340 ^T		
							0 265 231 463 ^B		
	2.0 TDCi	10.01-02.03	96				0 265 225 267 ^T		
		10.01-08.04	96				0 265 222 031 ^B		
		09.02-09.03	85				0 265 225 267 ^T		
		03.03-09.03	96				0 265 225 267 ^T		
		10.03-08.04	85				0 265 225 170 ^T		
			96				0 265 225 170 ^T		
		09.04-06.06	85				0 265 225 340 ^T		
			96				0 265 225 340 ^T		
		09.04-03.07	85				0 265 231 463 ^B		
			96				0 265 231 463 ^B		
		07.06-03.07	85				0 265 225 395 ^T		
			96				0 265 225 395 ^T		
	2.0 TDCi	10.00-08.04	85				0 265 222 031 ^B		
	2.0 TDDi	09.04-06.06	66				0 265 225 340 ^T		
		09.04-03.07	66				0 265 231 463 ^B		
		07.06-03.07	66				0 265 225 395 ^T		
	2.0 TDDi	10.00-08.02	85				0 265 225 267 ^T		
		10.00-09.03	66				0 265 225 267 ^T		
		10.00-08.04	66				0 265 222 031 ^B		
		10.03-08.04	66				0 265 225 170 ^T		
	2.2 TDCi	08.04-08.04	110-114				0 265 222 031 ^B		
							0 265 225 170 ^T		





FORD Mondeo III Turnier [01]

2.2 TDCi	09.04-06.06	110-114	0 265 225 340 ^T
	09.04-03.07	110-114	0 265 231 463 ^B
	07.06-03.07	110-114	0 265 225 395 ^T
2.5 i	10.00-09.03	125	0 265 225 267 ^T
	10.00-08.04	125	0 265 222 031 ^B
	10.03-08.04	125	0 265 225 170 ^T
	09.04-03.07	125	0 265 225 340 ^T
3.0 i	08.04-08.04	150	0 265 222 031 ^B
	09.04-03.07	150	0 265 225 170 ^T
			0 265 231 463 ^B
3.0 i ST220	02.02-09.03	166	0 265 225 267 ^T
	02.02-08.04	166	0 265 222 031 ^B
	10.03-08.04	166	0 265 225 170 ^T
	09.04-03.07	166	0 265 225 340 ^T

1.8 i	10.00-08.04	81/92/96	0 265 005 236
	09.04-03.07	81/92/96	0 265 005 639
2.0 i, TDCi	09.04-03.07	85/96/107	0 265 005 639
2.0 i, TDCi, TDDi	10.00-08.04	85/96/107	0 265 005 236
2.0 TDCi, TDDi	09.04-03.07	66	0 265 005 639
2.0 TDDi	10.00-08.04	66	0 265 005 236
2.2 TDCi	08.04-08.04	110-114	0 265 005 236
	09.04-03.07	110-114	0 265 005 639
2.5 i	10.00-08.04	125	0 265 005 236
	09.04-03.07	125	0 265 005 639
3.0 i	02.02-08.04	150/166	0 265 005 236
3.0 i ST220	09.04-03.07	150/166	0 265 005 639

1.8 i	10.00-03.07	81/92/96	0 265 005 414
	10.00-03.07	66/85/96/107	0 265 005 414
2.2 TDCi	08.04-03.07	110-114	0 265 005 414
2.5 i	10.00-03.07	125	0 265 005 414
3.0 i, i ST220	02.02-03.07	150/166	0 265 005 414

1.8 i	10.00-03.07	81/92/96	0 265 005 303
	10.00-03.07	66/85/96/107	0 265 005 303
2.2 TDCi	08.04-03.07	110-114	0 265 005 303
2.5 i	10.00-03.07	125	0 265 005 303
3.0 i, i ST220	02.02-03.07	150/166	0 265 005 303

Mondeo III [01]

1.8 i	10.00-02.02	81/92	TW	0 204 123 578	23,81
	10.00-03.07	81/92	BSS	0 204 788 361	23,81
2.0 i	10.00-02.02	66/85/96/107	BSS	0 204 779 135	23,81
			BSS	0 204 788 361	23,81
			BSS	0 204 779 135	23,81
			BSS	0 204 779 135	23,81
2.0 i	10.00-02.02	66/85/96/107	TW	0 204 123 578	23,81
2.0 TDCi	10.00-03.07	66/85/96/	BSS	0 204 788 361	23,81
2.0 TDDi		107	BSS	0 204 779 135	23,81
2.2 TDCi	08.04-03.07	110-114	BSS	0 204 788 361	23,81
			BSS	0 204 779 135	23,81
2.5 i	10.00-02.02	125	TW	0 204 123 578	23,81
	10.00-03.07	125	BSS	0 204 788 361	23,81
			BSS	0 204 779 135	23,81
3.0 i	08.04-03.07	150	BSS	0 204 788 361	23,81
			BSS	0 204 779 135	23,81
3.0 i ST220	02.02-02.02	166	TW	0 204 123 578	23,81

		S							
3.0i ST220		02.02-03.07	166			BSS	0 204 788 361	23,81	
						BSS	0 204 779 135	23,81	
1.8i		03.02-03.07	81			BSS,LLE	0 204 125 846		
			92			BSS,LLE	0 204 125 845		
						BSS,LLE	0 204 125 846		
						BSS,LLE	0 204 125 845		
		06.03-03.07	96			BSS,LLE	0 204 125 846		
						BSS,LLE	0 204 125 845		
	MFD	03.02-03.07	81			LLE	0 204 125 845		
			92			LLE	0 204 125 845		
		06.03-03.07	96			LLE	0 204 125 845		
	OFD	03.02-03.07	81			LLE	0 204 125 846		
			92			LLE	0 204 125 846		
		06.03-03.07	96			LLE	0 204 125 846		
2.0i		03.02-03.07	107			BSS,LLE	0 204 125 846		
						BSS,LLE	0 204 125 845		
	MFD	03.02-03.07	107			LLE	0 204 125 845		
	OFD	03.02-03.07	107			LLE	0 204 125 846		
2.0TDCi		03.02-03.07	96			BSS,LLE	0 204 125 846		
						BSS,LLE	0 204 125 845		
		09.02-03.07	85			BSS,LLE	0 204 125 846		
						BSS,LLE	0 204 125 845		
		04.06-03.07	66			BSS,LLE	0 204 125 846		
						BSS,LLE	0 204 125 845		
	MFD	03.02-03.07	96			LLE	0 204 125 845		
		09.02-03.07	85			LLE	0 204 125 845		
		04.06-03.07	66			LLE	0 204 125 845		
	OFD	03.02-03.07	96			LLE	0 204 125 846		
		09.02-03.07	85			LLE	0 204 125 846		
		04.06-03.07	66			LLE	0 204 125 846		
2.0TDDi		03.02-08.02	85			BSS,LLE	0 204 125 846		
						BSS,LLE	0 204 125 845		
		03.02-03.07	66			BSS,LLE	0 204 125 846		
						BSS,LLE	0 204 125 845		
	MFD	03.02-08.02	85			LLE	0 204 125 845		
		03.02-03.07	66			LLE	0 204 125 845		
	OFD	03.02-08.02	85			LLE	0 204 125 846		
		03.02-03.07	66			LLE	0 204 125 846		
2.2TDCi		08.04-03.07	110-114			BSS,LLE	0 204 125 846		
						BSS,LLE	0 204 125 845		
	MFD	08.04-03.07	110-114			LLE	0 204 125 845		
	OFD	08.04-03.07	110-114			LLE	0 204 125 846		
2.5i		03.02-03.07	125			BSS,LLE	0 204 125 846		
						BSS,LLE	0 204 125 845		
	MFD	03.02-03.07	125			LLE	0 204 125 845		
	OFD	03.02-03.07	125			LLE	0 204 125 846		
3.0i		08.04-03.07	150			BSS,LLE	0 204 125 846		
						BSS,LLE	0 204 125 845		
	MFD	08.04-03.07	150			LLE	0 204 125 845		
	OFD	08.04-03.07	150			LLE	0 204 125 846		
3.0i ST220		03.02-03.07	166			BSS,LLE	0 204 125 846		
						BSS,LLE	0 204 125 845		
	MFD	03.02-03.07	166			LLE	0 204 125 845		
	OFD	03.02-03.07	166			LLE	0 204 125 846		
1.8i		10.00-03.07	81/92				F 026 A06 033		
2.0i		10.00-03.07	107				F 026 A06 033		
2.0TDCi		10.01-03.07	96		Get.-Nr. MMT6		0 986 486 610	31	
					Get.-Nr. MTX75		F 026 A06 033		
		09.02-03.07	85		Get.-Nr. MMT6		0 986 486 610	31	
					Get.-Nr. MTX75		F 026 A06 033		
2.0TDCi, TDDi		10.00-03.07	66				F 026 A06 033		





◀ FORD Mondeo III [01]										
2.0 TDDi	10.00-08.02	85					F 026	A06 033		
2.2 TDCi	08.04-03.07	110-114					0 986	486 610	31	
2.5 i	06.03-03.07	125	Get.-Nr. MMT6		MG6		0 986	486 610	31	
3.0 i	08.04-03.07	150					0 986	486 610	31	
3.0 i ST220	02.02-03.07	166	Get.-Nr. MTX75				F 026	A06 033		
	06.03-03.07	166	Get.-Nr. MMT6				0 986	486 610	31	
1.8 i	10.00-02.03	81					0 265	225 267^T		
		92					0 265	225 267^T		
	10.00-08.04	81						0 265	222 031^B	
		92						0 265	222 031^B	
	03.03-09.03	81						0 265	225 267^T	
		92						0 265	225 267^T	
	06.03-09.03	96					0 265	225 267^T		
	06.03-08.04	96					0 265	222 031^B		
	10.03-08.04	81						0 265	225 170^T	
		92						0 265	225 170^T	
		96						0 265	225 170^T	
	09.04-03.07	81						0 265	225 340^T	
								0 265	231 463^B	
		92						0 265	225 340^T	
								0 265	231 463^B	
	2.0 i	10.00-09.03	107					0 265	225 267^T	
								0 265	222 031^B	
10.00-08.04		107					0 265	225 170^T		
10.03-08.04		107					0 265	225 170^T		
09.04-03.07	107						0 265	225 340^T		
							0 265	231 463^B		
2.0 TDCi	10.01-02.03	96					0 265	225 267^T		
								0 265	222 031^B	
	10.01-08.04	96					0 265	222 031^B		
	09.02-09.03	85					0 265	225 267^T		
	03.03-09.03	96					0 265	225 267^T		
	10.03-08.04	85						0 265	225 170^T	
		96						0 265	225 170^T	
	09.04-03.07	85						0 265	225 340^T	
							0 265	231 463^B		
96							0 265	225 340^T		
							0 265	231 463^B		
2.0 TDCi	10.00-08.04	85					0 265	222 031^B		
2.0 TDDi	09.04-03.07	66					0 265	225 340^T		
								0 265	231 463^B	
2.0 TDDi	10.00-08.02	85					0 265	225 267^T		
								0 265	225 267^T	
	10.00-09.03	66					0 265	225 267^T		
	10.00-08.04	66					0 265	222 031^B		
10.03-08.04	66					0 265	225 170^T			
2.2 TDCi	08.04-08.04	110-114					0 265	222 031^B		
								0 265	225 170^T	
	09.04-03.07	110-114					0 265	225 340^T		
							0 265	231 463^B		
2.5 i	10.00-09.03	125					0 265	225 267^T		
								0 265	222 031^B	
	10.00-08.04	125					0 265	222 031^B		
	10.03-08.04	125					0 265	225 170^T		
09.04-03.07	125						0 265	225 340^T		
							0 265	231 463^B		
3.0 i	08.04-08.04	150					0 265	222 031^B		
								0 265	225 170^T	
	09.04-03.07	150					0 265	225 340^T		
							0 265	231 463^B		
3.0 i ST220	02.02-09.03	166					0 265	225 267^T		
								0 265	222 031^B	
	02.02-08.04	166					0 265	222 031^B		
10.03-08.04	166					0 265	225 170^T			

		S							
	3.0i ST220	09.04-03.07	166				0 265 225 340 ^T		
							0 265 231 463 ^B		
	1.8i	10.00-08.04	81/92/96				0 265 005 236		
		09.04-03.07	81/92/96				0 265 005 639		
	2.0i, TDCi	09.04-03.07	85/96/107				0 265 005 639		
	2.0i, TDCi, TDDi	10.00-08.04	85/96/107				0 265 005 236		
	2.0 TDCi, TDDi	09.04-03.07	66				0 265 005 639		
	2.0 TDDi	10.00-08.04	66				0 265 005 236		
	2.2 TDCi	08.04-08.04	110-114				0 265 005 236		
		09.04-03.07	110-114				0 265 005 639		
	2.5i	10.00-08.04	125				0 265 005 236		
		09.04-03.07	125				0 265 005 639		
	3.0i	02.02-08.04	150/166				0 265 005 236		
	3.0i ST220	09.04-03.07	150/166				0 265 005 639		
	1.8i	10.00-03.07	81/92/96				0 265 005 414		
	2.0i, TDCi, TDDi	10.00-03.07	66/85/96/107				0 265 005 414		
	2.2 TDCi	08.04-03.07	110-114				0 265 005 414		
	2.5i	10.00-03.07	125				0 265 005 414		
	3.0i, i ST220	02.02-03.07	150/166				0 265 005 414		
	1.8i	10.00-03.07	81/92/96				0 265 005 303		
	2.0i, TDCi, TDDi	10.00-03.07	66/85/96/107				0 265 005 303		
	2.2 TDCi	08.04-03.07	110-114				0 265 005 303		
	2.5i	10.00-03.07	125				0 265 005 303		
	3.0i, i ST220	02.02-03.07	150/166				0 265 005 303		
Mondeo IV Turnier [07]									
	1.6 Ti-VCT	02.07-08.10	81/92				0 986 486 611	28	
Mondeo IV [07]									
	1.6 Ti-VCT	02.07-08.10	81/92				0 986 486 611	28	
Probe									
	2.0i 16V	09.92-08.97	85-88				F 026 A01 842		
	2.5i 24V	09.92-08.97	120				F 026 A01 842		
	2.5i 24V	07.94-02.97	120				F 026 A02 537		
Puma [ECT]									
	1.4i	ABO 01.98-02.00	66			JBH	0 986 480 697	23,8	
		ABS 01.98-02.00	66			JBH	0 986 480 698	23,8	
	1.7i	ABO 06.97-02.00	92			JBH	0 986 480 697	23,8	
		ABS 06.97-02.00	92			JBH	0 986 480 698	23,8	
	1.4i	ABO 01.98-11.00	66			LLE	0 986 485 129		
		ABS 01.98-02.00	66			LLE	0 986 485 130		
	1.6i	ABO 08.00-12.01	75			LLE	0 986 485 129		
	1.7i	ABO 06.97-12.01	92			LLE	0 986 485 129		
		ABS 06.97-02.00	92			LLE	0 986 485 130		



		S									
◀ FORD Puma [ECT]											
	1.4 i	09.98-11.00	66				0 986 486 067	19,05			
	1.6 i	08.00-12.01	75				0 986 486 067	19,05			
	1.7 i	09.98-12.01	92				0 986 486 067	19,05			
Ranger											
	2.3 i	06.94-10.97	100				0 204 032 824				
	2.3 i 16V XLS	03.01-06.09	100			GES	0 204 022 753				
	3.0 D	01.05-06.09	120				0 204 022 753				
	4.0 i	01.95-10.97	119			GES	0 204 032 824				
						GES	F 026 A01 754				
		11.97-12.02	119			GES	0 204 022 753				
	2.3 i 16V XLS	03.01-06.09	100				0 204 032 831				
	2.5 i	11.97-02.01	89				0 204 032 831				
	3.0 D	01.05-06.09	120				0 204 032 831				
	4.0 i	11.97-12.02	119				0 204 032 831				
	2.3 i 16V XLS	02.05-06.09	100				0 204 0A2 573				
	3.0 D	02.05-06.09	120				0 204 0A2 573				
Ranger [12]											
	2.2 TDCi	09.11→	92/110	Get.-Nr. MT75	MG5		F 026 A06 568				
	2.2 TDCi 4x4			Get.-Nr. MT82	MG6		0 986 486 612	28			
	3.2 TDCi	09.11→	147	Get.-Nr. MT75	MG5		F 026 A06 568				
	3.2 TDCi 4x4			Get.-Nr. MT82	MG6		0 986 486 612	28			
Scorpio II Turnier [95]											
	2.0 i, i 16V	10.94-12.98	85/100			JBH,LLE	0 986 480 940	25,4			
	2.5 TD	10.94-12.98	85			JBH,LLE	0 986 480 940	25,4			
	2.9 i, i 24V	10.94-07.98	110/152			JBH,LLE	0 986 480 940	25,4			
Scorpio II [95]											
	2.0 i, i 16V	10.94-12.98	85/100			JBH,LLE	0 986 480 940	25,4			
	2.5 TD	10.94-12.98	85			JBH,LLE	0 986 480 940	25,4			
	2.9 i, i 24V	10.94-07.98	110/152			JBH,LLE	0 986 480 940	25,4			
Serie F											
	250 4x4	04.06-02.12	149			JBH,STB	0 204 032 819				
						STB,WBH	0 204 032 594				
				ABO	04.06-02.12	149		4SB,WBH	0 204 032 607		
				ABS	04.06-02.12	149		4SB,JBH	0 204 032 820		
								4SB,WBH	0 204 032 611		
	350	01.01-12.11	175			BRB,BSY	0 204 032 185				
						BRB,BSY	0 204 032 185				
		09.05-12.11	88			WBH	0 204 032 594				
1000 3.6	04.92-11.95	108							0 204 032 326 ⁶		
	350	09.05-12.11	88			EZK	0 204 0A2 586				



		S							
Streetka									
	1.6 i	12.02-12.05	70				0 986 486 067		19,05
Taurus									
	1.6	10.88-12.99	52				F 02B 348 402 ^S		
Tourneo Connect [02]									
	1.8 i, LPG, TDCi, TDDi	05.02-12.13	55/66-67/ 81-85				0 986 486 066		19,05
Tourneo Courier									
	1.0 EcoBoost	04.14→	74		LLE		0 204 123 789		20,64
					RLE,TW		0 204 123 807		20,64
	1.5 TDCi	04.14→	56		LLE		0 204 123 789		20,64
					RLE,TW		0 204 123 807		20,64
	1.6 TDCi	04.14→	70		LLE		0 204 123 789		20,64
					RLE,TW		0 204 123 807		20,64
	1.0 EcoBoost	04.14→	74		LLE		0 204 125 935		
					RLE		0 204 125 937		
	1.5 TDCi	04.14→	56		LLE		0 204 125 935		
					RLE		0 204 125 937		
	1.6 TDCi	04.14→	70		LLE		0 204 125 935		
					RLE		0 204 125 937		
Transit									
	2.8 D	03.01-07.09	68		JBH		F 026 003 354		23,8
Transit Connect [02]									
	1.8 i, LPG, TDCi, TDDi	05.02-12.13	55/66-67/ 81-85				0 986 486 066		19,05
Transit Courier									
	1.0 EcoBoost	04.14→	74		LLE		0 204 123 789		20,64
					RLE,TW		0 204 123 807		20,64
	1.5 TDCi	04.14→	56/70		LLE		0 204 123 789		20,64
					RLE,TW		0 204 123 807		20,64
	1.0 EcoBoost	04.14→	74		LLE		0 204 125 935		
					RLE		0 204 125 937		
	1.5 TDCi	04.14→	56/70		LLE		0 204 125 935		
					RLE		0 204 125 937		



◀ FORD									
Transit Custom [13]									
	FT 250 2.2 TDCi		09.12→	74				0 265 243 337 ^T	
	FT 270 2.2 TDCi		09.12→	74/92/114				0 265 243 337 ^T	
	FT 290 2.2 CDTi, 2.2 TDCi		09.12→	74/92/114				0 265 243 337 ^T	
	FT 300 2.2 DTCi		09.12→	74/92/114				0 265 243 337 ^T	
	FT 310 2.2 TDCi		09.12→	74/92/114				0 265 243 337 ^T	
	FT 330 2.2 TDCi		09.12→	92/114				0 265 243 337 ^T	
Transit Euroline [00]									
	2.0 TDCi	ABO	08.00-07.06	74/92		JBH		F 026 003 070	25,4
	2.0 TDE	ABS	08.00-07.06	74/92		JBH		F 026 003 071	25,4
	2.0 TDCi		08.00-07.03	74/92		RLE		0 204 024 181	
	2.0 TDE		08.00-07.06	74/92		LLE		0 204 024 069	
	2.0 TDE		08.00-03.02	74		LLE		0 986 486 148	15,87
	2.0 TDCi		08.00-07.06	74/92		FBK,KZB,KZE		0 204 131 703 ^A	
	2.0 TDE		12.02-02.04	74/92		FBK,KZB,KZW		0 204 131 702 ^A	
			12.02-07.06	74/92		FBK,KW2		0 204 131 711 ^A	
						KZS,KZW		0 204 131 705 ^A	
			02.04-07.06	74/92		FBK,KZW,RSA		0 204 131 710 ^A	
	2.0 TDCi		08.00-07.06	74/92				0 265 216 673 ^B	
	2.0 TDE							0 265 220 539 ^F	
Transit Euroline [06]									
	2.2 TDCi	ABO	04.06-09.11	81/85/96-96/103				0 204 123 717	25,4
		ABS	04.06-09.11	81/85/96-96/103				0 204 123 716	25,4
	2.2 TDCi		04.06-09.11	81/85/96-96/103				0 204 125 857	0 204 127 528
	2.2 TDCi		04.06-09.11	81/85/96-96/103		FBK,KZB,KZE		0 204 131 703 ^A	
						FBK,KZW,RSA		0 204 131 710 ^A	
	2.2 TDCi		04.06-08.07	96-96				0 265 231 704 ^B	
								0 265 233 341 ^F	
								0 265 234 354 ^T	
			04.06-10.07	81		TW		0 265 234 354 ^T	
			04.06-06.10	81				0 265 231 704 ^B	
								0 265 233 341 ^F	
			08.07-06.10	81		TW		0 265 235 441 ^T	
			10.07-10.07	103		TW		0 265 234 354 ^T	
			10.07-09.11	103				0 265 231 704 ^B	
								0 265 233 341 ^F	
						TW		0 265 235 441 ^T	
			10.08-09.11	85				0 265 231 704 ^B	
								0 265 233 341 ^F	
								0 265 235 441 ^T	
	2.2 TDCi		04.06-08.07	96-96				0 265 005 690	
			04.06-10.07	81		TW		0 265 005 690	
			10.07-10.07	103		TW		0 265 005 690	



		S							
Transit Euroline [12]									
	2.2 TDCi		09.11-12.13	92/103			0 204 123 716	25,4	
	2.2 TDCi		09.11-12.13	92/103			0 204 125 857		0 204 127 528
Transit Euroline [95]									
	2.0 i	ABO	08.94-03.97	84		JBH	F 026 003 136	23,8	
			04.97-07.00	84		JBH	F 026 003 354	23,8	
		ABS	04.97-07.00	84			0 204 123 355	23,81	
	2.5 D, DI, TD	ABO	08.94-03.97	51/56/63		JBH	F 026 003 136	23,8	
			04.97-08.00	51/56/63		JBH	F 026 003 354	23,8	
	2.5 D, DI, TD, TDI	ABS	04.97-08.00	51/56/63/85			0 204 123 355	23,81	
	2.5 TDI	ABO	03.99-08.00	85		JBH	F 026 003 354	23,8	
	2.0 i		04.97-07.00	84		LLE	0 204 125 531		
		ABO	08.94-03.97	84		LLE	0 204 125 101		
							0 204 125 127		
	2.5 D, DI, TD	ABO	08.94-03.97	51/56/63		LLE	0 204 125 101		
							0 204 125 127		
	2.5 D, DI, TD, TDI		04.97-08.00	51/56/63/85		LLE	0 204 125 531		
	2.0 i		08.94-07.00	84		BRD,TW	0 204 131 359 ^A		
						BRV,TW	0 204 131 354 ^A		
							0 204 131 356 ^A		
							0 204 131 368 ^A		
	2.5 D		08.94-08.00	51/56/63/		BRD,TW	0 204 131 360 ^A		
	2.5 DI			85			0 204 131 367 ^A		
	2.5 TD					BRV,TW	0 204 031 298 ^A		
	2.5 TDI						0 204 031 299 ^A		
	2.0 i		11.97-07.00	84			0 265 220 468 ^J		
	2.5 D, DI, TD, TDI		11.97-08.00	51/56/63/85			0 265 220 468 ^J		
	2.5 DI	ABS, OAS	11.97-08.00	56		AK	0 265 216 625 ^H		
	2.0 i		11.97-07.00	84			1 273 004 260 ^J		
	2.5 D, DI, TD, TDI		11.97-08.00	51/56/63/85			1 273 004 260 ^J		
	2.5 DI	ABS, OAS	11.97-08.00	56		AK	1 273 004 340 ^H		
Transit Nugget [00]									
	2.0 TDCi	ABO	08.00-07.06	74/92		JBH	F 026 003 070	25,4	
	2.0 TDE	ABS	08.00-07.06	74/92		JBH	F 026 003 071	25,4	
	2.0 TDCi		08.00-07.03	74/92		RLE	0 204 024 181		
	2.0 TDE		08.00-07.06	74/92		LLE	0 204 024 069		
	2.0 TDE		08.00-03.02	74		LLE	0 986 486 148	15,87	
	2.0 TDCi		08.00-07.06	74/92		FBK,KZB,KZE	0 204 131 703 ^A		
	2.0 TDE		12.02-02.04	74/92		FBK,KZB,KZW	0 204 131 702 ^A		



◀ FORD Transit Nugget [00]								
	2.0 TDCi	12.02-07.06	74/92		FBK,KW2	0 204 131 711 ^A		
	2.0 TDE				FBK,KZW,ORA	0 204 131 704 ^A		
		02.04-07.06	74/92		KZS,KZW	0 204 131 705 ^A		
					FBK,KZW,RSA	0 204 131 710 ^A		
	2.0 TDCi	08.00-07.06	74/92			0 265 216 673 ^B		
	2.0 TDE					0 265 220 539 ^F		
Transit Nugget [06]								
	2.2 TDCi	ABO	04.06-09.11	81/85/96-96/103		0 204 123 717	25,4	
		ABS	04.06-09.11	81/85/96-96/103		0 204 123 716	25,4	
	2.2 TDCi		04.06-09.11	81/85/96-96/103		0 204 125 857		0 204 127 528
	2.2 TDCi		04.06-09.11	81/85/96-96/103	FBK,KZB, KZE	0 204 131 703 ^A		
	2.2 TDCi		04.06-08.07	96-96		0 265 231 704 ^B		
						0 265 233 341 ^F		
						0 265 234 354 ^T		
			04.06-10.07	81	TW	0 265 234 354 ^T		
			04.06-06.10	81		0 265 231 704 ^B		
						0 265 233 341 ^F		
			08.07-06.10	81	TW	0 265 235 441 ^T		
			10.07-10.07	103	TW	0 265 234 354 ^T		
			10.07-09.11	103		0 265 231 704 ^B		
						0 265 233 341 ^F		
					TW	0 265 235 441 ^T		
			10.08-09.11	85		0 265 231 704 ^B		
						0 265 233 341 ^F		
						0 265 235 441 ^T		
	2.2 TDCi		04.06-08.07	96-96		0 265 005 690		
			04.06-10.07	81	TW	0 265 005 690		
			10.07-10.07	103	TW	0 265 005 690		
Transit Nugget [12]								
	2.2 TDCi		09.11-12.13	92/103		0 204 123 716	25,4	
	2.2 TDCi		09.11-12.13	92/103		0 204 125 857		0 204 127 528
Transit Nugget [95]								
	2.0 i	ABO	08.94-03.97	84	JBH	F 026 003 136	23,8	
			04.97-07.00	84	JBH	F 026 003 354	23,8	
		ABS	04.97-07.00	84		0 204 123 355	23,81	
	2.5 D, DI, TD	ABO	08.94-03.97	51/56/63	JBH	F 026 003 136	23,8	
			04.97-08.00	51/56/63	JBH	F 026 003 354	23,8	
	2.5 D, DI, TD, TDI	ABS	04.97-08.00	51/56/63/85		0 204 123 355	23,81	
	2.5 TDI	ABO	03.99-08.00	85	JBH	F 026 003 354	23,8	
	2.0 i		04.97-07.00	84	LLE	0 204 125 531		
		ABO	08.94-03.97	84	LLE	0 204 125 101		
						0 204 125 127		



		S							
	2.5 D, DI, TD	ABO	08.94-03.97	51/56/63		LLE	0 204 125 101		
							0 204 125 127		
	2.5 D, DI, TD, TDI		04.97-08.00	51/56/63/85		LLE	0 204 125 531		
	2.0 i		08.94-07.00	84		BRD,TW	0 204 131 359 ^A		
						BRV,TW	0 204 131 354 ^A		
							0 204 131 356 ^A		
							0 204 131 368 ^A		
	2.5 D		08.94-08.00	51/56/63/		BRD,TW	0 204 131 360 ^A		
	2.5 DI			85			0 204 131 367 ^A		
	2.5 TD					BRV,TW	0 204 031 298 ^A		
	2.5 TDI						0 204 031 299 ^A		
	2.0 i		11.97-07.00	84			0 265 220 468 ^J		
	2.5 D, DI, TD, TDI		11.97-08.00	51/56/63/85			0 265 220 468 ^J		
	2.5 DI	ABS, OAS	11.97-08.00	56		AK	0 265 216 625 ^H		
	2.0 i		11.97-07.00	84			1 273 004 260 ^J		
	2.5 D, DI, TD, TDI		11.97-08.00	51/56/63/85			1 273 004 260 ^J		
	2.5 DI	ABS, OAS	11.97-08.00	56		AK	1 273 004 340 ^H		
Transit Tourneo Custom [13]									
	2.2 TDCi		09.12→	74/92/114			0 265 243 337 ^T		
Transit Tourneo [00]									
	2.0 TDCi	ABO	08.00-07.06	74/92		JBH	F 026 003 070	25,4	
	2.0 TDE	ABS	08.00-07.06	74/92		JBH	F 026 003 071	25,4	
	2.0 TDCi		08.00-07.03	74/92		RLE	0 204 024 181		
	2.0 TDE		08.00-07.06	74/92		LLE	0 204 024 069		
	2.0 TDE		08.00-03.02	74		LLE	0 986 486 148	15,87	
	2.0 TDCi		08.00-07.06	74/92		FBK,KZB,KZE	0 204 131 703 ^A		
	2.0 TDE		12.02-02.04	74/92		FBK,KZB,KZW	0 204 131 702 ^A		
			12.02-07.06	74/92		FBK,KW2	0 204 131 711 ^A		
						KZS,KZW	0 204 131 705 ^A		
			02.04-07.06	74/92		FBK,KZW,RSA	0 204 131 710 ^A		
	2.0 TDCi		08.00-07.06	74/92			0 265 216 673 ^B		
	2.0 TDE						0 265 220 539 ^F		
Transit Tourneo [06]									
	2.2 TDCi	ABO	04.06-09.11	81/85/96-96/103			0 204 123 717	25,4	
		ABS	04.06-09.11	81/85/96-96/103			0 204 123 716	25,4	
	2.2 TDCi		04.06-09.11	81/85/96-96/103			0 204 125 857		0 204 127 528
	2.2 TDCi		04.06-09.11	81/85/96-96/103		FBK,KZB,KZE	0 204 131 703 ^A		
						FBK,KZB,KZW	0 204 131 702 ^A		



◀ FORD Transit Tourneo [06]														
	2.2 TDCi		04.06-08.07	96-96			0 265 231 704 ^B							
							0 265 233 341 ^F							
							0 265 234 354 ^T							
			04.06-10.07	81		TW	0 265 234 354 ^T							
			04.06-06.10	81			0 265 231 704 ^B							
							0 265 233 341 ^F							
			08.07-06.10	81		TW	0 265 235 441 ^T							
			10.07-10.07	103		TW	0 265 234 354 ^T							
			10.07-09.11	103			0 265 231 704 ^B							
							0 265 233 341 ^F							
				0 265 235 441 ^T										
			10.08-09.11	85		TW	0 265 231 704 ^B							
							0 265 233 341 ^F							
							0 265 235 441 ^T							
	2.2 TDCi		04.06-08.07	96-96			0 265 005 690							
			04.06-10.07	81		TW	0 265 005 690							
			10.07-10.07	103		TW	0 265 005 690							
Transit Tourneo [12]														
	2.2 TDCi		09.11-12.13	74/92/103			0 204 123 716	25,4						
	2.2 TDCi		09.11-12.13	74/92/103			0 204 125 857		0 204 127 528					
Transit Tourneo [95]														
	2.0 i		08.94-03.97	84		JBH	F 026 003 136	23,8						
			04.97-07.00	84		JBH	F 026 003 354	23,8						
			ABS	04.97-07.00	84			0 204 123 355	23,81					
			2.5 D, DI, TD, TDI	08.94-03.97	51/56/63		JBH	F 026 003 136	23,8					
				04.97-08.00	51/56/63		JBH	F 026 003 354	23,8					
				ABS	04.97-08.00	51/56/63/85			0 204 123 355	23,81				
			2.5 TDI	ABO	03.99-08.00	85		JBH	F 026 003 354	23,8				
				2.0 i		04.97-07.00	84		LLE	0 204 125 531				
						ABO	08.94-03.97	84		LLE	0 204 125 101			
											0 204 125 127			
2.5 D, DI, TD, TDI	04.97-08.00	51/56/63/85					LLE	0 204 125 531						
	ABO	08.94-03.97				51/56/63		LLE	0 204 125 101					
						0 204 125 127								
	2.0 i		08.94-07.00	84		BRD,TW BRV,TW	0 204 131 359 ^A							
							0 204 131 354 ^A							
							0 204 131 356 ^A							
							0 204 131 368 ^A							
	2.5 D 2.5 DI 2.5 TD 2.5 TDI			08.94-08.00	51/56/63/85		BRD,TW BRV,TW	0 204 131 360 ^A						
								0 204 131 367 ^A						
								0 204 031 298 ^A						
								0 204 031 299 ^A						
	2.0 i		11.97-07.00	84			0 265 220 468 ^J							
			2.5 D, DI, TD, TDI	11.97-08.00	51/56/63/85			0 265 220 468 ^J						
			2.5 DI	ABS, OAS	11.97-08.00	56		AK	0 265 216 625 ^H					
	2.0 i		11.97-07.00	84			1 273 004 260 ^J							
			2.5 D, DI, TD, TDI	11.97-08.00	51/56/63/85			1 273 004 260 ^J						

F



2.5 DI ABS, 11.97-08.00 56 AK 1 273 004 340^H
OAS

Transit [00]



	FT 240 K/S 2.0 TD	ABO	08.00-07.06	55/63	JBH	F 026 003 070	25,4
	FT 240 K/S 2.0 TDE	ABS	08.00-07.06	55/63	JBH	F 026 003 071	25,4
	FT 260 K/S 2.0 TD, 2.0 TDCi,	ABO	08.00-07.06	55/63/66/74/92/103-107	JBH	F 026 003 070	25,4
	2.0 TDE, 2.3i, 2.4 TDE	ABS	08.00-07.06	55/63/66/74/92/103-107	JBH	F 026 003 071	25,4
	FT 280 K/S 2.0 TD, 2.0 TDCi,	ABO	08.00-07.06	55/63/66/74/92/103-107	JBH	F 026 003 070	25,4
	2.0 TDE, 2.3i, 2.4 TDE	ABS	08.00-07.06	55/63/66/74/92/103-107	JBH	F 026 003 071	25,4
	FT 280 L 2.3i, 2.4 TDE	ABO	01.00-07.06	55/66/85/92/103-107	JBH	F 026 003 070	25,4
		ABS	01.00-07.06	55/66/85/92/103-107	JBH	F 026 003 071	25,4
	FT 280 M 2.0 TD, 2.0 TDCi,	ABO	08.00-07.06	55/63/66/74/92/103-107	JBH	F 026 003 070	25,4
	2.0 TDE, 2.3i, 2.4 TDE	ABS	08.00-07.06	55/63/66/74/92/103-107	JBH	F 026 003 071	25,4
	FT 280 S 2.4 TDI	ABO	01.01-05.06	66	JBH	F 026 003 070	25,4
		ABS	01.01-05.06	66	JBH	F 026 003 071	25,4
	FT 300 K/S 2.0 TD, 2.0 TDCi,	ABO	08.00-07.06	55/63/74/92/107	JBH	F 026 003 070	25,4
	2.0 TDE, 2.3i	ABS	08.00-07.06	55/63/74/92/107	JBH	F 026 003 071	25,4
	FT 300 L 2.0 TD, 2.0 TDCi, 2.0 TDE,	ABO	08.00-07.06	55/63/74/92/107	JBH	F 026 003 070	25,4
	2.3i	ABS	08.00-07.06	55/63/74/92/107	JBH	F 026 003 071	25,4
	FT 300 M 2.0 TD, 2.0 TDCi, 2.0 TDE,	ABO	08.00-07.06	55/63/74/92/107	JBH	F 026 003 070	25,4
	2.3i	ABS	08.00-07.06	55/63/74/92/107	JBH	F 026 003 071	25,4
	FT 300 S 2.0 TDCi	ABO	01.01-05.06	66/74/92	JBH	F 026 003 070	25,4
	FT 300 S 2.4 TDI	ABS	01.01-05.06	66/74/92	JBH	F 026 003 071	25,4
	FT 310 S 2.4 TDI	ABO	01.01-05.06	88	JBH	F 026 003 070	25,4
		ABS	01.01-05.06	88	JBH	F 026 003 071	25,4
	FT 330 K/S 2.0 TDCi, 2.0 TDE, 2.3i,	ABO	01.00-07.06	55/66/74/85/88/92/101/103-107	JBH	F 026 003 070	25,4
	2.4 TD, 2.4 TDCi, 2.4 TDE	ABS	01.00-07.06	55/66/74/85/88/92/101/103-107	JBH	F 026 003 071	25,4
	FT 330 L 2.0 TDCi, 2.0 TDE, 2.3i,	ABO	01.00-07.06	55/66/74/85/88/92/101/103-107	JBH	F 026 003 070	25,4
	2.4 TD, 2.4 TDCi, 2.4 TDE, 2.4 TDI	ABS	01.00-07.06	55/66/74/85/88/92/101/103-107	JBH	F 026 003 071	25,4
	FT 330 M 2.0 TDCi, 2.0 TDE, 2.3i,	ABO	01.00-07.06	55/66/74/85/88/92/101/103-107	JBH	F 026 003 070	25,4
	2.4 TD, 2.4 TDCi, 2.4 TDE, 2.4 TDI	ABS	01.00-07.06	55/66/74/85/88/92/101/103-107	JBH	F 026 003 071	25,4
	FT 330 S 2.4 TDI	ABO	01.01-05.06	66/74/88	JBH	F 026 003 070	25,4
		ABS	01.01-05.06	66/74/88	JBH	F 026 003 071	25,4
	FT 350 EL 2.0 TDCi, 2.0 TDE, 2.3i,	ABO	01.00-07.06	55/66/74/85/92/101/103-107	JBH	F 026 003 070	25,4
	2.4 TD, 2.4 TDCi, 2.4 TDE	ABS	01.00-07.06	55/66/74/85/92/101/103-107	JBH	F 026 003 071	25,4
	FT 350 E 2.4 TDI	ABO	01.01-05.06	66/88/96	JBH	F 026 003 070	25,4
		ABS	01.01-05.06	66/88/96	JBH	F 026 003 071	25,4
	FT 350 L 2.0 TDCi, 2.0 TDE, 2.3i,	ABO	01.00-07.06	55/66/74/85/88/92/96/101/103-107	JBH	F 026 003 070	25,4
	2.4 TD, 2.4 TDCi, 2.4 TDE, 2.4 TDI	ABS	01.00-07.06	55/66/74/85/88/92/96/101/103-107	JBH	F 026 003 071	25,4
	FT 350 M 2.0 TDCi, 2.0 TDE, 2.3i,	ABO	01.00-07.06	55/66/74/85/88/92/96/101/103-107	JBH	F 026 003 070	25,4
	2.4 TD, 2.4 TDCi, 2.4 TDE, 2.4 TDI	ABS	01.00-07.06	55/66/74/85/88/92/96/101/103-107	JBH	F 026 003 071	25,4
	FT 430 EL 2.4 TD, 2.4 TDCi,	ABO	08.02-07.06	55/66/85/92/101	JBH	F 026 003 070	25,4
	2.4 TDE	ABS	08.02-07.06	55/66/85/92/101	JBH	F 026 003 071	25,4
	FT 430 E 2.4 TDI	ABO	06.04-05.06	96	JBH	F 026 003 070	25,4
		ABS	06.04-05.06	96	JBH	F 026 003 071	25,4
	FT 430 M 2.4 TD, 2.4 TDCi, 2.4 TDE	ABO	08.02-07.06	55/85/92/101	JBH	F 026 003 070	25,4
		ABS	08.02-07.06	55/85/92/101	JBH	F 026 003 071	25,4

	FT 240 K/S 2.0 TD		08.00-07.03	55/63	RLE	0 204 024 181	
	FT 240 K/S 2.0 TDE		08.00-07.06	55/63	LLE	0 204 024 069	
	FT 260 K/S 2.0 TD		08.00-07.03	55/63	RLE	0 204 024 181	
	FT 260 K/S 2.0 TDE		08.00-07.06	55/63	LLE	0 204 024 069	
	FT 260 K/S 2.0 TDCi		08.00-07.03	74/92	RLE	0 204 024 181	
	FT 260 K/S 2.0 TDE		08.00-07.06	74/92	LLE	0 204 024 069	
	FT 260 K/S 2.3i		08.01-07.06	103-107	TW	0 204 024 069	
	FT 260 K/S 2.4 TDE		04.01-07.06	66	TW	0 204 024 069	
	FT 280 K/S 2.0 TD		08.00-07.03	55/63	RLE	0 204 024 181	
	FT 280 K/S 2.0 TDE		08.00-07.06	55/63	LLE	0 204 024 069	
	FT 280 K/S 2.0 TDCi		08.00-07.03	74/92	RLE	0 204 024 181	
	FT 280 K/S 2.0 TDE		08.00-07.06	74/92	LLE	0 204 024 069	





◀ FORD Transit [00]						
FT 280 K/S 2.3i	08.01-07.06	103-107		TW	0 204 024 069	
FT 280 K/S 2.4 TDE	04.01-07.06	66		TW	0 204 024 069	
FT 280 L 2.3i, 2.4 TDE	01.00-07.06	55/66/85/92/103-107		TW	0 204 024 069	
FT 280 M 2.0 TD	08.00-07.03	55/63		RLE	0 204 024 181	
FT 280 M 2.0 TDE	08.00-07.06	55/63		LLE	0 204 024 069	
FT 280 M 2.0 TDCi	08.00-07.03	74/92		RLE	0 204 024 181	
FT 280 M 2.0 TDE	08.00-07.06	74/92		LLE	0 204 024 069	
FT 280 M 2.3i	08.01-07.06	103-107		TW	0 204 024 069	
FT 280 M 2.4 TDE	04.01-07.06	66		TW	0 204 024 069	
FT 280 S 2.4 TDI	01.01-05.06	66		TW	0 204 024 069	
FT 300 K/S 2.0 TD, 2.0 TDCi, 2.0 TDE	08.00-07.03	55/63/74/92		RLE	0 204 024 181	
	08.00-07.06	55/63/74/92		LLE	0 204 024 069	
FT 300 K/S 2.3i	08.00-07.06	107		TW	0 204 024 069	
FT 300 L 2.0 TD	08.00-07.03	55/63/74/92		BDM,RLE	0 204 024 181	
FT 300 L 2.0 TDCi	08.00-07.06	55/63/74/92		BDM,LLE	0 204 024 069	
FT 300 L 2.0 TDE	07.03-07.06	55/63/74/92		BDM	0 204 024 692	
FT 300 L 2.3i	08.00-07.06	107		TW	0 204 024 069	
FT 300 M 2.0 TD, 2.0 TDCi, 2.0 TDE	08.00-07.03	55/63/74/92		RLE	0 204 024 181	
	08.00-07.06	55/63/74/92		LLE	0 204 024 069	
FT 300 M 2.3i	08.00-07.06	107		TW	0 204 024 069	
FT 300 S 2.0 TDCi, 2.4 TDI	01.01-05.06	66/74/92		TW	0 204 024 069	
FT 310 S 2.4 TDI	01.01-05.06	88		TW	0 204 024 069	
FT 330 K/S 2.0 TDCi	05.02-07.03	92		RLE	0 204 024 181	
	05.02-07.06	92		LLE	0 204 024 069	
FT 330 K/S 2.0 TDE	08.03-07.06	74		LLE	0 204 024 069	
FT 330 K/S 2.3i, 2.4 TDCi	12.00-07.06	101/103-107		TW	0 204 024 069	
FT 330 K/S 2.4 TD, 2.4 TDE	01.00-07.06	55/66		TW	0 204 024 069	
FT 330 K/S 2.4 TDE	01.00-07.06	85/88		TW	0 204 024 069	
		92		TW	0 204 024 069	
FT 330 L 2.0 TDCi	05.02-07.03	92		RLE	0 204 024 181	
	05.02-07.06	92		LLE	0 204 024 069	
FT 330 L 2.0 TDE	08.03-07.06	74		LLE	0 204 024 069	
FT 330 L 2.3i, 2.4 TDCi	12.00-07.06	101/103-107		TW	0 204 024 069	
FT 330 L 2.4 TD, 2.4 TDE, 2.4 TDI	01.00-07.06	55/66		TW	0 204 024 069	
FT 330 L 2.4 TDE	01.00-07.06	92		TW	0 204 024 069	
FT 330 L 2.4 TDE, 2.4 TDI	01.00-07.06	85/88		TW	0 204 024 069	
FT 330 M 2.0 TDCi	05.02-07.03	92		RLE	0 204 024 181	
	05.02-07.06	92		LLE	0 204 024 069	
FT 330 M 2.0 TDE	08.03-07.06	74		LLE	0 204 024 069	
FT 330 M 2.3i, 2.4 TDCi	12.00-07.06	101/103-107		TW	0 204 024 069	
FT 330 M 2.4 TD, 2.4 TDE, 2.4 TDI	01.00-07.06	55/66		TW	0 204 024 069	
FT 330 M 2.4 TDE	01.00-07.06	92		TW	0 204 024 069	
FT 330 M 2.4 TDE, 2.4 TDI	01.00-07.06	85/88		TW	0 204 024 069	
FT 330 S 2.4 TDI	01.01-05.06	66/74/88		TW	0 204 024 069	
FT 350 EL 2.0 TDCi	05.02-07.03	92		BDM,RLE	0 204 024 181	
	05.02-07.06	92		BDM,LLE	0 204 024 069	
	07.03-07.06	92		BDM	0 204 024 692	
FT 350 EL 2.0 TDE	08.03-07.06	74		BDM	0 204 024 692	
				BDM,LLE	0 204 024 069	
FT 350 EL 2.3i, 2.4 TDCi	12.00-07.06	101/103-107		TW	0 204 024 069	
FT 350 EL 2.4 TD, 2.4 TDE	01.00-07.06	55/66		TW	0 204 024 069	
FT 350 EL 2.4 TDE	01.00-07.06	92		TW	0 204 024 069	
	03.04-07.06	85		TW	0 204 024 069	
FT 350 E 2.4 TDI	01.01-05.06	66/88/96		TW	0 204 024 069	
FT 350 L 2.0 TDCi	05.02-07.03	92		BDM,RLE	0 204 024 181	
	05.02-07.06	92		BDM,LLE	0 204 024 069	
	07.03-07.06	92		BDM	0 204 024 692	
FT 350 L 2.0 TDE	08.03-07.06	74		BDM	0 204 024 692	
				BDM,LLE	0 204 024 069	
FT 350 L 2.3i, 2.4 TDCi, 2.4 TDI	12.00-07.06	96/101/103-107		TW	0 204 024 069	
FT 350 L 2.4 TD, 2.4 TDE, 2.4 TDI	01.00-07.06	55/66		TW	0 204 024 069	
FT 350 L 2.4 TDE	01.00-07.06	92		TW	0 204 024 069	
FT 350 L 2.4 TDE, 2.4 TDI	01.00-07.06	85/88		TW	0 204 024 069	



		S							
FT 350 M 2.0 TDCi	05.02-07.03	92				RLE	0 204 024 181		
	05.02-07.06	92				LLE	0 204 024 069		
FT 350 M 2.0 TDE	08.03-07.06	74				LLE	0 204 024 069		
FT 350 M 2.3i, 2.4 TDCi, 2.4 TDI	12.00-07.06	96/101/103-107				TW	0 204 024 069		
FT 350 M 2.4 TD, 2.4 TDE, 2.4 TDI	01.00-07.06	55/66				TW	0 204 024 069		
FT 350 M 2.4 TDE	01.00-07.06	92				TW	0 204 024 069		
FT 350 M 2.4 TDE, 2.4 TDI	01.00-07.06	85/88				TW	0 204 024 069		
FT 430 EL 2.4 TD, 2.4 TDCi, 2.4 TDE	08.02-07.06	55/66/85/92/101				TW	0 204 024 069		
FT 430 E 2.4 TDI	06.04-05.06	96				TW	0 204 024 069		
FT 430 M 2.4 TD, 2.4 TDCi, 2.4 TDE	08.02-07.06	55/85/92/101				TW	0 204 024 069		
FT 240 K/S 2.0 TD, 2.0 TDE	08.00-03.02	55/63				LLE	0 986 486 148	15,87	
FT 260 K/S 2.0 TD, 2.0 TDE, 2.3i, 2.4 TDE	08.00-03.02	55/63/66/74/103-107				LLE	0 986 486 148	15,87	
FT 280 K/S 2.0 TD, 2.0 TDE, 2.3i, 2.4 TDE	08.00-03.02	55/63/66/74/103-107				LLE	0 986 486 148	15,87	
FT 280 L 2.3i, 2.4 TDE	01.00-03.02	55/66/92/103-107				LLE	0 986 486 148	15,87	
FT 280 M 2.0 TD, 2.0 TDE, 2.3i, 2.4 TDE	08.00-03.02	55/63/66/74/103-107				LLE	0 986 486 148	15,87	
FT 280 S 2.4 TDI	01.01-05.06	66					0 986 486 148	15,87	
FT 300 K/S 2.0 TD, 2.0 TDE, 2.3i	08.00-03.02	55/63/74/107				LLE	0 986 486 148	15,87	
FT 300 L 2.0 TD, 2.0 TDE, 2.3i	08.00-03.02	55/63/74/107				LLE	0 986 486 148	15,87	
FT 300 M 2.0 TD, 2.0 TDE, 2.3i	08.00-03.02	55/63/74/107				LLE	0 986 486 148	15,87	
FT 300 S 2.4 TDI	01.01-05.06	66/74					0 986 486 148	15,87	
FT 310 S 2.4 TDI	01.01-05.06	88					0 986 486 148	15,87	
FT 330 K/S 2.3i, 2.4 TD, 2.4 TDE	01.00-03.02	55/66/88/92/103-107				LLE	0 986 486 148	15,87	
FT 330 L 2.3i, 2.4 TDE	01.00-03.02	92/103-107				LLE	0 986 486 148	15,87	
FT 330 L 2.4 TD	01.00-03.02	55				LLE	0 986 486 148	15,87	
FT 330 L 2.4 TDE	01.00-03.02	66/88				LLE	0 986 486 148	15,87	
FT 330 L 2.4 TDI	01.01-05.06	66/88					0 986 486 148	15,87	
FT 330 M 2.3i, 2.4 TDE	01.00-03.02	92/103-107				LLE	0 986 486 148	15,87	
FT 330 M 2.4 TD	01.00-03.02	55				LLE	0 986 486 148	15,87	
FT 330 M 2.4 TDE	01.00-03.02	66/88				LLE	0 986 486 148	15,87	
FT 330 M 2.4 TDI	01.01-05.06	66/88					0 986 486 148	15,87	
FT 330 S 2.4 TDI	01.01-05.06	66/74/88					0 986 486 148	15,87	
FT 350 EL 2.3i, 2.4 TD, 2.4 TDE	01.00-03.02	55/66/92/103-107				LLE	0 986 486 148	15,87	
FT 350 E 2.4 TDI	01.01-05.06	66/88/96					0 986 486 148	15,87	
FT 350 L 2.3i	12.00-03.02	103-107				LLE	0 986 486 148	15,87	
FT 350 L 2.4 TD	01.00-03.02	55				LLE	0 986 486 148	15,87	
FT 350 L 2.4 TDE	01.00-03.02	66/88				LLE	0 986 486 148	15,87	
		92				LLE	0 986 486 148	15,87	
FT 350 L 2.4 TDI	01.01-05.06	66/88					0 986 486 148	15,87	
	06.04-05.06	96					0 986 486 148	15,87	
FT 350 M 2.3i	12.00-03.02	103-107				LLE	0 986 486 148	15,87	
FT 350 M 2.4 TD	01.00-03.02	55				LLE	0 986 486 148	15,87	
FT 350 M 2.4 TDE	01.00-03.02	66/88				LLE	0 986 486 148	15,87	
		92				LLE	0 986 486 148	15,87	
FT 350 M 2.4 TDI	01.01-05.06	66/88					0 986 486 148	15,87	
	06.04-05.06	96					0 986 486 148	15,87	
FT 430 E 2.4 TDI	06.04-05.06	96					0 986 486 148	15,87	
FT 260 K/S 2.3i	04.02-07.06	103-107					F 026 A06 568		
FT 260 K/S 2.4 TDE	04.02-07.06	66				GS	F 026 A06 568		
FT 280 K/S 2.3i	04.02-07.06	103-107					F 026 A06 568		
FT 280 K/S 2.4 TDE	04.02-07.06	66				GS	F 026 A06 568		
FT 280 L 2.3i	04.02-07.06	103-107					F 026 A06 568		
FT 280 L 2.4 TDE	04.02-09.03	55					F 026 A06 568		
	04.02-07.06	66				GS	F 026 A06 568		
		92				GS	F 026 A06 568		
	03.04-07.06	85					F 026 A06 568		
FT 280 M 2.3i	04.02-07.06	103-107					F 026 A06 568		
FT 280 M 2.4 TDE	04.02-07.06	66				GS	F 026 A06 568		
FT 300 K/S 2.3i	04.02-07.06	107					F 026 A06 568		
FT 300 L 2.3i	04.02-07.06	107					F 026 A06 568		
FT 300 M 2.3i	04.02-07.06	107					F 026 A06 568		
FT 330 K/S 2.3i	04.02-07.06	103-107					F 026 A06 568		













◀ FORD Transit [00]

FT 330 K/S 2.4 TD	04.02-09.03	55		F 026 A06 568	
FT 330 K/S 2.4 TDCi	03.04-07.06	101		0 986 486 612	28
FT 330 K/S 2.4 TDE	04.02-07.06	66	GS	F 026 A06 568	
		85/88		F 026 A06 568	
		92	GS	F 026 A06 568	
FT 330 L 2.3i	04.02-07.06	103-107		F 026 A06 568	
FT 330 L 2.4 TD	04.02-09.03	55		F 026 A06 568	
FT 330 L 2.4 TDCi	03.04-07.06	101		F 026 A06 568	
				0 986 486 612	28
FT 330 L 2.4 TDE	04.02-07.06	66	GS	F 026 A06 568	
		85/88		F 026 A06 568	
		92	GS	F 026 A06 568	
FT 330 M 2.3i	04.02-07.06	103-107		F 026 A06 568	
FT 330 M 2.4 TD	04.02-09.03	55		F 026 A06 568	
FT 330 M 2.4 TDCi	03.04-07.06	101		0 986 486 612	28
				F 026 A06 568	
FT 330 M 2.4 TDE	04.02-07.06	66	GS	F 026 A06 568	
		85/88		F 026 A06 568	
		92	GS	F 026 A06 568	
FT 350 EL 2.3i	04.02-07.06	103-107		F 026 A06 568	
FT 350 EL 2.4 TD	04.02-09.03	55		F 026 A06 568	
FT 350 EL 2.4 TDCi	03.04-07.06	101		0 986 486 612	28
				F 026 A06 568	
FT 350 EL 2.4 TDE	04.02-07.06	66	GS	F 026 A06 568	
		92	GS	F 026 A06 568	
		85		F 026 A06 568	
FT 350 L 2.3i	04.02-07.06	103-107		F 026 A06 568	
FT 350 L 2.4 TD	04.02-09.03	55		F 026 A06 568	
FT 350 L 2.4 TDCi	03.04-07.06	101		F 026 A06 568	
				0 986 486 612	28
FT 350 L 2.4 TDE	04.02-07.06	66	GS	F 026 A06 568	
		85/88		F 026 A06 568	
		92	GS	F 026 A06 568	
FT 350 M 2.3i	04.02-07.06	103-107		F 026 A06 568	
FT 350 M 2.4 TD	04.02-09.03	55		F 026 A06 568	
FT 350 M 2.4 TDCi	03.04-07.06	101		0 986 486 612	28
				F 026 A06 568	
FT 350 M 2.4 TDE	04.02-07.06	66	GS	F 026 A06 568	
		85/88		F 026 A06 568	
		92	GS	F 026 A06 568	
FT 430 EL 2.4 TD	08.02-09.03	55		F 026 A06 568	
FT 430 EL 2.4 TDCi	03.04-07.06	101		0 986 486 612	28
				F 026 A06 568	
FT 430 EL 2.4 TDE	08.02-07.06	66	GS	F 026 A06 568	
		92	GS	F 026 A06 568	
		85		F 026 A06 568	
FT 430 M 2.4 TD	08.02-09.03	55		F 026 A06 568	
FT 430 M 2.4 TDCi	03.04-07.06	101		0 986 486 612	28
				F 026 A06 568	
FT 430 M 2.4 TDE	08.02-07.06	92	GS	F 026 A06 568	
		03.04-07.06	85		F 026 A06 568









	FT 240 K/S 2.0 TD	08.00-07.06	55/63	FBK,KZB,RSA	0 204 131 707 ^A	
	FT 240 K/S 2.0 TDE	12.02-07.06	55/63	FBK,KZB,KZE	0 204 131 703 ^A	
			KZS,KZW	0 204 131 705 ^A		
02.04-07.06			55/63	FBK,KZW,RSA	0 204 131 710 ^A	
FT 260 K/S 2.0 TD	08.00-07.06	55/63	FBK,KZB,RSA	0 204 131 707 ^A		
FT 260 K/S 2.0 TDE	12.02-02.04	55/63	KZS,KZW	0 204 131 705 ^A		
		12.02-07.06	55/63	FBK,KZB,KZE	0 204 131 703 ^A	
		02.04-07.06	55/63	FBK,KZW,RSA	0 204 131 710 ^A	
				FBK,KZB,RSA	0 204 131 707 ^A	
FT 260 K/S 2.0 TDCi	12.02-02.04	74/92	KZS,KZW	0 204 131 705 ^A		
		12.02-07.06	74/92	FBK,KZB,KZE	0 204 131 703 ^A	
		02.04-07.06	74/92	FBK,KZW,RSA	0 204 131 710 ^A	
				FBK,KZB,RSA	0 204 131 707 ^A	
FT 260 K/S 2.3i	12.02-02.04	103-107	FBK,KZB,KZE	0 204 131 703 ^A		
		12.02-07.06	103-107	FBK,KZG,KZW	0 204 131 706 ^A	
FT 260 K/S 2.4 TDE	12.02-02.04	66	FBK,KZB,KZE	0 204 131 703 ^A		
		12.02-07.06	66	FBK,KZG,KZW	0 204 131 706 ^A	

		S							
FT 280 K/S 2.0 TD		08.00-07.06	55/63			FBK,KZB,KZE	0 204 131 703 ^A		
FT 280 K/S 2.0 TDE						FBK,KZB,RSA	0 204 131 707 ^A		
		12.02-02.04	55/63			KZS,KZW	0 204 131 705 ^A		
		12.02-07.06	55/63			FBK,KZB,KZW	0 204 131 702 ^A		
		02.04-07.06	55/63			FBK,KZW,RSA	0 204 131 710 ^A		
FT 280 K/S 2.0 TDCi		08.00-07.06	74/92			FBK,KZB,KZE	0 204 131 703 ^A		
FT 280 K/S 2.0 TDE						FBK,KZB,RSA	0 204 131 707 ^A		
		12.02-02.04	74/92			KZS,KZW	0 204 131 705 ^A		
		12.02-07.06	74/92			FBK,KZB,KZW	0 204 131 702 ^A		
		02.04-07.06	74/92			FBK,KZW,RSA	0 204 131 710 ^A		
FT 280 K/S 2.3i		08.01-07.06	103-107			FBK,KZB,KZE	0 204 131 703 ^A		
						FBK,KZG,KZW	0 204 131 706 ^A		
		12.02-07.06	103-107			FBK,KZW,ORA	0 204 131 704 ^A		
FT 280 K/S 2.4 TDE		04.01-07.06	66			FBK,KZB,KZE	0 204 131 703 ^A		
						FBK,KZG,KZW	0 204 131 706 ^A		
		12.02-07.06	66			FBK,KZW,ORA	0 204 131 704 ^A		
FT 280 L 2.3i		01.00-07.06	55/66/85/92/			FBK,KB2	0 204 131 701 ^A		
FT 280 L 2.4 TDE			103-107			FBK,KW2	0 204 131 711 ^A		
						FBK,KZB,KZE	0 204 131 703 ^A		
						FBK,KZB,KZW	0 204 131 702 ^A		
						FBK,KZB,RSA	0 204 131 707 ^A		
						FBK,KZG,KZW	0 204 131 706 ^A		
						FBK,KZW,RSA	0 204 131 710 ^A		
						KZS,KZW	0 204 131 705 ^A		
		12.02-07.06	55/66/85/92/103-107			FBK,KZW,ORA	0 204 131 704 ^A		
FT 280 M 2.0 TD		08.00-12.02	55/63			FBK,KB2	0 204 131 701 ^A		
FT 280 M 2.0 TDE		12.02-02.04	55/63			KZS,KZW	0 204 131 705 ^A		
		12.02-07.06	55/63			FBK,KZB,KZE	0 204 131 703 ^A		
						FBK,KZB,KZW	0 204 131 702 ^A		
		02.04-07.06	55/63			FBK,KZW,RSA	0 204 131 710 ^A		
FT 280 M 2.0 TDCi, 2.0 TDE		08.00-12.02	74/92			FBK,KB2	0 204 131 701 ^A		
		12.02-02.04	74/92			KZS,KZW	0 204 131 705 ^A		
		12.02-07.06	74/92			FBK,KZB,KZE	0 204 131 703 ^A		
						FBK,KZB,KZW	0 204 131 702 ^A		
		02.04-07.06	74/92			FBK,KZW,RSA	0 204 131 710 ^A		
FT 280 M 2.3i		08.01-07.06	103-107			FBK,KZB,KZE	0 204 131 703 ^A		
		12.02-07.06	103-107			FBK,KZG,KZW	0 204 131 706 ^A		
						FBK,KZW,ORA	0 204 131 704 ^A		
FT 280 M 2.4 TDE		04.01-07.06	66			FBK,KZB,KZE	0 204 131 703 ^A		
		12.02-07.06	66			FBK,KZG,KZW	0 204 131 706 ^A		
						FBK,KZW,ORA	0 204 131 704 ^A		
FT 280 S 2.4 TDI		01.01-05.06	66			FBK,KW2	0 204 131 711 ^A		
		12.02-02.04	66			FBK,KZB,KZE	0 204 131 703 ^A		
		12.02-05.06	66			FBK,KZG,KZW	0 204 131 706 ^A		
FT 300 K/S 2.0 TD		08.00-07.06	55/63/74/92			FBK,KZB,KZE	0 204 131 703 ^A		
FT 300 K/S 2.0 TDCi		12.02-02.04	55/63/74/92			KZS,KZW	0 204 131 705 ^A		
FT 300 K/S 2.0 TDE		12.02-07.06	55/63/74/92			FBK,KW2	0 204 131 711 ^A		
			92			FBK,KZW,ORA	0 204 131 704 ^A		
		02.04-07.06	55/63/74/92			FBK,KZW,RSA	0 204 131 710 ^A		
FT 300 K/S 2.3i		08.00-07.06	107			FBK,KW2	0 204 131 711 ^A		
						FBK,KZG,KZW	0 204 131 706 ^A		
		12.02-07.06	107			FBK,KZB,KZE	0 204 131 703 ^A		
FT 300 L 2.0 TD		08.00-07.06	55/63/74/92			FBK,KZB,KZE	0 204 131 703 ^A		
FT 300 L 2.0 TDCi		12.02-02.04	55/63/74/92			KZS,KZW	0 204 131 705 ^A		
FT 300 L 2.0 TDE		02.04-07.06	55/63/74/92			FBK,KZW,RSA	0 204 131 710 ^A		
FT 300 L 2.3i		08.00-12.02	107			FBK,KZB,KZW	0 204 131 702 ^A		
		12.02-07.06	107			FBK,KZB,KZE	0 204 131 703 ^A		
						FBK,KZB,RSA	0 204 131 707 ^A		
						FBK,KZG,KZW	0 204 131 706 ^A		
						FBK,KZW,ORA	0 204 131 704 ^A		



		S							
◀ FORD Transit [00]									
FT 300 M 2.0 TD	08.00-07.06	55/63/74/92				FBK,KZB,KZE	0 204 131 703 ^A		
FT 300 M 2.0 TDCi	12.02-02.04	55/63/74/92				KZS,KZW	0 204 131 705 ^A		
FT 300 M 2.0 TDE	12.02-07.06	55/63/74/ 92				FBK,KZW,ORA FBK,KZW,RSA	0 204 131 704 ^A 0 204 131 710 ^A		
FT 300 M 2.3i	08.00-07.06	107				FBK,KZB,KZW FBK,KZG,KZW	0 204 131 702 ^A 0 204 131 706 ^A		
	12.02-02.04	107				KZS,KZW	0 204 131 705 ^A		
	12.02-07.06	107				FBK,KZB,KZE FBK,KZW,ORA	0 204 131 703 ^A 0 204 131 704 ^A		
FT 300 S 2.0 TDCi	05.02-05.06	92				FBK,KZB,KZE	0 204 131 703 ^A		
	12.02-02.04	92				KZS,KZW	0 204 131 705 ^A		
	12.02-05.06	92				FBK,KW2 FBK,KZW,ORA	0 204 131 711 ^A 0 204 131 704 ^A		
FT 300 S 2.4 TDI	01.01-05.06	66/74				FBK,KW2 FBK,KZW,ORA	0 204 131 711 ^A 0 204 131 704 ^A		
	12.02-02.04	66/74				FBK,KZB,KZE	0 204 131 703 ^A		
	12.02-05.06	66/74				FBK,KZG,KZW	0 204 131 706 ^A		
FT 310 S 2.4 TDI	01.01-05.06	88				FBK,KW2 FBK,KZW,ORA	0 204 131 711 ^A 0 204 131 704 ^A		
	12.02-02.04	88				FBK,KZB,KZE	0 204 131 703 ^A		
	12.02-05.06	88				FBK,KZG,KZW	0 204 131 706 ^A		
FT 330 K/S 2.0 TDCi	05.02-07.06	92				FBK,KZB,KZE	0 204 131 703 ^A		
	12.02-02.04	92				KZS,KZW	0 204 131 705 ^A		
	12.02-07.06	92				FBK,KZW,ORA FBK,KZW,RSA	0 204 131 704 ^A 0 204 131 710 ^A		
FT 330 K/S 2.0 TDE	08.03-02.04	74				KZS,KZW	0 204 131 705 ^A		
	08.03-07.06	74				FBK,KZB,KZE FBK,KZW,ORA FBK,KZW,RSA	0 204 131 703 ^A 0 204 131 704 ^A 0 204 131 710 ^A		
FT 330 K/S 2.3i	12.00-07.06	103-107				FBK,KB2 FBK,KZA,KZW FBK,KZW,ORA	0 204 131 701 ^A 0 204 131 708 ^A 0 204 131 704 ^A		
	12.02-02.04	103-107				FBK,KZW,RSA	0 204 131 710 ^A		
	12.02-07.06	103-107				FBK,KZB,KZE FBK,KZG,KZW	0 204 131 703 ^A 0 204 131 706 ^A		
FT 330 K/S 2.4 TD	01.00-07.06	55/66				FBK,KB2	0 204 131 701 ^A		
FT 330 K/S 2.4 TDE						FBK,KZA,KZW FBK,KZW,ORA	0 204 131 708 ^A 0 204 131 704 ^A		
	12.02-02.04	55/66				FBK,KZW,RSA	0 204 131 710 ^A		
	12.02-07.06	55/66				FBK,KZB,KZE FBK,KZG,KZW	0 204 131 703 ^A 0 204 131 706 ^A		
FT 330 K/S 2.4 TDCi	03.04-07.06	101				FBK,KB2 FBK,KZA,KZW FBK,KZB,KZE FBK,KZG,KZW FBK,KZW,ORA	0 204 131 701 ^A 0 204 131 708 ^A 0 204 131 703 ^A 0 204 131 706 ^A 0 204 131 704 ^A		
FT 330 K/S 2.4 TDE	01.00-07.06	88				FBK,KB2 FBK,KZA,KZW FBK,KZW,ORA	0 204 131 701 ^A 0 204 131 708 ^A 0 204 131 704 ^A		
		92				FBK,KB2 FBK,KZA,KZW FBK,KZW,ORA	0 204 131 701 ^A 0 204 131 708 ^A 0 204 131 704 ^A		
	12.02-02.04	88				FBK,KZW,RSA	0 204 131 710 ^A		
		92				FBK,KZW,RSA	0 204 131 710 ^A		
	12.02-07.06	88				FBK,KZB,KZE FBK,KZG,KZW	0 204 131 703 ^A 0 204 131 706 ^A		
		92				FBK,KZB,KZE FBK,KZG,KZW	0 204 131 703 ^A 0 204 131 706 ^A		
	03.04-07.06	85				FBK,KB2 FBK,KZA,KZW FBK,KZB,KZE FBK,KZG,KZW FBK,KZW,ORA	0 204 131 701 ^A 0 204 131 708 ^A 0 204 131 703 ^A 0 204 131 706 ^A 0 204 131 704 ^A		











		S								
FT 330 L 2.0 TDCi	12.02-02.04	92				KZS,KZW	0 204 131 705 ^A			
	12.02-07.06	92				FBK,KZA,KZW	0 204 131 708 ^A			
	02.04-07.06	92				FBK,KZW,RSA	0 204 131 710 ^A			
FT 330 L 2.0 TDCi	01.00-07.06	92				FBK,KZB,KZE	0 204 131 703 ^A			
FT 330 L 2.4 TDE	12.02-07.06	92				FBK,KZW,ORA	0 204 131 704 ^A			
FT 330 L 2.0 TDE	08.03-02.04	74				KZS,KZW	0 204 131 705 ^A			
	08.03-07.06	74				FBK,KZA,KZW	0 204 131 708 ^A			
						FBK,KZB,KZE	0 204 131 703 ^A			
						FBK,KZW,ORA	0 204 131 704 ^A			
02.04-07.06	74				FBK,KZW,RSA	0 204 131 710 ^A				
FT 330 L 2.3i	12.00-12.02	103-107				KZS,KZW	0 204 131 705 ^A			
	12.00-07.06	103-107				FBK,KW2	0 204 131 711 ^A			
						FBK,KZB,KZE	0 204 131 703 ^A			
12.02-07.06	103-107				FBK,KZG,KZW	0 204 131 706 ^A				
						FBK,KZW,ORA	0 204 131 704 ^A			
FT 330 L 2.4 TD	01.00-12.02	55				KZS,KZW	0 204 131 705 ^A			
	01.00-09.03	55				FBK,KW2	0 204 131 711 ^A			
						FBK,KZB,KZE	0 204 131 703 ^A			
	12.02-09.03	55				FBK,KZG,KZW	0 204 131 706 ^A			
						FBK,KZW,ORA	0 204 131 704 ^A			
FT 330 L 2.4 TDCi	03.04-07.06	101				FBK,KW2	0 204 131 711 ^A			
						FBK,KZB,KZE	0 204 131 703 ^A			
						FBK,KZG,KZW	0 204 131 706 ^A			
						FBK,KZW,ORA	0 204 131 704 ^A			
FT 330 L 2.4 TDE	01.00-12.02	66				KZS,KZW	0 204 131 705 ^A			
						KZS,KZW	0 204 131 705 ^A			
						KZS,KZW	0 204 131 705 ^A			
	01.00-07.06	66					FBK,KW2	0 204 131 711 ^A		
						FBK,KW2	0 204 131 711 ^A			
						FBK,KW2	0 204 131 711 ^A			
	12.02-07.06	66					FBK,KZG,KZW	0 204 131 706 ^A		
						FBK,KZW,ORA	0 204 131 704 ^A			
						FBK,KZG,KZW	0 204 131 706 ^A			
						FBK,KZW,ORA	0 204 131 704 ^A			
	03.04-07.06	85					FBK,KZG,KZW	0 204 131 706 ^A		
						FBK,KW2	0 204 131 711 ^A			
						FBK,KZB,KZE	0 204 131 703 ^A			
						FBK,KZG,KZW	0 204 131 706 ^A			
						FBK,KZW,ORA	0 204 131 704 ^A			
FT 330 L 2.4 TDE	01.00-07.06	66				FBK,KZB,KZE	0 204 131 703 ^A			
FT 330 L 2.4 TDI		88				FBK,KZB,KZE	0 204 131 703 ^A			
FT 330 L 2.4 TDI	01.01-05.06	66				FBK,KZW,ORA	0 204 131 704 ^A			
						FBK,KZW,ORA	0 204 131 704 ^A			
	12.02-02.04	66					FBK,KW2	0 204 131 711 ^A		
						FBK,KW2	0 204 131 711 ^A			
	12.02-05.06	66					FBK,KZG,KZW	0 204 131 706 ^A		
		88					FBK,KZG,KZW	0 204 131 706 ^A		
FT 330 M 2.0 TDCi	12.02-02.04	92				KZS,KZW	0 204 131 705 ^A			
	12.02-07.06	92				FBK,KZA,KZW	0 204 131 708 ^A			
						FBK,KZW,ORA	0 204 131 704 ^A			
02.04-07.06	92					FBK,KZW,RSA	0 204 131 710 ^A			
FT 330 M 2.0 TDCi, 2.4 TDE	01.00-07.06	92				FBK,KZB,KZE	0 204 131 703 ^A			
FT 330 M 2.0 TDE	08.03-02.04	74				KZS,KZW	0 204 131 705 ^A			
						FBK,KZA,KZW	0 204 131 708 ^A			
	08.03-07.06	74					FBK,KZB,KZE	0 204 131 703 ^A		
						FBK,KZW,ORA	0 204 131 704 ^A			
02.04-07.06	74					FBK,KZW,RSA	0 204 131 710 ^A			
FT 330 M 2.3i	12.00-02.04	103-107				KZS,KZW	0 204 131 705 ^A			
	12.00-07.06	103-107				FBK,KZB,KZE	0 204 131 703 ^A			
						FBK,KZW,ORA	0 204 131 704 ^A			
12.02-07.06	103-107					FBK,KZG,KZW	0 204 131 706 ^A			



		S							
◀ FORD Transit [00]									
FT 330 M 2.4 TD	01.00-09.03	55		FBK,KZB,KZE	0 204 131 703 ^A				
				FBK,KZW,ORA	0 204 131 704 ^A				
				KZS,KZW	0 204 131 705 ^A				
	12.02-09.03	55		FBK,KZG,KZW	0 204 131 706 ^A				
FT 330 M 2.4 TDCi	03.04-07.06	101		FBK,KZB,KZE	0 204 131 703 ^A				
				FBK,KZG,KZW	0 204 131 706 ^A				
				FBK,KZW,ORA	0 204 131 704 ^A				
FT 330 M 2.4 TDE	01.00-02.04	66		KZS,KZW	0 204 131 705 ^A				
				KZS,KZW	0 204 131 705 ^A				
				KZS,KZW	0 204 131 705 ^A				
	01.00-07.06	66		FBK,KZB,KZE	0 204 131 703 ^A				
				FBK,KZB,KZE	0 204 131 703 ^A				
				FBK,KZW,ORA	0 204 131 704 ^A				
	12.02-07.06	66		FBK,KZG,KZW	0 204 131 706 ^A				
				FBK,KZG,KZW	0 204 131 706 ^A				
				FBK,KZG,KZW	0 204 131 706 ^A				
03.04-07.06	85		FBK,KZB,KZE	0 204 131 703 ^A					
			FBK,KZG,KZW	0 204 131 706 ^A					
			FBK,KZW,ORA	0 204 131 704 ^A					
FT 330 M 2.4 TDE	01.00-07.06	66		FBK,KZW,ORA	0 204 131 704 ^A				
FT 330 M 2.4 TDI		88		FBK,KZW,ORA	0 204 131 704 ^A				
FT 330 M 2.4 TDI	01.01-05.06	66		FBK,KZG,KZW	0 204 131 706 ^A				
				KZS,KZW	0 204 131 705 ^A				
		88		FBK,KZG,KZW	0 204 131 706 ^A				
				KZS,KZW	0 204 131 705 ^A				
	12.02-02.04	66		FBK,KZB,KZE	0 204 131 703 ^A				
FT 330 S 2.4 TDI	01.01-02.04	66/74/88		FBK,KZB,KZE	0 204 131 703 ^A				
				FBK,KB2	0 204 131 701 ^A				
	01.01-05.06	66/74/88		FBK,KZA,KZW	0 204 131 708 ^A				
				FBK,KZW,ORA	0 204 131 704 ^A				
	12.02-05.06	66/74/88		FBK,KZG,KZW	0 204 131 706 ^A				
			FBK,KZW,RSA	0 204 131 710 ^A					
FT 350 EL 2.0 TDCi	05.02-07.06	92		FBK,KZW,ORA	0 204 131 704 ^A				
				KZS,KZW	0 204 131 705 ^A				
	02.04-07.06	92		FBK,KZW,RSA	0 204 131 710 ^A				
FT 350 EL 2.0 TDCi, 2.4 TDE	01.00-07.06	92		FBK,KZB,KZE	0 204 131 703 ^A				
FT 350 EL 2.0 TDE	08.03-02.04	74		KZS,KZW	0 204 131 705 ^A				
				FBK,KZB,KZE	0 204 131 703 ^A				
	02.04-07.06	74		FBK,KZW,ORA	0 204 131 704 ^A				
				FBK,KZW,RSA	0 204 131 710 ^A				
FT 350 EL 2.3i	12.00-12.02	103-107		FBK,KW2	0 204 131 711 ^A				
				FBK,KZW,RSA	0 204 131 710 ^A				
	12.00-02.04	103-107		KZS,KZW	0 204 131 705 ^A				
				FBK,KZB,KZE	0 204 131 703 ^A				
				FBK,KZG,KZW	0 204 131 706 ^A				
	12.02-07.06	103-107		FBK,KZW,ORA	0 204 131 704 ^A				
FT 350 EL 2.4 TD	01.00-12.02	55/66		FBK,KW2	0 204 131 711 ^A				
FT 350 EL 2.4 TDE	01.00-02.04	55/66		KZS,KZW	0 204 131 705 ^A				
				FBK,KZB,KZE	0 204 131 703 ^A				
	12.02-07.06	55/66		FBK,KZG,KZW	0 204 131 706 ^A				
				FBK,KZW,ORA	0 204 131 704 ^A				
FT 350 EL 2.4 TDCi	03.04-07.06	101		FBK,KZB,KZE	0 204 131 703 ^A				
				FBK,KZG,KZW	0 204 131 706 ^A				
				FBK,KZW,ORA	0 204 131 704 ^A				
FT 350 EL 2.4 TDE	01.00-12.02	92		FBK,KW2	0 204 131 711 ^A				
				FBK,KZW,RSA	0 204 131 710 ^A				
	01.00-02.04	92		KZS,KZW	0 204 131 705 ^A				
	12.02-07.06	92		FBK,KZG,KZW	0 204 131 706 ^A				
				FBK,KZW,ORA	0 204 131 704 ^A				











									
FT 350 EL 2.4 TDE	03.04-07.06	85	FBK,KZB,KZE	0 204 131 703 ^A					
			FBK,KZG,KZW	0 204 131 706 ^A					
			FBK,KZW,ORA	0 204 131 704 ^A					
FT 350 E 2.4 TDI	01.01-05.06	66/88/96	FBK,KZB,KZE	0 204 131 703 ^A					
	12.02-05.06	66/88/96	FBK,KZW,ORA	0 204 131 704 ^A					
FT 350 L 2.0 TDCi	05.02-07.06	92	FBK,KZA,KZE	0 204 131 709 ^A					
	12.02-02.04	92	FBK,KZA,KZW	0 204 131 708 ^A					
	12.02-07.06	92	KZS,KZW	0 204 131 705 ^A					
			FBK,KZB,KZE	0 204 131 703 ^A					
			FBK,KZW,ORA	0 204 131 704 ^A					
07.03-07.06	92	FBK,KZW,RSA	0 204 131 710 ^A						
FT 350 L 2.0 TDE	08.03-02.04	74	FBK,KB2	0 204 131 701 ^A					
	08.03-07.06	74	FBK,KZA,KZW	0 204 131 708 ^A					
			KZS,KZW	0 204 131 705 ^A					
			FBK,KZA,KZE	0 204 131 709 ^A					
			FBK,KZB,KZE	0 204 131 703 ^A					
12.00-12.02	103-107	FBK,KZW,ORA	0 204 131 704 ^A						
FT 350 L 2.3i	12.00-12.02	103-107	FBK,KZW,RSA	0 204 131 710 ^A					
			FBK,KW2	0 204 131 711 ^A					
	12.00-07.06	103-107	FBK,KZA,KZE	0 204 131 709 ^A					
			FBK,KZB,KZE	0 204 131 703 ^A					
			FBK,KZW,ORA	0 204 131 704 ^A					
12.02-07.06	103-107	FBK,KZG,KZW	0 204 131 706 ^A						
KZS,KZW	0 204 131 705 ^A								
FT 350 L 2.4 TD	01.00-12.02	55	FBK,KW2	0 204 131 711 ^A					
			FBK,KZW,RSA	0 204 131 710 ^A					
	01.00-09.03	55	FBK,KZA,KZE	0 204 131 709 ^A					
			FBK,KZB,KZE	0 204 131 703 ^A					
			FBK,KZW,ORA	0 204 131 704 ^A					
12.02-09.03	55	FBK,KZG,KZW	0 204 131 706 ^A						
KZS,KZW	0 204 131 705 ^A								
FT 350 L 2.4 TDCi	03.04-07.06	101	FBK,KZA,KZE	0 204 131 709 ^A					
			FBK,KZB,KZE	0 204 131 703 ^A					
			FBK,KZG,KZW	0 204 131 706 ^A					
			FBK,KZW,ORA	0 204 131 704 ^A					
			KZS,KZW	0 204 131 705 ^A					
FT 350 L 2.4 TDE	01.00-12.02	66	FBK,KW2	0 204 131 711 ^A					
			FBK,KZW,RSA	0 204 131 710 ^A					
			88	FBK,KW2	0 204 131 711 ^A				
			FBK,KZW,RSA	0 204 131 710 ^A					
	92	FBK,KW2	0 204 131 711 ^A						
	FBK,KZW,RSA	0 204 131 710 ^A							
	01.00-07.06	66	FBK,KZA,KZE	0 204 131 709 ^A					
			FBK,KZW,ORA	0 204 131 704 ^A					
			88	FBK,KZA,KZE	0 204 131 709 ^A				
			FBK,KZW,ORA	0 204 131 704 ^A					
			92	FBK,KZA,KZE	0 204 131 709 ^A				
			FBK,KZB,KZE	0 204 131 703 ^A					
	FBK,KZW,ORA	0 204 131 704 ^A							
	12.02-07.06	66	FBK,KZG,KZW	0 204 131 706 ^A					
			88	FBK,KZG,KZW	0 204 131 706 ^A				
			92	FBK,KZG,KZW	0 204 131 706 ^A				
	KZS,KZW	0 204 131 705 ^A							
	03.04-07.06	85	FBK,KZA,KZE	0 204 131 709 ^A					
			FBK,KZB,KZE	0 204 131 703 ^A					
			FBK,KZG,KZW	0 204 131 706 ^A					
FBK,KZW,ORA			0 204 131 704 ^A						
KZS,KZW			0 204 131 705 ^A						



		S							
◀ FORD Transit [00]									
FT 350 L 2.4 TDE		01.00-07.06	66			FBK,KZB,KZE	0 204 131 703 ^A		
FT 350 L 2.4 TDI			88			FBK,KZB,KZE	0 204 131 703 ^A		
		12.02-07.06	66			KZS,KZW	0 204 131 705 ^A		
			88			KZS,KZW	0 204 131 705 ^A		
FT 350 L 2.4 TDI		12.02-02.04	66			FBK,KZA,KZW	0 204 131 708 ^A		
			88			FBK,KZA,KZW	0 204 131 708 ^A		
		12.02-05.06	66			FBK,KZA,KZE	0 204 131 709 ^A		
						FBK,KZG,KZW	0 204 131 706 ^A		
						FBK,KZW,ORA	0 204 131 704 ^A		
						FBK,KZW,RSA	0 204 131 710 ^A		
			88			FBK,KZA,KZE	0 204 131 709 ^A		
						FBK,KZG,KZW	0 204 131 706 ^A		
						FBK,KZW,ORA	0 204 131 704 ^A		
						FBK,KZW,RSA	0 204 131 710 ^A		
		06.04-05.06	96			FBK,KZA,KZE	0 204 131 709 ^A		
						FBK,KZB,KZE	0 204 131 703 ^A		
						FBK,KZG,KZW	0 204 131 706 ^A		
						FBK,KZW,ORA	0 204 131 704 ^A		
						FBK,KZW,RSA	0 204 131 710 ^A		
						KZS,KZW	0 204 131 705 ^A		
FT 350 M 2.0 TDCi		05.02-07.06	92			FBK,KZW,ORA	0 204 131 704 ^A		
						KZS,KZW	0 204 131 705 ^A		
		02.04-07.06	92			FBK,KZW,RSA	0 204 131 710 ^A		
FT 350 M 2.0 TDCi, 2.4 TDE		01.00-07.06	92			FBK,KZB,KZE	0 204 131 703 ^A		
FT 350 M 2.0 TDE		08.03-07.06	74			FBK,KZB,KZE	0 204 131 703 ^A		
						FBK,KZW,ORA	0 204 131 704 ^A		
						KZS,KZW	0 204 131 705 ^A		
		02.04-07.06	74			FBK,KZW,RSA	0 204 131 710 ^A		
FT 350 M 2.3i		12.00-02.04	103-107			FBK,KW2	0 204 131 711 ^A		
						KZS,KZW	0 204 131 705 ^A		
		12.00-07.06	103-107			FBK,KZB,KZE	0 204 131 703 ^A		
		12.02-07.06	103-107			FBK,KZG,KZW	0 204 131 706 ^A		
						FBK,KZW,ORA	0 204 131 704 ^A		
FT 350 M 2.4 TD		01.00-09.03	55			FBK,KW2	0 204 131 711 ^A		
						FBK,KZB,KZE	0 204 131 703 ^A		
						KZS,KZW	0 204 131 705 ^A		
		12.02-09.03	55			FBK,KZG,KZW	0 204 131 706 ^A		
						FBK,KZW,ORA	0 204 131 704 ^A		
FT 350 M 2.4 TDCi		03.04-07.06	101			FBK,KZB,KZE	0 204 131 703 ^A		
						FBK,KZG,KZW	0 204 131 706 ^A		
						FBK,KZW,ORA	0 204 131 704 ^A		
FT 350 M 2.4 TDE		01.00-02.04	66			FBK,KW2	0 204 131 711 ^A		
			88			KZS,KZW	0 204 131 705 ^A		
						FBK,KW2	0 204 131 711 ^A		
						KZS,KZW	0 204 131 705 ^A		
			92			FBK,KW2	0 204 131 711 ^A		
						KZS,KZW	0 204 131 705 ^A		
		01.00-07.06	66			FBK,KZB,KZE	0 204 131 703 ^A		
			88			FBK,KZB,KZE	0 204 131 703 ^A		
		12.02-07.06	92			FBK,KZG,KZW	0 204 131 706 ^A		
						FBK,KZW,ORA	0 204 131 704 ^A		
		03.04-07.06	85			FBK,KZB,KZE	0 204 131 703 ^A		
						FBK,KZG,KZW	0 204 131 706 ^A		
						FBK,KZW,ORA	0 204 131 704 ^A		
FT 350 M 2.4 TDE		12.02-07.06	66			FBK,KZG,KZW	0 204 131 706 ^A		
FT 350 M 2.4 TDI			88			FBK,KZW,ORA	0 204 131 704 ^A		
						FBK,KZG,KZW	0 204 131 706 ^A		
						FBK,KZW,ORA	0 204 131 704 ^A		
FT 350 M 2.4 TDI		01.01-05.06	66			FBK,KW2	0 204 131 711 ^A		
						KZS,KZW	0 204 131 705 ^A		
			88			FBK,KW2	0 204 131 711 ^A		
						KZS,KZW	0 204 131 705 ^A		



		S								
FT 350 M 2.4 TDI	12.02-02.04	66				FBK,KZB,KZE	0 204 131 703 ^A			
		88				FBK,KZB,KZE	0 204 131 703 ^A			
	06.04-05.06	96				FBK,KW2	0 204 131 711 ^A			
						FBK,KZG,KZW	0 204 131 706 ^A			
						FBK,KZW,ORA	0 204 131 704 ^A			
FT 430 EL 2.4 TD	08.02-07.06	55/66/85/				FBK,KZB,KZE	0 204 131 703 ^A			
		92/101				FBK,KZW,ORA	0 204 131 704 ^A			
	12.02-07.06	55/66/85/92/101				FBK,KZG,KZW	0 204 131 706 ^A			
	FT 430 E 2.4 TDI	06.04-05.06	96				FBK,KZB,KZE	0 204 131 703 ^A		
							FBK,KZG,KZW	0 204 131 706 ^A		
					FBK,KZW,ORA	0 204 131 704 ^A				
					KZS,KZW	0 204 131 705 ^A				
FT 430 M 2.4 TD	08.02-07.06	55/85/92/				FBK,KZB,KZE	0 204 131 703 ^A			
		101				FBK,KZW,ORA	0 204 131 704 ^A			
	12.02-07.06	55/85/92/101				FBK,KZG,KZW	0 204 131 706 ^A			
FT 240 K/S 2.0 TD	08.00-07.06	55/63					0 265 216 673 ^B			
							0 265 220 539 ^F			
FT 260 K/S 2.0 TD	08.00-07.06	55/63					0 265 216 673 ^B			
							0 265 220 539 ^F			
FT 260 K/S 2.0 TDCi	08.00-07.06	74/92					0 265 216 673 ^B			
							0 265 220 539 ^F			
FT 260 K/S 2.0 TDE	08.01-07.06	103-107					0 265 220 487 ^F			
	04.01-07.06	66					0 265 220 487 ^F			
FT 280 K/S 2.0 TD	08.00-07.06	55/63					0 265 216 673 ^B			
							0 265 220 539 ^F			
FT 280 K/S 2.0 TDCi	08.00-07.06	74/92					0 265 216 673 ^B			
							0 265 220 539 ^F			
FT 280 K/S 2.3i	08.01-07.06	103-107					0 265 220 487 ^F			
	04.01-07.06	66					0 265 220 487 ^F			
FT 280 K/S 2.4 TDE	01.00-07.06	55/66/85/92/103-107					0 265 220 487 ^F			
	08.00-07.06	55/63					0 265 216 673 ^B			
FT 280 M 2.0 TD	08.00-07.06	74/92					0 265 220 539 ^F			
							0 265 216 673 ^B			
FT 280 M 2.0 TDCi	08.01-07.06	103-107					0 265 220 487 ^F			
	04.01-07.06	66					0 265 220 487 ^F			
FT 280 M 2.0 TDE	01.00-07.06	55/66/85/92/103-107					0 265 220 487 ^F			
	08.00-07.06	55/63					0 265 216 673 ^B			
FT 280 M 2.0 TDCi	08.00-07.06	74/92					0 265 220 539 ^F			
							0 265 216 673 ^B			
FT 280 M 2.3i	08.01-07.06	103-107					0 265 220 487 ^F			
	04.01-07.06	66					0 265 220 487 ^F			
FT 280 M 2.4 TDE	01.00-07.06	55/66/85/92/103-107					0 265 220 487 ^F			
	08.00-07.06	55/63					0 265 216 673 ^B			
FT 280 S 2.4 TDI	08.00-07.06	74/92					0 265 220 539 ^F			
							0 265 216 673 ^B			
FT 300 K/S 2.0 TD, 2.0 TDCi, 2.0 TDE	08.00-07.06	103-107					0 265 220 487 ^F			
							0 265 220 539 ^F			
FT 300 K/S 2.3i	08.00-07.06	107					0 265 220 487 ^F			
							0 265 220 487 ^F			
FT 300 L 2.0 TD, 2.0 TDCi, 2.0 TDE	08.00-07.06	55/63/74/					0 265 216 673 ^B			
		92					0 265 220 539 ^F			
FT 300 L 2.3i	08.00-07.06	107					0 265 220 487 ^F			
							0 265 220 487 ^F			
FT 300 M 2.0 TD, 2.0 TDCi, 2.0 TDE	08.00-07.06	55/63/74/					0 265 216 673 ^B			
		92					0 265 220 539 ^F			
FT 300 M 2.3i	08.00-07.06	107					0 265 220 487 ^F			
							0 265 220 487 ^F			
FT 300 S 2.0 TDCi, 2.4 TDI	01.01-05.06	66/74/92				TW	0 265 216 673 ^B			
							0 265 216 673 ^B			
FT 310 S 2.4 TDI	01.01-05.06	88				TW	0 265 216 673 ^B			
							0 265 216 673 ^B			
FT 330 K/S 2.0 TDCi	05.02-07.06	92					0 265 216 999 ^B			
	07.03-07.06	92					0 265 220 693 ^F			
FT 330 K/S 2.0 TDE	08.03-07.06	74					0 265 216 999 ^B			
							0 265 220 693 ^F			
FT 330 K/S 2.3i, 2.4 TDCi	12.00-07.06	101/103-107					0 265 220 487 ^F			
							0 265 220 487 ^F			
FT 330 K/S 2.4 TD, 2.4 TDE	01.00-07.06	55/66					0 265 220 487 ^F			
							0 265 220 487 ^F			
FT 330 K/S 2.4 TDE	01.00-07.06	85/88					0 265 220 487 ^F			
		92					0 265 220 487 ^F			
FT 330 L 2.0 TDCi	05.02-07.06	92					0 265 216 999 ^B			
	07.03-07.06	92					0 265 220 693 ^F			
FT 330 L 2.0 TDE	08.03-07.06	74					0 265 216 999 ^B			
							0 265 220 693 ^F			
FT 330 L 2.3i, 2.4 TDCi	12.00-07.06	101/103-107					0 265 220 487 ^F			
							0 265 220 487 ^F			



		S							
◀ FORD Transit [00]									
FT 330 L 2.4 TD		01.00-09.03	55				0 265 220 487 ^F		
FT 330 L 2.4 TDE		01.00-07.06	66				0 265 220 487 ^F		
			88				0 265 220 487 ^F		
			92				0 265 220 487 ^F		
		03.04-07.06	85				0 265 220 487 ^F		
FT 330 L 2.4 TDI		01.01-05.06	66			TW	0 265 216 673 ^B		
			88			TW	0 265 216 673 ^B		
FT 330 M 2.0 TDCi		05.02-07.06	92				0 265 216 999 ^B		
		07.03-07.06	92				0 265 220 693 ^F		
FT 330 M 2.0 TDE		08.03-07.06	74				0 265 216 999 ^B		
							0 265 220 693 ^F		
FT 330 M 2.3i, 2.4 TDCi		12.00-07.06	101/103-107				0 265 220 487 ^F		
FT 330 M 2.4 TD		01.00-09.03	55				0 265 220 487 ^F		
FT 330 M 2.4 TDE		01.00-07.06	66				0 265 220 487 ^F		
			88				0 265 220 487 ^F		
			92				0 265 220 487 ^F		
		03.04-07.06	85				0 265 220 487 ^F		
FT 330 M 2.4 TDI		01.01-05.06	66			TW	0 265 216 673 ^B		
			88			TW	0 265 216 673 ^B		
FT 330 S 2.4 TDI		01.01-05.06	66/74/88			TW	0 265 216 673 ^B		
FT 350 EL 2.0 TDCi		05.02-07.06	92				0 265 216 999 ^B		
		07.03-07.06	92				0 265 220 693 ^F		
FT 350 EL 2.0 TDE		08.03-07.06	74				0 265 216 999 ^B		
							0 265 220 693 ^F		
FT 350 EL 2.3i, 2.4 TDCi		12.00-07.06	101/103-107				0 265 220 487 ^F		
FT 350 EL 2.4 TD, 2.4 TDE		01.00-07.06	55/66				0 265 220 487 ^F		
FT 350 EL 2.4 TDE		01.00-07.06	92				0 265 220 487 ^F		
		03.04-07.06	85				0 265 220 487 ^F		
FT 350 E 2.4 TDI		01.01-05.06	66/88/96			TW	0 265 216 673 ^B		
FT 350 L 2.0 TDCi		05.02-07.06	92				0 265 216 999 ^B		
		07.03-07.06	92				0 265 220 693 ^F		
FT 350 L 2.0 TDE		08.03-07.06	74				0 265 216 999 ^B		
							0 265 220 693 ^F		
FT 350 L 2.3i, 2.4 TDCi		12.00-07.06	101/103-107				0 265 220 487 ^F		
FT 350 L 2.4 TD		01.00-09.03	55				0 265 220 487 ^F		
FT 350 L 2.4 TDE		01.00-07.06	66				0 265 220 487 ^F		
			88				0 265 220 487 ^F		
			92				0 265 220 487 ^F		
		03.04-07.06	85				0 265 220 487 ^F		
FT 350 L 2.4 TDI		01.01-05.06	66			TW	0 265 216 673 ^B		
			88			TW	0 265 216 673 ^B		
		06.04-05.06	96			TW	0 265 216 673 ^B		
FT 350 M 2.0 TDCi		05.02-07.06	92				0 265 216 999 ^B		
		07.03-07.06	92				0 265 220 693 ^F		
FT 350 M 2.0 TDE		08.03-07.06	74				0 265 216 999 ^B		
							0 265 220 693 ^F		
FT 350 M 2.3i, 2.4 TDCi		12.00-07.06	101/103-107				0 265 220 487 ^F		
FT 350 M 2.4 TD		01.00-09.03	55				0 265 220 487 ^F		
FT 350 M 2.4 TDE		01.00-07.06	66				0 265 220 487 ^F		
			88				0 265 220 487 ^F		
			92				0 265 220 487 ^F		
		03.04-07.06	85				0 265 220 487 ^F		
FT 350 M 2.4 TDI		01.01-05.06	66			TW	0 265 216 673 ^B		
			88			TW	0 265 216 673 ^B		
		06.04-05.06	96			TW	0 265 216 673 ^B		
FT 430 EL 2.4 TD, 2.4 TDCi, 2.4 TDE		08.02-07.06	55/66/85/92/101				0 265 220 487 ^F		
FT 430 E 2.4 TDI		06.04-05.06	96			TW	0 265 216 673 ^B		
FT 430 M 2.4 TD, 2.4 TDCi, 2.4 TDE		08.02-07.06	55/85/92/101				0 265 220 487 ^F		





Transit [06]



	FT 260 2.2 TDCi	ABO	04.06-09.11	63/81/85/96-96/103		0 204 123 717	25,4
		ABS	04.06-09.11	63/81/85/96-96/103		0 204 123 716	25,4
	FT 280 2.2 TDCi	ABO	04.06-09.11	63/81/85/96-96/103		0 204 123 717	25,4
		ABS	04.06-09.11	63/81/85/96-96/103		0 204 123 716	25,4
	FT 300 2.2 TDCi, 2.3i, 2.4 TDCi	ABO	04.06-09.11	63/74-74/81/85/96/103/107		0 204 123 717	25,4
		ABS	04.06-09.11	63/74-74/81/85/96/103/107		0 204 123 716	25,4
	FT 330 2.2 TDCi, 2.3i, 2.3i CNG, 2.3i LPG, 2.4 TDCi, 2.4 TDCi 4x4	ABO	04.06-09.11	74-74/81/85-85/96/100-107		0 204 123 717	25,4
		ABS	04.06-09.11	74-74/81/85-85/96/100-107		0 204 123 716	25,4
	FT 350 2.2 TDCi, 2.3i, 2.3i CNG, 2.3i LPG, 2.4 TDCi, 2.4 TDCi 4x4, 3.2 TDCi	ABO	04.06-09.11	74-74/81/85-85/96/100-107/147		0 204 123 717	25,4
		ABS	04.06-09.11	74-74/81/85-85/96/100-107/147		0 204 123 716	25,4
	FT 430 2.4 TDCi	ABO	07.06-09.11	74-74/85-85/103		0 204 123 717	25,4
		ABS	07.06-09.11	74-74/85-85/103		0 204 123 716	25,4
	FT 460 2.4 TDCi	ABO	07.06-09.11	85/103/147		0 204 123 717	25,4
	FT 460 3.2 TDCi	ABS	07.06-09.11	85/103/147		0 204 123 716	25,4

	FT 260 2.2 TDCi		04.06-09.11	63/81/85/96-96/103		0 204 125 857	0 204 127 528
	FT 280 2.2 TDCi		04.06-09.11	63/81/85/96-96/103		0 204 125 857	0 204 127 528
	FT 300 2.2 TDCi, 2.3i, 2.4 TDCi		04.06-09.11	63/74-74/81/85/96/103/107		0 204 125 857	0 204 127 528
	FT 330 2.2 TDCi, 2.3i, 2.3i CNG, 2.3i LPG, 2.4 TDCi, 2.4 TDCi 4x4		04.06-09.11	74-74/81/85-85/96/100-107		0 204 125 857	0 204 127 528
	FT 350 2.2 TDCi, 2.3i, 2.3i CNG, 2.3i LPG, 2.4 TDCi, 2.4 TDCi 4x4, 3.2 TDCi		04.06-09.11	74-74/81/85-85/96/100-107/147		0 204 125 857	0 204 127 528
	FT 430 2.4 TDCi		07.06-09.11	74-74/85-85/103		0 204 125 857	0 204 127 528
	FT 460 2.4 TDCi, 3.2 TDCi		07.06-09.11	85/103/147		0 204 125 857	0 204 127 528

	FT 300 2.3i		04.06-09.11	107		F 026 A06 568	
	FT 300 2.4 TDCi		07.06-09.11	74-74/85	Get.-Nr. MT75 MG5	F 026 A06 568	
					Get.-Nr. MT82 MG6	0 986 486 612	28
	FT 330 2.3i CNG		04.06-09.11	100-107		F 026 A06 568	
	FT 330 2.3i, 2.3i LPG		04.06-09.11	107		F 026 A06 568	
	FT 330 2.4 TDCi		07.06-09.11	74-74/85-85	Get.-Nr. MT75 MG5	F 026 A06 568	
					Get.-Nr. MT82 MG6	0 986 486 612	28
	FT 330 2.4 TDCi		07.06-09.11	103	Get.-Nr. MT75 MG5	F 026 A06 568	
	FT 330 2.4 TDCi 4x4				Get.-Nr. MT82 MG6	0 986 486 612	28
	FT 350 2.3i CNG		04.06-09.11	100-107		F 026 A06 568	
	FT 350 2.3i, 2.3i LPG		04.06-09.11	107		F 026 A06 568	
	FT 350 2.4 TDCi		07.06-09.11	74-74/85-85	Get.-Nr. MT75 MG5	F 026 A06 568	
					Get.-Nr. MT82 MG6	0 986 486 612	28
	FT 350 2.4 TDCi		07.06-09.11	103	Get.-Nr. MT75 MG5	F 026 A06 568	
	FT 350 2.4 TDCi 4x4				Get.-Nr. MT82 MG6	0 986 486 612	28
	FT 430 2.4 TDCi		07.06-09.11	74-74/85-85/103	Get.-Nr. MT75 MG5	F 026 A06 568	
					Get.-Nr. MT82 MG6	0 986 486 612	28
	FT 460 2.4 TDCi		07.06-09.11	85/103	Get.-Nr. MT75 MG5	F 026 A06 568	
					Get.-Nr. MT82 MG6	0 986 486 612	28

	FT 280 2.2 TDCi		04.06-09.11	63/81/85/96-96/103	FBK,KZB,KZE	0 204 131 703^A			
					FBK,KZB,KZW	0 204 131 702^A			
	FT 300 2.2 TDCi		04.06-08.07	96	FBK,KW2	0 204 131 711^A			
					FBK,KZB,KZE	0 204 131 703^A			
					FBK,KZW,RSA	0 204 131 710^A			
					04.06-06.10	81	FBK,KW2	0 204 131 711^A	
							FBK,KZB,KZE	0 204 131 703^A	
							FBK,KZW,RSA	0 204 131 710^A	
			04.06-09.11	63	FBK,KW2	0 204 131 711^A			
					FBK,KZB,KZE	0 204 131 703^A			
FBK,KZW,RSA					0 204 131 710^A				
FBK,KZW,RSA					0 204 131 710^A				



		S							
◀ FORD Transit [06]									
FT 300 2.2 TDCi	10.07-09.11	103	FBK,KW2	0 204 131 711 ^A					
			FBK,KZB,KZE	0 204 131 703 ^A					
			FBK,KZW,RSA	0 204 131 710 ^A					
	10.08-09.11	85	FBK,KW2	0 204 131 711 ^A					
			FBK,KZB,KZE	0 204 131 703 ^A					
			FBK,KZW,RSA	0 204 131 710 ^A					
FT 300 2.3i	04.06-09.11	107	FBK,KW2	0 204 131 711 ^A					
			FBK,KZA,KZW	0 204 131 708 ^A					
			FBK,KZG,KZW	0 204 131 706 ^A					
			FBK,KZS,KZW	0 204 131 705 ^A					
FT 300 2.4 TDCi	07.06-09.11	74-74	FBK,KW2	0 204 131 711 ^A					
			FBK,KZB,KZW	0 204 131 702 ^A					
			FBK,KZG,KZW	0 204 131 706 ^A					
		85	FBK,KW2	0 204 131 711 ^A					
			FBK,KZA,KZW	0 204 131 708 ^A					
			FBK,KZG,KZW	0 204 131 706 ^A					
	07.06-09.11	74-74	FBK,KZS,KZW	0 204 131 705 ^A					
			FBK,KW2	0 204 131 711 ^A					
			FBK,KZB,KZW	0 204 131 702 ^A					
FT 330 2.2 TDCi	04.06-08.07	96	FBK,KB2	0 204 131 701 ^A					
			FBK,KZA,KZW	0 204 131 708 ^A					
			FBK,KZS,KZW	0 204 131 705 ^A					
		04.06-09.11	81/85	FBK,KZW,RSA	0 204 131 710 ^A				
				FBK,KB2	0 204 131 701 ^A				
				FBK,KZA,KZW	0 204 131 708 ^A				
		10.07-09.11	103	FBK,KZS,KZW	0 204 131 705 ^A				
				FBK,KZW,RSA	0 204 131 710 ^A				
				FBK,KB2	0 204 131 701 ^A				
	04.06-09.11	81/85	FBK,KZS,KZW	0 204 131 705 ^A					
			FBK,KZW,RSA	0 204 131 710 ^A					
			FBK,KB2	0 204 131 701 ^A					
FT 330 2.2 TDCi, 2.4 TDCi, 2.4 TDCi 4x4	07.06-09.11	103	FBK,KZA,KZW	0 204 131 708 ^A					
			FBK,KZS,KZW	0 204 131 705 ^A					
FT 330 2.3i CNG	04.06-09.11	100-107	FBK,KW2	0 204 131 711 ^A					
			FBK,KZA,KZW	0 204 131 708 ^A					
			FBK,KZG,KZW	0 204 131 706 ^A					
			FBK,KZS,KZW	0 204 131 705 ^A					
FT 330 2.3i	04.06-09.11	107	FBK,KW2	0 204 131 711 ^A					
			FBK,KZA,KZW	0 204 131 708 ^A					
FT 330 2.3i LPG	04.06-09.11	107	FBK,KZG,KZW	0 204 131 706 ^A					
			FBK,KZS,KZW	0 204 131 705 ^A					
			FBK,KZA,KZW	0 204 131 708 ^A					
FT 330 2.4 TDCi	07.06-09.11	74-74	FBK,KW2	0 204 131 711 ^A					
			FBK,KZA,KZW	0 204 131 708 ^A					
			FBK,KZG,KZW	0 204 131 706 ^A					
		85-85	FBK,KZS,KZW	0 204 131 705 ^A					
			FBK,KW2	0 204 131 711 ^A					
			FBK,KZA,KZW	0 204 131 708 ^A					
	07.06-09.11	103	FBK,KZG,KZW	0 204 131 706 ^A					
			FBK,KZS,KZW	0 204 131 705 ^A					
			FBK,KW2	0 204 131 711 ^A					
FT 330 2.4 TDCi 4x4	07.06-09.11	103	FBK,KZG,KZW	0 204 131 706 ^A					
			FBK,KZS,KZW	0 204 131 705 ^A					
FT 350 2.2 TDCi	04.06-08.07	96	FBK,KZW,RSA	0 204 131 710 ^A					
			FBK,KZW,RSA	0 204 131 710 ^A					
FT 350 2.2 TDCi, 2.4 TDCi, 2.4 TDCi 4x4	07.06-09.11	103	FBK,KZW,RSA	0 204 131 710 ^A					
			FBK,KZS,KZW	0 204 131 705 ^A					
FT 350 2.3i CNG	04.06-09.11	100-107	FBK,KZB,KZE	0 204 131 703 ^A					
			FBK,KZG,KZW	0 204 131 706 ^A					
			FBK,KZS,KZW	0 204 131 705 ^A					
			FBK,KZW,ORA	0 204 131 704 ^A					
			FBK,KZW,RSA	0 204 131 710 ^A					
			FBK,KZS,KZW	0 204 131 705 ^A					
FT 350 2.3i	04.06-09.11	107/147	FBK,KZB,KZE	0 204 131 703 ^A					
			FBK,KZG,KZW	0 204 131 706 ^A					
FT 350 2.3i LPG	04.06-09.11	107/147	FBK,KZS,KZW	0 204 131 705 ^A					
			FBK,KZG,KZW	0 204 131 706 ^A					
FT 350 3.2 TDCi	04.06-09.11	107/147	FBK,KZS,KZW	0 204 131 705 ^A					
			FBK,KZW,ORA	0 204 131 704 ^A					
			FBK,KZW,RSA	0 204 131 710 ^A					















		S										
FT 350 2.4 TDCi		07.06-09.11	74-74					FBK,KZB,KZE	0 204 131 703 ^A			
								FBK,KZG,KZW	0 204 131 706 ^A			
								FBK,KZS,KZW	0 204 131 705 ^A			
								FBK,KZW,ORA	0 204 131 704 ^A			
								FBK,KZW,RSA	0 204 131 710 ^A			
								85-85	FBK,KZB,KZE	0 204 131 703 ^A		
									FBK,KZG,KZW	0 204 131 706 ^A		
									FBK,KZS,KZW	0 204 131 705 ^A		
									FBK,KZW,ORA	0 204 131 704 ^A		
									FBK,KZW,RSA	0 204 131 710 ^A		
FT 350 2.4 TDCi FT 350 2.4 TDCi 4x4		07.06-09.11	103					FBK,KZB,KZE	0 204 131 703 ^A			
								FBK,KZG,KZW	0 204 131 706 ^A			
FT 260 2.2 TDCi		04.06-08.07	96-96						0 265 231 704 ^B			
									0 265 233 341 ^F			
									0 265 234 354 ^T			
								04.06-10.07	63/81		TW	0 265 234 354 ^T
								04.06-09.11	63/81			0 265 231 704 ^B
												0 265 233 341 ^F
								08.07-09.11	63/81		TW	0 265 235 441 ^T
								10.07-10.07	103		TW	0 265 234 354 ^T
								10.07-09.11	103			0 265 231 704 ^B
												0 265 233 341 ^F
											TW	0 265 235 441 ^T
								10.08-09.11	85			0 265 231 704 ^B
												0 265 233 341 ^F
												0 265 235 441 ^T
								FT 280 2.2 TDCi		04.06-08.07	96-96	
	0 265 233 341 ^F											
	0 265 234 354 ^T											
04.06-10.07	63/81		TW	0 265 234 354 ^T								
04.06-09.11	63/81			0 265 231 704 ^B								
				0 265 233 341 ^F								
08.07-09.11	63/81		TW	0 265 235 441 ^T								
10.07-10.07	103		TW	0 265 234 354 ^T								
10.07-09.11	103			0 265 231 704 ^B								
				0 265 233 341 ^F								
			TW	0 265 235 441 ^T								
10.08-09.11	85			0 265 231 704 ^B								
				0 265 233 341 ^F								
				0 265 235 441 ^T								
FT 300 2.2 TDCi		04.06-08.07	96						0 265 231 704 ^B			
									0 265 233 341 ^F			
									0 265 234 354 ^T			
								04.06-10.07	63		TW	0 265 234 354 ^T
									81		TW	0 265 234 354 ^T
								04.06-06.10	81			0 265 231 704 ^B
												0 265 233 341 ^F
								04.06-09.11	63			0 265 231 704 ^B
												0 265 233 341 ^F
								08.07-06.10	81		TW	0 265 235 441 ^T
								08.07-09.11	63		TW	0 265 235 441 ^T
								10.07-10.07	103		TW	0 265 234 354 ^T
								10.07-09.11	103			0 265 231 704 ^B
				0 265 233 341 ^F								
			TW	0 265 235 441 ^T								
10.08-09.11	85			0 265 231 704 ^B								
				0 265 233 341 ^F								
				0 265 235 441 ^T								
FT 300 2.3i		04.06-09.11	107						0 265 231 705 ^B			
									0 265 233 342 ^F			



			S									
◀ FORD Transit [06]												
FT 300 2.4 TDCi	07.06-10.07	74-74						0 265 234 355 ^T				
		85					0 265 234 355 ^T					
	07.06-09.11	74-74						0 265 231 705 ^B				
		85						0 265 233 342 ^F				
	11.07-09.11	74-74						0 265 231 705 ^B				
		85						0 265 233 342 ^F				
	FT 330 2.2 TDCi	04.06-08.07	96						0 265 231 704 ^B			
								0 265 233 341 ^F				
								0 265 234 354 ^T				
		04.06-10.07	81					TW	0 265 234 354 ^T			
81								0 265 231 704 ^B				
08.07-06.10		81					TW	0 265 233 341 ^F				
								0 265 235 441 ^T				
10.07-10.07		103					TW	0 265 234 354 ^T				
10.07-09.11		103							0 265 231 704 ^B			
								0 265 233 341 ^F				
						TW	0 265 235 441 ^T					
10.08-09.11	85							0 265 231 704 ^B				
							0 265 233 341 ^F					
							0 265 235 441 ^T					
FT 330 2.3i CNG	04.06-09.11	100-107						0 265 231 705 ^B				
FT 330 2.3i	04.06-09.11	107						0 265 233 342 ^F				
FT 330 2.3i LPG	04.06-09.11	107						0 265 231 705 ^B				
FT 330 2.4 TDCi	07.06-10.07	74-74						0 265 233 342 ^F				
		85-85						0 265 234 355 ^T				
		103						0 265 234 355 ^T				
	07.06-09.11	74-74							0 265 231 705 ^B			
		85-85							0 265 233 342 ^F			
		103							0 265 231 705 ^B			
	11.07-09.11	74-74							0 265 233 342 ^F			
		85-85							0 265 231 705 ^B			
		103							0 265 233 342 ^F			
	FT 330 2.4 TDCi 4x4	09.07-09.11	103					0 265 235 438 ^T				
	FT 350 2.2 TDCi	04.06-08.07	96						0 265 231 912 ^B			
									0 265 231 704 ^B			
									0 265 233 341 ^F			
		04.06-10.07	81						TW	0 265 234 354 ^T		
			81							0 265 231 704 ^B		
08.07-06.10		81						TW	0 265 233 341 ^F			
									0 265 235 441 ^T			
10.07-10.07		103						TW	0 265 234 354 ^T			
10.07-09.11		103							0 265 231 704 ^B			
									0 265 233 341 ^F			
							TW	0 265 235 441 ^T				
10.08-09.11		85							0 265 231 704 ^B			
									0 265 233 341 ^F			
									0 265 235 441 ^T			
FT 350 2.3i CNG		04.06-09.11	100-107						0 265 231 705 ^B			
FT 350 2.3i	04.06-09.11	107						0 265 233 342 ^F				
FT 350 2.3i LPG	04.06-09.11	107						0 265 231 705 ^B				
FT 350 2.4 TDCi	07.06-10.07	74-74						0 265 233 342 ^F				
		85-85						0 265 234 355 ^T				
		103						0 265 234 355 ^T				
	07.06-09.11	74-74							0 265 231 705 ^B			
		85-85							0 265 233 342 ^F			
		103							0 265 231 705 ^B			



	S							
FT 350 2.4 TDCi	07.06-09.11	85-85				0 265 231 705 ^B		
						0 265 233 342 ^F		
		103				0 265 231 705 ^B		
						0 265 233 342 ^F		
	11.07-09.11	74-74				0 265 235 438 ^T		
						0 265 235 438 ^T		
			103			0 265 235 438 ^T		
FT 350 2.4 TDCi 4x4	09.07-09.11	103				0 265 231 912 ^B		
FT 350 3.2 TDCi	08.07-10.07	147				0 265 234 355 ^T		
						0 265 231 705 ^B		
	08.07-09.11	147				0 265 233 342 ^F		
	11.07-09.11	147				0 265 235 438 ^T		
FT 430 2.4 TDCi	07.06-10.07	74-74/85-85/103				0 265 234 355 ^T		
						0 265 231 705 ^B		
	07.06-09.11	74-74/85-85/ 103				0 265 233 342 ^F		
						0 265 235 438 ^T		
FT 460 2.4 TDCi	07.06-10.07	85/103/147				0 265 234 355 ^T		
FT 460 3.2 TDCi	07.06-09.11	85/103/ 147				0 265 231 705 ^B		
						0 265 233 342 ^F		
	11.07-09.11	85/103/147				0 265 235 438 ^T		
 FT 260 2.2 TDCi	04.06-08.07	96-96				0 265 005 690		
	04.06-10.07	63/81			TW	0 265 005 690		
	10.07-10.07	103			TW	0 265 005 690		
FT 280 2.2 TDCi	04.06-08.07	96-96				0 265 005 690		
	04.06-10.07	63/81			TW	0 265 005 690		
	10.07-10.07	103			TW	0 265 005 690		
FT 300 2.2 TDCi	04.06-08.07	96				0 265 005 690		
	10.07-10.07	103			TW	0 265 005 690		
FT 300 2.2 TDCi, 2.4 TDCi	04.06-10.07	63/74-74/81/85			TW	0 265 005 690		
FT 330 2.2 TDCi	04.06-08.07	96				0 265 005 690		
FT 330 2.2 TDCi	04.06-10.07	74-74/81/85-85			TW	0 265 005 690		
FT 330 2.4 TDCi	07.06-10.07	103			TW	0 265 005 690		
FT 350 2.2 TDCi	04.06-08.07	96				0 265 005 690		
FT 350 2.2 TDCi, 2.4 TDCi	04.06-10.07	74-74/81/85-85			TW	0 265 005 690		
FT 350 2.2 TDCi, 2.4 TDCi, 3.2 TDCi	07.06-10.07	103/147			TW	0 265 005 690		
FT 430 2.4 TDCi	07.06-10.07	74-74/85-85/103			TW	0 265 005 690		
FT 460 2.4 TDCi, 3.2 TDCi	07.06-10.07	85/103/147			TW	0 265 005 690		
Transit [12]								
								
	FT 250 2.2 TDCi	09.11-12.13	74			0 204 123 716	25,4	
	FT 260 2.2 TDCi	09.11-12.13	74/92/103			0 204 123 716	25,4	
	FT 280 2.2 TDCi	09.11-12.13	74/92/103			0 204 123 716	25,4	
	FT 300 2.2 TDCi	09.11-12.13	74/92/103			0 204 123 716	25,4	
	FT 330 2.2 TDCi	09.11-12.13	74/92/103/114			0 204 123 716	25,4	
	FT 350 2.2 TDCi, 2.2 TDCi HDT	09.11-12.13	74/92/99/103/114			0 204 123 716	25,4	
	FT 370 2.2 TDCi	09.11-12.13	74/92/114			0 204 123 716	25,4	
	FT 430 2.2 TDCi, 2.2 TDCi HDT	09.11-12.13	74/92/99/114			0 204 123 716	25,4	
	FT 460 2.2 TDCi	09.11-12.13	92/114			0 204 123 716	25,4	
		FT 250 2.2 TDCi	09.11-12.13	74			0 204 125 857	
FT 260 2.2 TDCi		09.11-12.13	74/92/103			0 204 125 857		0 204 127 528
FT 280 2.2 TDCi		09.11-12.13	74/92/103			0 204 125 857		0 204 127 528
FT 300 2.2 TDCi		09.11-12.13	74/92/103			0 204 125 857		0 204 127 528
	FT 330 2.2 TDCi	09.11-12.13	92			0 265 231 912 ^B		
	FT 350 2.2 TDCi	09.11-12.13	92			0 265 231 912 ^B		



		S							
◀ FORD									
Transit [14]									
	FT 290 2.2 TDCi HDT		09.11-12.13	99			0 204 123 716	25,4	
Transit [92]									
	2.0 i LWB 100-190, i SWB 80-150, LWB 100-190, SWB 80-150	ABO	08.91-07.94	65-66/72		JBH	F 026 003 136	23,8	
	2.5 DI LWB 100 L, DI LWB 100-190, DI SWB 80-120, DI SWB 80-150, DI Turbo LWB 100-190, DI Turbo LWB 150-190 L, DI Turbo SWB 80-150, DI Turbo SWB 150 S	ABO	08.91-07.94	51-52/59/63/74		JBH	F 026 003 136	23,8	
	2.9 V6 LWB 100 L-190	ABO	08.91-07.94	104		JBH	F 026 003 136	23,8	
	2.0 i LWB 100-190, i SWB 80-150, LWB 100-190, SWB 80-150	ABO	08.91-07.94	65-66/72			0 204 125 068		
	2.5 DI LWB 100 L, DI LWB 100-190, DI SWB 80-120, DI SWB 80-150, DI Turbo LWB 100-190, DI Turbo LWB 150-190 L, DI Turbo SWB 80-150, DI Turbo SWB 150 S	ABO	08.91-07.94	51-52/59/63/74			0 204 125 068		
	2.9 V6 LWB 100 L-190	ABO	08.91-07.94	104			0 204 125 068		
	2.0 i LWB 100-190, i SWB 80-150, LWB 100-190, SWB 80-150		08.91-07.94	65-66/72		BRV,TW	0 204 131 356^A		
	2.0 i LWB 100-190		08.91-07.94	65-66/72		BRD,TW	0 204 131 369^A		
	2.0 LWB 100-190					BRV,TW	0 204 131 366^A		
	2.0 i SWB 80-150		08.91-07.94	65-66/72		BRD,TW	0 204 131 359^A		
	2.0 SWB 80-150					BRV,TW	0 204 131 354^A		
	2.5 DI LWB 100 L		08.91-07.94	52		BRD,BUS	0 204 131 360^A		
						BRV,BUS	0 204 031 298^A		
	2.5 DI LWB 100-190, DI SWB 80-150, DI Turbo LWB 100-190, DI Turbo SWB 80-150		08.91-07.94	59/63		BRD,TW	0 204 131 360^A		
						BRV,TW	0 204 031 298^A		
	2.5 DI LWB 100-190		08.91-07.94	59/63		BRD,TW	0 204 131 680^A		
	2.5 DI Turbo LWB 100-190					BRV,TW	0 204 131 358^A		
	2.5 DI SWB 80-120		08.91-07.94	51-52		BRD	0 204 131 367^A		
				52		BRV	0 204 031 299^A		
						BRD	0 204 131 367^A		
						BRV	0 204 031 299^A		
	2.5 DI SWB 80-150		08.91-07.94	59/63		BRD,TW	0 204 131 367^A		
	2.5 DI Turbo SWB 80-150					BRV,TW	0 204 031 299^A		
	2.5 DI Turbo LWB 150-190 L		08.91-07.94	74		BRD,TW	0 204 131 360^A		
							0 204 131 680^A		
						BRV,TW	0 204 031 298^A		
							0 204 131 358^A		
	2.5 DI Turbo SWB 150 S		08.91-07.94	74		BRD	0 204 131 360^A		
						BRV	0 204 031 298^A		
	2.9 V6 LWB 100 L-190		08.91-07.94	104		BRD,TW	0 204 131 360^A		
							0 204 131 680^A		
						BRV,TW	0 204 031 298^A		
							0 204 131 358^A		





Transit [95]



	FT 080 2.0i, 2.5 D, 2.5 DI, 2.5 TD, 2.5 TDI	ABO 08.94-03.97	51/55/56/63/74/84	JBH	F 026 003 136	23,8
		04.97-08.00	51/55/56/63/74/84	JBH	F 026 003 354	23,8
		ABS 04.97-08.00	51/55/56/63/74/84/85		0 204 123 355	23,81
	FT 080 2.5 TDI	ABO 03.99-08.00	85	JBH	F 026 003 354	23,8
	FT 100 2.0i, 2.5 D, 2.5 DI, 2.5 TD, 2.5 TDI	ABO 08.94-03.97	51/56/63/74/84	JBH	F 026 003 136	23,8
		04.97-08.00	51/56/63/74/84	JBH	F 026 003 354	23,8
		ABS 04.97-08.00	51/56/63/74/84/85		0 204 123 355	23,81
	FT 100 2.5 TDI	ABO 03.99-08.00	85	JBH	F 026 003 354	23,8
	FT 120 2.0i, 2.5 D, 2.5 DI, 2.5 TD	ABO 08.94-03.97	51/56/63/74/84	JBH	F 026 003 136	23,8
		04.97-08.00	51/56/63/74/84	JBH	F 026 003 354	23,8
	FT 120 2.0i, 2.5 D, 2.5 DI, 2.5 TD, 2.5 TDI	ABS 04.97-08.00	51/56/63/74/84/85		0 204 123 355	23,81
		ABO 03.99-08.00	85	JBH	F 026 003 354	23,8
	FT 150 2.0i, 2.5 DI, 2.5 TD, 2.5 TDI	ABO 08.94-03.97	56/63/74/84	JBH	F 026 003 136	23,8
		04.97-08.00	56/63/74/84	JBH	F 026 003 354	23,8
	FT 150 2.5 TDI	ABS 04.97-08.00	56/63/74/84/85		0 204 123 355	23,81
		ABO 03.99-08.00	85	JBH	F 026 003 354	23,8
	FT 190 2.0i, 2.5 DI, 2.5 TD, 2.5 TDI	ABO 08.94-03.97	56/63/74/84	JBH	F 026 003 136	23,8
		04.97-08.00	56/63/74/84	JBH	F 026 003 354	23,8
		ABS 04.97-08.00	56/63/74/84/85		0 204 123 355	23,81
	FT 190 2.5 TDI	ABO 03.99-08.00	85	JBH	F 026 003 354	23,8

	FT 080 2.0i, 2.5 D, 2.5 DI, 2.5 TD, 2.5 TDI	04.97-08.00	51/55/56/63/74/84/85	LLE	0 204 125 531	
		ABO 08.94-03.97	51/55/56/63/74/84	LLE	0 204 125 101	
					0 204 125 127	
	FT 100 2.0i, 2.5 D, 2.5 DI, 2.5 TD, 2.5 TDI	04.97-08.00	51/56/63/74/84/85	LLE	0 204 125 531	
		ABO 08.94-03.97	51/56/63/74/84	LLE	0 204 125 101	
					0 204 125 127	
	FT 120 2.0i, 2.5 D, 2.5 DI, 2.5 TD	ABO 08.94-03.97	51/56/63/74/84	LLE	0 204 125 101	
					0 204 125 127	
	FT 120 2.0i, 2.5 D, 2.5 DI, 2.5 TD, 2.5 TDI	04.97-08.00	51/56/63/74/84/85	LLE	0 204 125 531	
	FT 150 2.0i	04.97-08.00	56/63/74/84/85	LLE	0 204 125 531	
	FT 150 2.5 DI, 2.5 TD, 2.5 TDI	ABO 08.94-03.97	56/63/74/84	LLE	0 204 125 101	
					0 204 125 127	
	FT 190 2.0i, 2.5 DI, 2.5 TD, 2.5 TDI	04.97-08.00	56/63/74/84/85	LLE	0 204 125 531	
		ABO 08.94-03.97	56/63/74/84	LLE	0 204 125 101	
					0 204 125 127	

	FT 080 2.0i	08.94-07.00	84	BRD	0 204 131 359 ^A	
				BRV	0 204 131 354 ^A	
	FT 080 2.5 D, 2.5 DI, 2.5 TD, 2.5 TDI	08.94-08.00	51/55/56/63/74	BRD,TW	0 204 131 360 ^A	
					0 204 131 367 ^A	
				BRV,TW	0 204 031 298 ^A	
					0 204 031 299 ^A	
	FT 080 2.5 TDI	03.99-08.00	85	BRD,TW	0 204 131 360 ^A	
					0 204 131 367 ^A	
				BRV,TW	0 204 031 298 ^A	
					0 204 031 299 ^A	
	FT 100 2.0i	08.94-07.00	84	BRD,TW	0 204 131 359 ^A	
				BRV,TW	0 204 131 354 ^A	
					0 204 131 356 ^A	
					0 204 131 368 ^A	
	FT 100 2.5 D	08.94-08.00	51/56/63/74	BRD,TW	0 204 131 360 ^A	
	FT 100 2.5 DI				0 204 131 367 ^A	
	FT 100 2.5 TD			BRV,TW	0 204 031 298 ^A	
	FT 100 2.5 TDI				0 204 031 299 ^A	
	FT 100 2.5 TDI	03.99-08.00	85	BRD,TW	0 204 131 360 ^A	
					0 204 131 367 ^A	





Vehicle Model	Year Range	Power	Configuration	Part Type	Part Number
◀ FORD Transit [95]					
FT 100 2.5 TDI	03.99-08.00	85		BRV,TW	0 204 031 298 ^A 0 204 031 299 ^A
FT 120 2.0i	08.94-07.00	84		BRD BRD,TW BRV,TW	0 204 131 359 ^A 0 204 131 359 ^A 0 204 131 354 ^A 0 204 131 356 ^A
FT 120 2.5 D	08.94-08.00	51/56/63/		BRD,TW	0 204 131 360 ^A
FT 120 2.5 DI		74			0 204 131 367 ^A
FT 120 2.5 TD				BRV,TW	0 204 031 298 ^A 0 204 031 299 ^A
FT 120 2.5 TDI	03.99-08.00	85		BRD,TW BRV,TW	0 204 131 360 ^A 0 204 131 367 ^A 0 204 031 298 ^A 0 204 031 299 ^A
FT 150 2.0i	08.94-07.00	84		BRD,TW BRV,TW	0 204 131 369 ^A 0 204 131 356 ^A 0 204 131 366 ^A 0 204 131 368 ^A
FT 150 2.5 DI	08.94-08.00	56/63/74		BRD,TW	0 204 131 360 ^A
FT 150 2.5 TD					0 204 131 367 ^A
FT 150 2.5 TDI				BRV,TW	0 204 131 680 ^A 0 204 031 298 ^A 0 204 031 299 ^A
FT 150 2.5 TDI	03.99-08.00	85		BRD,TW BRV,TW	0 204 131 360 ^A 0 204 131 367 ^A 0 204 131 680 ^A 0 204 031 298 ^A 0 204 031 299 ^A
FT 190 2.0i	08.94-07.00	84		BRD BRV	0 204 131 369 ^A 0 204 131 366 ^A
FT 190 2.5 DI	08.94-08.00	56/63/74		BRD,TW	0 204 131 360 ^A
FT 190 2.5 TD					0 204 131 367 ^A
FT 190 2.5 TDI				BRV,TW	0 204 131 680 ^A 0 204 031 298 ^A 0 204 031 299 ^A 0 204 131 358 ^A
FT 190 2.5 TDI	03.99-08.00	85		BRD,TW BRV,TW	0 204 131 360 ^A 0 204 131 367 ^A 0 204 131 680 ^A 0 204 031 298 ^A 0 204 031 299 ^A 0 204 131 358 ^A
FT 080 2.0i, 2.5 D, 2.5 DI, 2.5 TD, 2.5 TDI	11.97-08.00	51/55/56/63/74/84/85			0 265 220 468 ^J
FT 080 2.5 DI	ABS, 11.97-08.00	56		AK	0 265 216 625 ^H
FT 100 2.0i, 2.5 D, 2.5 DI, 2.5 TD, 2.5 TDI	11.97-08.00	51/56/63/74/84/85			0 265 220 468 ^J
FT 100 2.5 DI	ABS, 11.97-08.00	56		AK	0 265 216 625 ^H
FT 120 2.0i, 2.5 D, 2.5 DI, 2.5 TD, 2.5 TDI	11.97-08.00	51/56/63/74/84/85			0 265 220 468 ^J
FT 120 2.5 DI	ABS, 11.97-08.00	56		AK	0 265 216 625 ^H
FT 150 2.0i, 2.5 DI, 2.5 TD, 2.5 TDI	11.97-08.00	56/63/74/84/85			0 265 220 468 ^J
FT 150 2.5 DI	ABS, 11.97-08.00	56		AK	0 265 216 625 ^H
FT 190 2.0i, 2.5 DI, 2.5 TD, 2.5 TDI	11.97-08.00	56/63/74/84/85			0 265 220 468 ^J
FT 190 2.5 DI	ABS, 11.97-08.00	56		AK	0 265 216 625 ^H



	FT 080 2.0i, 2.5 D, 2.5 DI, 2.5 TD, 2.5 TDI		11.97-08.00	51/55/56/63/74/84/85			1 273 004 260 ^J	
	FT 080 2.5 DI	ABS, OAS	11.97-08.00	56	AK		1 273 004 340 ^H	
	FT 100 2.0i, 2.5 D, 2.5 DI, 2.5 TD, 2.5 TDI		11.97-08.00	51/56/63/74/84/85			1 273 004 260 ^J	
	FT 100 2.5 DI	ABS, OAS	11.97-08.00	56	AK		1 273 004 340 ^H	
	FT 120 2.0i, 2.5 D, 2.5 DI, 2.5 TD, 2.5 TDI		11.97-08.00	51/56/63/74/84/85			1 273 004 260 ^J	
	FT 120 2.5 DI	ABS, OAS	11.97-08.00	56	AK		1 273 004 340 ^H	
	FT 150 2.0i, 2.5 DI, 2.5 TD, 2.5 TDI		11.97-08.00	56/63/74/84/85			1 273 004 260 ^J	
	FT 150 2.5 DI	ABS, OAS	11.97-08.00	56	AK		1 273 004 340 ^H	
	FT 190 2.0i, 2.5 DI, 2.5 TD, 2.5 TDI		11.97-08.00	56/63/74/84/85			1 273 004 260 ^J	
	FT 190 2.5 DI	ABS, OAS	11.97-08.00	56	AK		1 273 004 340 ^H	

GAZ

GAZelle [2705,3221,3302]

	2.1 TD		07.10-03.13	65				0 204 255 397
	2.4		07.05-03.13	112				0 204 255 397
	2.5 i, i 4x4		01.08-03.13	98				0 204 255 397
	2.8 TD		08.10-03.13	102,7				0 204 255 397
	2.9 i, i 16V		04.99-03.13	85				0 204 255 397
	2.1 TD		09.97-03.13	70/81			0 265 215 525 ^B	
	2.3		01.97-03.13	73,5/80,9			0 265 215 525 ^B	

GAZelle [3705,3221,3302]

	2.8 TD		08.10-03.13	88,3				0 204 255 397

Sobol [2217,2310,2752]

	2.1 TD		07.10→	65				0 204 255 397
	2.4 L DOHC		01.94-04.13	112				0 204 255 397
	2.5 i 4x4		01.08→	98				0 204 255 397
	2.8 TD		08.10→	88,3/102,7				0 204 255 397
	2.1 TD		09.97→	81			0 265 215 525 ^B	
	2.3		09.97-04.13	80,9			0 265 215 525 ^B	

HOLDEN

Astra [G]

	1.8 i	MFD	09.00-08.09	92	JBH		0 986 481 028	23,81
		OFD	09.00-08.09	92	JBH		0 986 480 699	23,8
	1.8 i		09.00-08.09	92	LLE		0 986 486 068	



◀ HOLDEN Astra [G]

	1.8 i	09.00-08.09	92	Fg.-Nr. →12999999, →15999999, →16999999, →18999999, →1B999999 Fg.-Nr. 22000001→, 25000001→, 26000001→, 28000001→ Fg.-Nr. 22000001→32035797, 25000001→35033917, →38004448 Fg.-Nr. 32035798→, 35033918→, 38004449→	0 265 202 492 ^T 0 265 220 585 ^B 0 265 220 637 ^F 0 265 202 492 ^T 0 265 202 509 ^T		
	1.8 i	09.00-08.09	92		0 265 005 262		
	1.8 i	09.00-08.09	92		0 265 005 435		
	1.8 i	09.00-08.09	92		0 265 005 303		

Barina [XC]

	1.8 i 16V	09.01-03.03	92	Fg.-Nr. →34999999	AI5	F 026 A01 733		
		03.03-09.04	92	Fg.-Nr. 44000001→	AI0	F 026 A06 502		
		04.03-09.04	92	Fg.-Nr. 44000001→	AI5	0 204 123 659	22,2	

Jackaroo [U8]

	3.0 DT 4x4	04.00-01.04	118			F 01G 09C 0BK		
	3.0 DT 4x4	04.00-12.02	118			F 026 A06 925		

Rodeo [RA]

	2.4	03.03-12.06	94			F 026 A06 918		
	2.4	01.07-06.08	94			F 026 A06 906		

Rodeo 4x4 [TF]

	3.2	01.01-02.03	140			F 01G 09C 0BK		
--	-----	-------------	-----	--	--	----------------------	--	--

HONDA

Accord

	2.4 i	04.08→	129-133			F 026 A09 662		
	3.0 i	09.02-11.06	177			F 01G 09C 192		F 01G 09C 16K ⁶
	3.0 i	09.02-11.06	177			0 986 486 603	19	

		S								
Accord Aerodeck [CB/CC/CD/CE]										
	2.2 i16V	01.91-06.94	108-110		JBH		0 986 480 701	23,8		
Accord [CF]										
	2.3	09.97-08.99	101				F 026 A01 909			
Accord [CG/CH/CL]										
	1.6 iLS	10.98-08.99	79				F 026 A01 909			
	1.6 iLS	10.98-02.03	79				0 265 216 650 ^B			
Accord [CL/CN/CM]										
	2.0	02.03-12.06	114		LLE		F 01G 09C 192		F 01G 09C 16K ⁶	
		02.03-06.08	114	Fg.-Nr. →3C205104	RLE		F 01G 09C 19A		F 01G 09C 179 ⁶	
				Fg.-Nr. 3C205105→ 5C207038	RLE		F 01G 09C 19B		F 01G 09C 179 ⁶	
				Fg.-Nr. 5C207039→	RLE		F 01G 09C 19C		F 01G 09C 179 ⁶	
			01.06-06.08	114			F 01G 09C 192		F 01G 09C 16K ⁶	
		01.07-06.08	114		LLE		F 01G 09C 19D		F 01G 09C 179 ⁶	
	2.2 CTDI	01.04-06.08	103		LLE		F 01G 09C 192		F 01G 09C 16K ⁶	
					Fg.-Nr. →5C209606	RLE		F 01G 09C 190		F 01G 09C 16K ⁶
				Fg.-Nr. 5C209607→	RLE		F 01G 09C 191		F 01G 09C 16K ⁶	
	2.4	02.03-12.05	140	Fg.-Nr. →3C204214			F 01G 09C 18B		F 01G 09C 16J ⁶	
				Fg.-Nr. 3C204215→5C207713			F 01G 09C 18C		F 01G 09C 16K ⁶	
				Fg.-Nr. 5C207714→5C216882			F 01G 09C 18D		F 01G 09C 16K ⁶	
				Fg.-Nr. 5C216883→			F 01G 09C 18E			
		01.06-06.08	140				F 01G 09C 192		F 01G 09C 16K ⁶	
	2.2 CTDI	01.04-06.08	103		TW		F 01G 061 0JP			
							F 01G 061 01M			
	2.4	02.03-12.04	140		LLE		F 01G 09B 1WM			
			01.05-12.05	140		LLE		F 01G 061 0JD		
	2.0	02.03-06.08	114	Fg.-Nr. 3C*00001→3C*99999, LLE 4C*00001→			0 986 486 603	19		
			01.06-06.08	114		LLE		0 986 486 603	19	
	2.4	02.03-06.08	140	Fg.-Nr. 3C*00001→3C*99999, LLE 4C*00001→			0 986 486 603	19		
Accord [CM]										
	2.4 VTI-E	09.02-08.05	118	Fg.-Nr. →3C404773			F 01G 09C 19A		F 01G 09C 178 ⁶	
					Fg.-Nr. 3C404774→			F 01G 09C 19B		F 01G 09C 179 ⁶
			09.05-08.07	124				F 01G 09C 192		F 01G 09C 16K ⁶
	2.4 VTI-E	09.02-08.05	118				F 01G 061 0HZ			



		S							
◀ HONDA Accord [CM]									
	2.4 VTE		09.02-08.07	118/124			0986 486 603	19	
Accord Coupé [CB/CC/CD/CE]									
	2.0 i 16V		09.93-12.97	100	LLE		F 026 A06 949		
	2.2 i 16V		09.93-06.98	110	LLE		F 026 A06 949		
Accord Coupé [CG]									
	2.0 i 16V		12.97-12.98	110	LLE		F 026 A01 909		
Accord Hatchback [CG/CH/CL]									
	1.8 i		10.98-02.03	100	JBH		0986 480 853		
	2.0 i		01.99-08.00	108	JBH,LLE		0986 480 853		
	2.0 TDi		01.99-10.00	77	JBH		0986 480 853		
	1.6 i		10.98-08.99	85			F 026 A01 909		
	1.8 i		10.98-12.99	100	LLE		F 026 A01 909		
	2.0 i		01.99-08.99	108			F 026 A01 909		
	1.6 i		10.98-02.03	85			0 265 216 650 ^B		
	1.8 i		10.98-02.03	100			0 265 216 650 ^B		
	2.0 i, TDi		01.99-08.02	77/108			0 265 216 650 ^B		
	2.3 i		11.00-08.02	113			0 265 216 650 ^B		
Accord Sedan [CC]									
	1.8 i 16V	ABO	09.93-09.95	85			0986 480 957	23,8	
	2.0 i 16V	ABO	03.93-09.95	85/96			0986 480 957	23,8	
	1.8 i 16V		09.93-09.95	85	LLE		0986 486 044	15,9	
	2.0 i 16V		03.93-09.95	85/96	LLE		0986 486 044	15,9	
	2.3 i 16V		03.93-09.95	116	LLE		0986 486 044	15,9	
	1.8 i 16V		09.95-09.95	85			0 265 216 049 ^H		
	2.0 i 16V		09.95-09.95	85/96			0 265 216 049 ^H		
	2.3 i 16V		09.95-09.95	116			0 265 216 049 ^H		
	1.8 i 16V		09.95-09.95	85			1 267 000 831 ^H		
	2.0 i 16V		09.95-09.95	85/96			1 267 000 831 ^H		
	2.3 i 16V		09.95-09.95	116			1 267 000 831 ^H		
Accord Sedan [CE/CF]									
	1.8 i 16V		09.95-10.98	85	LLE		0986 486 044	15,9	
	2.0 D Turbo, i 16V		09.95-10.98	77/96	LLE		0986 486 044	15,9	
	2.2 i 16V		09.95-10.98	110	LLE		0986 486 044	15,9	
	1.8 i 16V		09.95-10.98	85			0986 486 524	19	
	2.0 i 16V		09.95-10.98	96			0986 486 524	19	
	2.2 i 16V		09.95-10.98	110			0986 486 524	19	











































		S							
	1.8 i 16V	09.95-10.98	85					0 265 216 049 ^H	
	2.0 D Turbo, i 16V	09.95-10.98	77/96					0 265 216 049 ^H	
	2.2 i 16V	09.95-10.98	110					0 265 216 049 ^H	
	1.8 i 16V	09.95-10.98	85					1 267 000 831 ^H	
	2.0 D Turbo, i 16V	09.95-10.98	77/96					1 267 000 831 ^H	
	2.2 i 16V	09.95-10.98	110					1 267 000 831 ^H	
Accord Sedan [CG/CH/CL]									
	1.8 i	10.98-02.03	100			JBH		0 986 480 853	
	2.0 i, TDi	10.98-02.03	77/108			JBH		0 986 480 853	
	2.2 i Typ R	01.99-02.03	156			JBH		0 986 480 853	
	1.6 i	10.98-12.99	85			LLE		F 026 A01 909	
	1.8 i	10.98-12.99	100			LLE		F 026 A01 909	
	2.0 i	10.98-12.99	108			LLE		F 026 A01 909	
	2.2 i Typ R	01.99-12.99	156			LLE		F 026 A01 909	
	1.6 i	10.98-02.03	85					0 265 216 650 ^B	
	1.8 i	10.98-02.03	100					0 265 216 650 ^B	
	2.0 i, TDi	10.98-02.03	77/108					0 265 216 650 ^B	
	2.2 i Typ R	01.99-02.03	156					0 265 216 650 ^B	
Accord Tourer [CL/CN/CM]									
	2.0	02.03-12.04	114	Fg.-Nr. →3C200615	RLE		F 01G 09C 19A	F 01G 09C 178 ⁶	
				Fg.-Nr. 3C200616→	RLE		F 01G 09C 19B	F 01G 09C 179 ⁶	
				5C201365					
		02.03-08.08	114		LLE		F 01G 09C 192	F 01G 09C 16K ⁶	
		01.05-12.05	114	Fg.-Nr. 5C201366→	RLE		F 01G 09C 19C	F 01G 09C 179 ⁶	
		01.06-08.08	114				F 01G 09C 192	F 01G 09C 16K ⁶	
	2.2 CTDI	01.04-08.08	103		LLE		F 01G 09C 192	F 01G 09C 16K ⁶	
				Fg.-Nr. →5C203089	RLE		F 01G 09C 190	F 01G 09C 16K ⁶	
				Fg.-Nr. 5C203090→	RLE		F 01G 09C 191	F 01G 09C 16K ⁶	
	2.4	02.03-12.05	140	Fg.-Nr. →3C200254			F 01G 09C 18B	F 01G 09C 16J ⁶	
				Fg.-Nr. 3C200255→5C200495			F 01G 09C 18C	F 01G 09C 16K ⁶	
				Fg.-Nr. 5C200496→5C200885			F 01G 09C 18D	F 01G 09C 16K ⁶	
				Fg.-Nr. 5C200886→			F 01G 09C 18E		
		01.06-08.08	140				F 01G 09C 192	F 01G 09C 16K ⁶	
	2.2 CTDI	01.04-12.04	103		LLE		F 01G 061 01M		
	2.4	02.03-12.04	140		LLE		F 01G 09B 1WM		
		01.05-12.05	140		LLE		F 01G 061 0JD		
	2.0	02.03-08.08	114	Fg.-Nr. 3C*00001→3C*99999, LLE			0 986 486 603	19	
				4C*00001→					
		01.06-08.08	114		LLE		0 986 486 603	19	
	2.4	02.03-08.08	140	Fg.-Nr. 3C*00001→3C*99999, LLE			0 986 486 603	19	
				4C*00001→					
City									
	1.3 i 16V	01.98-10.03	66				F 026 A01 731		























		S							
◀ HONDA									
City [GM]									
	1.4	01.09-12.10	73					0986 486 602	19,05
City New [MN]									
	1.5 i 8V	10.03-12.06	57					F 026 A06 048	
City Sedan [FD]									
	1.8 i	09.05-08.09	103					0986 486 602	19,05
Civic									
	1.5 i	09.95-08.97	66			JBH		0986 480 864	
	1.5 i	09.95-08.00	66					0986 486 555	19
	2.0 i	05.03-12.04	116					0986 486 604	19
Civic Aerodeck [MB/MC]									
	1.4 i 16V	03.98-02.01	55/66			LLE		0986 486 142	15,87
	1.5 i 16V	03.98-02.01	84			LLE		0986 486 142	15,87
	1.6 i 16V	03.98-12.98	85			LLE		0986 486 142	15,87
		03.99-12.00	93			LLE		0986 486 142	15,87
		03.99-02.01	85			LLE		0986 486 142	15,87
	1.8 i 16V	03.98-02.01	124			LLE		0986 486 142	15,87
	1.4 i 16V	03.98-02.01	55/66			LLE		0986 486 555	19
	1.5 i 16V	03.98-02.01	84			LLE		0986 486 555	19
	1.6 i 16V	03.98-12.98	85			LLE		0986 486 555	19
		03.99-12.00	93			LLE		0986 486 555	19
		03.99-02.01	85			LLE		0986 486 555	19
	1.8 i 16V	03.98-02.01	124			LLE		0986 486 555	19
	1.4 i 16V	01.99-02.01	55/66					0 265 216 650^B	
	1.5 i 16V	01.99-02.01	84					0 265 216 650^B	
	1.6 i 16V	03.99-02.01	85/93					0 265 216 650^B	
	1.8 i 16V	01.99-02.01	124					0 265 216 650^B	
	2.0 D Turbo	04.98-12.99	77			LLE		0 265 216 520^B	
		01.00-02.01	77			LLE		0 265 216 685^B	
Civic Coupé									
	1.6 i 16V	01.96-08.00	81/118			LLE		0986 486 555	19
	1.7 i, iVTEC	05.01-12.05	88/92					0986 486 604	19
	1.7 i	05.01-12.05	88/92			LLE		F 01G 09D 08H^B	
	1.7 i VTEC								



























		S							
Civic Coupé [EJ]									
									
	1.6	ABO	09.95-12.96	59		GS,JBH	0 986 480 864		
	1.6		09.95-08.00	59/92		LLE	0 986 486 555	19	
Civic CRX [EG/EH]									
									
	1.6 i 16V	ABS	03.92-12.98	92/118			F 026 A01 678		
	1.6 i 16V		03.92-12.98	92/118		LLE	0 986 486 142	15,87	
	1.6 i 16V		03.92-12.98	92/118		LLE	0 986 486 555	19	
Civic Fastback [MA]									
									
	1.4 i 16V		09.94-01.97	66		LLE	0 986 486 142	15,87	
	1.5 i 16V		09.94-01.97	66		LLE	0 986 486 142	15,87	
	1.4 i 16V		09.94-01.97	66		LLE	0 986 486 555	19	
	1.5 i 16V		09.94-01.97	66		LLE	0 986 486 555	19	
Civic Fastback [MB/MC]									
									
	1.4 i 16V		03.97-02.01	55/66			0 986 486 142	15,87	
	1.5 i 16V		03.97-02.01	84			0 986 486 142	15,87	
	1.6 i 16V		09.94-01.97	83		LLE	0 986 486 142	15,87	
	1.6 i 16V			93		LLE	0 986 486 142	15,87	
	1.6 i 16V		03.97-02.01	85			0 986 486 142	15,87	
	1.6 i 16V		01.99-12.00	93			0 986 486 142	15,87	
	1.4 i 16V		03.97-02.01	55/66			0 986 486 555	19	
	1.5 i 16V		03.97-02.01	84			0 986 486 555	19	
	1.6 i 16V		09.94-01.97	83		LLE	0 986 486 555	19	
	1.6 i 16V			93		LLE	0 986 486 555	19	
	1.6 i 16V		03.97-02.01	85			0 986 486 555	19	
	1.6 i 16V		01.99-12.00	93			0 986 486 555	19	
	1.8 i 16V		03.97-02.01	124			0 986 486 555	19	
	1.4 i 16V		03.97-02.01	55/66			0 265 216 650 ^B		
	1.5 i 16V		03.97-02.01	84			0 265 216 650 ^B		
	1.6 i 16V		03.97-02.01	85/93			0 265 216 650 ^B		
	1.8 i 16V		03.97-02.01	124			0 265 216 650 ^B		
Civic Hatchback [EG/EH]									
									
	1.3 16V		10.91-09.95	55			F 026 A05 891		
	1.5 i 16V		10.91-09.95	66			F 026 A05 891		
	1.6 i 16V		10.91-09.95	92			F 026 A05 891		
	1.6 i 16V			118			F 026 A01 678		



									
◀ HONDA Civic Hatchback [EG/EH]									
	1.3 16V	10.91-09.95	55			LLE	0 986 486 142	15,87	
	1.5 i 16V	10.91-09.95	66			LLE	0 986 486 142	15,87	
	1.6 i 16V	10.91-09.95	92/118			LLE	0 986 486 142	15,87	
	1.3 16V	10.91-09.95	55			LLE	0 986 486 555	19	
	1.5 i 16V	10.91-09.95	66			LLE	0 986 486 555	19	
	1.6 i 16V	10.91-09.95	92/118			LLE	0 986 486 555	19	
Civic Hatchback [EJ/EK]									
									
	1.5 i 16V	10.95-12.99	84			JBH	0 986 480 864		
	1.6 i 16V	10.95-12.99	84			JBH	0 986 480 864		
	1.4 i 16V	10.95-02.01	55				0 986 486 555	19	
			66			LLE	0 986 486 555	19	
	1.5 i 16V	10.95-02.01	84			LLE	0 986 486 555	19	
	1.6 i 16V	10.95-02.01	118			LLE	0 986 486 555	19	
Civic Hatchback [EU/EP]									
									
	1.4	02.01-12.05	55-66			JBH,LLE	0 986 481 003	23,81	
	1.6 i	02.01-12.05	81			JBH,LLE	0 986 481 003	23,81	
	2.0 Type R	09.01-12.05	147			JBH,LLE	0 986 481 003	23,81	
	1.4	02.01-12.05	55-66				0 986 486 604	19	
	1.6 i	02.01-12.05	81				0 986 486 604	19	
	2.0 Type R	09.01-12.05	147			RLE	0 986 486 603	19	
	2.0 VSA	01.04-12.05	118				0 986 486 603	19	
	1.4	02.01-12.05	55-66				F 01G 09D 099 ^T		
	1.6 i	02.01-12.05	81				F 01G 09D 099 ^T		
	1.7 CTDi	01.02-12.04	74				F 01G 09D 099 ^T		
		01.05-12.05	74				F 01G 09D 09A ^B		
	2.0 Type R	09.01-12.05	147				F 01G 09D 09A ^B		
Civic Hatchback [FK/FN]									
									
	1.4	01.06-10.08	61			MG6	0 986 486 602	19,05	
		10.08-12.11	73			GS	0 986 486 602	19,05	
	1.4 i-VTEC	09.11→	73			TW	0 986 486 602	19,05	
	1.8	09.05-12.11	103			GS	0 986 486 602	19,05	
	1.8 i-VTEC	09.11→	104			TW	0 986 486 602	19,05	
	2.0 Type R	01.07-12.11	148			TW	0 986 486 603	19	
	1.4	01.06-12.07	61				0 265 235 078 ^T		
		01.08-10.08	61				0 265 235 397 ^T		
		10.08-12.11	73			GS	0 265 238 008 ^T		
							0 265 238 018 ^T		
						HAG	0 265 238 010 ^T		
	1.8	09.05-08.06	103			AG	0 265 235 080 ^T		
						GS	0 265 235 082 ^T		
		09.05-08.08	103				0 265 235 278 ^T		
		09.06-08.08	103				0 265 235 395 ^T		
		09.08-12.11	103			AG	0 265 238 014 ^T		
						GS	0 265 238 012 ^T		
	2.0 Type R	01.07-12.08	148				0 265 235 282 ^T		
	01.09-12.11	148			TW	0 265 238 030 ^T			
2.2 CTDi	09.05-12.06	103				0 265 235 074 ^T			



		S							
2.2 CTDi		01.07-12.08	103				0 265 235 280 ^T		
							0 265 235 399 ^T		
		01.09-12.11	103				0 265 238 016 ^T		
Civic Sedan									
									
 1.5 i		10.00-12.05	81				0 986 486 604	19	
Civic Sedan [EG/EH]									
									
 1.5 i16V		10.91-09.95	66				F 026 A05 891		
1.6 i16V		10.91-09.95	92				F 026 A05 891		
			118		TW		F 026 A01 678		
1.6 i16V 4WD		10.91-09.95	88		TW		F 026 A01 678		
Civic Sedan [EJ/EK]									
									
 1.4 i16V		ABO 10.95-02.01	66		JBH		0 986 480 864		
 1.4 i16V		10.95-02.01	66		LLE		0 986 486 555	19	
1.5 i16V		10.95-02.01	84		LLE		0 986 486 555	19	
1.6 i16V		10.95-02.01	118		LLE		0 986 486 555	19	
Civic Sedan [ES]									
									
 1.4		02.01-12.02	66				0 986 486 604	19	
1.6		02.01-12.06	81				0 986 486 604	19	
 1.4		02.01-12.02	66				F 01G 09D 08H ^B		
1.6		02.01-08.01	81				F 01G 09D 08H ^B		
		09.01-12.06	81		TW		F 01G 09D 08H ^B		
							F 01G 09D 09H ^B		
Civic Sedan [FB]									
									
 1.6		09.11-08.13	92		TW		0 986 486 602	19,05	
1.8 i-VTEC		09.11→	104				0 986 486 602	19,05	
Civic Sedan [FD]									
									
 1.6		09.06-12.11	92				0 986 486 602	19,05	
1.8		09.05-12.11	103				0 986 486 602	19,05	
1.8 i									
Civic Sedan [FD6]									
									
 1.6 i VTEC		06.06-08.10	92				0 986 486 602	19,05	



		S							
◀ HONDA									
Civic Shuttle [EC/ED/EE]									
	1.6 i 16V 4WD					JBH	0986 480 696	23,8	
Civiv Sedan [EJ/EK]									
	1.4 i 16V	ABO	10.95-10.98	66		JBH	0986 480 864		
	1.4 i 16V		10.95-10.98	66			0986 486 555	19	
Concerto Hatchback									
	1.5 i 16V		08.89-03.95	66			0986 480 700	22,2	
	1.6 i 16V		08.89-03.95	82/90-96			0986 480 700	22,2	
Concerto Sedan									
	1.5 i 16V		08.89-03.95	66			0986 480 700	22,2	
	1.6 i 16V		08.89-03.95	82/90-96			0986 480 700	22,2	
CR-V									
	2.0 i 4x4	ABS	09.98-08.01	110			0986 AB8 520	23,81	
	2.0 i 16V 4WD	ABS	01.99→	97			0986 AB8 520	23,81	
	2.0 i 16V 4WD		10.95-01.99	96		RLE	F 026 A01 928		
	2.0 i 4x4, i 16V 4WD		10.95-08.01	96/110			0986 486 555	19	
	2.4 i 4WD		05.04-12.05	119			0986 486 603	19	
CR-V [RD]									
	2.0 i 16V 4WD	ABS	01.99-07.02	108			0986 AB8 520	23,81	
	2.0 i 4WD		07.02-09.06	110			0986 486 603	19	
	2.0 i 16V 4WD		01.98-07.02	94-96/108			0986 486 555	19	
CR-V [RE]									
	2.0 i 4WD		09.06-12.12	110		LLE	0 204 123 768		
						RLE	0 204 123 758		
	2.2 CTDi 4x4		01.07-12.09	103		LLE	0 204 123 757		
						RLE	0 204 123 758		
	2.2 i-DTEC 4x4		01.10-12.12	110		LLE	0 204 123 768		
						RLE	0 204 123 758		
	2.4 4x4		09.06-08.10	122			0 204 123 768		



		S								
	2.0i 4WD	09.06-08.09	110			LLE	0 204 125 887			
						RLE	0 204 125 888			
		09.09-12.12	110			LLE	0 204 702 754			
						RLE	0 204 702 755			
	2.0i-VTEC	10.12→	114			LLE	0 204 806 549			
	2.0i-VTEC 4WD					RLE	0 204 806 547			
	2.2CTDi 4x4	01.07-12.09	103			LLE	0 204 125 889			
						RLE	0 204 125 890			
	2.2i-DTEC 4x4	01.10-12.12	110			LLE	0 204 702 756			
						RLE	0 204 702 757			
2.4 4x4	09.06-08.09	122					0 204 125 887			
	09.09-08.10	122					0 204 702 754			
	2.0i 4WD	09.06-08.09	110			AG,GES	0 265 235 303 ^T			
						AG,GES	0 265 235 305 ^T			
						GES,GS	0 265 235 307 ^T			
						GES,GS	0 265 235 309 ^T			
	2.2CTDi 4x4	01.07-12.09	103			GES	0 265 235 311 ^T			
						GES	0 265 235 313 ^T			
	2.2i-DTEC 4x4	01.10-12.12	110				AG,GES	0 265 238 045 ^T		
							HOG	0 265 238 043 ^T		
	CR-Z [ZF]									
	1.5 Hybrid	03.10-02.14	84-99				0 986 486 602	19,05		
Fit										
	1.5i	09.02-10.07	81			LLE	F 026 A05 946			
	1.5i	09.02-10.07	81				F 026 A06 048			
FR-V [BE]										
	1.7i	01.05-12.06	92			RLE	F 026 A09 637			
	1.7i	01.05-12.06	92				0 986 486 604	19		
	2.0i	01.05-12.06	110				0 986 486 603	19		
	1.7i	01.05-12.06	92				0 265 231 604 ^B			
	2.0i	01.05-12.06	110	Fg.-Nr. 6S202028→			0 265 234 267 ^B			
	2.2CTDi	07.05-06.09	103	Fg.-Nr. 6S207731→			0 265 234 269 ^B			
		01.07-06.09	103				0 265 234 595 ^B			
HR-V [GH]										
	1.6i 16V	12.98-12.05	77			LLE	0 986 486 555	19		
	1.6i 16V VTEC 4WD	10.99-12.05	92			LLE	0 986 486 555	19		
	1.6i 16V 4WD	12.98-12.05	77				0 986 486 555	19		
						LLE	0 986 486 555	19		



		S							
◀ HONDA									
Integra Type R [DC]									
	1.8 i 16V	01.98-10.01	140				0986 486 555	19	
Jazz [GD]									
	1.2	03.02-12.08	55-57	Fg.-Nr. →2S210279	JBH		0986 480 881	20,6	
	1.2	01.03-12.06	55-57				F 026 A05 945		
		01.07-12.08	55-57				F 026 A05 946		
	1.4	03.02-12.06	61				F 026 A05 945		
		01.07-12.08	61				F 026 A05 946		
	1.2	03.02-12.08	55-57				F 026 A06 048		
	1.4	03.02-12.08	61				F 026 A06 048		
Jazz [GE/GG]									
	1.2	10.08→	66		RLE		F 026 A09 637		
	1.4	10.08→	73		RLE		F 026 A09 637		
	1.2	10.08→	66				0986 486 602	19,05	
	1.4	10.08-12.14	73				0986 486 602	19,05	
		10.08→	73		GS		0986 486 602	19,05	
Legend									
	3.5 i 24V	01.00-12.04	147-151	Fg.-Nr. →YC200891			F 01G 09D 0AF ^H		
Prelude [BB]									
	2.0 i 16V	10.96-12.99	98		LLE		0986 486 044	15,9	
	2.2 i 16V, i 16V 4WS	10.96-12.01	136/147		LLE		0986 486 044	15,9	
	2.3 i 16V	12.91-01.94	118				F 026 A01 875		
	2.0 i 16V	10.96-12.99	98		LLE		F 026 A06 949		
	2.2 i 16V	12.91-12.96	96				F 026 A06 949		
		01.94-12.96	142				F 026 A06 949		
	2.2 i 16V	10.96-08.01	136		LLE		F 026 A06 949		
	2.2 i 16V 4WS	10.96-12.01	147		LLE		F 026 A06 949		
Stream [RN]									
	1.7 i 16V	05.01-08.05	92				0986 486 604	19	
	2.0 i 16V	05.01-08.05	115		LLE		0986 486 603	19	



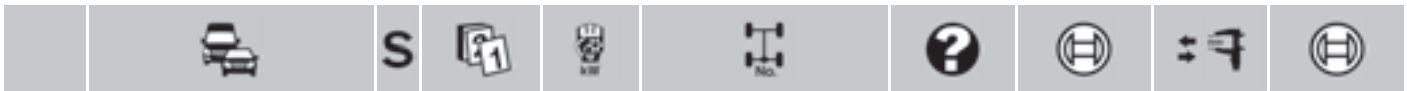

HYUNDAI

Accent

	1.5 i 12V	ABO 10.99→	69		F 026 A01 764
		ABS 10.99→	69		F 026 A01 765
	1.6 i 16V	ABO 10.01-09.08	76		F 026 A01 764
		ABS 10.01-09.08	76		F 026 A01 765

Accent blue [RB]

	1.4	01.11→	74/80		F 026 A09 571
		1.6 CRDi	01.11→	94	

Accent Hatchback [LC]

	1.3 i	ABO 08.99-03.06	53/55/61-63		F 026 A01 764
		ABS 08.99-03.06	53/55/61-63		F 026 A01 765
	1.5 CRDi	ABO 08.99-06.06	57-60/66/75		F 026 A01 764
		1.5 i	ABS 08.99-06.06	57-60/66/75	
	1.6 i	ABO 08.02-03.06	77		F 026 A01 764
		ABS 08.02-03.06	77		F 026 A01 765

Accent Hatchback [MC]

	1.4	04.06-02.12	71	LLE	F 026 A09 609	
		1.6	04.06-02.12	82	LLE	F 026 A09 609
	1.4	04.06-02.12	71		F 026 A09 571	
		1.5 CRDi	04.06-02.12	81		F 026 A09 571
		1.6	04.06-02.12	82		F 026 A09 571

Accent Hatchback [X3]

	1.3 i	ABO 07.94-07.97	43/44/55/62	JBH	0 986 480 863
		08.97-07.99	43/44/55/62		F 026 A01 770
	1.5 i	ABO 07.94-07.97	63/73	JBH	0 986 480 863
		08.97-07.99	63/73		F 026 A01 770
	1.3 i	07.94-10.97	43/44/55/62	LLE	F 026 A01 865
		07.94-07.99	43/44/55/62	RLE	F 026 A01 871
	1.5 i	07.94-10.97	63	LLE	F 026 A01 865
			65-68	LLE	F 026 A01 865
		07.94-07.99	63	RLE	F 026 A01 871
		11.95-10.97	73	LLE	F 026 A01 865
11.95-07.99	73	RLE	F 026 A01 871		
	1.3 i	07.94-05.96	43/44/55/62		F 026 A02 563
		1.5 i	07.94-05.96	63/65-68/73	

Accent [LC]

	1.3	ABO 05.99-03.06	44/55/61-63		F 026 A01 764
		ABS 05.99-03.06	44/55/61-63		F 026 A01 765





	◀ HYUNDAI Accent [LC]							
	1.5 CRDi	ABO	08.99-06.06	57-60/66/75		F 026	A01 764	
	1.5 i	ABS	08.99-06.06	57-60/66/75		F 026	A01 765	
	1.6 i	ABO	08.02-03.06	77		F 026	A01 764	
		ABS	08.02-03.06	77		F 026	A01 765	

Accent [MC, MCT]

	1.4		04.06-11.10	70-71	LLE	F 026	A09 609	
	1.6		04.06-02.12	82	LLE	F 026	A09 609	

	1.4		04.06-11.10	70-71		F 026	A09 571	
	1.5 CRDi		04.06-02.12	81		F 026	A09 571	
	1.6		04.06-02.12	82		F 026	A09 571	

Accent [RB]

	1.6		11.10→	92		F 026	A09 571	

Accent [X3]

	1.3 i	ABO	04.94-06.97	67	JBH	0986	480 863	
			07.94-07.97	43/44/55/62	JBH	0986	480 863	
			07.97-05.99	67		F 026	A01 770	
			08.97-07.99	43/44/55/62		F 026	A01 770	
	1.5 i	ABO	04.94-06.97	71	JBH	0986	480 863	
			07.94-07.97	63	JBH	0986	480 863	
			07.97-05.99	71		F 026	A01 770	
			08.97-07.99	63		F 026	A01 770	
	1.5 i 16V	ABO	11.95-07.97	73	JBH	0986	480 863	
			08.97-07.99	73		F 026	A01 770	

	1.3 i		07.94-10.97	43/44/55/62	LLE	F 026	A01 865	
			07.94-07.99	43/44/55/62	RLE	F 026	A01 871	
	1.5 i		07.94-10.97	63	LLE	F 026	A01 865	
				65-68	LLE	F 026	A01 865	
			07.94-07.99	63	RLE	F 026	A01 871	
	1.5 i 16V		11.95-10.97	73	LLE	F 026	A01 865	
			11.95-07.99	73	RLE	F 026	A01 871	

	1.3 i		07.94-05.96	43/44/55/62		F 026	A02 563	
	1.5 i, i 16V		07.94-05.96	63/65-68/73		F 026	A02 563	

Atos [MX]

	0.8 i	ABO	09.97-06.01	39-42	JBH, LLE	0986	480 991	20,64
	1.0 i	ABO	12.97-05.02	40/43	JBH, LLE	0986	480 991	20,64

Atos Prime [MX]

	1.0 i	ABO	09.99-06.01	40	JBH, LLE	0986	480 991	20,64





Avante [J2]

	1.5i	ABO	03.95-08.00	77	JBH	0 986 480 938	22,2

Azera

	2.7		11.07-12.10	125		0 265 005 751	

Coupé [GK]

	1.6i		03.02-08.09	76-79	RLE	F 026 A01 930	
	2.0i		10.01-08.09	101-105	RLE	F 026 A01 930	
	2.7iV6		10.01-11.04	121-123	GS	F 026 A01 930	
	1.6i		03.02-08.09	76-79	MG5	F 026 A06 948	
					MG6	0 986 486 605	20,6
	2.0i		10.01-08.09	101-105	MG5	F 026 A06 948	
					MG6	0 986 486 605	20,6
	2.7iV6		10.01-08.09	121-123	MG5	F 026 A06 948	
					MG6	0 986 486 605	20,6

Coupé [RD]

	1.6i	ABO	05.96-04.02	84-85	JBH,LLE	0 986 480 938	22,2
	2.0i	ABO	05.96-04.02	99-102	JBH,LLE	0 986 480 938	22,2
	1.6i		07.96-04.02	84-85	RLE	F 026 A01 872	
	2.0i		07.96-04.02	99-102	RLE	F 026 A01 872	
	1.6i		05.96-04.02	84-85		F 026 A02 568	
	1.8i		07.97-04.02	94		F 026 A02 568	
	2.0i		05.96-04.02	99-102		F 026 A02 568	

Elantra

	1.6i		11.03-04.09	82		F 026 A01 769	
	1.8i		10.03-09.11	96		F 026 A01 769	

Elantra Hatchback [XD]

	1.6 16V	ABO	06.00-08.06	66-79		F 026 A01 768	
		ABS	06.00-08.06	66-79	TKO	F 026 A01 769	
	1.8 16V	ABO	06.00-05.03	97		F 026 A01 768	
		ABS	06.03-08.06	97		F 026 A01 769	
	2.0 CRDi	ABO	06.00-09.06	83/102-105		F 026 A01 768	
	2.0 16V	ABS	06.00-09.06	83/102-105	TKO	F 026 A01 769	
	1.6 16V		06.00-11.04	66-79		F 026 A01 930	
	1.8 16V		06.00-11.04	97		F 026 A01 930	
	2.0 CRDi, 16V		06.00-11.04	83/102-105		F 026 A01 930	
	1.6 16V		06.00-08.06	66-79		F 026 A06 948	
	1.8 16V		06.00-08.06	97		F 026 A06 948	
	2.0 CRDi, 16V		06.00-09.06	83/102-105		F 026 A06 948	



		S				?			
◀ HYUNDAI									
Elantra [HD]									
	1.6, CRDi	08.06-06.11	85/90				F 026	A09 571	
	2.0	12.07-06.11	103-105				F 026	A09 571	
Elantra [J1]									
	1.5 i	ABO 06.93-04.95	53/63-66				F 026	A01 622	
		ABS 08.94-04.95	53/63-66				F 026	A01 623	
	1.6 i 16V	ABO 06.93-04.95	78-84				F 026	A01 622	
		ABS 08.94-04.95	78-84				F 026	A01 623	
	1.8 i 16V	ABO 06.93-04.95	93				F 026	A01 622	
		ABS 08.94-04.95	93				F 026	A01 623	
	1.5 i	10.90-04.95	53/63-66		RLE		F 026	A01 865	
	1.6 i 16V	10.90-04.95	78-84		RLE		F 026	A01 865	
	1.8 i 16V	06.92-04.95	93		RLE		F 026	A01 865	
	1.6 i 16V	10.90-04.95	78-84				F 026	A02 543	
	1.8 i 16V	06.92-04.95	93				F 026	A02 543	
Elantra [J2]									
	1.5 i	ABO 07.96-09.00	65-68		JBH,LLE		0986	480 938	22,2
	1.6 i 16V	ABO 05.95-09.00	84		JBH,LLE		0986	480 938	22,2
	1.8 i 16V	ABO 05.95-09.00	101		JBH,LLE		0986	480 938	22,2
	1.9 D	ABO 05.95-09.00	50		JBH,LLE		0986	480 938	22,2
	1.5 i	07.97-09.00	65-68		RLE		F 026	A01 872	
	1.6 i 16V	07.96-09.00	84		RLE		F 026	A01 872	
	1.8 i 16V	07.96-09.00	101		RLE		F 026	A01 872	
	1.9 D	07.96-09.00	50		RLE		F 026	A01 872	
	1.5 i	07.96-09.00	65-68				F 026	A02 568	
	1.6 i 16V	05.95-09.00	84				F 026	A02 568	
	1.8 i	08.95-12.99	94-97				F 026	A02 568	
	1.8 i 16V	05.95-09.00	101				F 026	A02 568	
	1.9 D	05.95-09.00	50				F 026	A02 568	
Elantra [MD, UD]									
	1.6, CRDi	02.11→	94/97				F 026	A09 571	
	1.8	02.11→	107-110				F 026	A09 571	
Elantra [XD]									
	1.6 16V	ABO 06.00-08.06	66-82				F 026	A01 768	
		ABS 06.00-08.06	66-82		TKO		F 026	A01 769	
	1.8 16V	ABO 06.00-05.03	97				F 026	A01 768	
		ABS 06.03-08.06	97				F 026	A01 769	
	2.0 CRDi	ABO 06.00-09.06	83/102-105				F 026	A01 768	
	2.0 16V	ABS 06.00-09.06	83/102-105		TKO		F 026	A01 769	
	1.6 16V	06.00-11.04	66-82				F 026	A01 930	
	1.8 16V	06.00-11.04	97				F 026	A01 930	
	2.0 CRDi, 16V	06.00-11.04	83/102-105				F 026	A01 930	



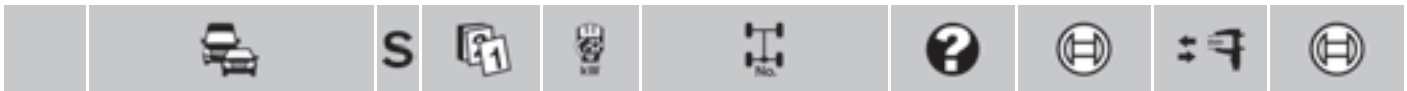

	1.6 16V	06.00-08.06	66-82		F 026 A06 948	
	1.8 16V	06.00-08.06	97		F 026 A06 948	
	2.0 CRDi, 16V	06.00-09.06	83/102-105		F 026 A06 948	

Excel Hatchback [X3]

	1.5 i	11.95-07.99	73	RLE	F 026 A01 871	
	1.5 i	11.95-05.96	73		F 026 A02 563	

Excel [X3]

	1.3 i	ABO 07.94-07.97	55	JBH	0 986 480 863	
		08.97-07.99	55		F 026 A01 770	
	1.5 i	ABO 07.94-07.97	65-68	JBH	0 986 480 863	
		08.97-07.99	65-68		F 026 A01 770	
	1.3 i	07.94-10.97	55	LLE	F 026 A01 865	
	1.5 i	07.94-10.97	65-68	LLE	F 026 A01 865	
		07.94-07.99	65-68	RLE	F 026 A01 871	
	1.5 i 16V	11.95-07.99	73	RLE	F 026 A01 871	
	1.3 i	07.94-05.96	55		F 026 A02 563	
	1.5 i, i 16V	07.94-05.96	65-68/73		F 026 A02 563	

Getz [TB]

	1.1	ABO 09.02-11.04	46-49	LLE	F 026 A09 544	
	1.3	ABO 09.02-11.04	60-63	LLE	F 026 A09 544	
		ABS 09.02-11.04	60-63	LLE	F 026 A09 545	
	1.6	ABO 09.02-11.04	77-78	LLE	F 026 A09 544	
	1.1	09.02-11.04	46-49	LLE	F 026 A09 617	
	1.3	09.02-11.04	60-63	LLE	F 026 A09 617	
	1.6	09.02-11.04	77-78	LLE	F 026 A09 617	
	1.5 CRDi	05.03-08.05	60		0 986 486 605	20,6
	1.1	09.02-06.09	46-49	STB	0 265 231 358^B	
	1.3	09.02-08.05	60-63		0 265 231 358^B	
	1.4	09.05-06.09	71	STB	0 265 231 358^B	
	1.6	09.02-06.09	77-78	STB	0 265 231 358^B	

Grace

	2.4 i Super	10.95→	90		0 265 103 072^H	
	2.5 D	10.95→	59		0 265 103 072^H	

Grandeur [TG]

	2.2 CRDi	11.07-11.10	110-114		0 265 005 751	
	2.7	11.07-11.10	141		0 265 005 751	
	3.3 24V	11.07→	171-173/191		0 265 005 751	



		S				?			
◀ HYUNDAI									
H 100									
	2.4 i	07.93-03.00	82-84/90				0 265 103 072 ^H		
	2.5 D, Intercooler, TCI, TD	02.93-09.04	55/57/59/63				0 265 103 072 ^H		
ix35 [LM, EL]									
	2.0	09.13→	112-113				F 026 A09 571		
ix35 [LM, EM]									
	2.0 4x4	09.13→	113				F 026 A09 571		
ix35 [LM,EL]									
	1.6 GDI	09.10→	99				F 026 A09 571		
	1.7 CRDi	09.10→	85				F 026 A09 571		
	2.0, 4x4	01.10-08.13	120-122				F 026 A06 948		
	2.0 GDI, GDI 4x4	09.13→	122				F 026 A09 571		
i20 [GB]									
	1.1 CRDi	11.14→	55				F 026 A09 571		
	1.4	11.14→	66/74				F 026 A09 571		
i30 Coupé [GD]									
	1.4, CRDi	02.13→	66/73				F 026 A09 571		
	1.6, CRDi, GDI	02.13→	81/88/92-95/ 99				F 026 A09 571		
i30 CW [FD/FDH]									
	1.4, LPG	03.09-09.12	76/77-80				F 026 A09 571		
	1.6, CRDi, LPG	02.08-09.12	66/85-93/94				F 026 A09 571		
	2.0, LPG	03.08-03.11	100/105				F 026 A09 571		
i30 CW [GD]									
	1.4, CRDi	03.12→	66/73				F 026 A09 571		
	1.6, CRDi, GDI	03.12→	81/88/92-95/ 99				F 026 A09 571		
i30 [FD/FDH]									
	1.4, LPG	12.07-12.11	76-80				F 026 A09 571		
	1.6, CRDi, LPG	12.07-08.12	66/81-93/94				F 026 A09 571		
	2.0, LPG	12.07-01.13	100/105				F 026 A09 571		



		S							
i30 [GD]									
	1.4, CRDi		12.11→	66/73			F 026	A09 571	
	1.6, CRDi, GDi		12.11→	81/88/92-95/99			F 026	A09 571	
i40 CW [VF]									
	1.6 GDI		04.11→	99			F 026	A09 571	
	2.0, GDI		04.11→	110/130			F 026	A09 571	
i40 [VF]									
	1.6 GDI		04.11→	99			F 026	A09 571	
	2.0, GDI		04.11→	110/131			F 026	A09 571	
Lantra [J1]									
	1.5 i	ABO	06.93-04.95	53/57/63			F 026	A01 622	
		ABS	08.94-04.95	53/57/63			F 026	A01 623	
	1.6 i 16V	ABO	06.93-04.95	78-84			F 026	A01 622	
		ABS	08.94-04.95	78-84			F 026	A01 623	
	1.8 i 16V	ABO	06.93-04.95	93			F 026	A01 622	
		ABS	08.94-04.95	93			F 026	A01 623	
	1.5 i		10.90-04.95	53/57/63	RLE		F 026	A01 865	
	1.6 i 16V		10.90-04.95	78-84	RLE		F 026	A01 865	
	1.8 i 16V		06.92-04.95	93	RLE		F 026	A01 865	
	1.6 i 16V		10.90-04.95	78-84			F 026	A02 543	
	1.8 i 16V		06.92-04.95	93			F 026	A02 543	
Lantra [J2]									
	1.5 i	ABO	07.96-09.00	65-68	JBH,LLE		0 986	480 938	22,2
	1.6 i 16V	ABO	05.95-09.00	66/84	JBH,LLE		0 986	480 938	22,2
	1.8 i 16V	ABO	05.95-09.00	94	JBH,LLE		0 986	480 938	22,2
	2.0 i 16V	ABO	08.96-09.00	102	JBH,LLE		0 986	480 938	22,2
	1.5 i		07.97-09.00	65-68	RLE		F 026	A01 872	
	1.6 i 16V		07.96-09.00	66/84	RLE		F 026	A01 872	
	1.8 i 16V		07.96-09.00	94	RLE		F 026	A01 872	
	2.0 i 16V		08.96-09.00	102	RLE		F 026	A01 872	
	1.5 i		07.96-09.00	65-68			F 026	A02 568	
	1.6 i 16V		05.95-09.00	66/84			F 026	A02 568	
	1.8 i 16V		05.95-09.00	94			F 026	A02 568	
	2.0 i 16V		08.96-09.00	102			F 026	A02 568	
Lantra Kombi [J2]									
	1.5 i	ABO	07.96-09.00	65	JBH,LLE		0 986	480 938	22,2
	1.6 i	ABO	05.95-09.00	66/84	JBH,LLE		0 986	480 938	22,2
	1.8 i	ABO	05.95-09.00	94	JBH,LLE		0 986	480 938	22,2
	2.0 i	ABO	08.96-09.00	102	JBH,LLE		0 986	480 938	22,2





◀ HYUNDAI Lantra Kombi [J2]

	1.5 i	07.97-09.00	65	RLE	F 026 A01 872
	1.6 i	07.96-09.00	66/84	RLE	F 026 A01 872
	1.8 i	07.96-09.00	94	RLE	F 026 A01 872
	2.0 i	08.96-09.00	102	RLE	F 026 A01 872

	1.5 i	07.96-09.00	65		F 026 A02 568
	1.6 i	05.95-09.00	66/84		F 026 A02 568
	1.8 i	05.95-09.00	94		F 026 A02 568
	2.0 i	08.96-09.00	102		F 026 A02 568

Matrix [FC]



	1.5 CRDi	07.01-01.06	60		F 026 A06 948
	1.6 i	08.01-04.10	66/76		F 026 A06 948
	1.8 i	08.01-04.10	90		F 026 A06 948

Pony [X3]



	1.3 i	ABO 07.94-07.97	62	JBH	0 986 480 863
		08.97-07.99	62		F 026 A01 770

	1.3 i	07.94-10.97	62	LLE	F 026 A01 865
		07.94-07.99	62	RLE	F 026 A01 871

	1.3 i	07.94-05.96	62		F 026 A02 563
--	-------	-------------	----	--	----------------------

Santa Fe [CM]



	2.2 CRDi, CRDi 4x4	01.08-11.09	110-114		0 265 005 751
	2.7 i, i 4x4	01.08-11.09	125-139		0 265 005 751

Santa Fe [SM]



	2.0 CRDi 4x4, i	01.01-12.05	83/100		F 026 A06 948
	2.4 i, i 4x4	02.00-12.05	100/107		F 026 A06 948
	2.7 i 4x4	09.99-12.05	127-132		F 026 A06 948

Santa Fe [DM]



	2.0 CRDi	04.01-12.05	83		F 026 A06 948
--	----------	-------------	----	--	----------------------

Solaris Hatchback [RB]



	1.4	01.11→	79		F 026 A09 571
	1.6	01.11→	90		F 026 A09 571

Solaris [RB]



	1.4	01.11→	79		F 026 A09 571
	1.6	01.11→	90-91		F 026 A09 571





Sonata [EF]

	2.0i, LPG	03.98-07.01	100/108		RLE	F 026 A06 913
	2.4i	05.98-03.01	105		RLE	F 026 A06 913
	2.5i	03.98-03.01	118/129		RLE	F 026 A06 913
	1.8i	03.98-03.01	98			F 026 A06 948
	2.0i, LPG	03.98-07.01	96-98/100/108			F 026 A06 948
	2.4i	05.98-03.01	105			F 026 A06 948
	2.5i	03.98-03.01	118/129			F 026 A06 948
	2.7i	04.01-07.01	127-132			F 026 A06 948
	2.0i	04.01-11.04	96-98		LLE	0 265 216 877^B
		03.02-11.04	96-98			0 265 220 653^F
		12.03-09.11	101			0 265 216 915^H
	2.7i	04.01-01.06	127-132		LLE	0 265 216 877^B
		03.02-01.06	127-132			0 265 220 655^F
		12.03-05.06	127-131			0 265 216 915^H

Sonata [NF]

	2.0, CRDi	01.08-12.10	106-121			0 265 005 751
	3.3	01.08-12.10	184			0 265 005 751

Sonata [YF]

	2.0	12.13→	121			F 026 A09 571

Trajet [FO]

	2.0 CRDi	01.01-06.07	83-92			F 026 A06 948

Tucson [JM]

	2.0 CRDi	11.06-03.10	100-103/		LLE	0 986 049 550
	2.0 CRDi 4x4		110			
	2.0 CRDi, CRDi 4x4, i, i 4x4	08.04-03.10	83/100-103/ 104-105/110			F 026 A06 948
	2.7 4x4	09.04-03.10	129			F 026 A06 948

Veloster [FS]

	1.6	06.11→	97/103			F 026 A09 571
	1.6 GDI					

Verna [LC]

	1.5 i Lean Burn	ABO 07.99-03.06	70			F 026 A01 764
		ABS 07.99-03.06	70			F 026 A01 765





◀ HYUNDAI

XG [F]					
	25 2.5i	12.98-12.05	120		F 026 A06 948
	30 3.0i	12.98-12.05	138		F 026 A06 948
	35 3.5i	08.02-12.05	145		F 026 A06 948

INFINITI

























EX [J50]					
	25 4x4	02.11→	163		0 204 023 644
	30 d 4x4	04.10→	175	GBM,LLE	0 204 023 644
				GBM,RLE	0 204 023 643
	35 4x4	04.08-01.10	222		0 204 023 647
	37 4x4	06.08→	235-243	GBM,LLE	0 204 023 644
				GBM,RLE	0 204 023 643
		01.10-12.10	235-243	GBM,LLE	0 204 023 647
	37 4x4	06.08-05.09	235-243	GBM	0 265 230 419 ^T
				GBM	0 265 230 417 ^T
	25 4x4	02.11→	163		0 265 005 806
	30 d 4x4	04.10→	175		0 265 005 806
	35 4x4	04.08-01.10	222		0 265 005 806
	37 4x4	06.08→	235-243		0 265 005 806

FX [S51]					
	30 d 4x4	03.10→	175	GBM,LLE	0 204 023 643
				GBM,RLE	0 204 023 644
	35 4x4	09.08-01.10	228		0 204 023 643
	37 4x4	07.08→	235-245	GBM,LLE	0 204 023 643
				GBM,RLE	0 204 023 644
	50 4x4	07.08→	287-294	LLE	0 204 023 643
	30 d 4x4	03.10→	175		0 265 005 806
	35 4x4	09.08-01.10	228		0 265 005 806
	37 4x4	07.08→	235-245		0 265 005 806
	50 4x4	07.08→	287-294		0 265 005 806





























FX50 [S51]					
	5.0 4x4	06.13→	309		0 204 023 643
	5.0 4x4	06.13→	309		0 265 005 806

G Cabrio [HV36]























	37	06.09→	235-245	AG,GBM,RLE	0 204 023 643
				GBM,LLE	0 204 023 644
				GS,RLE	0 204 023 643
	37	06.09→	235-245		0 265 005 806

		S							
G Coupé [CV36]									
									
	37	10.07→	235-245			AG,GBM,LLE	0 204 023 644		
						GBM,RLE	0 204 023 643		
						GS,LLE	0 204 023 644		
	37	06.08→	235-245			LLE			0 204 053 291
	37	10.07-11.08	235-245			TW	0 265 235 450 ^T		
	37	10.07→	235-245				0 265 005 806		
G [V36]									
									
	25	01.10-10.10	163				0 204 023 644		
	35 4x4	12.06-12.08	232				0 204 023 644		
	37	07.08→	235-243			AG,GBM,LLE	0 204 023 644		
						GS,LLE	0 204 023 644		
	37, 4x4	07.08→	235-243			GBM,RLE	0 204 023 643		
	37 4x4	07.08→	235-243			GBM,LLE	0 204 023 644		
	35 4x4	12.06-12.08	232				0 265 234 566 ^T		
	25	01.10→	163				0 265 005 806		
	35 4x4	12.06-12.08	232				0 265 005 693		
	37	01.10→	235-243				0 265 005 806		
	37 4x4	07.08→	235-243				0 265 005 806		
G35 [V35]									
									
	3.5	08.04-08.06	209				F 01G 09D 0AR ^H		
	3.5	08.04-06.06	209				F 01G 09F 0MT		
M [Y50]									
									
	35, 4x4	07.06-05.10	206/226						0 204 023 121
	45	07.06-05.10	250						0 204 023 121
	35	07.06-01.08	206				0 265 234 572 ^T		
	35 4x4	07.06-01.08	206				0 265 234 553 ^T		
	45	07.06-01.08	250				0 265 234 600 ^T		
						ALE	0 265 234 551 ^T		
	35, 4x4	02.08-05.10	206/226				0 265 005 693		
	45	02.08-05.10	250				0 265 005 806		







































									
◀ INFINITI									
QX [A60]									
									
	56 4x4	04.08→	239			TW	F 01G 09F 0MT		
QX50									
									
	3.0	10.13→	175			TW	0 204 023 644		
	3.7	10.13→	235			TW	0 204 023 644		
	3.0	10.13→	175				0 265 005 806		
	3.7	10.13→	235				0 265 005 806		
QX56 [A60]									
									
	5.6 4x4	10.04-08.10	235				F 01G 09F 0MT		
QX70 [S51]									
									
	3.7 AWD	11.13→	235				0 204 023 643		
	5.0 AWD	11.13→	287				0 204 023 643		
	3.0 Turbo AWD	11.13→	175				0 265 005 806		
	5.0 AWD	11.13→	287				0 265 005 806		
Q60 Cabrio									
									
	3.7	10.13→	235			TW	0 204 023 644		
	3.7	10.13→	235				0 265 005 806		
Q60 Coupé									
									
	3.7	10.13→				TW	0 204 023 644		
	3.7	10.13→					0 265 005 806		
ISUZU									
Frontier [TF140]									
									
	3.2 i4WD	05.97→	142				F 01G 09C 1B8		
		01.01→	142				F 01G 09C 1BB		
	3.2 i4WD	05.97→	142				F 01G 09B 1JE		





















		S							
Serie N									
									
	NHR55E TD 2.8, 2.8	02.06-12.08	67/70				F 01G 09C 1AN		
	NKR55L 2.8	02.06-12.08	67				F 01G 09C 1AN		
	NPR66L 4.3	09.99-12.06	78				F 01G 09C 138	F 01G 09C 137⁶	
	NPR66P 4.3	09.99-12.06	78				F 01G 09C 138	F 01G 09C 137⁶	
	NPR300 4.3	09.08→	78				F 01G 19C 02T	F 01G 09C 138	
	NQR75-R 5.2 TD	02.06-12.08	129					F 01G 29C 016⁶	
	NQR500 5.2	02.08→	110				F 01G 29L 01N		
	N250T 2.8 Carrier	02.06-12.07	67				F 01G 09C 1AN		
	NQR75-R 5.2 TD	02.06-12.08	129				F 01G 060 1AM^S		
Serie N [700N]									
									
	NLR150T 2.9 Carrier	09.08→	96				F 01G 19C 02T	F 01G 09C 138	
	NMR250T 2.9 Carrier	09.08→	96				F 01G 19C 02T	F 01G 09C 138	
	NPR400 5.2	09.08→	110				F 01G 29L 01N		
	NPS300 5.2 4x4	09.08→	110				F 01G 19C 02T	F 01G 09C 138	
	NLR150T 2.9 Carrier	09.08→	96				F 01G 061 0PY		
	NMR250T 2.9 Carrier	09.08→	96				F 01G 061 0PY		
	NPS300 5.2 4x4	09.08→	110				F 01G 061 0PY		
Trooper [UB]									
									
	3.2i 24V 4WD	11.94-09.04	130				F 01G 09E 00W^H		
IVECO									
CityClass									
									
	2.8	10.05-07.07	92				0 204 123 413		
	45 S 17	10.12→	125		JBH		F 026 003 140	25,4	
	2.8	10.05-07.07	92				0 204 125 519		
	45 S 17	10.12→	125				0 204 125 828		
Daily									
									
	30 -8, -10 Turbo	02.91-05.99	55/60/76		JBH		F 026 003 149	20,6	
	35 -8, -10 Turbo	02.91-03.98	55/60/66,1-68,9		JBH		F 026 003 149	20,6	
	35 -10 Turbo	07.92-04.97	80		JBH,R14		F 026 003 149	20,6	
					JBH,R16		F 026 003 140	25,4	
		05.96-05.99	76		JBH,R14		F 026 003 149	20,6	
					JBH,R16		F 026 003 140	25,4	
	35 -10 Turbo I.D.	07.92-04.97	80		JBH		F 026 003 149	20,6	
	40 -8, -10 Turbo 4x4	07.89-04.96	55/76		JBH		F 026 003 149	20,6	
	45 S 17	04.12→	125		JBH		F 026 003 140	25,4	
	60 .12	10.02-07.07	90				0 204 123 413		
	A40 -10 Turbo	05.96-05.99	76				0 204 125 459		
	A45 -10 Turbo	07.89-05.99	76				0 204 125 459		
		05.96-05.99	76				0 204 125 520^S		

		S							
	IVECO Daily								
	A45 -12 Turbo	05.96-05.99	90				0 204 125 520 ^S		
	A49 -10 Turbo	05.96-05.99	76				0 204 125 459		
							0 204 125 520 ^S		
	30 -8	02.91-03.98	55/60				0 204 125 393		
	35 -8	02.91-04.96	55				0 204 125 393		
		05.96-03.98	60				0 204 125 393		
							0 204 125 520 ^S		
	35 -10 Turbo	05.96-05.99	76				0 204 125 520 ^S		
		ABO 09.89-04.96	76			FFZ	0 204 125 391 ^S		
						FFZ,OZB	0 204 125 318		
						FFZ,ZWB	0 204 125 299		
							0 204 125 393 ^S		
		07.91-04.96	66,1-68,9			FFZ,OZB	0 204 125 318		
						FFZ,ZWB	0 204 125 299		
							0 204 125 393 ^S		
	35 -10 Turbo	ABO 07.92-04.97	77,5-83			FFZ,OZB	0 204 125 318		
	35 -10 Turbo I.D.					FFZ,ZWB	0 204 125 299		
							0 204 125 393 ^S		
		ABS 09.89-04.97	66,1-68,9/76/77,5-83				0 204 125 459 ^S		
	35 -12 Turbo	10.90-04.96	85				0 204 125 459		
		05.96-05.99	90				0 204 125 459		
							0 204 125 520 ^S		
	40 -8	07.89-04.96	55				0 204 125 393		
	45 S 17	04.12→	125				0 204 125 828		
	49 -10 Turbo	05.96-05.99	76				0 204 125 520 ^S		
	49 -12 Turbo	06.90-04.96	85				0 204 125 459		
		05.96-05.99	90				0 204 125 459		
							0 204 125 520 ^S		
	59 -12 Turbo	05.91-04.96	85				0 204 125 430		
	60 .12	10.02-07.07	90				0 204 125 519		
	35 -10 Turbo	07.92-05.99	76/80			HTB	0 204 131 236		
		ABS 07.92-05.99	76/80				0 204 131 217		
	45 S 17	04.12→	125				0 204 031 119		
	A45 -10 Turbo, -12 Turbo	02.90-04.96	76/85				0 265 105 020 ^H		
	30 -8	02.91-04.96	55				0 265 105 020 ^H		
	35 -8, -10 Turbo, -10 Turbo I.D., -12 Turbo	10.90-04.97	55/66,1-68,9/80/85				0 265 105 020 ^H		
	40 -8, -10 Turbo 4x4	02.90-04.96	55/76				0 265 105 020 ^H		
	49 -12 Turbo	06.90-04.96	85				0 265 105 020 ^H		
	59 -12 Turbo	05.91-04.96	85				0 265 105 020 ^H		
Daily Chassi									
	35 S 14	08.07-03.12	100			JBH	F 026 003 140	25,4	
	35 .13	10.05-07.07	92			JBH	F 026 003 140	25,4	
	40 .13	10.05-07.07	92			JBH	F 026 003 140	25,4	
	50 .13	10.05-07.07	92			JBH	F 026 003 140	25,4	
	70 .13	10.05-07.07	92			JBH	F 026 003 140	25,4	
	35 S 14	08.07-03.12	100				0 204 125 828		
	35 .13	10.05-07.07	92				0 204 125 266		
	40 .13	10.05-07.07	92				0 204 125 266		
	50 .13	10.05-07.07	92				0 204 125 266		
	70 .13	10.05-07.07	92				0 204 125 266		
	35 S 14	08.07-03.12	100				0 204 031 119		
	55 C 16, 17	08.07→	114/125				0 204 031 119		













		S							
Daily Furgao									
									
	35 S 14	08.07-03.12	100			JBH	F 026 003 140	25,4	
	38 .13	10.05-07.07	92			JBH	F 026 003 140	25,4	
	40 .13	10.05-07.07	92			JBH	F 026 003 140	25,4	
	45 S 17	04.12→	125			JBH	F 026 003 140	25,4	
	50 .13	10.05-07.07	92			JBH	F 026 003 140	25,4	
	35 S 14	08.07-03.12	100				0 204 125 828		
	38 .13	10.05-07.07	92				0 204 125 266		
	40 .13	10.05-07.07	92				0 204 125 266		
	45 S 17	04.12→	125				0 204 125 828		
	50 .13	10.05-07.07	92				0 204 125 266		
	35 S 14	08.07-03.12	100				0 204 031 119		
	45 S 17	04.12→	125				0 204 031 119		
	55 C 17	04.12→	125			TW	0 265 233 028 ^F		
Daily MaxiVan									
									
	40 S 16	08.07-03.12	114			JBH	F 026 003 140	25,4	
	40 .13	10.05-07.07	92			JBH	F 026 003 140	25,4	
	50 .13	10.05-07.07	92			JBH	F 026 003 140	25,4	
	40 S 16	08.07-03.12	114				0 204 125 828		
	40 .13	10.05-07.07	92				0 204 125 266		
	50 .13	10.05-07.07	92				0 204 125 266		
	40 S 16	08.07-03.12	114				0 204 031 119		
	55 C 16	08.07-03.12	114				0 204 031 119		
Daily Vetrato									
									
	45 S 17	04.12→	125			JBH	F 026 003 140	25,4	
	45 S 17	04.12→	125				0 204 125 828		
Daily [00]									
									
	29 L 12	09.02-03.06	85				0 204 123 537		
	35 S 11	09.03-08.06	78				0 204 123 537		
	29 L 12	09.02-03.06	85				0 204 125 828		
	35 S 11	09.03-08.06	78				0 204 125 828		
	50 C 11, 13, 14, 15, 17	05.99-08.06	78/92/100/108/122				0 204 021 854 ^S		
	65 C 11, 14, 15, 17	05.00-08.06	78/100/108/122				0 204 051 360 ^S		
	29 L 10, 12, 14	09.02-03.06	70/85/100				0 204 131 380		
	35 C 10	09.02-03.06	70				0 204 031 119 ^A		
	35 C 11, 12, 13	05.99-03.06	78/85/92			TW	0 204 021 150 ^A		
							0 204 031 119 ^A		
	35 C 14	09.04-03.06	100				0 204 131 380		
						TW	0 204 021 150 ^A		
							0 204 031 119 ^A		











		S							
IVECO Daily [00]									
	35 C 15	05.01-03.06	108/122			TW	0 204 021 150 ^A		
	35 C 17						0 204 031 119 ^A		
	35 C 9	05.99-09.04	62/66			TW	0 204 021 150 ^A		
							0 204 031 119 ^A		
	35 S 10, 11, 12, 13, 14, 15, 17, 9	05.99-08.06	62/66/70/78/85/92/100/108/122				0 204 131 380		
	50 C 11, 13, 15	05.99-08.06	78/92/108			TW	0 204 021 150 ^A		
							0 204 031 119 ^A		
	65 C 15	05.00-09.04	108				0 204 031 119 ^A		
	29 L 12	09.02-03.06	85				0 265 231 451 ^B		
	50 C 13	05.99-09.04	92				0 265 219 427 ^F		
							0 265 231 453 ^B		
Daily [06]									
	29 L 10, 12, 14	04.06-12.11	71/85/100			JBH	F 026 003 140	25,4	
	35 C 10, 12, 14, 15, 18	04.06-12.11	71/85/100/107/130			JBH	F 026 003 140	25,4	
	35 S 10, 12, 14, 15, 18	04.06-12.11	71/85/100/107/130			JBH	F 026 003 140	25,4	
	65 C 14, 15, 18	04.06-12.11	100/107/ 130			TW	0 204 123 732	31,75	
							0 204 123 733	31,75	
	29 L 10, 12, 14	04.06-12.11	71/85/100				0 204 125 828		
	35 C 10	04.06-12.11	71				0 204 125 828		
	35 C 12	04.06-12.11	85/100				0 204 125 828		
	35 C 14			Fg.-Nr. →5552507, →D278216		TW	0 204 051 360 ^S		
				Fg.-Nr. 5552508→, D278217→		TW	0 204 051 361 ^S		
	35 C 15, 18	04.06-12.11	107/130				0 204 125 828		
	35 S 10	04.06-12.11	71				0 204 125 828		
	35 S 12	04.06-12.11	85				0 204 125 828		
				Fg.-Nr. →5552507, →D278216		TW	0 204 051 360 ^S		
				Fg.-Nr. 5552508→, D278217→		TW	0 204 051 361 ^S		
	35 S 14	04.06-12.11	100				0 204 125 828		
	35 S 15	04.06-05.09	107				0 204 125 828		
				Fg.-Nr. →5552507, →D278216		TW	0 204 051 360 ^S		
				Fg.-Nr. 5552508→, D278217→		TW	0 204 051 361 ^S		
	35 S 18	04.06-12.11	130				0 204 125 828		
	40 C 12, 14, 15, 18	04.06-12.11	85/100/ 107/130	Fg.-Nr. →5552507, →D278216		LLE	0 204 051 360 ^S		
				Fg.-Nr. 5552508→, D278217→		LLE	0 204 051 361 ^S		
	50 C 14	04.07-12.11	100	Fg.-Nr. →5552507, → D278216		LLE,TW	0 204 051 360 ^S		
				Fg.-Nr. 5552508→, D278217→		LLE,TW	0 204 051 361 ^S		
	55 S 18	04.06-12.11	130	Fg.-Nr. →5552507, →D278216		LLE	0 204 051 360 ^S		
				Fg.-Nr. 5552508→, D278217→		LLE	0 204 051 361 ^S		
	65 C 14	04.06-12.11	100/107/				0 204 125 899		
	65 C 15		130	Fg.-Nr. →5552507, →D278216		TW	0 204 051 360 ^S		
	65 C 18			Fg.-Nr. 5552508→, D278217→		TW	0 204 051 361 ^S		
	29 L 10, 12, 14	04.06-12.11	71/85/100				0 204 131 380		
	35 C 10, 12	04.06-12.11	71/85				0 204 031 119 ^A		

		S							
35 C 14, 15				04.06-12.11	100/107		0 204 131 380		
35 C 18				04.06-12.11	130		0 204 031 119^A		
35 S 10, 12, 14, 15, 18				04.06-12.11	71/85/100/107/130		0 204 131 380		
50 C 15				04.06-12.11	107	TW	0 204 021 150^A		
							0 204 031 119^A		
55 S 18				04.06-12.11	130		0 204 131 380		
 29 L 10				04.06-12.11	71/85/100	TW	0 265 231 892^B		
29 L 12							0 265 232 412^B		
29 L 14							0 265 233 360^F		
							0 265 233 376^F		
							0 265 234 749^T		
35 C 10				04.06-12.11	71	TW	0 265 231 892^B		
							0 265 231 896^B		
							0 265 233 028^F		
							0 265 233 360^F		
							0 265 234 522^T		
35 C 12				04.06-12.11	85	TW	0 265 233 360^F		
							0 265 231 892^B		
							0 265 231 896^B		
							0 265 232 414^B		
							0 265 233 028^F		
							0 265 233 360^F		
							0 265 234 522^T		
35 C 14				04.06-05.09	100	TW	0 265 231 892^B		
							0 265 233 028^F		
							0 265 233 360^F		
							0 265 234 522^T		
				04.07-12.11	100	TW	0 265 233 360^F		
							0 265 231 892^B		
							0 265 231 896^B		
35 C 15, 18				04.06-12.11	107/130	TW	0 265 231 892^B		
							0 265 231 896^B		
							0 265 232 414^B		
							0 265 233 028^F		
							0 265 233 360^F		
							0 265 233 378^F		
							0 265 234 522^T		
							0 265 234 528^T		
							0 265 234 751^T		
35 S 10				04.06-12.11	71	TW	0 265 231 892^B		
							0 265 232 412^B		
							0 265 233 360^F		
							0 265 233 376^F		
35 S 12				04.06-05.09	85	TW	0 265 233 360^F		
							0 265 233 376^F		
							0 265 234 749^T		
				04.06-12.11	85	TW	0 265 233 360^F		
							0 265 231 892^B		
							0 265 232 412^B		
35 S 14				04.06-12.11	100		0 265 231 892^B		
							0 265 233 360^F		
				04.07-12.11	100	TW	0 265 231 892^B		
							0 265 232 412^B		
							0 265 233 360^F		
							0 265 233 376^F		
							0 265 234 749^T		
35 S 15				04.06-05.09	107	TW	0 265 233 360^F		
							0 265 231 892^B		
							0 265 232 412^B		
35 S 18				04.06-12.11	130	TW	0 265 231 892^B		
							0 265 232 412^B		

									
 ◀ IVECO Daily [06]									
35 S 18		04.06-12.11	130			TW	0 265 233 360 ^F		
							0 265 233 376 ^F		
							0 265 234 749 ^T		
40 C 10		04.06-05.09	71			TW	0 265 231 892 ^B		
							0 265 231 896 ^B		
							0 265 233 028 ^F		
							0 265 233 360 ^F		
40 C 12		04.06-05.09	85			TW	0 265 231 892 ^B		
							0 265 231 896 ^B		
							0 265 233 028 ^F		
							0 265 233 360 ^F		
							0 265 234 522 ^T		
40 C 14		04.07-12.11	100			TW	0 265 231 892 ^B		
							0 265 231 896 ^B		
							0 265 232 414 ^B		
							0 265 233 028 ^F		
							0 265 233 360 ^F		
							0 265 233 378 ^F		
							0 265 234 522 ^T		
							0 265 234 751 ^T		
40 C 15		04.06-12.11	107			TW	0 265 231 892 ^B		
							0 265 231 896 ^B		
							0 265 232 414 ^B		
							0 265 233 028 ^F		
							0 265 233 360 ^F		
							0 265 233 378 ^F		
							0 265 234 522 ^T		
							0 265 234 528 ^T		
							0 265 234 751 ^T		
40 C 18		04.06-12.11	130			TW	0 265 231 892 ^B		
							0 265 231 896 ^B		
							0 265 232 414 ^B		
							0 265 233 028 ^F		
							0 265 233 360 ^F		
							0 265 233 378 ^F		
							0 265 234 522 ^T		
							0 265 234 751 ^T		
45 C 15		04.06-12.11	107/130				0 265 231 892 ^B		
45 C 18							0 265 233 360 ^F		
50 C 12		04.06-12.11	85				0 265 231 892 ^B		
							0 265 233 360 ^F		
50 C 14		04.07-12.11	100			TW	0 265 231 892 ^B		
							0 265 231 896 ^B		
							0 265 233 028 ^F		
							0 265 233 360 ^F		
							0 265 233 378 ^F		
							0 265 234 522 ^T		
							0 265 234 751 ^T		
50 C 15		04.06-12.11	107/130			TW	0 265 231 892 ^B		
50 C 18							0 265 231 896 ^B		
							0 265 232 414 ^B		
							0 265 233 028 ^F		
							0 265 233 360 ^F		
							0 265 233 378 ^F		
							0 265 234 522 ^T		
							0 265 234 751 ^T		
55 S 18		04.06-12.11	130				0 265 231 892 ^B		
							0 265 233 360 ^F		
60 C 15		04.06-12.11	107/130				0 265 231 892 ^B		
60 C 18							0 265 233 360 ^F		
65 C 14		04.06-12.11	100/107/			TW	0 265 231 892 ^B		
65 C 15			130				0 265 231 894 ^B		
65 C 18							0 265 232 416 ^B		



		S							
65 C 14			04.06-12.11	100/107/		TW	0 265 233 026 ^F		
65 C 15				130			0 265 233 360 ^F		
65 C 18							0 265 233 380 ^F		
							0 265 234 524 ^T		
							0 265 234 753 ^T		
Daily [09]									
									
	35 C 11, 13, 14, 17		04.07-12.11	78/93/100/125		JBH	F 026 003 140	25,4	
	35 S 11, 13, 14, 17		06.09-12.11	78/93/103/125		JBH	F 026 003 140	25,4	
	65 C 17		06.09-12.11	125		JBH, TW	F 026 003 140	25,4	
						TW	0 204 123 732	31,75	
							0 204 123 733	31,75	
	70 C 14		11.10-12.11	103		TW	0 204 123 732	31,75	
							0 204 123 733	31,75	
	70 C 15		06.10-12.11	107/125/		JBH, TW	F 026 003 140	25,4	
	70 C 17			130		TW	0 204 123 732	31,75	
	70 C 18						0 204 123 733	31,75	
	35 C 11		04.07-12.11	78/93/100			0 204 125 828		
	35 C 13					TW	0 204 051 360 ^S		
	35 C 14								
	35 C 17		06.09-12.11	125			0 204 125 828		
	35 S 11		06.09-12.11	78/93			0 204 125 828		
	35 S 13					TW	0 204 051 360 ^S		
	35 S 14		06.09-12.11	103			0 204 125 828		
	35 S 17		06.09-12.11	125			0 204 125 828		
						TW	0 204 051 360 ^S		
	40 C 11		06.09-12.11	78		Fg.-Nr. →5552507, →D278216	LLE, TW	0 204 051 360 ^S	
						Fg.-Nr. 5552508→, D278217→	LLE, TW	0 204 051 361 ^S	
	40 C 13, 14, 17		06.09-12.11	93/103/ 125		Fg.-Nr. →5552507, →D278216	LLE	0 204 051 360 ^S	
						Fg.-Nr. 5552508→, D278217→	LLE	0 204 051 361 ^S	
	50 C 17		06.09-12.11	125		Fg.-Nr. →5552507, →D278216	LLE, TW	0 204 051 360 ^S	
						Fg.-Nr. 5552508→, D278217→	LLE, TW	0 204 051 361 ^S	
	55 S 17		06.09-12.11	125				0 204 051 360 ^S	
	65 C 17		06.09-12.11	125			TW	0 204 125 828	
								0 204 125 899	
	70 C 14		11.10-12.11	103				0 204 125 899	
	70 C 15		06.10-12.11	107			TW	0 204 125 828	
								0 204 125 899	
	70 C 17		06.10-12.11	125/130				0 204 125 899	
	70 C 18						TW	0 204 125 828	
	35 C 11, 13, 14, 17		04.07-12.11	78/93/100/125				0 204 131 380	
	35 S 11, 13, 14, 17		06.09-12.11	78/93/103/125				0 204 131 380	
	55 S 17		06.09-12.11	125				0 204 131 380	
	35 C 11		04.07-12.11	78/93/100				0 265 231 892 ^B	
	35 C 13							0 265 231 896 ^B	
	35 C 14							0 265 232 414 ^B	
								0 265 233 028 ^F	

								
 ◀ IVECO Daily [09]								
35 C 11	04.07-12.11	78/93/100			TW	0 265 233 360 ^F		
35 C 13						0 265 233 378 ^F		
35 C 14						0 265 234 522 ^T		
						0 265 234 751 ^T		
35 C 14	06.09-12.11	103				0 265 231 892 ^B		
						0 265 233 360 ^F		
35 C 17	06.09-12.11	125			TW	0 265 231 892 ^B		
						0 265 231 896 ^B		
						0 265 232 414 ^B		
						0 265 233 028 ^F		
						0 265 233 360 ^F		
						0 265 233 378 ^F		
						0 265 234 522 ^T		
						0 265 234 751 ^T		
35 S 11	06.09-12.11	78/93			TW	0 265 231 892 ^B		
35 S 13						0 265 232 412 ^B		
						0 265 233 360 ^F		
						0 265 233 376 ^F		
						0 265 234 749 ^T		
35 S 14	06.09-12.11	103				0 265 231 892 ^B		
						0 265 233 360 ^F		
					TW	0 265 234 749 ^T		
35 S 17	06.09-12.11	125			CS2,TW	0 265 216 845 ^B		
					TW	0 265 231 892 ^B		
						0 265 232 412 ^B		
						0 265 233 360 ^F		
						0 265 233 376 ^F		
						0 265 234 749 ^T		
35 S 18	11.10-12.11	130				0 265 231 892 ^B		
						0 265 233 360 ^F		
40 C 11, 13	06.09-12.11	78/93			TW	0 265 231 892 ^B		
						0 265 231 896 ^B		
						0 265 232 414 ^B		
						0 265 233 028 ^F		
						0 265 233 360 ^F		
						0 265 233 378 ^F		
						0 265 234 522 ^T		
						0 265 234 751 ^T		
40 C 14	06.09-12.11	103				0 265 231 892 ^B		
					TW	0 265 233 028 ^F		
						0 265 233 360 ^F		
						0 265 234 751 ^T		
40 C 17	06.09-12.11	125			TW	0 265 231 892 ^B		
						0 265 231 896 ^B		
						0 265 232 414 ^B		
						0 265 233 028 ^F		
						0 265 233 360 ^F		
						0 265 233 378 ^F		
						0 265 234 522 ^T		
						0 265 234 751 ^T		
45 C 14, 15, 17	07.09-12.11	103/107/ 125				0 265 231 892 ^B		
						0 265 233 360 ^F		
50 C 14	06.09-12.11	103/125			TW	0 265 231 892 ^B		
50 C 17						0 265 231 896 ^B		
						0 265 232 414 ^B		
						0 265 233 028 ^F		
						0 265 233 360 ^F		
						0 265 233 378 ^F		
						0 265 234 522 ^T		
						0 265 234 751 ^T		
55 S 17	06.09-12.11	125				0 265 233 360 ^F		
					CS2,TW	0 265 216 845 ^B		
					TW	0 265 231 892 ^B		



		S							
60 C 14		11.10-12.11	103				0 265 231 892 ^B		
							0 265 233 360 ^F		
65 C 14		06.09-12.11	103				0 265 231 892 ^B		
							0 265 233 360 ^F		
65 C 17		06.09-12.11	125		TW		0 265 231 892 ^B		
							0 265 231 894 ^B		
							0 265 232 416 ^B		
							0 265 233 026 ^F		
							0 265 233 360 ^F		
							0 265 233 380 ^F		
							0 265 234 524 ^T		
							0 265 234 753 ^T		
70 C 14		11.10-12.11	103		TW		0 265 231 892 ^B		
							0 265 231 894 ^B		
							0 265 232 416 ^B		
							0 265 233 026 ^F		
							0 265 233 360 ^F		
							0 265 233 380 ^F		
							0 265 234 524 ^T		
70 C 15		06.10-12.11	107/125/		TW		0 265 231 892 ^B		
70 C 17			130				0 265 231 894 ^B		
70 C 18							0 265 232 416 ^B		
							0 265 233 026 ^F		
							0 265 233 360 ^F		
							0 265 233 380 ^F		
							0 265 234 524 ^T		
							0 265 234 753 ^T		

Daily [12]

	29 L 11, 13, 15	07.11-07.14	78/93/146		JBH, TW	F 026 003 140	25,4	
					TW	0 204 123 775	25,4	
	35 C 11, 13, 14 CNG, 15, 17, 21	07.11-07.14	78/93/100/107/ 125/150		JBH, TW	F 026 003 140	25,4	
					TW	0 204 123 775	25,4	
	35 S 11, 13, 14 CNG, 15, 17, 21	07.11-07.14	78/93/100/107/ 125/150		JBH, TW	F 026 003 140	25,4	
					TW	0 204 123 775	25,4	
	40 C 14 CNG, 15	01.12-07.14	100/107			0 204 123 773	28,57	
	50 C 15, 17	07.11-07.14	107/125			0 204 123 773	28,57	
	65 C 14 CNG, 15, 17, 21	07.11-07.14	100/107/ 125/150		TW	0 204 123 732	31,75	
						0 204 123 733	31,75	
	70 C 14 CNG, 15, 17, 21	07.11-07.14	100/107/ 125/150		TW	0 204 123 732	31,75	
						0 204 123 733	31,75	
	29 L 11, 13, 15	07.11-07.14	78/93/146		TW	0 204 125 828		
						0 204 125 910		
	35 C 11, 13, 14 CNG, 15, 17, 21	07.11-07.14	78/93/100/107/ 125/150		TW	0 204 125 828		
						0 204 125 910		
	35 S 11, 13, 14 CNG, 15, 17, 21	07.11-07.14	78/93/100/107/ 125/150		TW	0 204 125 828		
						0 204 125 910		
	40 C 11, 13, 14 CNG, 15, 17, 21	01.12-07.14	78/93/100/ 107/125/ 150		TW	0 204 125 899		
					TW	0 204 051 629 ^S		
				Fg.-Nr. →5552507, →D278216	TW	0 204 051 360 ^S		
				Fg.-Nr. 5552508→, D278217→	TW	0 204 051 361 ^S		
	50 C 14 CNG	07.11-07.14	100/107/ 125/150			0 204 125 899		
	50 C 15				TW	0 204 051 629 ^S		
	50 C 17				TW	0 204 051 360 ^S		
	50 C 21				TW	0 204 051 361 ^S		
				Fg.-Nr. →5552507, →D278216				
				Fg.-Nr. 5552508→, D278217→	TW	0 204 051 361 ^S		
	55 S 17	07.11-07.14	125			0 204 051 360 ^S		

		S							
IVECO Daily [12]									
	65 C 14 CNG, 15, 17, 21	07.11-07.14	100/107/125/150				0 204 125 899		
	70 C 14 CNG, 15, 17, 21	07.11-07.14	100/107/125/150				0 204 125 899		
	29 L 11, 13, 15	07.11-07.14	78/93/146				0 204 131 380		
	35 C 11, 13, 14 CNG, 15, 17, 21	07.11-07.14	78/93/100/107/125/150				0 204 131 380		
	35 S 11, 13, 14 CNG, 15, 17, 21	07.11-07.14	78/93/100/107/125/150				0 204 131 380		
	29 L 11, 13, 15	07.11-07.14	78/93/146				0 265 242 259 ^T		
	35 S 11, 13, 14 CNG, 15, 17, 21	07.11-07.14	78/93/100/107/125/150				0 265 242 259 ^T		
	55 S 17	07.11-07.14	125			CS2	0 265 216 845 ^B		
Daily [14]									
	33 S 11, 13, 15	05.14→	78/93/107				0 204 123 775	25,4	
	35 C 11, 13, 14 CNG, 15, 17, 21	05.14→	78/93/100/107/125/150				0 204 123 775	25,4	
	35 S 11, 13, 14 CNG, 15, 17, 21	05.14→	78/93/100/107/125/150				0 204 123 775	25,4	
	40 C 15	05.14→	107				0 204 123 773	28,57	
						TW	0 204 123 773	28,57	
							0 204 123 775	25,4	
	40 C 17, 21	05.14→	125/150				0 204 123 773	28,57	
	50 C 14 CNG, 15, 17, 21	05.14→	100/107/125/150				0 204 123 773	28,57	
	65 C 14 CNG, 15, 17, 21	05.14→	100/107/125/150				0 204 123 733	31,75	
	70 C 14 CNG, 15	05.14→	100/107				0 204 123 733	31,75	
	70 C 17	05.14→	125				0 204 123 732	31,75	
							0 204 123 733	31,75	
	70 C 21	05.14→	150				0 204 123 733	31,75	
	33 S 11, 13, 15	05.14→	78/93/107				0 204 125 910		
	35 C 11, 13, 14 CNG, 15, 17, 21	05.14→	78/93/100/107/125/150				0 204 125 910		
	35 S 11, 13, 14 CNG, 15, 17, 21	05.14→	78/93/100/107/125/150				0 204 125 910		
	40 C 15	05.14→	107				0 204 051 629 ^S		
							0 204 125 899		
						TW	0 204 051 629 ^S		
							0 204 125 899		
							0 204 125 910		
	40 C 17	05.14→	125/150				0 204 051 629 ^S		
	40 C 21						0 204 125 899		
	50 C 14 CNG, 15, 17, 21	05.14→	100/107/ 125/150				0 204 051 629 ^S		
							0 204 125 899		
	65 C 14 CNG, 15, 17, 21	05.14→	100/107/125/150				0 204 125 899		
	70 C 14 CNG, 15, 17, 21	05.14→	100/107/125/150				0 204 125 899		
Daily [96]									
	59 -12 Turbo	05.96-05.99	90				0 204 125 430		
Scudato									
	35 .10	01.99-12.03	76			JBH	F 026 003 140	25,4	
	60 .13	10.05-12.11	92				0 204 123 413		
	35 .10	01.99-12.03	76				0 204 125 266		
	60 .13	10.05-12.11	92				0 204 125 519		



JAGUAR

XJ 12



	5.3 HE	01.90-09.94	183-207			0 265 200 056 ^H	
--	--------	-------------	---------	--	--	----------------------------	--

	5.3 HE	01.90-09.94	183-207			0 265 105 032 ^H	
--	--------	-------------	---------	--	--	----------------------------	--

X-Type



	2.0	03.02-06.10	96/115	Fg.-Nr. →J12991		0 204 123 591	23,8
	2.0 D			Fg.-Nr. J12992→		0 204 123 785	23,81
	2.2 D	09.05-11.09	107-114	Fg.-Nr. →J12991		0 204 123 591	23,8
				Fg.-Nr. J12992→		0 204 123 785	23,81
	2.5	03.01-11.09	144	Fg.-Nr. →J12991		0 204 123 591	23,8
				Fg.-Nr. J12992→		0 204 123 785	23,81
	3.0	03.01-11.09	169-172	Fg.-Nr. →J12991		0 204 123 591	23,8
				Fg.-Nr. J12992→		0 204 123 785	23,81

	2.0, D	03.02-06.10	96/115	Fg.-Nr. →J12991	RLE	0 204 125 790	
				Fg.-Nr. J12992→	LLE	0 204 125 896	
					RLE	0 204 125 895	
	2.2 D	09.05-11.09	107-114	Fg.-Nr. →J12991	RLE	0 204 125 790	
				Fg.-Nr. J12992→	LLE	0 204 125 896	
					RLE	0 204 125 895	
	2.5	03.01-11.09	144	Fg.-Nr. →J12991	RLE	0 204 125 790	
				Fg.-Nr. J12992→	LLE	0 204 125 896	
					RLE	0 204 125 895	
	3.0	03.01-11.09	169-172	Fg.-Nr. →J12991	RLE	0 204 125 790	
				Fg.-Nr. J12992→	LLE	0 204 125 896	
					RLE	0 204 125 895	

	2.2 D	09.05-11.09	107-114			0 986 486 610	31
--	-------	-------------	---------	--	--	---------------	----

	2.0	03.02-06.10	96/115	Fg.-Nr. →J12991		0 265 224 047 ^F	
	2.0 D			Fg.-Nr. J12992→		0 265 235 019 ^T	
	2.2 D	09.05-11.09	107-114	Fg.-Nr. →J12991		0 265 224 047 ^F	
				Fg.-Nr. J12992→		0 265 235 019 ^T	
	2.5	03.01-11.09	144	Fg.-Nr. →D55321		0 265 225 068 ^T	
				Fg.-Nr. →J12991		0 265 222 022 ^H	
				Fg.-Nr. J12992→		0 265 235 019 ^T	
	3.0	03.01-11.09	169-172	Fg.-Nr. →D55321		0 265 225 068 ^T	
				Fg.-Nr. →J12991		0 265 222 022 ^H	

X-Type Estate



	2.0	03.03-10.05	96/115	Fg.-Nr. →J12991		0 204 123 591	23,8
	2.0 D			Fg.-Nr. J12992→		0 204 123 785	23,81
	2.2 D	09.05-12.09	107-114	Fg.-Nr. →J12991		0 204 123 591	23,8
				Fg.-Nr. J12992→		0 204 123 785	23,81
	2.5	09.03-12.09	144	Fg.-Nr. →J12991		0 204 123 591	23,8
				Fg.-Nr. J12992→		0 204 123 785	23,81
	3.0	09.03-12.09	169-172	Fg.-Nr. →J12991		0 204 123 591	23,8
				Fg.-Nr. J12992→		0 204 123 785	23,81



◀ JAGUAR X-Type Estate						
	2.0	03.03-10.05	96/115	Fg.-Nr. →J12991	RLE	0 204 125 790
	2.0D			Fg.-Nr. J12992→	LLE	0 204 125 896
					RLE	0 204 125 895
	2.2D	09.05-12.09	107-114	Fg.-Nr. →J12991	RLE	0 204 125 790
				Fg.-Nr. J12992→	LLE	0 204 125 896
					RLE	0 204 125 895
	2.5	09.03-12.09	144	Fg.-Nr. →J12991	RLE	0 204 125 790
				Fg.-Nr. J12992→	LLE	0 204 125 896
					RLE	0 204 125 895
	3.0	09.03-12.09	169-172	Fg.-Nr. →J12991	RLE	0 204 125 790
				Fg.-Nr. J12992→	LLE	0 204 125 896
					RLE	0 204 125 895
	2.2D	09.05-12.09	107-114			0 986 486 610
						31
	2.0	03.03-10.05	96/115	Fg.-Nr. →J12991		0 265 224 047 ^F
	2.0D			Fg.-Nr. J12992→		0 265 235 019 ^F
	2.2D	09.05-12.09	107-114	Fg.-Nr. →J12991		0 265 224 047 ^F
				Fg.-Nr. J12992→		0 265 235 019 ^F
	2.5	09.03-12.09	144	Fg.-Nr. →D55321		0 265 225 068 ^F
				Fg.-Nr. →J12991		0 265 222 022 ^H
				Fg.-Nr. J12992→		0 265 235 019 ^F
	3.0	09.03-12.09	169-172	Fg.-Nr. →D55321		0 265 225 068 ^F
				Fg.-Nr. →J12991		0 265 222 022 ^H

JEEP

Cherokee



	2.5 i	01.95-07.04	78/85		JBH	0 986 480 958	25,4
--	-------	-------------	-------	--	-----	---------------	------

Cherokee [XJ]



	2.5 D Turbo	10.95-12.01	85-89		JBH	0 986 480 958	25,4
	2.5 i 4x4	09.90-09.01	90		JBH	0 986 480 958	25,4
	4.0	09.93-08.01	127-131		JBH	0 986 480 958	25,4

Grand Cherokee [ZG]



	2.5 TD	01.97-04.99	85-87		JBH	0 986 480 958	25,4
	4.0 i	01.97-04.99	130-135		JBH	0 986 480 958	25,4
	5.2 i	01.97-04.99	156		JBH	0 986 480 958	25,4
	5.9 i	01.97-04.99	177		JBH	0 986 480 958	25,4

Grand Cherokee [ZJ]



	4.0, 4x4	01.95-08.98	135-145		JBH	0 986 480 958	25,4
	5.2, 4x4	01.95-09.98	156/164		JBH	0 986 480 958	25,4
	5.9, 4x4	10.96-09.98	177/183		JBH	0 986 480 958	25,4

Renegade



	1.4	07.14→	103/125		LLE	0 204 824 666	
	1.4 4x4				RLE	0 204 123 824	23,81

		S							
1.6		07.14→	81/88			LLE	0 204 824 666		
1.6 CRD						RLE	0 204 123 824	23,81	
2.0 CRD 4x4		07.14→	88/103/125			LLE	0 204 824 666		
						RLE	0 204 123 824	23,81	
2.4 4x4		07.14→	137			LLE	0 204 824 666		
						RLE	0 204 123 824	23,81	
1.4		07.14→	103/125			LLE	0 204 824 665		
1.4 4x4						RLE	0 204 125 950		
1.6		07.14→	81/88			LLE	0 204 824 665		
1.6 CRD						RLE	0 204 125 950		
2.0 CRD 4x4		07.14→	88/103/125			LLE	0 204 824 665		
						RLE	0 204 125 950		
2.4 4x4		07.14→	137			LLE	0 204 824 665		
						RLE	0 204 125 950		

KIA

Carens [FC]



2.0 CRDi VGT		09.05-08.06	103				F 026 A06 948		
--------------	--	-------------	-----	--	--	--	---------------	--	--

Carens [FG]



1.6, CRDi		02.09→	85/91-97				F 026 A09 571		
2.0 CRDi		09.06-08.10	85/100		MG5		F 026 A06 948		

Carens [RP]



1.6 GDI		01.13→	99				F 026 A09 571		
1.7 CRDi		01.13→	85				F 026 A09 571		
2.0 GDI		01.13→	122				F 026 A09 571		

Carnival [MB]



2.7 V6		04.06-07.09	139				0 265 231 635 ^B		
							0 265 235 220 ^T		
2.9 CRDi		04.06-07.09	136				0 265 231 635 ^B		
							0 265 235 220 ^T		
3.8 i		07.06→	182				0 265 231 635 ^B		
							0 265 235 220 ^T		

Cee'd [ED/FF2]



1.4		11.08-12.12	66/77/80				F 026 A09 571		
1.6, CRDi		11.08-12.12	85-93/94				F 026 A09 571		
1.6 CRDi		03.09-12.12	66/85				F 026 A09 571		
2.0		11.08-12.12	105				F 026 A09 571		

Cee'd [JD]



1.4, CRDi		05.12→	66/73				F 026 A09 571		
1.6 CRDi, GDi		05.12→	81/94/99				F 026 A09 571		



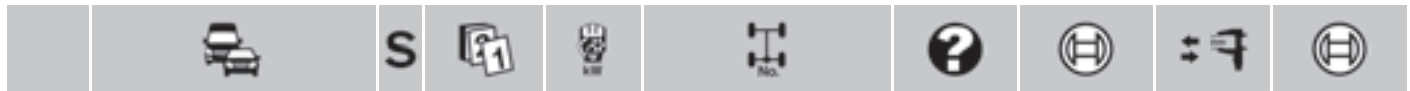

◀ KIA

Cee'd Sporty Wagon [ED/FF2]



	1.4	11.08-12.12	66/77/80	F 026 A09 571
	1.6, CRDi	11.08-12.12	85-93/94	F 026 A09 571
	1.6 CRDi	03.09-12.12	66/85	F 026 A09 571
	2.0	11.08-12.12	105	F 026 A09 571

Cee'd Sporty Wagon [JD]



	1.4	08.12→	66/73	F 026 A09 571
	1.6	08.12→	81/94/99	F 026 A09 571

Cerato [FE]



	1.6 i	10.04-11.09	77	F 026 A06 948
	2.0 CRDi	03.04-11.09	83	F 026 A06 948

Cerato Hatchback [FE]



	1.6 i	03.04-11.09	77	F 026 A06 948
	2.0 CRDi	03.04-11.09	83	F 026 A06 948

Cerato Koup [TD]



	1.6	08.10→	93	F 026 A09 571
--	-----	--------	----	----------------------

Cerato [TD]



	2.0	12.08→	110	F 026 A09 571
--	-----	--------	-----	----------------------

Creto Koup [TD]



	2.0	08.10→	110	F 026 A09 571
--	-----	--------	-----	----------------------

Creto [TD]





























	1.6	08.10→	93	F 026 A09 571
--	-----	--------	----	----------------------

K 2500



	TCi	09.01-06.04	69-96	F 026 A09 399
--	-----	-------------	-------	----------------------



		S							
K 2700									
									
		08.04-12.06	59				F 026 A09 640		
K 2700 [SD]									
									
		04.98-08.04	59				F 026 A09 399		
Magentis [GD]									
									
	2.5 i	09.00-12.05	124				F 026 A06 948		
	2.0 i	01.02-12.05	100				0 265 216 877^B		
	2.5 i	01.02-12.05	124				0 265 216 877^B		
							0 265 220 655^F		
Magentis [GE]									
									
	2.0	02.06-04.10	106/121				F 026 A06 948		
	2.0 i								
Mentor II [FX]									
									
	1.8 i	01.02-08.04	82				F 026 A02 573		
Mentor II Hatchback [FX]									
									
	1.8 i	01.02-08.04	82				F 026 A02 573		
Optima									
									
	2.5 i	07.00-04.02	131				0 265 216 877^B		
Optima [TF]									
									
	2.0	03.12→	121-125				F 026 A09 571		
Pro Cee'd [ED]									
									
	1.4	11.08-12.12	66/77/80				F 026 A09 571		
	1.6 CRDi	11.08-12.12	85-93/94				F 026 A09 571		
	1.6 CRDi	03.09-12.12	66/85				F 026 A09 571		
	2.0	11.08-12.12	105				F 026 A09 571		





◀ KIA

Pro Cee'd [JD]



	1.4, CRDi	01.13→	66/73		F 026 A09 571
	1.6 CRDi, GDI	01.13→	81/94/99		F 026 A09 571

Rio Hatchback [JB, DE]



	1.4, i	03.05-09.11	55/71	LLE	F 026 A09 609
	1.6 i	03.05-09.11	82	LLE	F 026 A09 609

	1.4, i	03.05-09.11	55/71		F 026 A09 571
	1.5 CRDi	03.05-09.11	65/81		F 026 A09 571
	1.6 i	03.05-09.11	82		F 026 A09 571

Rio Hatchback [UB]



	1.1 CRDi	06.11→	55		F 026 A09 571
	1.4, CRDi	06.11→	66/79/80		F 026 A09 571
	1.6	01.12→	91		F 026 A09 571

Rio [JB, DE]



	1.4 i	03.05-09.11	71	LLE	F 026 A09 609
	1.6 i	03.05→	82	LLE	F 026 A09 609

	1.4 i	03.05-09.11	71		F 026 A09 571
	1.5 CRDi	03.05-09.11	65/81		F 026 A09 571
	1.6 i	03.05→	82		F 026 A09 571

Rio [UB]



	1.4	11.11→	79/80		F 026 A09 571
	1.6	01.12→	91		F 026 A09 571

Sorento [JC]



	2.4 i	03.03-04.06	102		0 265 216 929^B
	2.5 CRDi	07.02-04.06	103		0 265 216 929^B
	3.5 i	03.03-08.09	144		0 265 216 929^B

























	2.4 i	03.03-04.06	102		0 265 005 142
	2.5 CRDi	07.02-08.09	103/125		0 265 005 142
	3.3 i	12.06-08.09	177-182		0 265 005 142
	3.5 i	03.03-08.09	144		0 265 005 142



























Spectra Hatchback





















	1.8 i 16V	01.02-12.06	93		F 026 A02 573
--	-----------	-------------	----	--	----------------------

























		S							
Sportage [JE]									
									
	2.0, CRDi, CRDi 4x4, 4x4	01.06-05.10	100-103/ 104/110				F 026 A06 948		
Sportage [SL]									
									
	1.6 GDI	07.10→	99				F 026 A09 571		
	1.7 CRDi	09.10→	85				F 026 A09 571		
	2.0, 4x4	07.10→	120				F 026 A06 948		
	2.0 GDI, GDI 4X4	03.14→	122				F 026 A09 571		
LADA									
Forma									
									
	1.3	09.91-12.00	45		JBH		0 986 480 862	20,6	
	1.5	09.91-12.00	53		JBH		0 986 480 862	20,6	
Kalina									
									
	1.4	07.07→	65,5				0 265 231 775^B		
	1.6	11.04→	59,5/62/65,5				0 265 231 775^B		
Kalina Hatchback									
									
	1.4	07.07→	65,5				0 265 231 775^B		
	1.6	07.06→	59,5/62				0 265 231 775^B		
Kalina Kombi									
									
	1.4	07.07→	65,5				0 265 231 775^B		
	1.6	07.07→	59,5/62				0 265 231 775^B		
Niva									
									
	1.9 TD	07.99→	55		JBH		0 986 480 862	20,6	
	1.9 TD	07.99→	55		RLE		0 986 486 000	19,05	
Priora									
									
	1.6 16V	11.06→	72				0 265 231 775^B		
	1.8	03.08→	88				0 265 231 775^B		

		S				?			
◀ LADA									
Priora Hatchback									
									
	1.6 16V	01.08→	72				0 265 231 775 ^B		
	1.8	03.08→	88				0 265 231 775 ^B		
Priora Kombi									
									
	1.6	01.08→	72				0 265 231 775 ^B		
Samara									
									
	1.1 i	09.91-12.00	39		JBH		0 986 480 862	20,6	
	1.3 i	02.96→	50		JBH		0 986 480 862	20,6	
	1.5 D, i	01.84→	40-42/50/57/60		JBH		0 986 480 862	20,6	
Samara Fun									
									
	1.1	09.88→	39		JBH		0 986 480 862	20,6	
	1.3	09.88→	45-48		JBH		0 986 480 862	20,6	
	1.5	09.88→	50-53		JBH		0 986 480 862	20,6	
Samara Hatchback									
									
	1.1	01.84→	39/43		JBH		0 986 480 862	20,6	
	1.3, i	01.84→	48		JBH		0 986 480 862	20,6	
	1.5, i	01.84→	52/55/57		JBH		0 986 480 862	20,6	
Serie 110									
									
	1.5, i 8V, i 16V, 16V Premier	01.96-12.04	54/56/57/58/68/69		JBH		0 986 480 862	20,6	
	1.6 i, i 8V, i 16V	01.05→	59/65,5		JBH		0 986 480 862	20,6	
	2.0 GTI	01.96-12.00	110				0 273 004 181 ^H		
	2.0 16V								
Serie 111									
									
	1.5, i, i 8V, i 16V	01.96-12.04	56/57-58/68/69/70		JBH		0 986 480 862	20,6	
	1.6 i	01.05→	59		JBH		0 986 480 862	20,6	
Serie 112									
									
	1.5 i, i 8V, i 16V	01.96→	54/56/56,4/58/66/67/69		JBH		0 986 480 862	20,6	
	1.6 i	01.05→	59		JBH		0 986 480 862	20,6	
Serie 115									
									
	1.3, i	01.98→	47		JBH		0 986 480 862	20,6	
	1.5, i	01.98→	52/57		JBH		0 986 480 862	20,6	



		S							
Serie 2100									
									
	2106 1.6	09.75→	55			JBH,RLE	0 986 481 019		19,05
	2107-02 1.5	01.86→	52			JBH,RLE	0 986 481 019		19,05
	2106 1.6	09.75→	55				0 986 486 000		19,05
	2107-02 1.5	01.86→	52				0 986 486 000		19,05
Serie 21000									
									
	21041-30 1.6i	11.07→	54,5			JBH	F 026 003 943		19,05
	210540 1.6i	12.05→	53,5			JBH	F 026 003 943		19,05
	21061 1.5	01.82→	48			JBH,RLE	0 986 481 019		19,05
	21063 1.3	01.86→	48			JBH,RLE	0 986 481 019		19,05
	21072 1.3	02.86→	48			JBH,RLE	0 986 481 019		19,05
	21073-40 1.7	01.86→				JBH,RLE	0 986 481 019		19,05
	210740 1.6i	12.05→	53,5			JBH	F 026 003 943		19,05
	21074 1.6	05.82→	55			JBH,RLE	0 986 481 019		19,05
	21077 1.3	01.86-12.00	48			JBH,RLE	0 986 481 019		19,05
	21099 1.5i	01.90-01.04	56,4			JBH	0 986 480 862		20,6
	21041-30 1.6i	11.07→	54,5				0 986 486 000		19,05
	210540 1.6i	12.05→	53,5				0 986 486 000		19,05
	21061 1.5	01.82→	48				0 986 486 000		19,05
	21063 1.3	01.86→	48				0 986 486 000		19,05
	21072 1.3	02.86→	48				0 986 486 000		19,05
	21073-40 1.7	01.86→					0 986 486 000		19,05
	210740 1.6i	12.05→	53,5				0 986 486 000		19,05
	21074 1.6	05.82→	55				0 986 486 000		19,05
	21077 1.3	01.86-12.00	48				0 986 486 000		19,05
Toscana									
									
	1.4	01.86-12.00	55			JBH,RLE	0 986 481 019		19,05
	1.5	01.86-12.00	55			JBH,RLE	0 986 481 019		19,05
	1.4	01.86-12.00	55				0 986 486 000		19,05
	1.5	01.86-12.00	55				0 986 486 000		19,05
LANCIA									
Dedra Berlina [835]									
									
	1.6 i	03.93-10.94	55/65			RLE	0 204 122 268		22,22
		ABO 04.93-10.94	55			JBH	F 026 003 528		22,2
		ABS 04.93-10.94	55				0 204 122 261		19
	1.6 i, i 16V	10.94-10.99	66/76			JBH	F 026 003 528		22,2
	1.8 i	03.93-10.94	77			GS,JBH	F 026 003 528		22,2
		10.94-12.95	74			JBH	F 026 003 528		22,2
	1.8 i 16V	01.96-10.99	83/97			JBH	F 026 003 528		22,2
	1.9 TD	10.94-10.99	66			JBH	F 026 003 528		22,2
		ABO 01.89-10.94	66			JBH	F 026 003 243		20,6
		ABS 01.89-10.94	66				0 204 122 261		19
	2.0 i	03.93-10.94	83			RLE	0 204 122 268		22,22
		ABO 09.89-10.94	83			AG	0 204 122 261		19
						GS,JBH	F 026 003 243		20,6

		S							
	◀ LANCIA Dedra Berlina [835]								
	2.0 i	ABS	09.89-10.94	83		JBH	F 026 003 528	22,2	
	2.0 i Automatic		10.94-10.99	83		JBH	F 026 003 528	22,2	
	2.0 i 16V		10.94-10.99	102		JBH	F 026 003 528	22,2	
	1.6 i		01.89-10.94	55/65	Ricam.Nr →4014222	LLE	0 204 125 732		
			03.93-10.94	55/65		AG	0 204 125 601 ^S		
						AG,LLE	0 204 125 436		
						GS	0 204 125 443 ^S		
						GS,LLE	0 204 125 724		
			10.94-04.98	66			0 204 125 436		
							0 204 125 601 ^S		
	1.6 i 16V		04.98-10.99	76			0 204 125 436		
	1.8 i		09.89-10.94	77	Ricam.Nr →4014222	LLE	0 204 125 732		
			03.93-10.94	77		AG	0 204 125 601 ^S		
						AG,LLE	0 204 125 436		
						GS	0 204 125 443 ^S		
						GS,LLE	0 204 125 724		
			10.94-12.95	74			0 204 125 436		
							0 204 125 601 ^S		
	1.8 i 16V		01.96-10.99	83			0 204 125 436		
							0 204 125 601 ^S		
				97			0 204 125 436		
	1.9 TD		01.89-10.94	66			0 204 125 732		
			01.89-10.99	66			0 204 125 601 ^S		
			10.94-10.99	66			0 204 125 436		
	2.0 i		09.89-10.94	83	Ricam.Nr →4014222	LLE	0 204 125 732		
			03.93-10.94	83		AG	0 204 125 601 ^S		
						AG,LLE	0 204 125 436		
						GS	0 204 125 443 ^S		
						GS,LLE	0 204 125 724		
	2.0 i Automatic		10.94-10.99	83			0 204 125 436		
							0 204 125 601 ^S		
	2.0 i 16V		10.94-10.99	102			0 204 125 436		
	1.8 i 16V		01.96-10.99	83/97			F 026 005 095	19	
	1.9 TD		10.94-10.99	66			F 026 005 095	19	
	2.0 i		11.90-10.94	119/121	Ricam.Nr 4008264→	LLE	F 026 005 095	19	
	2.0 i 4x4 Integrale		12.90-10.94	119/121		RLE	0 204 162 088		
	2.0 i 16V		10.94-10.99	102			F 026 005 095	19	
	1.8 i 16V		01.96-10.99	97			F 026 005 581	25,4	
	2.0 i 16V		05.95-10.99	102			F 026 005 581	25,4	
	1.6 i, i 16V		01.89-10.99	55/65/66/76			0 204 131 221		
	1.8 i, i 16V		09.89-10.99	74/77/83/97			0 204 131 221		
	1.9 TD		01.89-10.99	66			0 204 131 221		
	2.0 i, i Automatic, i 4x4 Integrale, i 16V		09.89-10.99	83/102/119/121			0 204 131 221		
	1.6 i		03.93-10.94	55/65			0 265 201 054 ^H		
	1.6 i, i 16V		10.94-10.99	66/76			0 265 216 425 ^B		
	1.8 i		03.93-10.94	77			0 265 201 054 ^H		
			10.94-12.95	74			0 265 216 425 ^B		
	1.8 i 16V		01.96-10.99	83/97			0 265 216 425 ^B		
	1.9 TD		01.89-10.94	66			0 265 201 024 ^H		
			10.94-10.99	66			0 265 216 425 ^B		
	2.0 i		09.89-10.94	83			0 265 201 024 ^H		
			12.91-10.94	119			0 265 208 034 ^B		
	2.0 i Automatic		10.94-10.99	83			0 265 216 425 ^B		
	2.0 i 4x4 Integrale		04.91-10.94	121			0 265 201 016 ^H		
	2.0 i 16V		10.94-10.95	102	Ricam.Nr →4109547		0 265 208 034 ^B		
			11.95-10.99	102	Ricam.Nr 4109548→		0 265 216 425 ^B		

									
	1.6 i	03.93-10.94	55/65				0 265 100 042^H		
	1.8 i	03.93-10.94	77				0 265 100 042^H		
	1.9 TD	01.89-10.94	66				0 265 100 042^H		
	2.0 i	09.89-10.94	83				0 265 100 042^H		
	2.0 i 4x4 Integrale	04.91-10.94	121				0 265 105 035^H		
Dedra Station Wagon [835]									
									
	1.6 i, i 16V	10.94-10.99	66/76			JBH	F 026 003 528	22,2	
	1.8 i, i 16V	10.94-10.99	74/83/97			JBH	F 026 003 528	22,2	
	1.9 TD	10.94-10.99	66			JBH	F 026 003 528	22,2	
	2.0 i 16V	10.94-10.99	102			JBH	F 026 003 528	22,2	
	2.0 i 16V 4x4	ABO 10.94-10.99	102			JBH	F 026 003 528	22,2	
	1.6 i, i 16V	10.94-10.99	66/76				0 204 125 436		
	1.8 i	10.94-10.99	74/83				0 204 125 436		
	1.8 i 16V						0 204 125 601^S		
	1.8 i 16V	01.96-10.99	97				0 204 125 436		
	1.9 TD	10.94-10.99	66				0 204 125 436		
							0 204 125 601^S		
	2.0 i 16V	10.94-10.99	102				0 204 125 436		
	2.0 i 16V 4x4	ABO 10.94-10.99	102				0 204 125 436		
		ABS 10.94-10.99	102				0 204 125 431^S		
	1.8 i 16V	01.96-10.99	83/97				F 026 005 095	19	
	1.9 TD	10.94-10.99	66				F 026 005 095	19	
	2.0 i 16V, i 16V 4x4	10.94-10.99	102				F 026 005 095	19	
	1.8 i 16V	01.96-10.99	97				F 026 005 581	25,4	
	2.0 i 16V, i 16V 4x4	05.95-10.99	102				F 026 005 581	25,4	
	1.6 i, i 16V	10.94-10.99	66/76				0 204 131 221		
	1.8 i, i 16V	10.94-10.99	74/83/97				0 204 131 221		
	1.9 TD	10.94-10.99	66				0 204 131 221		
	2.0 i 16V, i 16V 4x4	10.94-10.99	102				0 204 131 221		
	1.6 i, i 16V	10.94-10.99	66/76				0 265 216 425^B		
	1.8 i, i 16V	10.94-10.99	74/83/97				0 265 216 425^B		
	1.9 TD	10.94-10.99	66				0 265 216 425^B		
	2.0 i 16V	10.94-10.95	102			Ricam.Nr →4109547	0 265 208 034^B		
		11.95-10.99	102			Ricam.Nr 4109548→	0 265 216 425^B		
Delta [831]									
									
	2.0 i Turbo 8V Int. 4x4	03.89-01.94	126/158				0 204 162 083		
	2.0 i Turbo 16V Int. 4x4								
	2.0 i Turbo 8V Int. 4x4	03.89-01.94	126/158				F 026 005 580	25,4	
	2.0 i Turbo 16V Int. 4x4								
	2.0 i Turbo 8V Int. 4x4	03.89-01.94	126/158				0 204 131 212		
	2.0 i Turbo 16V Int. 4x4								
	2.0 i Turbo 8V Int. 4x4	03.89-01.94	126/158				0 265 201 033^H		
	2.0 i Turbo 16V Int. 4x4								
	2.0 i Turbo 8V Int. 4x4	03.89-01.94	126/158				0 265 105 035^H		
	2.0 i Turbo 16V Int. 4x4								

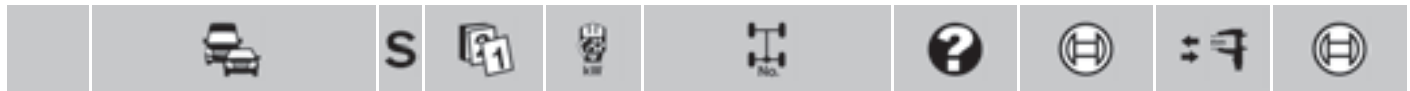

◀ LANCIA

Delta [836]



















	1.4 i	06.93-12.99	51	JBH	F 026 003 528	22,2
	1.6 i, i 16V HPE	06.93-12.99	55/66/76	JBH	F 026 003 528	22,2
	1.8 i, i GT 16V, i 16V	06.93-12.99	66/74/76/83/97	JBH	F 026 003 528	22,2
	1.9 TD	07.94-12.99	66	JBH	F 026 003 528	22,2
	2.0 i 16V, i 16V Turbo HPE	06.93-12.99	102/137	JBH	F 026 003 528	22,2
	1.4 i	06.93-12.99	51		0 204 125 436	
					0 204 125 601^S	
	1.6 i	06.93-12.99	55/66/76		0 204 125 436	
	1.6 i 16V HPE				0 204 125 601^S	
	1.8 i, i GT 16V, i 16V	06.93-12.99	66/74/76/ 83/97		0 204 125 436	
					0 204 125 601^S	
	1.9 TD	07.94-12.99	66		0 204 125 436	
					0 204 125 601^S	
	1.8 i 16V	01.96-12.99	83		F 026 005 095	19
	2.0 i 16V, i 16V Turbo HPE	06.93-12.99	102/137		F 026 005 095	19
	1.8 i 16V	01.96-12.99	83		F 026 005 581	25,4
	2.0 i 16V	05.95-12.95	102		F 026 005 581	25,4
	2.0 i 16V Turbo HPE	05.95-12.99	137		0 204 163 077	
	1.4 i	06.93-12.99	51		0 204 131 221	
	1.6 i, i 16V HPE	06.93-12.99	55/66/76		0 204 131 221	
	1.8 i, i GT 16V, i 16V	06.93-12.99	66/74/76/83/97		0 204 131 221	
	1.9 TD	07.94-12.99	66		0 204 131 221	
	2.0 i 16V, i 16V Turbo HPE	06.93-12.99	102/137		0 204 131 221	
	1.4 i	06.93-12.99	51		0 265 208 034^B	
	1.6 i	06.93-12.99	55		0 265 208 034^B	
	1.6 i 16V HPE	01.96-12.99	66/76		0 265 216 425^B	
	1.8 i	06.93-12.99	66/74/76		0 265 208 034^B	
	1.8 i GT 16V, i 16V	01.96-12.99	83/97		0 265 216 425^B	
	1.9 TD	07.94-08.96	66		0 265 208 034^B	
		09.96-12.99	66		0 265 216 425^B	
	2.0 i 16V, i 16V Turbo HPE	06.93-12.99	102/137		0 265 208 034^B	

Delta [844]



	1.4 i BiFuel	12.09→	88	HAG	0 204 123 765	23,81
	1.4 i BiFuel, i 16V	11.08→	88	GS	0 204 123 792	23,81
	1.4 i 16V	07.08-10.08	88	GS	0 204 123 766	23,81
			110	GS	0 204 123 766	23,81
		07.08-07.10	110	HAG	0 204 123 765	23,81
		07.08→	88	HAG	0 204 123 765	23,81
		11.08-07.10	110	GS	0 204 123 792	23,81
		08.10→	103		0 204 123 792	23,81
	1.6 Multijet	07.08-10.08	88	GS	0 204 123 766	23,81
		07.08-06.13	77/85		0 204 123 792	23,81
		07.08→	88	HAG	0 204 123 765	23,81
		11.08→	88	GS	0 204 123 792	23,81
		07.13→	77/85		0 204 123 766	23,81
1.8 TBi	05.09-12.14	147		0 204 123 765	23,81	
1.9 Multijet	08.08-10.08	140	GS	0 204 123 766	23,81	
	08.08→	140	HAG	0 204 123 765	23,81	
	11.08→	140	GS	0 204 123 792	23,81	

		S							
2.0 Multijet		08.08-10.08	121			GS	0 204 123 766	23,81	
		08.08-06.13	120				0 204 123 792	23,81	
		08.08→	121			HAG	0 204 123 765	23,81	
		11.08→	121			GS	0 204 123 792	23,81	
		07.13→	120				0 204 123 766	23,81	
	1.4 i BiFuel, i 16V	07.08→	88/103/110				0 204 125 906		
	1.6 Multijet	07.08-06.13	77/85				0 204 125 905		
		07.08→	88				0 204 125 905		
		07.13→	77/85				0 204 808 616		
	1.8 TBi	05.09-12.14	147				0 204 125 905		
1.9 Multijet	08.08→	140				0 204 125 905			
2.0 Multijet	08.08→	120/121				0 204 125 905			
Kappa Berlina [838]									
									
	2.0 i Turbo 16V, i 20V	11.94-12.00	110/114/151			JBH	0 986 480 687	23,8	
	2.4 i 20V, JTD, TD	11.94-12.00	91/100/129			JBH	0 986 480 687	23,8	
	3.0 i 24V	11.94-06.98	150			JBH	0 986 480 687	23,8	
		06.98-12.00	150	Fg.-Nr. →2084302		JBH	0 986 480 687	23,8	
	2.0 i Turbo 16V, i 20V	11.94-06.98	110/114/151				F 009 D00 768		
	2.4 i 20V, JTD, TD	11.94-12.00	91/100/129				F 009 D00 768		
	3.0 i 24V	11.94-06.98	150				F 009 D00 768		
	2.0 i Turbo 16V, i Turbo 20V, i 20V	11.94-12.00	110/114/151/162				0 204 163 077		
	2.4 i 20V, JTD, TD	11.94-12.00	91/100/129				0 204 163 077		
	3.0 i 24V	11.94-12.00	150				0 204 163 077		
	2.0 i Turbo 16V	11.94-06.98	151	Ricam.Nr →2059703			0 265 216 032 ^B		
				Ricam.Nr 2059704→			0 265 216 453 ^B		
	2.0 i Turbo 20V	06.98-12.00	162				0 265 216 677 ^B		
	2.0 i 20V	11.94-06.96	110	Ricam.Nr →2059703			0 265 216 032 ^B		
				Ricam.Nr 2059704→			0 265 216 453 ^B		
		06.96-06.98	114	Ricam.Nr →2059703			0 265 216 032 ^B		
		06.98-12.00	114	Ricam.Nr 2059704→			0 265 216 453 ^B		
	2.4 i 20V	11.94-06.98	129	Ricam.Nr →2059703			0 265 216 032 ^B		
				Ricam.Nr 2059704→			0 265 216 453 ^B		
		06.98-12.00	129				0 265 216 677 ^B		
	2.4 JTD	03.98-12.00	100				0 265 216 677 ^B		
	2.4 TD	11.94-06.96	91				0 265 216 032 ^B		
		06.96-03.98	91	Ricam.Nr →2059703			0 265 216 032 ^B		
				Ricam.Nr 2059704→			0 265 216 453 ^B		
	3.0 i 24V	11.94-06.98	150				0 265 216 032 ^B		
06.98-12.00		150			GS	0 265 216 677 ^B			
			Fg.-Nr. →2092370			0 265 216 677 ^B			
			Fg.-Nr. 2092371→			0 265 216 743 ^B			
	04.99-12.00	150			AG	0 265 216 743 ^B			
Kappa Coupé [838]									
									
	2.4 i 20V	04.97-06.00	129			JBH	0 986 480 687	23,8	
	3.0 i 24V V6	04.97-06.00	150			JBH	0 986 480 687	23,8	
	2.0 i Turbo 16V, i Turbo 20V	04.97-06.00	151/162				F 009 D00 768		
	2.4 i 20V	04.97-06.00	129				F 009 D00 768		
	3.0 i 24V V6	04.97-06.00	150				F 009 D00 768		



◀ LANCIA Kappa Coupé [838]

	2.0 i Turbo 16V, i Turbo 20V	04.97-06.00	151/162		0 204 163 077		
	2.4 i 20V	04.97-06.00	129		0 204 163 077		
	3.0 i 24V V6	04.97-06.00	150		0 204 163 077		
	2.0 i Turbo 16V, i Turbo 20V	04.97-06.00	151/162		0 204 131 343		
	2.4 i 20V	04.97-06.00	129		0 204 131 343		
	3.0 i 24V V6	04.97-06.00	150		0 204 131 343		
	2.0 i Turbo 16V	04.97-06.98	151		0 265 216 453^B		
	2.0 i Turbo 20V	06.98-06.00	162	GS	0 265 216 677^B		
		04.99-06.00	162	AG	0 265 216 743^B		
	2.4 i 20V	04.97-06.98	129		0 265 216 453^B		
		06.98-06.00	129	GS	0 265 216 677^B		
		04.99-06.00	129	AG	0 265 216 743^B		
	3.0 i 24V V6	04.97-06.00	150	Fg.-Nr. →TEL1002100	GS	0 265 216 453^B	
				Fg.-Nr. TEL1002101→	GS	0 265 216 677^B	
		04.99-06.00	150	AG	0 265 216 743^B		

Kappa Station Wagon [838]



















	2.0 i Turbo 16V, i 20V	11.94-12.00	114/151	JBH	0 986 480 687	23,8
	2.4 D Turbo, i 20V, JTD	11.94-12.00	91/100/129	JBH	0 986 480 687	23,8
	3.0 i 24V	11.94-06.98	150	JBH	0 986 480 687	23,8
	2.0 i Turbo 16V, i 20V	11.94-06.98	114/151		F 009 D00 768	
	2.4 D Turbo, i 20V, JTD	11.94-12.00	91/100/129		F 009 D00 768	
	3.0 i 24V	11.94-06.98	150		F 009 D00 768	
	2.0 i Turbo 16V, i Turbo 20V, i 20V	11.94-12.00	114/151/162		0 204 163 077	
	2.4 D Turbo, i 20V, JTD	11.94-12.00	91/100/129		0 204 163 077	
	3.0 i 24V	11.94-12.00	150		0 204 163 077	
	2.0 i Turbo 16V	11.94-06.98	151	Ricam.Nr →2059703	0 265 216 032^B	
				Ricam.Nr 2059704→	0 265 216 453^B	
	2.0 i Turbo 20V	06.98-12.00	162		0 265 216 677^B	
	2.0 i 20V	06.96-06.98	114	Ricam.Nr →2059703	0 265 216 032^B	
				Ricam.Nr 2059704→	0 265 216 453^B	
		06.98-12.00	114		0 265 216 677^B	
	2.4 D Turbo	06.96-03.98	91	Ricam.Nr →2059703	0 265 216 032^B	
				Ricam.Nr 2059704→	0 265 216 453^B	
	2.4 i 20V	11.94-06.98	129	Ricam.Nr →2059703	0 265 216 032^B	
				Ricam.Nr 2059704→	0 265 216 453^B	
		06.98-12.00	129		0 265 216 677^B	
	2.4 JTD	03.98-12.00	100	GS	0 265 216 677^B	
	3.0 i 24V	11.94-06.98	150		0 265 216 032^B	
				0 265 216 677^B		
06.98-12.00				150	GS	0 265 216 677^B
	04.99-12.00	150	AG	0 265 216 743^B		

























Lybra Berlina [839]



	1.9 JTD	09.00-11.06	80/85	JBH	F 026 003 622	22,2
	1.6 i 16V	10.99-09.05	76		F 026 005 119	19
	1.8 i 16V	10.99-09.05	96		F 026 005 119	19
	1.9 JTD	10.99-11.06	77/80/85		F 026 005 119	19
	2.0 i 20V	10.99-09.05	110/113		F 026 005 119	19
	2.4 i 20V, JTD	10.99-09.05	98/103/110/129		F 026 005 119	19

		S							
	1.6i16V	10.99-09.05	76				F 026 005 581	25,4	
	1.8i16V	10.99-09.05	96				F 026 005 581	25,4	
	1.9JTD	10.99-11.06	77/80/85				0 204 163 077		
	2.0i20V	10.99-09.05	110/113				F 026 005 581	25,4	
	2.4i20V, JTD	10.99-09.05	98/103/110/129				0 204 163 077		
	1.6i16V	10.99-09.00	76				0 265 216 534 ^B		
		10.00-08.01	76	Fg.-Nr. →0110733			0 265 216 534 ^B		
	1.8i16V	10.99-09.00	96				0 265 216 534 ^B		
		09.00-08.01	96	Fg.-Nr. →0110733			0 265 216 534 ^B		
	1.9JTD	10.99-06.01	77/80				0 265 216 534 ^B		
		06.01-08.01	85	Fg.-Nr. →0110733			0 265 216 534 ^B		
	2.0i20V	10.99-09.00	113				0 265 216 534 ^B		
		10.00-09.05	110				0 265 216 534 ^B		
	2.4i20V	10.99-05.02	129				0 265 216 534 ^B		
		10.00-09.05	110				0 265 216 810 ^B		
	2.4JTD	10.99-09.00	98				0 265 216 534 ^B		
	09.00-08.01	103	Fg.-Nr. →0110733			0 265 216 534 ^B			
Lybra Station Wagon [839]									
									
	1.9JTD	09.00-11.06	80/85			JBH	F 026 003 622	22,2	
	1.6i16V	10.99-09.05	76				F 026 005 119	19	
	1.8i16V	10.99-09.05	96				F 026 005 119	19	
	1.9JTD	10.99-11.06	77/80/85				F 026 005 119	19	
	2.0i20V	10.99-09.05	113				F 026 005 119	19	
	2.4JTD	10.99-09.05	98/103/110				F 026 005 119	19	
	1.6i16V	10.99-09.05	76				F 026 005 581	25,4	
	1.8i16V	10.99-09.05	96				F 026 005 581	25,4	
	1.9JTD	10.99-11.06	77/80/85				0 204 163 077		
	2.0i20V	10.99-09.05	113				F 026 005 581	25,4	
	2.4JTD	10.99-09.05	98/103/110				0 204 163 077		
	1.6i16V	10.99-09.00	76				0 265 216 534 ^B		
		10.00-08.01	76	Fg.-Nr. →0110733			0 265 216 534 ^B		
	1.8i16V	10.99-09.00	96				0 265 216 534 ^B		
		09.00-08.01	96	Fg.-Nr. →0110733			0 265 216 534 ^B		
	1.9JTD	10.99-06.01	77/80				0 265 216 534 ^B		
		06.01-08.01	85	Fg.-Nr. →0110733			0 265 216 534 ^B		
	2.0i20V	10.99-09.00	113				0 265 216 534 ^B		
		10.00-09.05	113				0 265 216 534 ^B		
	2.4JTD	10.99-09.00	98				0 265 216 534 ^B		
		09.00-08.01	103	Fg.-Nr. →0110733			0 265 216 534 ^B		
	Musa [350]								
									
	1.3 Multijet	01.07→	51-55/66/70				0 204 705 421	23,8	
		MFD 10.04-12.06	51-55/66			JBH	F 026 003 588	23,81	
		OFD 10.04-12.06	51-55/66			JBH	F 026 003 641	23,81	
	1.4, LPG, 16V	01.07→	55/57/66/70				0 204 705 421	23,8	

		S							
◀ LANCIA Musa [350]									
1.4	MFD	10.04-12.06	55/66/70			JBH	F 026 003 588	23,81	
1.4 16V	OFD	10.04-12.06	55/66/70			JBH	F 026 003 641	23,81	
1.6 Multijet		10.07→	85/88				0 204 705 421	23,8	
1.9 Multijet		01.07→	74				0 204 705 421	23,8	
	MFD	10.04-12.06	74			JBH	F 026 003 588	23,81	
	OFD	10.04-12.06	74			JBH	F 026 003 641	23,81	
1.3 Multijet		10.04-12.06	51-55/66				0 204 125 814		
		01.07-11.10	51-55/66				0 204 125 868		
		03.09→	70				0 204 125 868		
1.4		03.05-12.06	55				0 204 125 814		
		01.07→	55				0 204 125 868		
1.4 LPG		03.09→	57				0 204 125 868		
1.4 16V		10.04-12.06	66/70				0 204 125 814		
		01.07→	66/70				0 204 125 868		
1.6 Multijet		10.07→	85/88				0 204 125 868		
1.9 Multijet		10.04-12.06	74				0 204 125 814		
		01.07→	74				0 204 125 868		
1.3 Multijet		10.04-11.10	51-55				0 986 486 105	15,87	
1.4, 16V		10.04→	55/66/70				0 986 486 105	15,87	
1.6 Multijet		10.07→	85/88				0 986 486 105	15,87	
1.3 Multijet		09.05-11.10	66				0 986 486 556	20,6	
1.4, 16V		10.04→	55/66/70				0 986 486 597	20,64	
1.3 Multijet		10.04-12.05	51-55				0 265 231 673 ^B		
		10.04-05.06	51-55				0 265 234 326 ^T		
		01.06-10.08	51-55				0 265 231 741 ^B		
			66				0 265 231 741 ^B		
		06.06-11.06	51-55				0 265 235 431 ^T		
			66				0 265 235 431 ^T		
		11.08-11.10	51-55			SSJ	0 265 230 010 ^T		
		03.09→	70				0 265 232 130 ^B		
						SSJ	0 265 230 010 ^T		
1.4		03.05-12.05	55				0 265 231 673 ^B		
							0 265 234 326 ^T		
		01.06-10.08	55				0 265 231 741 ^B		
		06.06-11.06	55				0 265 235 431 ^T		
		11.08→	55			SSJ	0 265 230 010 ^T		
1.4 LPG		03.09→	57				0 265 232 130 ^B		
						SSJ	0 265 230 010 ^T		
1.4 16V		10.04-12.04	70	Ricam.Nr →0084110			0 265 234 326 ^T		
		10.04-12.05	70				0 265 231 673 ^B		
		01.05-05.06	70	Ricam.Nr 0084111→			0 265 234 326 ^T		
		03.05-12.05	66				0 265 231 673 ^B		
							0 265 234 326 ^T		
		01.06-10.08	66				0 265 231 741 ^B		
			70				0 265 231 741 ^B		
		06.06-11.06	66				0 265 235 431 ^T		
			70				0 265 235 431 ^T		
		11.08→	66			SSJ	0 265 230 010 ^T		
			70			SSJ	0 265 230 010 ^T		
1.6 Multijet		10.07→	85/88				0 265 230 010 ^T		
							0 265 232 130 ^B		
		11.08→	85/88			SSJ	0 265 230 010 ^T		
1.9 Multijet		10.04-12.04	74	Ricam.Nr →0084110			0 265 234 326 ^T		
		10.04-12.05	74				0 265 231 673 ^B		
		01.05-05.06	74	Ricam.Nr 0084111→			0 265 234 326 ^T		
		01.06-10.08	74				0 265 231 741 ^B		
		06.06-11.06	74				0 265 235 431 ^T		
		11.08→	74			SSJ	0 265 230 010 ^T		

									
	1.3 Multijet	10.04-05.06	51-55				0 265 005 241		
	1.4 , 16V	10.04-05.06	55/66/70				0 265 005 241		
	1.9 Multijet	10.04-05.06	74				0 265 005 241		
Phedra [179]									
									
	2.0 JTD 16V	09.02-09.03	80/100	Ricam.Nr →9792			0 265 225 166^T		
	2.0 16V	09.02-10.05	80/100				0 265 222 010^B		
	2.2 JTD 16V	09.02-09.03	95	Ricam.Nr →9792			0 265 225 166^T		
		09.02-10.05	95				0 265 222 010^B		
	3.0 24V	09.02-09.03	150	Ricam.Nr →9792			0 265 225 166^T		
		09.02-09.05	150				0 265 222 010^B		
	2.0 JTD 16V	09.02-03.06	80	Ricam.Nr →10569			0 265 005 290		
				Ricam.Nr 10570→			0 265 005 606		
		03.06-12.10	88	Ricam.Nr 10570→			0 265 005 606		
		10.06-12.10	100	Ricam.Nr 10570→			0 265 005 606		
	2.0 16V	09.02-09.05	100	Ricam.Nr →10569			0 265 005 290		
	2.2 JTD 16V	09.02-09.07	95	Ricam.Nr →10569			0 265 005 290		
				Ricam.Nr 10570→			0 265 005 606		
		10.07-12.10	120/125				0 265 005 765		
	3.0 24V	09.02-09.05	150	Ricam.Nr →10569			0 265 005 290		
Thema Berlina [104]									
									
	2.5 TD	05.92-11.94	85				0 204 122 195	22,22	
	2.5 TD	05.92-11.94	85				0 204 125 362		
		01.93-11.94	85				0 204 125 409		
	ABS	05.92-11.94	85				0 204 125 409		
	2.0 i.e., i.e. 16V, i.e. 16V Turbo	05.92-11.94	84/112/148				0 265 204 004^B		
	2.5 TD	05.92-11.94	85				0 265 204 004^B		
	3.0 i.e.	05.92-11.94	126				0 265 204 004^B		
Thema Station Wagon [104]									
									
	2.5 TD	05.92-11.94	85				0 204 122 195	22,22	
	2.5 TD	05.92-11.94	85				0 204 125 362		
		01.93-11.94	85				0 204 125 409		
	ABS	05.92-11.94	85				0 204 125 409		
	2.0 i.e. 16V, i.e. 16V Turbo	05.92-11.94	112/148				0 265 204 004^B		
	2.5 TD	05.92-11.94	85				0 265 204 004^B		
	3.0 i.e.	05.92-11.94	126				0 265 204 004^B		
Y 10 [156]									
									
	1.1 i, i Selectronic, i 4x4	09.92-12.95	37/40		JBH		F 026 003 262	20,6	
	1.3 i	09.92-12.95	53		JBH		F 026 003 262	20,6	
	1.1 i, i Selectronic, i 4x4	09.92-12.95	37/40				0 204 125 371		
	1.3 i	09.92-12.95	53				0 204 125 371		

LANCIA Y 10 [156]									
	1.1 i, i Selectronic, i 4x4	09.92-12.95	37/40					0 204 131 226	
	1.3 i	09.92-12.95	53					0 204 131 226	
Y [840]									
	1.1 i.e.	04.97-06.00	40			JBH		F 026 003 266	20,6
	1.2 i 8V, i 16V	12.01-06.03	44/63					0 204 123 620	20,6
	1.2 i 8V, i 16V, i.e. 8V, i.e. 16V	01.96-11.01	44/63			JBH		F 026 003 266	20,6
	1.4 i.e. 12V	01.96-06.00	55/59			JBH		F 026 003 266	20,6
	1.1 i.e.	04.97-06.00	40					0 204 125 467	
	1.2 i 8V	06.00-06.03	44					0 204 125 467	
	1.2 i 16V, i.e. 16V	04.97-06.03	63					0 204 125 467	
	1.2 i.e. 8V	01.96-06.00	44					0 204 125 474	
	1.4 i.e. 12V	01.96-06.00	55/59					0 204 125 474	
	1.1 i.e.	04.97-06.00	40	Ricam.Nr →3336901	AG			0 265 216 408^B	
					GS			0 265 216 404^B	
				Ricam.Nr 3336902→				0 265 216 615^B	
	1.2 i 8V, i 16V	06.00-06.03	44/63					0 265 216 615^B	
	1.2 i.e. 8V	01.96-06.00	44/63	Ricam.Nr →3336901	AG			0 265 216 408^B	
	1.2 i.e. 16V				GS			0 265 216 404^B	
				Ricam.Nr 3336902→				0 265 216 615^B	
	1.4 i.e. 12V	01.96-06.00	55/59	Ricam.Nr →3336901	AG			0 265 216 408^B	
					GS			0 265 216 404^B	
				Ricam.Nr 3336902→				0 265 216 615^B	
Ypsilon [312]									
	0.9	06.11→	62,5					0 204 770 685	22,2
	1.2, Bi-Fuel	06.11→	51					0 204 770 685	22,2
	1.3 Multijet 16V	06.11→	70					0 204 770 685	22,2
	0.9	MFD 06.11→	62,5					0 204 770 683	
		OFD 06.11→	62,5					0 204 770 684	
	1.2	MFD 06.11→	51					0 204 770 683	
	1.2 Bi-Fuel	OFD 06.11→	51					0 204 770 684	
	1.3 Multijet 16V	MFD 06.11→	70					0 204 770 683	
		OFD 06.11→	70					0 204 770 684	
	1.2 Bi-Fuel	02.12→	51			TW		0 986 486 105	15,87
	1.2 Bi-Fuel	02.12→	51			TW		0 986 486 563	20,6
								0 986 486 597	20,64
Ypsilon [843]									
	1.2 16V	06.03-09.06	59					0 204 747 207	22,2
		MFD 06.03-09.06	59			JBH		F 026 003 628	22,2
		OFD 06.03-09.06	59					F 026 003 635	22,2
	1.2 8V	06.03-06.08	44					F 026 003 636	20,6
		06.03-11.11	44					0 204 747 206	20,6
		08.10-11.11	51			EU4		F 026 003 636	20,6
						EU5		0 204 747 206	20,6
	1.3 JTD	OFD 06.03-09.06	51					F 026 003 635	22,2
	1.3 JTD, Multijet	MFD 06.03-01.09	51/55/66/77			JBH		F 026 003 628	22,2
	1.3 Multijet	02.09-12.09	55					F 026 003 635	22,2

		S							
	1.3 Multijet	02.09-11.11	66				F 026 003 635	22,2	
			77				F 026 003 635	22,2	
		09.09-11.10	55		HAG		F 026 003 635	22,2	
	OFD	10.06-01.09	55				F 026 003 635	22,2	
			66				F 026 003 635	22,2	
			77				F 026 003 635	22,2	
	1.4 LPG	03.09-11.11	55				F 026 003 635	22,2	
	1.4 16V	02.09-11.11	70				F 026 003 635	22,2	
	OFD	06.03-01.09	70				F 026 003 635	22,2	
	1.4 16V, 8V	MFD 06.03-01.09	55/70		JBH		F 026 003 628	22,2	
	1.4 8V	02.09-11.11	55				F 026 003 635	22,2	
	OFD	10.06-01.09	55				F 026 003 635	22,2	
	1.2 16V, 8V	06.03-11.11	44/51/59			EU4	0 204 125 808		
	1.3 JTD, Multijet	06.03-11.11	51/55/66/77			EU4	0 204 125 808		
	1.4 LPG, 16V, 8V	06.03-11.11	55/70			EU4	0 204 125 808		
	1.2 8V	06.03-11.11	44				0 986 486 105	15,87	
		08.10-11.11	51		TW		0 986 486 105	15,87	
	1.4 LPG, 8V	10.06-11.11	55				0 986 486 105	15,87	
	1.2 16V	06.03-09.06	59				0 986 486 563	20,6	
	1.2 8V	06.03-11.11	44				0 986 486 597	20,64	
		08.10-11.11	51		TW		0 986 486 563	20,6	
							0 986 486 597	20,64	
	1.3 JTD, Multijet	06.03-11.11	51/55/66/77				0 986 486 556	20,6	
	1.4 LPG, 8V	10.06-11.11	55				0 986 486 597	20,64	
	1.4 16V	06.03-11.11	70				0 986 486 563	20,6	
Zeta [122]									
	2.0 i.e. Turbo	09.94-06.99	110				0 204 123 182	23,8	
	2.0 JTD, 16V	06.99-06.02	80/97		JBH		F 026 003 516	23,81	
	2.1 TD	05.96-06.99	80				0 204 123 182	23,8	
	2.0 JTD, 16V	06.99-06.02	80/97				0 204 125 715		
	2.1 TD	05.96-06.99	80				0 204 125 715		
	2.0 i.e. Turbo, JTD, 16V	06.99-06.02	80/97/110				0 204 131 082		
	2.0 i.e. Turbo, JTD, 16V	05.97-11.99	80/97/110	Ricam.Nr 7480→8419			0 265 216 496 ^B		
	2.1 TD	05.97-06.99	80	Ricam.Nr 7480→8419			0 265 216 496 ^B		
LAND ROVER GROUP									
Defender 90									
	2.5 AWD, D AWD, D Turbo AWD	ABO 08.90-12.01	50/62/80-83	Fg.-Nr. HA 701010→	JBH		0 986 480 825		
	3.5 AWD	ABO 08.90-12.98	100	Fg.-Nr. HA 701010→	JBH		0 986 480 825		
	4.0 4X4	ABO 09.93-08.97	135	Fg.-Nr. HA 701010→	JBH		0 986 480 825		
	2.4 Td4 AWD	05.07→	90-103				0 986 486 144	19,05	
	2.5 AWD, D AWD	08.90-09.01	50/62				0 986 486 509	22,2	



		S							
	LAND ROVER GROUP Defender 90								
	2.5 D Turbo AWD		08.90-12.01	80-83	Get.-Nr. für GetriebeLT77→, für GetriebeLT77S→		0 986 486 509		22,2
	2.2 Td4 AWD		09.11→	90	Fg.-Nr. BA000001→EA999999		0 265 251 924 ^T		
	2.4 Td4 AWD		05.07→	90-103	Fg.-Nr. BA000001→EA999999		0 265 251 924 ^T		
Defender 110									
	2.5 AWD, D AWD, D Turbo AWD	ABO	08.90-12.01	50-51/62/ 65-83	Fg.-Nr. HA 901220→	JBH	0 986 480 825		
	3.5 AWD	ABO	08.90-12.98	100	Fg.-Nr. HA 901220→	JBH	0 986 480 825		
	4.0 i AWD	ABO	09.95-12.01	134	Fg.-Nr. HA 901220→	JBH	0 986 480 825		
	2.4 Td4 AWD		08.07→	90-103			0 986 486 144		19,05
	2.5 AWD, D AWD		08.90-09.01	50-51/62			0 986 486 509		22,2
	2.5 D Turbo AWD		08.90-12.01	65-83	Get.-Nr. für GetriebeLT77→, für GetriebeLT77S→		0 986 486 509		22,2
	2.2 Td4 AWD	ABO	09.11→	90			0 986 482 016		
	2.4 Td4 AWD	ABO	08.07→	90-103			0 986 482 016		
	2.5 AWD, D AWD, D Turbo AWD, Td5 AWD		08.90-07.07	50-51/62/ 65-83/90			0 986 482 016		
	3.5 AWD		08.90-12.98	100			0 986 482 016		
	4.0 i AWD		09.95-12.01	134			0 986 482 016		
	2.2 Td4 AWD		09.11→	90	Fg.-Nr. BA000001→EA999999		0 265 251 924 ^T		
	2.4 Td4 AWD		08.07→	90-103	Fg.-Nr. BA000001→EA999999		0 265 251 924 ^T		
Defender 130									
	2.5 D AWD 2.5 D Turbo AWD	ABO	08.90-12.01	50/80-83	Fg.-Nr. HA 901220→	JBH	0 986 480 825		
	2.4 Td4 AWD		08.07→	90-103			0 986 486 144		19,05
	2.5 D AWD		08.90-09.01	50			0 986 486 509		22,2
	2.5 D Turbo AWD		08.90-12.01	80-83	Get.-Nr. für GetriebeLT77→, für GetriebeLT77S→		0 986 486 509		22,2
	2.2 Td4 AWD	ABO	09.11→	90			0 986 482 016		
	2.4 Td4 AWD	ABO	08.07→	90-103			0 986 482 016		
	2.5 D AWD, D Turbo AWD, Td5 AWD		08.90-07.07	50/80-83/90			0 986 482 016		
	2.2 Td4 AWD		09.11→	90	Fg.-Nr. BA000001→EA999999		0 265 251 924 ^T		
	2.4 Td4 AWD		08.07→	90-103	Fg.-Nr. BA000001→EA999999		0 265 251 924 ^T		
Discovery I									
	2.0 i 16V AWD	ABO	10.93-06.98	100	Fg.-Nr. →LA 081991		0 986 480 922		25,4
	2.5 TDi AWD	ABO	09.89-12.98	82-90	Fg.-Nr. →LA 081991		0 986 480 922		25,4
	3.5 AWD, i AWD	ABO	09.89-12.98	98-119	Fg.-Nr. →LA 081991		0 986 480 922		25,4
	3.9 i V8 AWD	ABO	10.93-12.99	134-136	Fg.-Nr. →LA 081991		0 986 480 922		25,4
	2.0 i 16V AWD		10.93-06.98	100			F 026 A01 908		
	2.5 TDi AWD		09.89-12.98	82-90	Fg.-Nr. (V) LA081991→		F 026 A01 908		

		S							
	3.5 i AWD	09.89-12.98	98-119				F 026	A01 908	
	3.9 i V8 AWD	10.93-12.99	134-136				F 026	A01 908	
Discovery III [TAA]									
	2.7 TDV6 AWD	09.04-08.09	140-147	Fg.-Nr. →6A999999			0 265	234 156^T	
	4.0 AWD	09.04-08.09	156-161	Fg.-Nr. →6A999999			0 265	234 156^T	
	4.4 AWD	09.04-08.09	220	Fg.-Nr. →6A999999			0 265	234 156^T	
	2.7 TDV6 AWD	09.04-08.09	140-147	Fg.-Nr. →6A398539			0 265	005 639	
				Fg.-Nr. 6A398540→			0 265	005 655	
	4.0 AWD	09.04-08.09	156-161	Fg.-Nr. →6A398539			0 265	005 639	
				Fg.-Nr. 6A398540→			0 265	005 655	
	4.4 AWD	09.04-08.09	220	Fg.-Nr. →6A398539			0 265	005 639	
				Fg.-Nr. 6A398540→			0 265	005 655	
Discovery IV [LA]									
	2.7 TDV6 AWD	09.09-08.10	140	Fg.-Nr. AA551484→BA999999			0 265	236 278^T	
	3.0 SDV6 AWD	09.09→	155/	Fg.-Nr. AA551484→BA999999			0 265	236 278^T	
	3.0 TDV6 AWD		180-200/						
	3.0 V6 Supercharged AWD		250						
	4.0 V6 AWD	09.09→	161	Fg.-Nr. AA551484→BA999999			0 265	236 278^T	
	5.0 V8 AWD	09.09→	276-280	Fg.-Nr. AA551484→BA999999			0 265	236 278^T	
Range Rover I									
	2.5 D Turbo AWD, TDi Classic AWD	ABO 09.90-09.94	83/89	Fg.-Nr. DA 301158→LA 647644			0 986	480 922	25,4
	3.9 i AWD, i Classic AWD	ABO 11.88-09.94	127/134	Fg.-Nr. DA 301158→LA 647644			0 986	480 922	25,4
	4.3 Vogue LSE AWD	ABO 09.92-09.94	147-149	Fg.-Nr. DA 301158→LA 647644			0 986	480 922	25,4
	2.5 D Turbo AWD, TDi Classic AWD	09.90-09.95	83/89				0 986	482 011	
	3.9 i AWD, i Classic AWD	11.88-04.96	127/134				0 986	482 011	
Range Rover II [LP]									
	2.5 TDi AWD	10.94-04.96	81-83	Fg.-Nr. (V) MA 647645→			F 026	A01 908	
	2.5 TDi AWD	10.94-04.96	81-83				0 986	482 011	
Range Rover III [LM L322]									
	3.0 Td6 AWD	03.02-09.06	130	Fg.-Nr. →6A999999	CS2		0 265	225 060^T	
	3.6 TDV8 AWD	09.06-08.09	200	Fg.-Nr. →6A999999			0 265	234 156^T	
	4.2 AWD	03.05-08.09	291	Fg.-Nr. →5A999999	CS2		0 265	225 060^T	
				Fg.-Nr. 6A000001→6A999999			0 265	234 156^T	
	4.4 V8 AWD	03.02-07.05	210	Fg.-Nr. →5A999999	CS2		0 265	225 060^T	
		05.05-08.09	220-225	Fg.-Nr. →5A999999	CS2		0 265	225 060^T	
				Fg.-Nr. 6A000001→6A999999			0 265	234 156^T	
	3.6 TDV8 AWD	09.06-08.09	200				0 265	005 655	
	4.2 AWD	03.05-08.09	291	Fg.-Nr. 5A000001→6A999999			0 265	005 639	
				Fg.-Nr. 7A000001→			0 265	005 655	
	4.4 V8 AWD	03.02-07.05	210	Fg.-Nr. →4A999999			0 265	005 248	
				Fg.-Nr. 5A000001→6A999999			0 265	005 639	





	◀ LAND ROVER GROUP Range Rover III [LM L322]						
	4.4 V8 AWD	05.05-08.09	220-225	Fg.-Nr. 5A000001→6A999999		0 265 005 639	
				Fg.-Nr. 7A000001→		0 265 005 655	

	3.0 Td6 AWD	03.02-09.06	130			0 265 005 303	
--	-------------	-------------	-----	--	--	---------------	--

Range Rover IV [LM L322]



	3.6 TDV8 AWD	09.09-01.13	200	Fg.-Nr. BA000001→		0 265 236 278 ^T	
	4.4 TDV8 AWD	09.10-01.13	230	Fg.-Nr. BA000001→		0 265 236 278 ^T	
	5.0 V8 AWD	09.09-01.13	276-280/	Fg.-Nr. BA000001→		0 265 236 278 ^T	
	5.0 V8 Supercharged AWD		375				

Range Rover Sport [LS L320]



	2.7 TD AWD	03.05-08.09	140	Fg.-Nr. →6A999999		0 265 234 156 ^T	
	3.0 SD AWD, TD AWD	09.09-08.13	155-188	Fg.-Nr. AA262642→BA999999		0 265 236 278 ^T	
	3.6 TD AWD	01.07-08.09	200	Fg.-Nr. →6A999999		0 265 234 156 ^T	
		09.09-08.13	200	Fg.-Nr. AA262642→BA999999		0 265 236 278 ^T	
	4.2 AWD	03.05-08.09	286-287	Fg.-Nr. →6A999999		0 265 234 156 ^T	
	4.4 AWD	03.05-08.09	220-225	Fg.-Nr. →6A999999		0 265 234 156 ^T	
	5.0 AWD	09.09-08.13	276-280/	Fg.-Nr. AA262642→BA999999		0 265 236 278 ^T	
	5.0 SC AWD		372-375				

	2.7 TD AWD	03.05-08.09	140	Fg.-Nr. →6A999999		0 265 005 639	
				Fg.-Nr. 7A000001→		0 265 005 655	
	3.6 TD AWD	01.07-08.09	200	Fg.-Nr. →6A999999		0 265 005 639	
				Fg.-Nr. 7A000001→		0 265 005 655	
	4.2 AWD	03.05-08.09	286-287	Fg.-Nr. →6A999999		0 265 005 639	
				Fg.-Nr. 7A000001→		0 265 005 655	
	4.4 AWD	03.05-08.09	220-225	Fg.-Nr. →6A999999		0 265 005 639	
				Fg.-Nr. 7A000001→		0 265 005 655	

LDV GROUP LIMITED

Maxus





























	2.5	01.05→	70-88			0 204 123 677	25,4
	2.5	01.05→	70-88			0 265 231 562 ^H	

LEXUS

ES [V]



	300 i	OFD 07.01-09.03	158				F 026 A07 016 ⁶
	330 i	OFD 07.01-03.06	168				F 026 A07 016 ⁶
	350 i	03.06-09.12	204			0 204 023 299	
	350 i	02.08-09.12	204			0 204 053 125	

		S							
ES [V6]									
									
	250 i	06.12→	135				0 204 790 459		
	350 i	06.12→	204				0 204 790 459		
IS [E2]									
									
	220 d	11.05-08.12	110/129-130		RLE		F 01G 061 0GP		
	350 i	08.10-04.13	233				F 01G 061 0FN		
LX [J8]									
									
	450 4x4	11.95-01.98	158						F 026 A03 420 ⁶
RC F [C1]									
									
	5.0	09.14→	351		LLE		F 01G 29B 1HW		
					RLE		F 01G 29B 1HW		
RX [U1]									
									
	300 4x4	01.98-07.00	164		TKO		F 026 A03 414 ⁶		
		07.00-07.00	148				F 026 A03 414 ⁶		
MAHINDRA									
Scorpio [MI]									
									
	2.6 D Turbo 4WD	06.02-03.06	80		TW		0 204 748 424		
Thar									
									
	2.5 D 4x4	12.10→	47/77				0 204 706 814		
XUV500									
									
	2.2 D	09.11→	103				0 204 712 040		
MAZDA									
Bongo Wagon									
									
	2.0 D Turbo	08.87-09.95	56				F 026 A01 843		



		S							
◀ MAZDA									
BT-50 [UN]									
	2.5 D Turbo 2.5 D Turbo 4x4	03.06-07.12	105				F 026 A09 620		
	2.5 D Turbo, D Turbo 4x4 3.0 D Turbo	03.06→ 03.06→	105 115				F 026 A06 933 F 026 A06 933		
CX-7 [ER]									
	2.3 MZR DISI Turbo 4x4	04.07-06.09	175/191	Fg.-Nr. →ER*9**200000	GS		0 265 234 608^T		
	2.2 MZR CD 4x4 2.3 MZR DISI Turbo 4x4 2.5	06.09→ 07.09→ 01.11→	120/127 175/191 120			Fg.-Nr. ER*9**200001→	0 265 005 768 0 265 005 768 0 265 005 768		
Demio [DW]									
	1.3 i	ABO 05.98-01.00 01.00-02.03	46 53 46			AG GS	F 01G 09B 24E F 01G 09B 24E F 01G 09B 1B4 F 01G 09B 24E		
		ABS 05.98-01.00 05.98-02.03	53 46				F 01G 09B 1B4 F 01G 09B 1B4		
	1.5 i	ABO 01.00-02.03	55			AG GS	F 01G 09B 1B4 F 01G 09B 24E		
		ABS 01.00-02.03	55				F 01G 09B 1B4		
E-Serie									
	2.0 i	09.90-04.97	71			JBH	0 986 480 673	22,2	
	2.0 i 2.2 D	09.90-04.97 08.99-12.01 03.97-08.99 08.99-01.10	71 71 52 52				F 01G 09B 0SB F 01G 09B 1HM F 01G 09B 1BK F 01G 09B 1X0		
	2.0 i 2.2 D	09.90-04.97 03.97-08.99	71 52				F 026 A01 843 F 026 A01 843		
	2.0 i	09.90-04.97 08.99-12.01	71 71				F 026 A02 524 F 026 A02 524		
	2.0 i 2.2 D	08.99-12.01 08.99-01.10	71 52				F 01G 09D 05S^B F 01G 09D 05S^B		
Marathon									
	2.2	08.91-08.97 09.97-02.01	77 77				F 026 A01 541 F 026 A01 683		F 026 A03 364⁶
	2.2	08.91-08.97 09.97-02.01	77 77				F 01G 09B 0SA F 01G 09B 1B9		



		S							
Millenia [TA]									
	2.3i 24V	08.00→	149				F 01G 09C 1CX		F 01G 09B 20V ⁶
MPV [LV]									
	3.0i	12.95→	115				F 026 A05 887		
	2.5 12VD Turbo	03.96-05.99	85				F 01G 09B 1C9		
	3.0i	12.95→	115				F 01G 09B 1HJ		
MPV [LW]									
	2.0D Turbo	03.02-09.03	100				F 01G 09B 1XE		
		10.03-06.04	100				F 01G 061 04H		
	2.0D Turbo	03.02-06.04	100				F 026 A07 715		
	2.0i 16V	06.99-04.02	90				F 026 A02 537		
	2.5i, i 24V	05.99→	125/129				F 026 A02 537		
MX-5 [NA]									
	1.8i	09.93-11.97	98		AZ4		F 026 A07 562		
	1.6i 16V	12.94-11.97	66				0 986 486 580	19	
	1.8i	09.93-11.97	96-98				0 986 486 580	19	
	1.6i 16V	12.94-11.97	66				F 01G 09D 02L ^H		
	1.8i	09.93-11.94	96-98				F 01G 09D 015 ^H		
		12.94-11.97	96-98				F 01G 09D 02L ^H		
MX-5 [NB]									
	1.6i	01.98-07.05	81				0 986 486 580	19	
	1.8i	01.98-07.05	103-106/107-113				0 986 486 580	19	
	1.6i	01.98-07.05	81				F 01G 09D 03E ^B		
	1.8i	01.98-07.05	103-106				F 01G 09D 03E ^B		
		09.00-07.05	107-113				F 01G 09D 03E ^H		
MX-5 [NC]									
	1.8	07.05-10.08	93				0 265 234 371 ^T		
	2.0	07.05-10.08	118				0 265 234 371 ^T		
	1.8	07.05-10.08	93	Fg.-Nr. →115416			0 265 005 254		
		11.08→	93				0 265 005 768		
	2.0	07.05-10.08	118	Fg.-Nr. →115416			0 265 005 254		
		11.08→	118				0 265 005 768		











		S				?			
◀ MAZDA									
MX-6 [GE]									
	2.5 i, i 4WS	ABO	07.94-06.97	121		GS	F 026 A01 599		
						Fg.-Nr. →GE*0*2-102491	AG	F 026 A01 594	
						Fg.-Nr. GE*0*2-102491→	AG	F 026 A01 594	
						GE*0*2-107543			
						Fg.-Nr. GE*0*2-107543→	AG	F 026 A01 594	
						GE*0*2-109786			
						Fg.-Nr. GE*0*2-109786→	AG	F 026 A01 594	
		ABS	07.94-06.97	121		Fg.-Nr. →GE*0*2-102491	AG	F 026 A01 593	
							GS	F 026 A07 564	
						Fg.-Nr. GE*0*2-102491→	AG	F 026 A01 593	
						GE*0*2-107543	GS	F 026 A07 564	
						Fg.-Nr. GE*0*2-107543→	AG	F 026 A01 593	
						GE*0*2-109786	GS	F 026 A07 564	
						Fg.-Nr. GE*0*2-109786→	AG	F 026 A01 593	
							GS	F 026 A07 564	
	2.0 i	ABS	07.91-06.94	85				F 01G 09B 10W	
	2.5 i	ABS	07.91-06.94	121-123				F 01G 09B 10W	
	2.5 i		07.94-06.97	121		AG	F 01G 09B 1B7		
	2.5 i 4WS	ABO	07.94-06.97	121		GS	F 01G 09B 10E		
		ABS	07.94-06.97	121		GS	F 01G 09B 10X		
	2.5 i 4WS		08.91-06.94	121-123			F 01G 09B 10W		
	2.5 i		07.94-06.97	121			F 026 A01 842		
	2.5 i 4WS								
	2.5 i		07.94-06.97	121			F 026 A02 537		
	2.5 i 4WS								
Premacy [CP]									
	1.8 i	MFD	03.99-05.05	74/84			F 01G 09B 1J8		
		OFD	03.99-05.05	74/84			F 01G 09B 1J5		
	2.0 D Turbo		06.99-05.05	66/74		Fg.-Nr. →350127	F 01G 09B 1M2		
						Fg.-Nr. 350128→	F 01G 09B 1M4		
	2.0 i	MFD	11.01-05.05	96			F 01G 09B 1J8		
		OFD	11.01-05.05	96			F 01G 09B 1J5		
	1.8 i		03.99-05.05	74/84			F 026 A07 715		
	2.0 D Turbo		06.99-05.05	66/74			F 026 A02 545		
	2.0 i		11.01-05.05	96			F 026 A02 604		
RX-7 Coupé [FD]									
	Biturbo		01.92-07.94	176			F 01G 09B 0W9		
			01.96→	204			F 01G 09B 1BJ		
	Biturbo		01.92→	176-177/ 204			F 026 A07 695		
	Biturbo		01.92-07.94	176			F 01G 09D 01M^H		
			08.93-06.94	176-177			F 01G 09D 01B^H		
			07.94-02.96	176-177		Fg.-Nr. 300038→	F 01G 09D 021^H		
			01.96→	204			F 01G 09D 022^H		

		S							
RX-8 [FE]									
		04.08-04.12	141-151/ 170				0 265 005 768		
RX-8 [SE]									
		04.03-04.08	141/170				0 265 225 243 ^T		
Serie B									
	2500 D	09.96-01.99	63-90				F 026 A01 829		
Serie B [UF]									
	2200	03.96-05.99	68				F 01G 09B 1J0		
	2500 12V D, 12VD 4x4	03.96-05.99	57-63				F 01G 09B 1CH		
	2600 i 12V 4x4	03.96-05.99	92				F 01G 09B 1J0		
	2200	03.96-05.99	68				F 026 A01 829		
	2200	03.96-05.99	68				F 026 A02 522		
	2500 12V D, 12VD 4x4	03.96-05.99	57-63				F 026 A02 522		
	2600 i 12V 4x4	03.96-05.99	92				F 026 A02 533		
Serie B [UN]									
	2200, 4x4	02.99-03.06	60-68				F 026 A01 829		
	2500 D, D Turbo, D Turbo 4x4, D 4x4	02.99-03.06	57/62				F 026 A01 829		
	2200, 4x4	02.99-03.06	60-68				F 026 A02 522		
	2500 D, D Turbo, D Turbo 4x4, D 4x4	02.99-03.06	57/62/64-80				F 026 A02 522		
	2600 4x4	02.99-03.06	90				F 026 A02 533		
Serie E									
	2.0, i	07.89-04.97	60-65/70			JBH	0 986 480 673	22,2	
	2.2 D	08.99-12.01	52			RLE	F 026 A01 759		
	2.2 D, D 4WD	07.89-04.97	44-47			JBH	0 986 480 673	22,2	
	2.0	07.89-03.95	60-65	Fg.-Nr. →SD022600602			F 01G 09B 0SA		
	2.0 i	08.91-04.97	70				F 01G 09B 0SB		
	2.2 D	07.89-04.97	44-47	Fg.-Nr. →SD022600602			F 01G 09B 0SA		
	2.2 D, D 4WD	03.97-12.01	52				F 01G 09B 1C8		
	2.0	07.89-03.95	60-65				F 026 A01 843		
	2.2 D	07.89-04.97	44-47				F 026 A01 843		
	2.2 D	03.97-12.01	52				F 01G 09D 055 ^B		
	2.2 D 4WD								



◀ MAZDA									
Tribute									
	2.0 i	12.00→	97					F 026 A07 615	
	3.0 i	12.00→	150					F 026 A07 615	
Xedos-6 [CA]									
	1.6 i	01.92-05.94	83-85					F 01G 09B 10D	
		ABS 01.92-05.94	83-85				AG	F 01G 09B 1B6	
	2.0 i	01.92-03.94	105-108					F 01G 09B 10W	
								F 01G 09B 1B1	
Xedos-9 [TA]									
	2.0 i	06.96-07.98	105					F 01G 09C 1AZ	F 01G 09C 1M9⁶
		08.98-07.00	105	Fg.-Nr. →301242				F 01G 09C 1AZ	F 01G 09B 20V⁶
	2.3 i Kompressor	06.96-07.98	155						F 01G 09B 20V⁶
		08.98-07.00	155	Fg.-Nr. →301242					F 01G 09B 20V⁶
				Fg.-Nr. 301242→				F 01G 09C 1CU	
	2.5 i	06.96-07.98	123				AG		F 01G 09B 20V⁶
							GS	F 01G 09C 1AZ	F 01G 09C 1M9⁶
		08.98-07.00	123	Fg.-Nr. →301242			AG		F 01G 09B 20V⁶
							GS	F 01G 09C 1AZ	F 01G 09B 20V⁶
				Fg.-Nr. 301242→			AG	F 01G 09C 1CU	
		08.00-11.02	120					F 01G 09C 1CU	
	2.5 i 4WS	06.96-07.98	123					F 01G 09C 1AZ	F 01G 09C 1M9⁶
	2.0 i	06.96-07.00	105					F 026 A02 537	
	2.5 i, i 4WS	06.96-07.00	123					F 026 A02 537	
2 [DE]									
	1.3	05.14→	55/62-63	Fg.-Nr. DEA4**515001→, DE10**282469→			RLE	0 204 023 916	
		MFD 06.07-04.14	55/62-63	Fg.-Nr. →DEA4**515000, →DE10**282468			RLE	0 204 023 916	
		06.07→	55/62-63				LLE	0 204 023 917	
		OFD 06.07-03.08	55/62-63	Fg.-Nr. →DE****168568			RLE	0 204 023 914	
		06.07→	55/62-63				LLE	0 204 023 915	
		04.08-04.14	55/62-63	Fg.-Nr. DE****168569→, →DEA4**515000, →DE10**282468			RLE	0 204 023 912	
	1.4 CD	MFD 08.07-09.10	50				AG,RLE	0 204 023 919	
							GS,RLE	0 204 023 916	
							LLE	0 204 023 917	
		OFD 08.07-10.08	50	Fg.-Nr. →DE****218701, →DE*3**214571			GS,RLE	0 204 023 914	
		08.07-09.10	50				AG,RLE	0 204 023 913	
							LLE	0 204 023 915	
		11.08-09.10	50	Fg.-Nr. DE****218702→, DE*3**214572→			GS,RLE	0 204 023 912	
	1.5	MFD 06.07→	75-76				AG,LLE	0 204 023 921	
							AG,RLE	0 204 023 919	
							GS,LLE	0 204 023 917	
							GS,RLE	0 204 023 916	
		OFD 06.07-03.08	75-76	Fg.-Nr. →DE****168568			GS,RLE	0 204 023 914	
		06.07→	75-76				AG,LLE	0 204 023 918	
							AG,RLE	0 204 023 913	



		S								
1.5	OFD	06.07→	75-76				GS,LLE	0 204 023 915		
		04.08→	75-76	Fg.-Nr. DE****168569→			GS,RLE	0 204 023 912		
1.6 CD	MFD	11.08-07.10	66	Fg.-Nr. →DEA**300000, →DEA**400000			LLE	0 204 023 917		
		11.08-09.10	66				AG,RLE	0 204 023 919		
							GS,RLE	0 204 023 916		
		08.10-09.10	66	Fg.-Nr. DEA3**300001→, DEA4**400001→			AG,LLE	0 204 023 921		
							GS,LLE	0 204 023 917		
		08.10→	70				AG,LLE	0 204 023 921		
							AG,RLE	0 204 023 919		
							GS,LLE	0 204 023 917		
							GS,RLE	0 204 023 916		
		OFD	11.08-07.10	66	Fg.-Nr. →DEA3**300000, →DEA4**400000			LLE	0 204 023 915	
			11.08-09.10	66				AG,RLE	0 204 023 913	
								GS,RLE	0 204 023 912	
			08.10-09.10	66	Fg.-Nr. DEA3**300001→, DEA4**400001→			AG,LLE	0 204 023 918	
								GS,LLE	0 204 023 915	
		08.10→	70				AG,LLE	0 204 023 918		
							AG,RLE	0 204 023 913		
							GS,LLE	0 204 023 915		
							GS,RLE	0 204 023 912		
 1.3		06.07-07.10	55/62-63	Fg.-Nr. →DEA3**300000, →DEA4**400000			LLE	0 204 023 925		
							RLE	0 204 023 924		
		05.14→	55/62-63	Fg.-Nr. DEA4**515001→, DE10**282469→				RLE	0 204 023 924	
		MFD	08.10-04.14	55/62-63	Fg.-Nr. DEA3**300001→, DEA4**400001→ DEA4**515000, →DE10**282468			RLE	0 204 023 924	
		08.10→	55/62-63	Fg.-Nr. DEA3**300001→, DEA4**400001→			LLE	0 204 023 925		
1.4 CD		08.07-10.08	50	Fg.-Nr. →DE****218701, →DE*3**214571			RLE	0 204 023 927		
		08.07-09.10	50				LLE	0 204 023 926		
		11.08-09.10	50	Fg.-Nr. DE****218702→, DE*3**214572→			RLE	0 204 053 425		
1.5		06.07-07.10	75-76	Fg.-Nr. →DEA3**300000, →DEA4**400000			LLE	0 204 023 925		
							RLE	0 204 023 924		
		05.14→	75-76	Fg.-Nr. DEA4**515001→, DE10**282469→				RLE	0 204 023 924	
		MFD	08.10-04.14	75-76	Fg.-Nr. DEA3**300001→, DEA4**400001→DEA4**515000, →DE10**282468			RLE	0 204 023 924	
		08.10→	75-76	Fg.-Nr. DEA3**300001→, DEA4**400001→			LLE	0 204 023 925		
1.6 CD		11.08-07.10	66	Fg.-Nr. →DEA3**300000, →DEA4**400000			LLE	0 204 023 926		
		12.08-07.10	66	Fg.-Nr. DE****218702→ DEA4**400000, DE*3**214572→DEA3**300000			RLE	0 204 053 425		
		MFD	08.10-09.10	66	Fg.-Nr. DEA3**300001→, DEA4**400001→			LLE	0 204 023 926	
					Fg.-Nr. DEA4**400001→, DEA3**300001→			RLE	0 204 053 425	
			08.10→	70				LLE	0 204 023 926	
							RLE	0 204 053 425		



		S				?			
◀ MAZDA									
3 [BK]									
	1.6	07.03-12.08	77	Fg.-Nr. →BK1...828359, →BK2...464020, →BK3...464020, →BK4...464020			0986 486 150	19,05	
	1.6 MZ-CD	12.03-12.08	80				0986 486 150	19,05	
	2.0, MZR-CD	07.03-12.08	105/110				0986 486 150	19,05	
3 [BL]									
	1.6 MZR-CD	12.08-10.13	80-81/85	LLE			0986 486 150	19,05	
	2.0 MZR	12.08→	110	LLE			0986 486 150	19,05	
	2.2 MZR-CD	01.09-07.11	110/136	LLE			0986 486 150	19,05	
3 Hatchback [BK]									
	1.4	08.03-12.08	59	Fg.-Nr. →BK1...828359			0986 486 150	19,05	
	1.6	10.03-12.08	77	Fg.-Nr. →BK1...828359, →BK2...464020, →BK3...464020, →BK4...464020			0986 486 150	19,05	
	1.6 MZ-CD	12.03-12.08	80				0986 486 150	19,05	
		10.05-12.08	66				0986 486 150	19,05	
	2.0, MZR-CD	07.03-12.08	105/110				0986 486 150	19,05	
	2.3 MPS	07.06-12.08	184-191				0986 486 150	19,05	
3 Hatchback [BL]									
	1.6 MZR-CD	12.08-10.13	80-81/85	LLE			0986 486 150	19,05	
	2.0 MZR	12.08→	110	LLE			0986 486 150	19,05	
	2.2 MZR-CD	01.09-10.13	110/136	LLE			0986 486 150	19,05	
	2.3 MPS	09.09-10.13	191	LLE			0986 486 150	19,05	
5 [CR]									
	1.8	02.05-12.10	85				0986 486 150	19,05	
	2.0, CD	02.05-12.10	81/101-107				0986 486 150	19,05	
5 [CW]									
	1.6 CD	06.10→	85	LLE			0986 486 150	19,05	
	1.8	06.10→	85	LLE			0986 486 150	19,05	
6 Fastback [GG/GY]									
	1.8	04.02-08.07	88	Fg.-Nr. →618037			F 026 A07 624		
	2.0	04.02-08.07	104-108	Fg.-Nr. →618037			F 026 A07 624		
	2.3	04.02-08.08	122	Fg.-Nr. →618037			F 026 A07 624		
	1.8	04.02-08.07	88				F 026 A02 605		
	2.0	04.02-08.07	104-108				F 026 A02 605		
	2.0 D Turbo	06.02-02.05	89/100-105				F 026 A07 715		
	2.3	04.02-08.08	122				F 026 A02 605		





6 Fastback [GH]

	1.8 MZR	MFD	08.07-12.12	88		LLE		0 204 023 960
		OFD	08.07-12.12	88		LLE	0 204 023 959	
	2.0 MZR	MFD	08.07-11.08	108	Fg.-Nr. →GH1...230195, →GH10..124695	AG,RLE		0 204 023 965
			08.07-12.12	108		GS,LLE		0 204 023 960
			12.08-12.12	108	Fg.-Nr. GH1...230196→, GH10..124696→	AG,RLE	0 204 023 970	
		OFD	08.07-11.08	108	Fg.-Nr. →GH1...230195, →GH10..124695	AG,RLE	0 204 023 966	
			08.07-12.12	108		AG,LLE	0 204 023 962	
						GS,LLE	0 204 023 959	
	2.0 MZR DISI		04.10-12.12	114		AG,RLE	0 204 023 970	
						GS,LLE		0 204 023 960
	2.0 MZR-CD	MFD	11.07-01.10	103		LLE		0 204 023 960
		OFD	11.07-01.10	103		LLE	0 204 023 959	
	2.2 MZR-CD		01.09-12.12	92/95/120/132/136		LLE		0 204 023 960
	2.5 MZR	MFD	08.07-12.12	125		LLE		0 204 023 960
		OFD	08.07-12.12	125		LLE	0 204 023 959	

	1.8 MZR	OFD	08.07-12.12	88		RLE		0 204 023 955
	2.0 MZR	OFD	08.07-12.12	108		RLE		0 204 023 955
	2.5 MZR	OFD	08.07-12.12	125		RLE		0 204 023 955

	1.8 MZR		08.07-12.12	88			F 026 A02 605	
	2.0 MZR, MZR DISI		08.07-12.12	108/114			F 026 A02 605	
	2.5 MZR		08.07-12.12	125			F 026 A02 605	

6 [GG/GY]

	2.3		02.02-08.07	122	Fg.-Nr. →618037		F 026 A07 624	
	2.3		02.02-08.07	122			F 026 A02 605	

























6 [GH]

	1.8 MZR	MFD	08.07-12.12	88		LLE		0 204 023 960
		OFD	08.07-12.12	88		LLE	0 204 023 959	
	2.0 MZR	MFD	08.07-11.08	108	Fg.-Nr. →GH1...230195, →GH10..124695	AG,RLE		0 204 023 965
			08.07-12.12	108		GS,LLE		0 204 023 960
			12.08-12.12	108	Fg.-Nr. GH1...230196→, GH10..124696→	AG,RLE	0 204 023 970	
		OFD	08.07-11.08	108	Fg.-Nr. →GH1...230195, →GH10..124695	AG,RLE	0 204 023 966	
			08.07-12.12	108		AG,LLE	0 204 023 962	
						GS,LLE	0 204 023 959	
	2.0 MZR DISI		04.10-12.12	114		AG,RLE	0 204 023 970	
						GS,LLE		0 204 023 960
	2.0 MZR-CD	MFD	11.07-01.10	103		LLE		0 204 023 960
		OFD	11.07-01.10	103		LLE	0 204 023 959	
	2.2 MZR-CD		01.09-12.12	92/95/120/132/136		LLE		0 204 023 960
	2.5 MZR	MFD	08.07-12.12	125		LLE		0 204 023 960
		OFD	08.07-12.12	125		LLE	0 204 023 959	



◀ MAZDA 6 [GH]									
	1.8 MZR	OFD	08.07-12.12	88		RLE			0 204 023 955
	2.0 MZR	OFD	08.07-12.12	108		RLE			0 204 023 955
	2.5 MZR	OFD	08.07-12.12	125		RLE			0 204 023 955
	1.8 MZR		08.07-12.12	88			F 026 A02 605		
	2.0 MZR, MZR DISI		08.07-12.12	108/114			F 026 A02 605		
	2.5 MZR		08.07-12.12	125			F 026 A02 605		
6 Sedan [GG/GY]									
	1.8		02.02-08.07	88	Fg.-Nr. →618037		F 026 A07 624		
	2.0		02.02-08.07	104-108	Fg.-Nr. →618037		F 026 A07 624		
	1.8		02.02-08.07	88			F 026 A02 605		
	2.0		02.02-08.07	104-108			F 026 A02 605		
	2.0 D Turbo		06.02-02.05	89/100-105			F 026 A07 715		
6 Wagon [GG/GY]									
	1.8		06.02-12.07	88	Fg.-Nr. →409616		F 026 A07 624		
	2.0		06.02-12.07	104-108	Fg.-Nr. →409616		F 026 A07 624		
	2.3, 4x4		06.02-12.07	119/122	Fg.-Nr. →409616		F 026 A07 624		
	1.8		06.02-12.07	88			F 026 A02 605		
	2.0		06.02-12.07	104-108			F 026 A02 605		
	2.0 D Turbo		06.02-02.05	89/100-105			F 026 A07 715		
	2.3, 4x4		06.02-12.07	119/122			F 026 A02 605		
6 Wagon [GH]									
	1.8 MZR	MFD	12.07-12.12	88		LLE			0 204 023 960
		OFD	12.07-12.12	88		LLE		0 204 023 959	
	2.0 MZR	MFD	12.07-11.08	108	Fg.-Nr. →GH1...230195, →GH10..124695	AG,RLE			0 204 023 965
			12.07-12.12	108		GS,LLE			0 204 023 960
			12.08-12.12	108	Fg.-Nr. GH1...230196→, GH10..124696→	AG,RLE		0 204 023 970	
		OFD	12.07-11.08	108	Fg.-Nr. →GH1...230195, →GH10..124695	AG,RLE		0 204 023 966	
			12.07-12.12	108		AG,LLE		0 204 023 962	
	2.0 MZR DISI					GS,LLE		0 204 023 959	
						AG,RLE		0 204 023 970	
	2.0 MZR-CD	MFD	12.07-01.10	103		LLE			0 204 023 960
		OFD	12.07-01.10	103		LLE		0 204 023 959	
	2.2 MZR-CD		10.08-12.12	92/95/120/132/136		LLE			0 204 023 960
	2.5 MZR	MFD	12.07-12.12	125		LLE			0 204 023 960
		OFD	12.07-12.12	125		LLE		0 204 023 959	
		1.8 MZR	OFD	12.07-12.12	88		RLE		
2.0 MZR		OFD	12.07-12.12	108		RLE			0 204 023 955
2.5 MZR		OFD	12.07-12.12	125		RLE			0 204 023 955
	1.8 MZR		12.07-12.12	88			F 026 A02 605		
	2.0 MZR, MZR DISI		12.07-12.12	108/114			F 026 A02 605		
	2.5 MZR		12.07-12.12	125			F 026 A02 605		























		S							
121 [DB]									
									
	1.3i		11.93-11.97	54/55			F 026	A01 592	
121 [JA/JB]									
									
	1.3i	ABO	01.96-01.02	37/44		JBH	0 986	480 679	22,2
	1.8D	ABO	01.96-01.02	44		JBH	0 986	480 679	22,2
	1.25 i 16V	ABO	01.96-10.99	55	Fg.-Nr. →000201	GS,JBH	0 986	480 679	22,2
			11.99-01.02	55		GS,JBH	0 986	480 679	22,2
121 METRO Wagon [DW]									
									
	1.3i	ABO	01.00-12.02	53			F 026	A01 595	
	1.3i		08.96-12.99	53			F 01G	09B 0YS	
		ABO	01.00-12.02	53	Fg.-Nr. →DW10*2-203028		F 01G	09B 0YT	
					Fg.-Nr. DW10*2-203029→		F 01G	09B 1P4	
		ABS	01.00-12.02	53			F 01G	09B 1P5	
323 Astina [BA]									
									
	1.8i	ABO	10.96-06.98	92	Fg.-Nr. →BA11*3-230185		F 026	A07 621	
					Fg.-Nr. BA11*3-230186→		F 026	A07 621	
	1.8i		10.96-06.98	92		GS	F 01G	09B 11L	
	1.8i		10.96-06.98	92			F 026	A01 874	
	1.8i		10.96-06.98	92			F 026	A07 694	
323 Astina Hatchback [BA]									
									
	1.8i	ABO	05.94-09.95	92			F 026	A01 653	
	2.0i		05.94-09.95	104	Fg.-Nr. →BA11**-111406	AG			F 01G 09B 20N ⁶
						GS			F 01G 09B 20S ⁶
					Fg.-Nr. BA11**-111406→	AG	F 01G	09C 1BF	F 01G 09B 20N ⁶
						GS	F 026	A01 663	F 01G 09B 20S ⁶
	1.8i		05.94-09.95	92		AG	F 01G	09B 1BH	
						GS	F 01G	09B 11K	
	2.0i		05.94-09.95	104		GS	F 01G	09B 10P	
	1.8i		05.94-09.95	92			F 026	A01 874	
	2.0i		05.94-09.95	104			F 026	A01 874	
	1.8i		05.94-09.95	92			F 026	A07 694	
	2.0i		05.94-09.95	104			F 026	A02 537	



◀ MAZDA									
323 [BA]									
	1.6 i	ABO	08.95-09.96	78	Fg.-Nr. →BA11**-100848	GS	F 026 A01 653		
					Fg.-Nr. BA11**-100848→	GS	F 026 A01 653		
					BA11**-109592				
	1.6 i		08.95-09.96	78		AG	F 01G 09B 1BH		
						GS	F 01G 09B 11K		
	1.6 i		08.95-09.96	78			F 026 A07 181		
	1.6 i		08.95-09.96	78			F 026 A07 694		
323 [BG]									
	1.6		07.89-12.95	64	Fg.-Nr. →BG10*1-100929	AG	F 026 A01 684		
						GS	F 026 A07 556		
					Fg.-Nr. BG10*1-100929→	GS	F 026 A07 556		
					Fg.-Nr. BG10*1-100930→	AG	F 026 A01 684		
	1.8 i		04.91-05.94	76		AG	F 026 A07 565		
						GS	F 026 A07 556		
	1.8 i		04.91-05.94	76		AG	F 01G 09B 0TU		
	1.6		07.89-12.95	64			F 026 A07 181		
	1.8 i		04.91-05.94	76			F 026 A07 181		
	1.6		07.89-12.95	64			F 026 A07 694		
	1.8 i		04.91-05.94	76			F 026 A07 694		
323 [BJ]									
	1.6 i		07.98-11.00	78			F 026 A01 728		
	1.8 i	ABO	07.98-11.00	92			F 026 A01 728		
	1.3 i		05.98-09.03	54			F 01G 09B 1BL		
	1.5 i		05.98-10.00	65			F 01G 09B 1BL		
	1.6 i		07.98-11.00	78			F 01G 09B 10G		
		ABO	07.98-10.00	79			F 01G 09B 1BL		
		OFD	10.00-09.03	70-72			F 01G 09B 1CV		
	1.8 i		05.98-09.03	84			F 01G 09B 1BL		
			07.98-11.00	92			F 01G 09B 10G		
		OFD	01.01-09.03	84			F 01G 09B 1CV		
	2.0 D Turbo		10.00-09.03	74			F 01G 09B 23T		
	2.0 D, D Turbo		05.98-10.00	52/66			F 01G 09B 1CC		
	2.0 i	OFD	09.00-08.03	96			F 01G 09B 1CV		
	1.6 i		07.98-11.00	78			F 026 A01 842		
	1.8 i		07.98-11.00	92			F 026 A01 910		
	1.3 i		05.98-09.03	54			F 026 A07 694		
	1.5 i		05.98-10.00	65			F 026 A07 694		
	1.6 i		07.98-09.03	70-72/78/79			F 026 A07 694		
	1.8 i		05.98-09.03	84/92			F 026 A07 715		



		S							
2.0D		05.98-10.00	52				F 026 A07 694		
2.0D Turbo		07.98-09.03	66/74				F 026 A02 545		
2.0i		09.00-08.03	96				F 026 A02 604		
323 Hatchback [BA]									
									
	P 2.0 D	03.97-09.00	52				F 01G 09C 1BG		F 01G 09B 20N ⁶
	1.8 i Astina	ABO 08.95-09.96	92	Fg.-Nr. →BA11*-109592	GS		F 026 A01 653		
		10.96-06.98	92	Fg.-Nr. →BA11*3-230185			F 026 A07 621		
				Fg.-Nr. BA11*3-230186→			F 026 A07 621		
	1.8 i Astina	08.95-09.96	92		AG		F 01G 09B 1BH		
					GS		F 01G 09B 11K		
		10.96-06.98	92		GS		F 01G 09B 11L		
	1.8 i Astina	08.95-06.98	92				F 026 A01 874		
	P 1.3 i	10.96-09.00	54-55				F 026 A07 694		
	P 1.5 i	10.96-09.00	65				F 026 A07 694		
	P 2.0 D	03.97-09.00	52				F 026 A07 694		
	1.8 i Astina	08.95-06.98	92				F 026 A07 694		
323 Hatchback [BG]									
									
	1.8 i	04.91-05.94	76/92		AG		F 026 A07 565		
	1.8 i 16V				GS		F 026 A07 556		
	1.6 i 16V	ABS 03.91-07.94	65-66				F 01G 09B 0YC		
	1.8 i, i 16V	04.91-05.94	76/92		AG		F 01G 09B 0TU		
	1.8 i	04.91-05.94	76/92				F 026 A07 181		
	1.8 i 16V								
	1.8 i	04.91-05.94	76/92				F 026 A07 694		
	1.8 i 16V								
323 Hatchback [BJ]									
									
	1.6 i	07.98-11.00	78				F 026 A01 728		
		ABO 12.00→	78				F 026 A01 727		
	1.8 i	ABO 07.98→	92				F 026 A01 728		
	2.0i	ABO 12.00→	98				F 026 A01 728		
	P 1.3 i	09.98-10.00	54				F 01G 09B 1BL		
	P 1.5 i	09.98-10.00	65				F 01G 09B 1BL		
	1.3 i	06.98-09.03	54				F 01G 09B 1BL		
	1.5 i	06.98-01.01	65				F 01G 09B 1BL		
	1.6 i	07.98-11.00	78				F 01G 09B 10G		
		ABO 12.00→	78				F 01G 09B 10G		
		OFD 10.00-09.03	70-72				F 01G 09B 1CV		
	1.8 i	06.98-01.01	84				F 01G 09B 1BL		
		07.98→	92				F 01G 09B 10G		
		OFD 12.00-09.03	84				F 01G 09B 1CV		
	2.0D Turbo	11.00-09.03	74				F 01G 09B 23T		
	2.0D, D Turbo	06.98-01.01	52/66				F 01G 09B 1CC		
	2.0i	12.00→	98				F 01G 09B 10G		
		OFD 10.00-09.03	96				F 01G 09B 1CV		





◀ MAZDA 323 Hatchback [BJ]

	1.6 i	07.98→	78			F 026 A01 842
	1.8 i	07.98→	92			F 026 A01 910
	2.0 i	12.00→	98			F 026 A07 614
	P 1.3 i	09.98-10.00	54			F 026 A07 694
	P 1.5 i	09.98-10.00	65			F 026 A07 694
	1.3 i	06.98-09.03	54			F 026 A07 694
	1.5 i	06.98-01.01	65			F 026 A07 694
	1.6 i	07.98→	70-72/78			F 026 A07 694
	1.8 i	06.98→	84/92			F 026 A07 715
	2.0 D	06.98-09.99	52			F 026 A07 694
	2.0 D Turbo	08.98-09.03	66/74			F 026 A02 545
	2.0 i	10.00→	96/98			F 026 A02 604

323 Sedan [BA]

	2.0 i Astina	ABO	08.95-09.96	104	Fg.-Nr. →BA11*-109592	GS F 026 A01 653
	2.0 i Astina		08.95-09.96	104		AG F 01G 09B 1BH GS F 01G 09B 11K
	2.0 i Astina		08.95-09.96	104		F 026 A01 874
	2.0 i Astina		08.95-09.96	104		F 026 A02 537

323 Sedan [BG]

	1.6 i 16V	ABS	03.91-02.97	65-66		F 01G 09B 0YC
	1.8 i 16V	ABS	04.91-07.94	76-78		F 01G 09B 0YC

323 Wagon [BW]













	1.5		09.89-06.95	54		F 01G 09B 0PC

626

	2.0 i 16V		05.93-01.96	85/107	AG,FBM	F 026 A01 594
	2.0 i 24V		05.93-02.96	85/107	FBM,MG5	F 026 A01 599
	2.5 i 24V		04.93-01.96	121	AG,FBM	F 026 A01 594
			04.93-12.96	121	FBM,MG5	F 026 A01 599
	2.0 i 16V		05.93-02.96	85/107		F 01G 09B 1B7
	2.0 i 24V				FBM	F 01G 09B 10E
	2.5 i 24V		04.93-12.96	121		F 01G 09B 1B7
					FBM	F 01G 09B 10E













626 Fastback [GF]

	1.8 i 16V		08.99-06.00	66/74		F 01G 09B 10J

		S													
2.0i 16V									08.99-06.00 85	F 01G 09B 10J					
									08.99-04.02 85	AG	F 01G 09B 1BB				
										GS	F 01G 09B 10J				
									100	AG	F 01G 09B 1BB				
										GS	F 01G 09B 10J				
2.0 16V D Turbo									08.99-07.00 74	F 01G 09B 10U					
									1.8i 16V	08.99-06.00 66/74	F 026 A02 537				
									2.0i 16V	08.99-04.02 85/100	F 026 A02 537				
									2.0 16V D Turbo	08.99-07.00 74	F 026 A02 545				
626 [GE]															
															
		ABO								2.0i 16V	11.91-05.94 85-86	AG	F 026 A01 594		
												Fg.-Nr. →GE1***-101502	GS	F 026 A01 599	
												Fg.-Nr. GE1***-101502→	GS	F 026 A01 599	
											06.94-06.97 85-86		GS	F 026 A01 599	
												Fg.-Nr. →GE*0*2-102491	AG	F 026 A01 594	
												Fg.-Nr. GE*0*2-102491→	AG	F 026 A01 594	
												GE*0*2-107543			
												Fg.-Nr. GE*0*2-107543→	AG	F 026 A01 594	
												GE*0*2-109786			
												Fg.-Nr. GE*0*2-109786→	AG	F 026 A01 594	
											ABS 11.91-05.94 85-86		AG	F 026 A01 593	
													GS	F 026 A07 564	
											06.94-06.97 85-86	Fg.-Nr. →GE*0*2-102491	AG	F 026 A01 593	
													GS	F 026 A07 564	
												Fg.-Nr. GE*0*2-102491→	AG	F 026 A01 593	
												GE*0*2-107543	GS	F 026 A07 564	
												Fg.-Nr. GE*0*2-107543→	AG	F 026 A01 593	
												GE*0*2-109786	GS	F 026 A07 564	
												Fg.-Nr. GE*0*2-109786→	AG	F 026 A01 593	
													GS	F 026 A07 564	
											2.5i 24V	ABO 04.92-05.94 121			AG
			Fg.-Nr. →GE1***-101502	GS	F 026 A01 599										
			Fg.-Nr. GE1***-101502→	GS	F 026 A01 599										
		06.94-06.97 121			GS	F 026 A01 599									
			Fg.-Nr. →GE*0*2-102491	AG	F 026 A01 594										
			Fg.-Nr. GE*0*2-102491→	AG	F 026 A01 594										
			GE*0*2-107543												
			Fg.-Nr. GE*0*2-107543→	AG	F 026 A01 594										
			GE*0*2-109786												
			Fg.-Nr. GE*0*2-109786→	AG	F 026 A01 594										
		ABS 04.92-05.94 121			AG	F 026 A01 593									
					GS	F 026 A07 564									
		06.94-06.97 121	Fg.-Nr. →GE*0*2-102491	AG	F 026 A01 593										
					GS	F 026 A07 564									
			Fg.-Nr. GE*0*2-102491→	AG	F 026 A01 593										
			GE*0*2-107543	GS	F 026 A07 564										
			Fg.-Nr. GE*0*2-107543→	AG	F 026 A01 593										
			GE*0*2-109786	GS	F 026 A07 564										
			Fg.-Nr. GE*0*2-109786→	AG	F 026 A01 593										
					GS	F 026 A07 564									
										1.8i 16V	08.91-03.97 66/77	AG	F 01G 09B 1B6		
											ABO 08.91-03.97 66/77	GS	F 01G 09B 10D		
											ABS 08.91-03.97 66/77	GS	F 01G 09B 10W		
											2.0i 16V	11.91-05.94 85-86	DAM.-Nr. GE1***-100656→	AG	F 01G 09B 1B7
												06.94-06.97 85-86		AG	F 01G 09B 1B7
											ABO 11.91-06.97 85-86			GS	F 01G 09B 10E
											ABS 11.91-06.97 85-86			GS	F 01G 09B 10X



		S							
MAZDA 626 [GE]									
	2.0 i 16V			08.91-03.97	85-86		AG	F 01G	09B 1B6
	2.0 i 16V 4x4	A		08.91-03.97	85-86		GS	F 01G	09B 10D
			A	08.91-03.97	85-86		GS	F 01G	09B 10W
	2.5 i 24V			04.92-05.94	121	DAM.-Nr. GE1***-100656→	AG	F 01G	09B 1B7
				06.94-06.97	121		AG	F 01G	09B 1B7
		A		04.92-06.97	121		GS	F 01G	09B 10E
			A	04.92-06.97	121		GS	F 01G	09B 10X
	1.8 i 16V			08.91-03.97	66/77			F 026	A01 842
	2.0 D Comprex			03.92-03.97	55			F 026	A01 842
	2.0 i 16V			08.91-03.97	85-86			F 026	A01 842
	2.5 i 24V			04.92-06.97	121			F 026	A01 842
	1.8 i 16V			08.91-03.97	66/77			F 026	A02 537
	2.0 D Comprex			03.92-03.97	55			F 026	A02 545
	2.0 i 16V			08.91-06.97	85-86			F 026	A02 537
	2.5 i 24V			04.92-06.97	121			F 026	A02 537
626 [GF]									
	2.0 i 16V	A		06.97-10.99	93		GS	F 026	A01 599
						Fg.-Nr. →GF**S*-107321	AG	F 026	A01 594
						Fg.-Nr. GF**S*-107321→	AG	F 026	A01 594
		A		06.97-10.99	93	Fg.-Nr. →GF**S*-107321	AG	F 026	A01 716
							GS	F 026	A01 715
						Fg.-Nr. GF**S*-107321→	AG	F 026	A01 716
							GS	F 026	A01 715
	1.8 i 16V			09.99-03.02	66/74			F 01G	09B 10J
			A	05.97-09.99	66-67		GS	F 01G	09B 10Y
	2.0 i 16V			06.97-10.99	93	Fg.-Nr. GF**S*-105691→	AG	F 01G	09B 1BA
				11.98-04.02	100		AG	F 01G	09B 1BB
							GS	F 01G	09B 10J
				09.99-06.00				F 01G	09B 10J
				09.99-04.02	85		AG	F 01G	09B 1BB
							GS	F 01G	09B 10J
		A		06.97-10.99	93	Fg.-Nr. →GF**S*-105691	GS	F 01G	09B 10G
						Fg.-Nr. GF**S*-105691→	GS	F 01G	09B 10H
		A		05.97-09.99	85		GS	F 01G	09B 10Y
				06.97-10.99	93	Fg.-Nr. GF**S*-105691→	GS	F 01G	09B 10V
	2.0 16V D Turbo			09.99-07.02	74/81			F 01G	09B 10U
	2.0 i 16V			06.97-10.99	93			F 026	A01 842
	1.8 i 16V			05.97-03.02	66-67/74			F 026	A02 537
	2.0 i 16V			05.97-04.02	85/93/100			F 026	A02 537
				09.99-06.00				F 026	A02 537
	2.0 16V D Turbo			09.99-07.02	74/81			F 026	A02 545
626 Hatchback [GE]									
	2.0 i 16V	A		11.91-05.94	85-86		AG	F 026	A01 594
						Fg.-Nr. →GE1***-101502	GS	F 026	A01 599
						Fg.-Nr. GE1***-101502→	GS	F 026	A01 599
				06.94-06.97	85-86		GS	F 026	A01 599
						Fg.-Nr. →GE*0*2-102491	AG	F 026	A01 594
						Fg.-Nr. GE*0*2-102491→	AG	F 026	A01 594
						GE*0*2-107543			
						Fg.-Nr. GE*0*2-107543→	AG	F 026	A01 594
						GE*0*2-109786			

		S								
2.0i 16V	ABO	06.94-06.97	85-86	Fg.-Nr. GE*0*2-109786→	AG	F 026 A01 594				
		ABS	11.91-05.94	85-86		AG	F 026 A01 593			
					GS	F 026 A07 564				
		06.94-06.97	85-86	Fg.-Nr. →GE*0*2-102491	AG	F 026 A01 593				
					GS	F 026 A07 564				
				Fg.-Nr. GE*0*2-102491→	AG	F 026 A01 593				
				GE*0*2-107543	GS	F 026 A07 564				
				Fg.-Nr. GE*0*2-107543→	AG	F 026 A01 593				
				GE*0*2-109786	GS	F 026 A07 564				
				Fg.-Nr. GE*0*2-109786→	AG	F 026 A01 593				
				GS	F 026 A07 564					
2.5i	ABO	11.91-05.94	121		AG	F 026 A01 594				
				Fg.-Nr. →GE1***-101502	GS	F 026 A01 599				
	ABS	11.91-05.94	121	Fg.-Nr. GE1***-101502→	GS	F 026 A01 599				
				AG	F 026 A01 593					
				GS	F 026 A07 564					
2.5i 24V	ABO	06.94-06.97	121		GS	F 026 A01 599				
				Fg.-Nr. →GE*0*2-102491	AG	F 026 A01 594				
				Fg.-Nr. GE*0*2-102491→	AG	F 026 A01 594				
				GE*0*2-107543						
				Fg.-Nr. GE*0*2-107543→	AG	F 026 A01 594				
			GE*0*2-109786							
			Fg.-Nr. GE*0*2-109786→	AG	F 026 A01 594					
	ABS	06.94-06.97	121	Fg.-Nr. →GE*0*2-102491	AG	F 026 A01 593				
					GS	F 026 A07 564				
				Fg.-Nr. GE*0*2-102491→	AG	F 026 A01 593				
			GE*0*2-107543	GS	F 026 A07 564					
			Fg.-Nr. GE*0*2-107543→	AG	F 026 A01 593					
			GE*0*2-109786	GS	F 026 A07 564					
			Fg.-Nr. GE*0*2-109786→	AG	F 026 A01 593					
				GS	F 026 A07 564					
	1.8i 16V	09.91-03.97	66/77		AG	F 01G 09B 1B6				
		ABS	09.91-03.97	66/77		GS	F 01G 09B 10W			
2.0i 16V		11.91-05.94	85-86	DAM.-Nr. GE1***-100656→	AG	F 01G 09B 1B7				
		06.94-06.97	85-86		AG	F 01G 09B 1B7				
	ABO	11.91-06.97	85-86		GS	F 01G 09B 10E				
	ABS	11.91-06.97	85-86		GS	F 01G 09B 10X				
2.0i 16V		09.91-03.97	85-86		AG	F 01G 09B 1B6				
2.0i 16V 4x4	ABS	09.91-03.97	85-86		GS	F 01G 09B 10W				
2.5i		11.91-05.94	121	DAM.-Nr. GE1***-100656→	AG	F 01G 09B 1B7				
2.5i	ABO	11.91-06.97	121		GS	F 01G 09B 10E				
2.5i 24V	ABS	11.91-06.97	121		GS	F 01G 09B 10X				
2.5i 24V		06.94-03.97	121		AG	F 01G 09B 1B6				
		06.94-06.97	121		AG	F 01G 09B 1B7				
	ABS	06.94-03.97	121		GS	F 01G 09B 10W				
2.5i 24V		09.91-05.94	121-123		AG	F 01G 09B 1B6				
2.5i 24V 4WS	ABS	09.91-05.94	121-123		GS	F 01G 09B 10W				
	1.8i 16V	09.91-03.97	66/77			F 026 A01 842				
		2.0D Complex, i 16V	09.91-06.97	55/85-86			F 026 A01 842			
		2.5i, i 24V, i 24V 4WS	09.91-06.97	121-123			F 026 A01 842			
	1.8i 16V	09.91-03.97	66/77			F 026 A02 537				
		2.0D Complex	03.92-03.97	55			F 026 A02 545			
		2.0i 16V	11.91-06.97	85-86			F 026 A02 537			
		2.5i, i 24V	11.91-06.97	121			F 026 A02 537			
626 Hatchback [GF]										
	2.0i 16V	ABO	05.97-10.99	93		GS	F 026 A01 599			
					Fg.-Nr. →GF**S*-107321	AG	F 026 A01 594			
					Fg.-Nr. GF**S*-107321→	AG	F 026 A01 594			



		S											
MAZDA 626 Hatchback [GF]													
	2.0 i 16V	ABS	05.97-10.99	93	Fg.-Nr. →GF**S*-107321	AG	F 026 A01 716						
						GS	F 026 A01 715						
						Fg.-Nr. GF**S*-107321→	AG	F 026 A01 716					
							GS	F 026 A01 715					
	1.8 i 16V	04.97-09.99	66-67	Fg.-Nr. 244666→	AG	F 01G 09B 1BB							
					GS	F 01G 09B 10J							
	2.0 i 16V	04.97-10.99	85/93/100	Fg.-Nr. 244666→	AG	F 01G 09B 1BB							
					GS	F 01G 09B 10J							
	2.0 16V D Turbo	04.98-08.99	66		F 01G 09B 10U								
		10.00-07.02	81		F 01G 09B 10U								
	2.0 i 16V	07.97-10.99	93			F 026 A01 842							
	1.8 i 16V, 16V	04.97-09.99	66-67				F 026 A02 537						
							2.0 i 16V, 16V	04.97-10.99	85/93/100		F 026 A02 537		
	2.0 16V D Turbo	04.98-08.99	66		F 026 A02 545								
		10.00-07.02	81		F 026 A02 545								
626 Wagon [GV]													
	2.0 i, i 16V	03.92-04.96	66/103				F 01G 09B 10K						
							2.2 i	03.92-10.97	85		F 01G 09B 10K		
626 Wagon [GW]													
	1.8 i 16V	10.99-04.02	74				F 01G 09B 1BB						
							2.0 D Turbo	09.99-04.02	66/74/81		F 01G 09B 10U		
							2.0 i 16V	11.99-04.02	85/100		F 01G 09B 1BB		
	1.8 i 16V	10.97-04.02	66/74				F 026 A02 537						
							2.0 D Turbo, 16V D Turbo	05.98-04.02	66/74/81		F 026 A02 545		
							2.0 i 16V	10.97-04.02	85/100-100		F 026 A02 537		
MERCEDES-BENZ													
Classe A [168]													
	190	09.00-08.05	92	Fg.-Nr. →A029700		JPH	0986 480 936	22,2					
										190	09.00-08.05	92	
	190	09.00-08.05	92	Fg.-Nr. →J247148	Fg.-Nr. J247149→J569589	Fg.-Nr. J568590→	0265 217 004 ^T						
							0265 202 414 ^T						
							0265 202 463 ^T						
	190	09.00-08.05	92	Fg.-Nr. →A004244	Fg.-Nr. A004245→	Fg.-Nr. J568590→	HKA	0265 109 468 ^M					
							FGN	0265 109 459 ^M					
							FGN	0265 109 477 ^M					
							FGN	0265 109 630 ^M					
	190	09.00-08.05	92				0265 005 258						
	190	09.00-08.05	92				0265 005 303						





MB

















	100 D	09.91-01.96	55	Fg.-Nr. →021971 Fg.-Nr. 021972→		0 986 480 725 0 986 480 726	25,4 25,4
	100 100 D	01.87-04.96	43/55			0 204 031 300 ^A	
	100	01.96→	58/69-70			1 267 000 814 ^H	

Serie A [168]

	140 160, CDI 170 CDI 190 210 Evolution	10.97-08.04 10.97-08.04 07.98-08.04 03.99-08.04 03.02-08.04	60 44/55/75 66/70 92 103		JBH JBH JBH JBH JBH	0 986 480 936 0 986 480 936 0 986 480 936 0 986 480 936 0 986 480 936	22,2 22,2 22,2 22,2 22,2
	140 160 160 CDI 170 CDI 190 210 Evolution	10.97-08.04 10.97-08.04 07.98-08.04 03.99-08.04 03.02-08.04	60 44/55/75 66/70 92 103	Fg.-Nr. →J 080609 Fg.-Nr. J 080610→ Fg.-Nr. →J 080609 Fg.-Nr. J 080610→ Fg.-Nr. →J 080609 Fg.-Nr. J 080610→ Fg.-Nr. →J 080609 Fg.-Nr. J 080610→		0 986 486 141 0 986 486 108 0 986 486 141 0 986 486 108 0 986 486 141 0 986 486 108 0 986 486 141 0 986 486 108	15,87 15,8 15,87 15,8 15,87 15,8 15,87 15,8
	140 160, CDI 170 CDI 190 210 Evolution	10.97-08.04 10.97-08.04 07.98-08.04 03.99-08.04 03.02-08.04	60 44/55/75 66/70 92 103			0 986 486 587 0 986 486 587 0 986 486 587 0 986 486 587 0 986 486 587	26 26 26 26 26
	140 160 160 CDI 170 CDI	10.97-08.04 10.97-08.04 09.00-08.04 10.97-08.04 03.01-08.04 09.98-02.01 03.01-08.04 07.98-02.01 03.01-08.04	60 75 60 75 44 55 66 70	Fg.-Nr. →J 016124 Fg.-Nr. →J 240914 Fg.-Nr. J 240915→J 546102 Fg.-Nr. J 546103→ Fg.-Nr. →J 016124 Fg.-Nr. J 181571→J 568589, Mod.Jahr 2000 Fg.-Nr. →J 016124 Fg.-Nr. →J 240914 Fg.-Nr. J 240915→J 546102 Fg.-Nr. J 546103→ Fg.-Nr. →J 240914 Fg.-Nr. J 240915→J 546102 Fg.-Nr. J 546103→ Fg.-Nr. →J 016124 Fg.-Nr. →J 240914 Fg.-Nr. J 240915→J 546102 Fg.-Nr. J 546103→ Fg.-Nr. →J 240914 Fg.-Nr. J 240915→J 546102		0 265 214 405 ^H 0 265 217 004 ^T 0 265 202 414 ^T 0 265 202 463 ^T 0 265 202 463 ^T 0 265 214 405 ^H 0 265 202 414 ^T 0 265 202 463 ^T 0 265 214 405 ^H 0 265 217 004 ^T 0 265 202 414 ^T 0 265 202 463 ^T 0 265 217 004 ^T 0 265 202 414 ^T 0 265 214 405 ^H 0 265 217 004 ^T 0 265 202 414 ^T 0 265 202 463 ^T 0 265 202 463 ^T 0 265 217 004 ^T 0 265 202 414 ^T	



		S				?			
◀ MERCEDES-BENZ Serie A [168]									
	190	03.99-08.04	92	Fg.-Nr. →J 016124			0 265 214 405 ^H		
				Fg.-Nr. →J 240914			0 265 217 004 ^T		
				Fg.-Nr. J 240915 →J 546102			0 265 202 414 ^T		
				Fg.-Nr. J 546103 →			0 265 202 463 ^T		
		03.01-08.04	92				0 265 202 463 ^T		
	210 Evolution	03.02-08.04	103				0 265 202 463 ^T		
	140	10.97-08.04	60	Fg.-Nr. →J 240914			0 265 109 459 ^M		
				Fg.-Nr. J 240915 →J 568589			0 265 109 477 ^M		
				Fg.-Nr. J 568590 →			0 265 109 630 ^M		
		09.00-08.04	60				0 265 109 630 ^M		
	160	10.97-08.04	75	Fg.-Nr. →J 240914			0 265 109 459 ^M		
				Fg.-Nr. J 240915 →J 568589			0 265 109 477 ^M		
				Fg.-Nr. J 568590 →			0 265 109 630 ^M		
		03.01-08.04	75				0 265 109 630 ^M		
	160 CDI	09.98-08.04	44/55	Fg.-Nr. →J 240914			0 265 109 459 ^M		
				Fg.-Nr. J 240915 →J 568589			0 265 109 477 ^M		
				Fg.-Nr. J 568590 →			0 265 109 630 ^M		
	170 CDI	07.98-02.01	66	Fg.-Nr. →J 240914			0 265 109 459 ^M		
				Fg.-Nr. J 240915 →J 568589			0 265 109 477 ^M		
				Fg.-Nr. J 568590 →			0 265 109 630 ^M		
		03.01-08.04	70				0 265 109 630 ^M		
	190	03.99-08.04	92	Fg.-Nr. →J 240914			0 265 109 459 ^M		
				Fg.-Nr. J 240915 →J 568589			0 265 109 477 ^M		
				Fg.-Nr. J 568590 →			0 265 109 630 ^M		
		03.01-08.04	92				0 265 109 630 ^M		
	210 Evolution	03.02-08.04	103				0 265 109 630 ^M		
	140	10.97-05.99	60				0 265 005 201		
		06.99-08.04	60				0 265 005 258		
	160	10.97-05.99	75				0 265 005 201		
		06.99-08.04	75				0 265 005 258		
	160 CDI	09.98-05.99	44				0 265 005 201		
		06.99-02.01	44				0 265 005 258		
		03.01-08.04	55				0 265 005 258		
	170 CDI	07.98-05.99	66				0 265 005 201		
		06.99-02.01	66				0 265 005 258		
		03.01-08.04	70				0 265 005 258		
	190	03.99-05.99	92				0 265 005 201		
		06.99-08.04	92				0 265 005 258		
	210 Evolution	03.02-08.04	103				0 265 005 258		
	140	10.97-08.04	60				0 265 005 303		
	160 CDI	10.97-08.04	44/55/75				0 265 005 303		
	170 CDI	07.98-08.04	66/70				0 265 005 303		
	190	03.99-08.04	92				0 265 005 303		
	210 Evolution	03.02-08.04	103				0 265 005 303		
Serie A [169]									
	150	09.04-06.07	70			TW	0 986 486 587	26	
	160 CDI	09.04-06.07	60	Get.-Nr. →..1201965,			0 986 486 587	26	
				Get.-Nr. ...1183411, Get.-Nr. ...1183412,					
				Get.-Nr. ...1183413, Get.-Nr. ...1183414,					
				Get.-Nr. ...1183415, Get.-Nr. ...1183416,					
				Get.-Nr. ...1183417, Get.-Nr. ...1442772					
	170	09.04-04.09	85				0 986 486 587	26	
	200	04.04-06.07	100	Get.-Nr. →..1183420			0 986 486 587	26	
	150	09.04-11.05	70	Fg.-Nr. →J 263173			0 265 234 044 ^T		
	160 CDI	09.04-11.05	60	Fg.-Nr. →J 263173			0 265 234 044 ^T		

		S							
170		09.04-11.05	85		Fg.-Nr. →J 263173		0 265 234 044 ^T		
180 CDI		09.04-11.05	80		Fg.-Nr. →J 263173		0 265 234 044 ^T		
200, CDI, Turbo		04.04-11.05	100/103/ 142		Fg.-Nr. →J 263173		0 265 234 044 ^T		
	E-Cell	01.11-04.12	50				0 265 005 727		
	150	09.04-04.09	70				0 265 005 753		
	160	04.09-04.12	70				0 265 005 727		
	160 CDI	09.04-05.08	60		Fg.-Nr. →J 625722, Mod.Jahr →2006		0 265 005 753		
		09.07-04.12	60		Fg.-Nr. J 530922→, Mod.Jahr 2007→		0 265 005 727		
	170	09.04-04.09	85				0 265 005 753		
	180	04.09-04.12	85				0 265 005 727		
	180 CDI	09.04-05.08	80		Fg.-Nr. →J 625722, Mod.Jahr →2006		0 265 005 753		
		09.07-04.12	80		Fg.-Nr. J 530922→, Mod.Jahr 2007→		0 265 005 727		
	200	04.04-05.08	100/103		Fg.-Nr. →J 625722, Mod.Jahr →2006		0 265 005 753		
	200 CDI	09.07-04.12	100/103		Fg.-Nr. J 530922→, Mod.Jahr 2007→		0 265 005 727		
	200 Turbo	06.05-10.10	142				0 265 005 753		
Serie B [245]									
									
	150	04.05-06.07	70			TW	0 986 486 587	26	
	170	04.05-06.07	85			TW	0 986 486 587	26	
	200	04.05-06.07	100		Get.-Nr. →..1183420		0 986 486 587	26	
	150	04.05-04.09	70		Fg.-Nr. →J 062950		0 265 234 044 ^T		
	170	04.05-11.05	85		Fg.-Nr. →J 062950		0 265 234 044 ^T		
	180 CDI	04.05-11.05	80		Fg.-Nr. →J 062950		0 265 234 044 ^T		
	200, CDI, Turbo	04.05-11.05	100-103/ 142		Fg.-Nr. →J 062950		0 265 234 044 ^T		
	150	04.05-05.08	70		Fg.-Nr. →J 384822, Mod.Jahr →2007		0 265 005 753		
		09.07-04.09	70		Fg.-Nr. J 297126→, Mod.Jahr 2008→		0 265 005 727		
	160	04.09-04.11	70				0 265 005 727		
	170	04.05-05.08	85		Fg.-Nr. →J 384822, Mod.Jahr →2007		0 265 005 753		
		09.07-04.09	85		Fg.-Nr. J 297126→, Mod.Jahr 2008→		0 265 005 727		
	170 NGT	05.08-04.09	85				0 265 005 727		
	180, NGT	04.09-04.11	85				0 265 005 727		
	180 CDI	04.05-05.08	80		Fg.-Nr. →J 384822, Mod.Jahr →2007		0 265 005 753		
		09.07-05.11	80		Fg.-Nr. J 297126→, Mod.Jahr 2008→		0 265 005 727		
	200	04.05-05.08	100-103/ 142		Fg.-Nr. →J 384822, Mod.Jahr →2007		0 265 005 753		
	200 CDI								
	200 Turbo	09.07-05.11	100-103/ 142		Fg.-Nr. J 297126→, Mod.Jahr 2008→		0 265 005 727		
Serie C (Coupé) [204]									
									
	63 AMG	06.11→	373/380				0 265 005 749		
Serie C (Sportcoupe) [203]									
									
	30 AMG CDI	09.02-08.04	170				0 986 486 064	19,05	
	160 KOMPRESSOR	06.05-02.08	90				0 986 486 064	19,05	
	180, KOMPRESSOR	01.01-02.08	95/105				0 986 486 064	19,05	
	200 CDI, CGI KOMPRESSOR, KOMPRESSOR	01.01-02.08	90/120/ 125				0 986 486 064	19,05	
	220 CDI	01.01-02.08	105/110				0 986 486 064	19,05	
	230, KOMPRESSOR	01.01-02.08	141/145/150				0 986 486 064	19,05	
	320	09.02-05.05	160				0 986 486 064	19,05	



		S				?			
	◀ MERCEDES-BENZ Serie C (Sportcoupe) [203]								
	350	06.05-02.08	200				0986 486 064	19,05	
	180	01.01-07.01	95	Fg.-Nr. →A 216386			0 265 202 451 ^M		
	200 KOMPRESSOR	01.01-08.02	120	Fg.-Nr. →A 216361, →F 161299, →R 033012			0 265 202 451 ^M		
	220 CDI	01.01-02.03	105	Fg.-Nr. →A 216361, →F 161299, →R 033012			0 265 202 451 ^M		
	230 KOMPRESSOR	01.01-07.01	145	Fg.-Nr. →A 216386			0 265 202 451 ^M		
Serie C (T-Modell) [202]									
	43 AMG	10.97-02.01	225	Fg.-Nr. →F 737081	JBH,LLE		0986 480 934		
	180	05.96-02.01	90	Fg.-Nr. →F 619720, Komp.Nr. Code 807, Komp.Nr. Code 808	JBH		0986 480 722	23,81	
				Fg.-Nr. F 619721→F 894083, Komp.Nr. Code 808/809, Komp.Nr. Code 800/807	JBH		0986 480 937	23,8	
	200	05.96-02.01	65/100/ 132/141	Fg.-Nr. →F 619720, Komp.Nr. Code 807, Komp.Nr. Code 808	JBH		0986 480 722	23,81	
	200 D			Fg.-Nr. F 619721→F 894083, Komp.Nr. Code 808/809, Komp.Nr. Code 800/807	JBH		0986 480 937		
	200 KOMPRESSOR		23,8						
	200 CDI	OFD 03.98-02.01	75		JBH		0986 480 937	23,8	
	220 CDI	12.97-02.01	92	Fg.-Nr. →F 619720, Komp.Nr. Code 807, Komp.Nr. Code 808	JBH		0986 480 722	23,81	
				Fg.-Nr. →F 894083, Komp.Nr. Code 809, Komp.Nr. Code 800	JBH		0986 480 937	23,8	
	220 D	05.96-06.99	55-70	Fg.-Nr. →F 619720, Komp.Nr. Code 807, Komp.Nr. Code 808	JBH		0986 480 722	23,81	
				Fg.-Nr. F 619721→F 894083, Komp.Nr. Code 808/809, Komp.Nr. Code 800/807	JBH		0986 480 937	23,8	
	230	05.96-05.97	110	Fg.-Nr. →F 619720, Komp.Nr. Code 807, Komp.Nr. Code 808	JBH		0986 480 722	23,81	
				Fg.-Nr. F 619721→F 894083, Komp.Nr. Code 808/809, Komp.Nr. Code 800/807	JBH		0986 480 937	23,8	
	230 KOMPRESSOR	06.97-02.01	142		JBH		0986 480 937	23,8	
	240	OFD 06.97-02.01	125		JBH		0986 480 937	23,8	
	250 D Turbo	05.96-02.01	110	Fg.-Nr. →F 619720, Komp.Nr. Code 807, Komp.Nr. Code 808	JBH		0986 480 722	23,81	
				Fg.-Nr. F 619721→F 894083, Komp.Nr. Code 808/809, Komp.Nr. Code 800/807	JBH		0986 480 937	23,8	
	280	OFD 06.97-02.01	145		JBH		0986 480 937	23,8	
	180	05.96-02.01	90				0986 486 043	19	
	200, CDI, D, KOMPRESSOR	05.96-02.01	65/75/100/132/141				0986 486 043	19	
	220 CDI, D	05.96-02.01	55-70/92				0986 486 043	19	
	230	05.96-05.97	110				0986 486 043	19	
	240	06.97-02.01	125				0986 486 043	19	
	250 D Turbo	05.96-02.01	110				0986 486 043	19	
	280	06.97-02.01	145				0986 486 043	19	
	180	05.96-02.01	90				0986 486 535	23,81	
	200, CDI, D, KOMPRESSOR	05.96-02.01	65/75/100/132/141				0986 486 535	23,81	



220 CDI, D	05.96-02.01	55-70/92		0 986 486 535	23,81
230	05.96-05.97	110		0 986 486 535	23,81
240	06.97-02.01	125		0 986 486 535	23,81
250 D Turbo	05.96-02.01	110		0 986 486 535	23,81
280	06.97-02.01	145		0 986 486 535	23,81

	43 AMG	10.97-02.01	225	Fg.-Nr. →A809594, →F894083, Komp.Nr. Code 809, Komp.Nr. Code 800	0 265 202 435 ^M
				Fg.-Nr. A809595→, F894084→, Komp.Nr. Code 800, Komp.Nr. Code 809	0 265 202 466 ^M
	180	05.96-02.01	90/95		0 265 202 451 ^M
	200, CDI, KOMPRESSOR	05.96-02.01	75/100/120/132/141		0 265 202 451 ^M
	220 CDI	12.97-02.01	92		0 265 202 451 ^M
	230 KOMPRESSOR	06.97-02.01	142		0 265 202 451 ^M
	240	06.97-02.01	125	Fg.-Nr. →F894083, Komp.Nr. Code 809, Komp.Nr. Code 800	0 265 202 435 ^M
				Fg.-Nr. F894084→, Komp.Nr. Code 809, Komp.Nr. Code 800	0 265 202 466 ^M
		08.00-02.01	125	Fg.-Nr. →F 980773	0 265 202 466 ^M
				Fg.-Nr. F980774→F998861, Komp.Nr. Code 801, Komp.Nr. Code 800	0 265 202 438 ^M
250 D Turbo	05.96-02.01	110		0 265 202 495 ^M	
280	06.97-02.01	145	Fg.-Nr. →F894083, Komp.Nr. Code 809, Komp.Nr. Code 800	0 265 202 451 ^M	
			Fg.-Nr. F894084→F980773, Komp.Nr. Code 800, Komp.Nr. Code 801/809	0 265 202 466 ^M	
			Fg.-Nr. F980774→F998861, Komp.Nr. Code 801, Komp.Nr. Code 800	0 265 202 438 ^M	
			Fg.-Nr. F998862→	0 265 202 495 ^M	

	43 AMG	10.97-02.01	225	Fg.-Nr. A809595→, F894084→	0 265 109 483 ^M
				Fg.-Nr. 202.A/B/C/D/E MET	0 265 109 053 ^K
	240	02.99-02.01	125	Fg.-Nr. →F980773	0 265 109 482 ^M
280	02.99-02.01	145	Fg.-Nr. →F980773	0 265 109 482 ^M	

	43 AMG	10.97-02.01	225		0 265 005 201
	240	06.97-02.01	125		0 265 005 201
	280	06.97-02.01	145		0 265 005 201









	43 AMG	10.97-02.01	225	Fg.-Nr. F 984084→	0 265 005 307
	180	05.96-02.01	90	Fg.-Nr. F 984084→	0 265 005 307
	200, CDI	05.96-02.01	75/100	Fg.-Nr. F 984084→	0 265 005 307
	220 CDI	12.97-02.01	92	Fg.-Nr. F 984084→	0 265 005 307
	230 KOMPRESSOR	06.97-02.01	142	Fg.-Nr. F 984084→	0 265 005 307
	240	06.97-02.01	125	Fg.-Nr. F 984084→	0 265 005 307
	250 D Turbo	05.96-02.01	110	Fg.-Nr. F 984084→	0 265 005 307
	280	06.97-02.01	145	Fg.-Nr. F 984084→	0 265 005 307

Serie C (T-Modell) [203]

	30 AMG CDI	01.03-08.04	170		0 986 486 064	19,05
	32 AMG KOMPRESSOR	01.01-01.04	260		0 986 486 064	19,05
	55 AMG	02.04-08.07	270		0 986 486 064	19,05
	180, KOMPRESSOR	01.01-08.07	95/105		0 986 486 064	19,05
	200 CDI, CGI KOMPRESSOR, KOMPRESSOR	01.01-08.07	75/85/90/ 120/125		0 986 486 064	19,05
	220 CDI	01.01-08.07	105/110		0 986 486 064	19,05
	230, KOMPRESSOR	02.04-08.07	141/150		0 986 486 064	19,05
	240, 4MATIC	01.01-06.05	125		0 986 486 064	19,05
	270 CDI	01.01-08.04	125		0 986 486 064	19,05



		S							
◀ MERCEDES-BENZ Serie C (T-Modell) [203]									
	280, 4MATIC	06.05-08.07	170				0 986 486 064	19,05	
	320, CDI, 4MATIC	01.01-08.07	160/165				0 986 486 064	19,05	
	350, 4MATIC	06.05-08.07	200				0 986 486 064	19,05	
	32 AMG KOMPRESSOR	01.01-01.04	260	Fg.-Nr. →A 216361, →F 161299, →R 033012			0 265 202 451 ^M		
	180	01.01-08.02	95	Fg.-Nr. →A 216361, →F 161299, →R 033012			0 265 202 451 ^M		
	200 CDI, KOMPRESSOR	01.01-05.03	85/120	Fg.-Nr. →A 216361, →F 161299, →R 033012			0 265 202 451 ^M		
	220 CDI	01.01-02.03	105	Fg.-Nr. →A 216361, →F 161299, →R 033012			0 265 202 451 ^M		
	240	01.01-05.05	125	Fg.-Nr. →A 216361, →F 161299, →R 033012			0 265 202 451 ^M		
	270 CDI	01.01-08.04	125	Fg.-Nr. →A 216361, →F 161299, →R 033012			0 265 202 451 ^M		
	320	01.01-05.05	160	Fg.-Nr. →A 216361, →F 161299, →R 033012			0 265 202 451 ^M		
	32 AMG KOMPRESSOR	01.01-01.04	260	Fg.-Nr. →A 216361/F 161299			0 265 005 307		
	180	01.01-08.02	95	Fg.-Nr. →A 216361/F 161299			0 265 005 307		
	200 CDI, KOMPRESSOR	01.01-05.03	85/120	Fg.-Nr. →A 216361/F 161299			0 265 005 307		
	220 CDI	01.01-02.03	105	Fg.-Nr. →A 216361/F 161299			0 265 005 307		
	240	01.01-05.05	125	Fg.-Nr. →A 216361/F 161299			0 265 005 307		
	270 CDI	01.01-08.04	125	Fg.-Nr. →A 216361/F 161299			0 265 005 307		
Serie C [202]									
	36 AMG	01.94-05.97	206	Fg.-Nr. →A 136773, →F 110261	JBH		0 986 480 020	19,05	
				Fg.-Nr. A 136774 →, F 110262 →	JBH		0 986 480 722	23,81	
	43 AMG	11.97-04.00	225	Fg.-Nr. →F 737081	JBH, LLE		0 986 480 934		
	180	03.93-04.00	90	Fg.-Nr. →A 021676, →F 011179	JBH		0 986 480 351	22,22	
				Fg.-Nr. A 021677 →A 136773, F 011180 →F 110261	JBH		0 986 480 020	19,05	
				Fg.-Nr. A 136774 →A 519673, F 110262 →F 619720, Komp.Nr. Code 807, Komp.Nr. Code 808	JBH		0 986 480 722	23,81	
		OFD 03.93-04.00	90	Fg.-Nr. A 519674 →A 809594, F 619721 →F 894083, Komp.Nr. Code 808/809, Komp.Nr. Code 800/807	JBH		0 986 480 937	23,8	
	200	01.94-04.00	100	Fg.-Nr. A 021677 →A 136773, F 011180 →F 110261	JBH		0 986 480 020	19,05	
				Fg.-Nr. A 136774 →A 519673, F 110262 →F 619720, Komp.Nr. Code 807, Komp.Nr. Code 808	JBH		0 986 480 722	23,81	
		OFD 01.94-04.00	100	Fg.-Nr. A 519674 →A 809594, F 619721 →F 894083, Komp.Nr. Code 808/809, Komp.Nr. Code 800/807	JBH		0 986 480 937	23,8	
	200 CDI	03.98-04.00	75	Fg.-Nr. →A 519673, →F 619720, Komp.Nr. Code 807, Komp.Nr. Code 808	JBH		0 986 480 722	23,81	
				Fg.-Nr. →A 809594, →F 894083, Komp.Nr. Code 808/809, Komp.Nr. Code 800/807	JBH		0 986 480 937	23,8	
	200 D	03.93-08.95	55	Fg.-Nr. →A 136773, →F 110261	JBH		0 986 480 020	19,05	
				Fg.-Nr. A 136774 →, F 110262 →	JBH		0 986 480 722	23,81	

		S							
200 D		09.96-06.99	55-65	Fg.-Nr. →A 519673, →F 619720, Komp.Nr. Code 807, Komp.Nr. Code 808	JBH		0 986 480 722		23,81
				Fg.-Nr. A 519674→, F 619721→, Komp.Nr. Code 808/809, Komp.Nr. Code 800/807			JBH		0 986 480 937
200 KOMPRESSOR		09.95-04.00	132-141	Fg.-Nr. →A 519673, →F 619720, Komp.Nr. Code 807, Komp.Nr. Code 808	JBH		0 986 480 722		23,81
				Fg.-Nr. →A 809594, →F 894083, Komp.Nr. Code 808/809, Komp.Nr. Code 800/807			JBH		0 986 480 937
220		03.93-09.96	110	Fg.-Nr. →A 136773, →F 110261	JBH		0 986 480 020		19,05
		MFD 03.93-09.96	110	Fg.-Nr. A 136774→, F 110262→			JBH		0 986 480 722
220 CDI		12.97-04.00	92	Fg.-Nr. →A 519673, →F 619720, Komp.Nr. Code 807, Komp.Nr. Code 808	JBH		0 986 480 722		23,81
				Fg.-Nr. →A 809594, →F 894083, Komp.Nr. Code 808/809, Komp.Nr. Code 800/807			JBH		0 986 480 937
220 D		08.93-06.99	55-70	Fg.-Nr. →A 072907, →F 060569	JBH		0 986 480 351		22,22
				Fg.-Nr. →A 809594, →F 894083, Komp.Nr. Code 808/809, Komp.Nr. Code 800/807			JBH		0 986 480 937
				Fg.-Nr. A 072908→A 136773, F 060570→F 110261	JBH	0 986 480 020	19,05		
				Fg.-Nr. A 136774→A 519673, F 110262→F 619720, Komp.Nr. Code 807, Komp.Nr. Code 808	JBH	0 986 480 722	23,81		
230		09.96-08.98	110	Fg.-Nr. →A 519673, →F 619720, Komp.Nr. Code 807, Komp.Nr. Code 808	JBH		0 986 480 722		23,81
				Fg.-Nr. A 519674→, F 619721→, Komp.Nr. Code 808/809, Komp.Nr. Code 800/807			JBH		0 986 480 937
230 KOMPRESSOR		09.95-04.00	142	Fg.-Nr. →A 519673, →F 619720, Komp.Nr. Code 807, Komp.Nr. Code 808	JBH		0 986 480 722		23,81
		OFD 09.95-04.00	142	Fg.-Nr. A 519674→A 809594, F 619721→F 894083, Komp.Nr. Code 808/809, Komp.Nr. Code 800/807			JBH		0 986 480 937
240		OFD 06.97-04.00	125		JBH		0 986 480 937		23,8
250 D		05.93-08.95	83	Fg.-Nr. →A 072907, →F 060569	JBH		0 986 480 351		22,22
				Fg.-Nr. A 072908→A 136773, F 060570→F 110261			JBH		0 986 480 020
				Fg.-Nr. A 136774→, F 110262→	JBH	0 986 480 722	23,81		



		S							
◀ MERCEDES-BENZ Serie C [202]									
250 D Turbo	09.95-04.00	110	Fg.-Nr. →A 519673, →F 619720, Komp.Nr. Code 807, Komp.Nr. Code 808	JBH		0 986 480 722	23,81		
			Fg.-Nr. →A 809594, →F 894083, Komp.Nr. Code 808/809, Komp.Nr. Code 800/807	JBH		0 986 480 937	23,8		
280	05.93-05.97	142	Fg.-Nr. A 136774→, F 110262→	JBH		0 986 480 722	23,81		
	OFD 06.97-08.00	145		JBH		0 986 480 937	23,8		
36 AMG	01.94-05.97	206				0 986 486 043	19		
180	03.93-08.95	90				0 986 486 043	19		
200, CDI, D, KOMPRESSOR	03.93-04.00	55-65/75/100/132-141				0 986 486 043	19		
220, CDI, D	03.93-04.00	55-70/92/110				0 986 486 043	19		
230, KOMPRESSOR	09.95-04.00	110/142				0 986 486 043	19		
240	06.97-04.00	125				0 986 486 043	19		
250 D, D Turbo	05.93-04.00	83/110				0 986 486 043	19		
280	05.93-04.00	142/145				0 986 486 043	19		
36 AMG	01.94-05.97	206				0 986 486 535	23,81		
180	03.93-04.00	90				0 986 486 535	23,81		
200, CDI, D, KOMPRESSOR	01.94-04.00	55-65/75/100/132-141				0 986 486 535	23,81		
200 D	03.93-08.95	55	Mot.-Nr. →601.913 0 007297 Mot.-Nr. 601.913 0 007298→			0 986 486 503	23,81		
						0 986 486 535	23,81		
220	03.93-09.96	110				0 986 486 535	23,81		
220 CDI	12.97-04.00	92				0 986 486 535	23,81		
220 D	08.93-06.99	55-70	Mot.-Nr. →604.910 0 000545 Mot.-Nr. 604.910 0 000546→			0 986 486 503	23,81		
						0 986 486 535	23,81		
230, KOMPRESSOR	09.95-04.00	110/142				0 986 486 535	23,81		
240	06.97-04.00	125				0 986 486 535	23,81		
250 D, D Turbo	05.93-04.00	83/110				0 986 486 535	23,81		
280	05.93-08.00	142/145				0 986 486 535	23,81		
36 AMG	01.94-05.97	206	Fg.-Nr. →A344660, →F331440, Komp.Nr. Code 805, Komp.Nr. Code 806	BO		0 265 200 027 ^H			
			Fg.-Nr. A136774→A344660, F110262→F331440			0 265 217 004 ^J			
			Fg.-Nr. A344661→, F331441→			0 265 217 008 ^J			
			Fg.-Nr. A344661→, F331441→, Komp.Nr. Code 806, Komp.Nr. Code 805	BO		0 265 213 009 ^H			
43 AMG	11.97-04.00	225	Fg.-Nr. →A809594, →F894083, Komp.Nr. Code 809, Komp.Nr. Code 800			0 265 202 435 ^M			
			Fg.-Nr. A809595→, F894084→, Komp.Nr. Code 800, Komp.Nr. Code 809			0 265 202 466 ^M			
180	03.93-04.00	90				0 265 202 451 ^M			
						0 265 217 403 ^J			
			Fg.-Nr. →A344660, →F331440, Komp.Nr. Code 805, Komp.Nr. Code 806	BO		0 265 200 027 ^H			
			Fg.-Nr. A136774→A344660, F110262→F331440			0 265 217 004 ^J			
			Fg.-Nr. A344661→, F331441→			0 265 217 008 ^J			
			Fg.-Nr. A344661→A519673, F331441→F619720, Komp.Nr. Code 806/807, Komp.Nr. Code 805/808	BO		0 265 213 009 ^H			
			Fg.-Nr. A519674→, F619721→, Komp.Nr. Code 808, Komp.Nr. Code 807/809	BO		0 265 213 403 ^H			
200	01.94-04.00	100				0 265 202 451 ^M			
						0 265 217 403 ^J			

		S							
200		01.94-04.00	100	Fg.-Nr. →A344660, →F331440, Komp.Nr. Code 805, Komp.Nr. Code 806	BO		0 265 200 027 ^H		
				Fg.-Nr. A136774→A344660, F110262→F331440			0 265 217 004 ^J		
				Fg.-Nr. A344661→, F331441→			0 265 217 008 ^J		
				Fg.-Nr. A344661→, F331441→, Komp.Nr. Code 806, Komp.Nr. Code 805	BO		0 265 213 009 ^H		
200 CDI		03.98-04.00	75				0 265 202 451 ^M		
							0 265 217 403 ^J		
					BO		0 265 213 403 ^H		
200 D		03.93-08.95	55				0 265 200 027 ^H		
				Fg.-Nr. A136774→A344660, F110262→F331440			0 265 217 004 ^J		
				Fg.-Nr. A344661→, F331441→			0 265 217 008 ^J		
		09.96-06.99	55-65				0 265 217 403 ^J		
				Fg.-Nr. →A519673, →F619720			0 265 217 008 ^J		
				Fg.-Nr. →A519673, →F619720, Komp.Nr. Code 806/807, Komp.Nr. Code 805/808	BO		0 265 213 009 ^H		
200 KOMPRESSOR		09.95-04.00	132-141				0 265 202 451 ^M		
220		03.93-09.96	110	Fg.-Nr. →A344660, →F331440, Komp.Nr. Code 805, Komp.Nr. Code 806	BO		0 265 200 027 ^H		
				Fg.-Nr. A136774→A344660, F110262→F331440			0 265 217 004 ^J		
				Fg.-Nr. A344661→, F331441→			0 265 217 008 ^J		
				Fg.-Nr. A344661→, F331441→, Komp.Nr. Code 806, Komp.Nr. Code 805	BO		0 265 213 009 ^H		
220 CDI		12.97-04.00	92				0 265 202 451 ^M		
							0 265 217 403 ^J		
					BO		0 265 213 403 ^H		
220 D		08.93-06.99	55-70				0 265 217 403 ^J		
				Fg.-Nr. →A344660, →F331440			0 265 217 004 ^J		
				Fg.-Nr. →A344660, →F331440, Komp.Nr. Code 805, Komp.Nr. Code 806	BO		0 265 200 027 ^H		
				Fg.-Nr. A344661→A519673, F331441→F619720			0 265 217 008 ^J		
				Fg.-Nr. A344661→A519673, F331441→F619720, Komp.Nr. Code 806/807, Komp.Nr. Code 805/808	BO		0 265 213 009 ^H		
				Fg.-Nr. A519674→, F619721→, Komp.Nr. Code 808, Komp.Nr. Code 807/809	BO		0 265 213 403 ^H		
230		09.96-08.98	110				0 265 217 008 ^J		
					BO		0 265 213 009 ^H		
230 KOMPRESSOR		09.95-04.00	142				0 265 202 451 ^M		
240		06.97-04.00	125				0 265 217 403 ^J		
				Fg.-Nr. →A809594, →F894083, Komp.Nr. Code 809, Komp.Nr. Code 800			0 265 202 435 ^M		
				Fg.-Nr. A809595→, F894084→, Komp.Nr. Code 800, Komp.Nr. Code 809			0 265 202 466 ^M		
250 D		05.93-08.95	83	Fg.-Nr. →A344660, →F331440, Komp.Nr. Code 805, Komp.Nr. Code 806	BO		0 265 200 027 ^H		
				Fg.-Nr. A136774→A344660, F110262→F331440			0 265 217 004 ^J		
				Fg.-Nr. A344661→, F331441→			0 265 217 008 ^J		
250 D Turbo		09.95-04.00	110				0 265 202 451 ^M		
							0 265 213 009 ^H		
							0 265 217 008 ^J		
							0 265 217 403 ^J		
280		05.93-05.97	142	Fg.-Nr. →A344660, →F331440, Komp.Nr. Code 805, Komp.Nr. Code 806	BO		0 265 200 027 ^H		



◀ MERCEDES-BENZ Serie C [202]											
280	05.93-05.97	142	Fg.-Nr. A136774→A344660, F110262→F331440				0 265 217 004 ^J				
			Fg.-Nr. A344661→, F331441→				0 265 217 008 ^J				
			Fg.-Nr. A344661→, F331441→, Komp.Nr. Code 806, Komp.Nr. Code 805				BO	0 265 213 009 ^H			
	06.97-08.00	145	Fg.-Nr. →A809594, →F894083, Komp.Nr. Code 809, Komp.Nr. Code 800				0 265 217 403 ^J				
			Fg.-Nr. A809595→, F894084→, Komp.Nr. Code 800, Komp.Nr. Code 809				0 265 202 435 ^M				
			Fg.-Nr. A809595→, F894084→, Komp.Nr. Code 800, Komp.Nr. Code 809				0 265 202 466 ^M				
36 AMG	01.94-05.97	206	Fg.-Nr. →A344660, →F331440, Komp.Nr. Code 805, Komp.Nr. Code 806				0 265 101 041 ^H				
			Fg.-Nr. A344661→, F331441→, Komp.Nr. Code 806, Komp.Nr. Code 805				BO	0 265 108 018 ^H			
			Fg.-Nr. A436536→, F483848→, Komp.Nr. Code 807, Komp.Nr. Code 806				PRG BO	0 265 109 053 ^K			
	09.95-09.96	206	Fg.-Nr. 202.A/B/C/D/E MET				0 265 109 053 ^K				
			Fg.-Nr. 202.A/B/C/D/E MET				0 265 109 053 ^J				
			Fg.-Nr. 202.A/B/C/D/E MET				PRG BO	0 265 109 053 ^K			
43 AMG	11.97-04.00	225	Fg.-Nr. A809595→, F894084→ Fg.-Nr. 202.A/B/C/D/E MET				0 265 109 053 ^K				
			Fg.-Nr. A809595→, F894084→ Fg.-Nr. 202.A/B/C/D/E MET				0 265 109 483 ^M				
			Fg.-Nr. 202.A/B/C/D/E MET				0 265 109 053 ^K				
	180	03.93-04.00	90	Fg.-Nr. →A344660, →F331440, Komp.Nr. Code 805, Komp.Nr. Code 806				0 265 101 041 ^H			
				Fg.-Nr. A344661→, F331441→, Komp.Nr. Code 806, Komp.Nr. Code 805				BO	0 265 108 018 ^H		
				Fg.-Nr. A344661→A436535, F331441→F483847, Komp.Nr. Code 806, Komp.Nr. Code 805				BO	0 265 108 018 ^H		
09.95-04.00		90	Fg.-Nr. A436536→, F483848→, Komp.Nr. Code 807, Komp.Nr. Code 806				PRG BO	0 265 109 053 ^K			
			Fg.-Nr. A436536→, F483848→, Komp.Nr. Code 807, Komp.Nr. Code 806				BO	0 265 108 029 ^H			
			Fg.-Nr. 202.A/B/C/D/E GRA				BO	0 265 109 052 ^J			
200	01.94-04.00	100	Fg.-Nr. →A344660, →F331440, Komp.Nr. Code 805, Komp.Nr. Code 806				0 265 101 041 ^H				
			Fg.-Nr. A344661→, F331441→, Komp.Nr. Code 806, Komp.Nr. Code 805				BO	0 265 108 018 ^H			
			Fg.-Nr. A436536→, F483848→, Komp.Nr. Code 807, Komp.Nr. Code 806				PRG BO	0 265 109 053 ^K			
	09.95-04.00	90	Fg.-Nr. 202.A/B/C/D/E MET				0 265 109 053 ^K				
			Fg.-Nr. 202.A/B/C/D/E MET				0 265 109 053 ^J				
			Fg.-Nr. 202.A/B/C/D/E MET				GRA BO	0 265 109 052 ^J			
200 CDI	03.98-04.00	75	Fg.-Nr. 202.A/B/C/D/E GRA				BO	0 265 109 053 ^K			
			Fg.-Nr. 202.A/B/C/D/E GRA				BO	0 265 109 052 ^J			
			Fg.-Nr. 202.A/B/C/D/E MET				0 265 109 053 ^K				
200 D	03.93-08.95	55	Fg.-Nr. →A344660, →F331440, Komp.Nr. Code 805, Komp.Nr. Code 806				0 265 101 041 ^H				
			Fg.-Nr. A344661→, F331441→, Komp.Nr. Code 806, Komp.Nr. Code 805				BO	0 265 108 018 ^H			
			Fg.-Nr. A436536→, F483848→, Komp.Nr. Code 807, Komp.Nr. Code 806				PRG BO	0 265 109 053 ^K			
	03.93-08.95	55	Fg.-Nr. 202.A/B/C/D/E GRA				BO	0 265 109 052 ^J			
			Fg.-Nr. 202.A/B/C/D/E MET				0 265 109 053 ^K				
			Fg.-Nr. 202.A/B/C/D/E MET				0 265 109 053 ^K				

		S								
200 D	09.96-06.99	55-65	Fg.-Nr. →A344660, →F331440, Komp.Nr. Code 805, Komp.Nr. Code 806						0 265 101 041 ^H	
				Fg.-Nr. A344661→, F331441→, Komp.Nr. Code 806, Komp.Nr. Code 805	BO				0 265 108 018 ^H	
				Fg.-Nr. A344661→A436535, F331441→F483847, Komp.Nr. Code 806, Komp.Nr. Code 805	BO				0 265 108 018 ^H	
				Fg.-Nr. A436536→, F483848→, Komp.Nr. Code 807, Komp.Nr. Code 806	PRG	BO			0 265 109 053 ^K	
				Fg.-Nr. A436536→, F483848→, Komp.Nr. Code 807, Komp.Nr. Code 806	BO				0 265 108 029 ^H	
				Fg.-Nr. 202.A/B/C/D/E	GRA	BO			0 265 109 052 ^J	
					MET				0 265 109 053 ^K	
200 KOMPRESSOR	09.95-04.00	132-141	Fg.-Nr. A436536→, F483848→, Komp.Nr. Code 807, Komp.Nr. Code 806					BO	0 265 108 018 ^H	
				Fg.-Nr. 202.A/B/C/D/E	GRA	BO			0 265 109 052 ^J	
					MET				0 265 109 053 ^K	
220	03.93-08.95	110						KTS	0 265 106 113 ^K	
				03.93-09.96	110	Fg.-Nr. →A344660, →F331440, Komp.Nr. Code 805, Komp.Nr. Code 806				0 265 101 041 ^H
				Fg.-Nr. A344661→, F331441→, Komp.Nr. Code 806, Komp.Nr. Code 805	BO			0 265 108 018 ^H		
				Fg.-Nr. A436536→, F483848→, Komp.Nr. Code 807, Komp.Nr. Code 806	PRG	BO		0 265 109 053 ^K		
				Fg.-Nr. 202.A/B/C/D/E	GRA	BO		0 265 109 052 ^J		
				MET			0 265 109 053 ^K			
220 CDI	12.97-04.00	92	Fg.-Nr. 202.A/B/C/D/E					PRG	BO	0 265 109 053 ^K
					GRA	BO			0 265 109 052 ^J	
				MET				0 265 109 053 ^K		
220 D	08.93-06.99	55-70	Fg.-Nr. →A344660, →F331440, Komp.Nr. Code 805, Komp.Nr. Code 806						0 265 101 041 ^H	
				Fg.-Nr. A344661→, F331441→, Komp.Nr. Code 806, Komp.Nr. Code 805	BO				0 265 108 018 ^H	
				Fg.-Nr. A344661→A436535, F331441→F483847, Komp.Nr. Code 806, Komp.Nr. Code 805	BO				0 265 108 018 ^H	
				Fg.-Nr. A436536→, F483848→, Komp.Nr. Code 807, Komp.Nr. Code 806	PRG	BO			0 265 109 053 ^K	
				Fg.-Nr. A436536→, F483848→, Komp.Nr. Code 807, Komp.Nr. Code 806	BO				0 265 108 029 ^H	
				Fg.-Nr. 202.A/B/C/D/E	GRA	BO			0 265 109 052 ^J	
					MET				0 265 109 053 ^K	
										BO
230 230 KOMPRESSOR	09.95-04.00	110/142	Fg.-Nr. A436536→, F483848→, Komp.Nr. Code 807, Komp.Nr. Code 806					PRG	BO	0 265 109 053 ^K
				Fg.-Nr. 202.A/B/C/D/E	GRA	BO			0 265 109 052 ^J	
					MET				0 265 109 053 ^K	
240	06.97-04.00	125	Fg.-Nr. F894084→ Fg.-Nr. 202.A/B/C/D/E					PRG	BO	0 265 109 053 ^K
					GRA	BO			0 265 109 052 ^J	
250 D	05.93-08.95	83	Fg.-Nr. →A344660, →F331440, Komp.Nr. Code 805, Komp.Nr. Code 806						0 265 101 041 ^H	



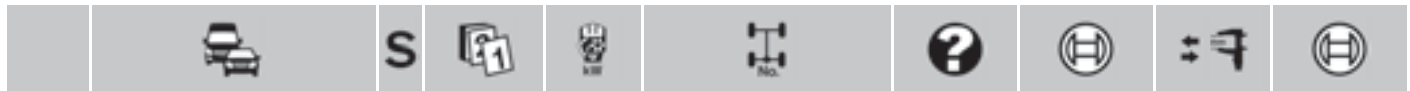

◀ MERCEDES-BENZ Serie C [202]

250 D	05.93-08.95	83	Fg.-Nr. A344661→, F331441→, Komp.Nr. Code 806, Komp.Nr. Code 805	BO	0 265 108 018^H
			Fg.-Nr. A436536→, PRG BO F483848→, Komp.Nr. Code 807, Komp.Nr. Code 806		0 265 109 053^K
250 D Turbo	09.95-04.00	110	Fg.-Nr. 202.A/B/C/D/E	MET	0 265 109 053^K
			Fg.-Nr. A436536→, PRG BO F483848→, Komp.Nr. Code 807, Komp.Nr. Code 806		0 265 108 018^H
280	05.93-05.97	142	Fg.-Nr. →A344660, →F331440, Komp.Nr. Code 805, Komp.Nr. Code 806		0 265 101 041^H
			Fg.-Nr. A344661→, F331441→, Komp.Nr. Code 806, Komp.Nr. Code 805	BO	0 265 108 018^H
			Fg.-Nr. A436536→, PRG BO F483848→, Komp.Nr. Code 807, Komp.Nr. Code 806		0 265 109 053^K
			Fg.-Nr. 202.A/B/C/D/E	GRA BO	0 265 109 052^J
				MET	0 265 109 053^K
	06.97-08.00	145	Fg.-Nr. F894084→	PRG BO	0 265 109 482^M
			Fg.-Nr. 202.A/B/C/D/E	GRA BO	0 265 109 052^J
				MET	0 265 109 053^K

	43 AMG	11.97-04.00	225		0 265 005 201
	240	06.97-04.00	125		0 265 005 201
	280	06.97-08.00	145		0 265 005 201

	43 AMG	11.97-04.00	225	Fg.-Nr. A 809595→, F 894084→	0 265 005 307
	180	03.93-04.00	90	Fg.-Nr. A 809595→, F 894084→	0 265 005 307
	200, CDI, KOMPRESSOR	01.94-04.00	75/100/ 132-141	Fg.-Nr. A 809595→, F 894084→	0 265 005 307
	220 CDI	12.97-04.00	92	Fg.-Nr. A 809595→, F 894084→	0 265 005 307
	230 KOMPRESSOR	09.95-04.00	142	Fg.-Nr. A 809595→, F 894084→	0 265 005 307
	240	06.97-04.00	125	Fg.-Nr. A 809595→, F 894084→	0 265 005 307
	250 D Turbo	09.95-04.00	110	Fg.-Nr. A 809595→, F 894084→	0 265 005 307
	280	06.97-04.00	145	Fg.-Nr. A 809595→, F 894084→	0 265 005 307

Serie C [203]



	30 AMG CDI	01.03-08.04	170		0 986 486 064	19,05
	32 AMG KOMPRESSOR	01.01-01.04	260		0 986 486 064	19,05
	55 AMG	02.04-08.07	270		0 986 486 064	19,05
	180, KOMPRESSOR	10.00-07.07	95/105		0 986 486 064	19,05
	200 CDI, CGI KOMPRESSOR, KOMPRESSOR	05.00-07.07	75/85/90/ 120/125		0 986 486 064	19,05
	220 CDI	05.00-02.07	100-110		0 986 486 064	19,05
	230, KOMPRESSOR	02.04-07.07	141/150		0 986 486 064	19,05
	240, 4MATIC	05.00-06.05	125		0 986 486 064	19,05
	270 CDI	12.00-08.04	125		0 986 486 064	19,05
	280, 4MATIC	09.05-08.07	170		0 986 486 064	19,05
	320, CDI, 4MATIC	05.00-05.07	160/165		0 986 486 064	19,05
	350, 4MATIC	06.05-08.07	200		0 986 486 064	19,05

	32 AMG KOMPRESSOR	01.01-01.04	260	Fg.-Nr. →A 216361, →F 161299, →R 033012	0 265 202 451^M
	180	10.00-08.02	95	Fg.-Nr. →A 216361, →F 161299, →R 033012	0 265 202 451^M

		S							
200 CDI, KOMPRESSOR		05.00-05.03	85/120		Fg.-Nr. →A 216361, →F 161299, →R 033012		0 265 202 451 ^M		
220 CDI		05.00-02.03	100-105		Fg.-Nr. →A 216361, →F 161299, →R 033012		0 265 202 451 ^M		
240		05.00-05.05	125		Fg.-Nr. →A 216361, →F 161299, →R 033012		0 265 202 451 ^M		
270 CDI		12.00-08.04	125		Fg.-Nr. →A 216361, →F 161299, →R 033012		0 265 202 451 ^M		
320		05.00-05.05	160		Fg.-Nr. →E 005178, →A 216386, →F 161299, →R 034587		0 265 202 451 ^M		
32 AMG KOMPRESSOR		01.01-01.04	260		Fg.-Nr. →A 216361/F 161299		0 265 005 307		
180		10.00-08.02	95		Fg.-Nr. →A 216361/F 161299		0 265 005 307		
200 CDI, KOMPRESSOR		05.00-05.03	85/120		Fg.-Nr. →A 216361/F 161299		0 265 005 307		
220 CDI		05.00-02.03	100-105		Fg.-Nr. →A 216361/F 161299		0 265 005 307		
240		05.00-05.05	125		Fg.-Nr. →A 216361/F 161299		0 265 005 307		
270 CDI		12.00-08.04	125		Fg.-Nr. →A 216361/F 161299		0 265 005 307		
320		05.00-05.05	160		Fg.-Nr. →A 216361/F 161299		0 265 005 307		
Serie CL (Coupé) [140]									
500		06.96-08.99	235		Fg.-Nr. →A 110606	LLE	0 986 480 896	26	
600		06.96-08.99	290		Fg.-Nr. →A 110606	LLE	0 986 480 896	26	
420		06.96-08.99	205				0 265 202 022 ^M		
							0 265 202 023 ^M		
							0 265 202 110 ^Q		
					Fg.-Nr. →A212244		0 265 217 008 ^J		
					Fg.-Nr. A212245→		0 265 217 004 ^J		
500		06.96-08.99	235				0 265 200 027 ^H		
							0 265 202 022 ^M		
							0 265 202 023 ^M		
							0 265 202 110 ^Q		
					Fg.-Nr. →A212244		0 265 217 008 ^J		
					Fg.-Nr. A212245→		0 265 217 004 ^J		
600		06.96-08.99	290				0 265 202 022 ^M		
							0 265 202 023 ^M		
							0 265 202 110 ^Q		
					Fg.-Nr. A 187334→, Komp.Nr. 867		0 265 217 004 ^J		
420		06.96-08.99	205				0 265 109 071 ^M		
500		06.96-08.99	235				0 265 101 047 ^H		
							0 265 109 071 ^M		
					Fg.-Nr. →A212244, Komp.Nr. Code 867		0 265 106 071 ^J		
600		06.96-08.99	290				0 265 109 071 ^M		
					Fg.-Nr. →A212244, Komp.Nr. Code 867		0 265 106 071 ^J		
420		06.96-08.99	205				0 265 005 201		
500		06.96-08.99	235				0 265 005 201		
600		06.96-08.99	290				0 265 005 201		
420		06.96-08.99	205				0 265 005 300		
500		06.96-08.99	235				0 265 005 300		
600		06.96-08.99	290				0 265 005 300		
Serie CL (Coupé) [215]									
55 AMG, KOMPRESSOR		09.99-08.06	265/368				0 265 202 446 ^M		
65 AMG		09.03-08.06	450				0 265 202 446 ^M		
500		09.99-05.06	225				0 265 202 446 ^M		
600		09.99-08.06	270/368				0 265 202 446 ^M		
55 AMG		09.99-08.06	265/368		Fg.-Nr. →A 008782		0 265 109 492 ^M		
55 AMG KOMPRESSOR					Fg.-Nr. A 008783→A 032099		0 265 109 497 ^M		
					Fg.-Nr. A 032100→		0 265 109 745 ^M		



		S							
	◀ MERCEDES-BENZ Serie CL (Coupé) [215]								
	65 AMG	09.03-08.06	450				0 265 109 746 ^M		
	500	09.99-05.06	225	Fg.-Nr. →A 008782			0 265 109 492 ^M		
				Fg.-Nr. A 008783→A 032099			0 265 109 497 ^M		
				Fg.-Nr. A 032100→			0 265 109 745 ^M		
	600	09.99-08.06	270/368	Fg.-Nr. →A 008782			0 265 109 492 ^M		
				Fg.-Nr. A 008783→A 032099			0 265 109 497 ^M		
				Fg.-Nr. A 032100→			0 265 109 745 ^M		
	55 AMG, KOMPRESSOR	09.99-08.06	265/368				0 265 005 258		
	65 AMG	09.03-08.06	450				0 265 005 258		
	500	09.99-05.06	225				0 265 005 258		
	600	09.99-08.06	270/368				0 265 005 258		
	55 AMG, KOMPRESSOR	09.99-08.06	265/368				0 265 005 303		
	65 AMG	09.03-08.06	450				0 265 005 303		
	500	09.99-05.06	225				0 265 005 303		
	600	09.99-08.06	270/368				0 265 005 303		
Serie CLC [203]									
	160	02.09-10.10	95				0 986 486 064	19,05	
	180 KOMPRESSOR	03.08-05.10	105				0 986 486 064	19,05	
	200 CDI, KOMPRESSOR	03.08-05.10	90/135				0 986 486 064	19,05	
	220 CDI	03.08-05.10	110				0 986 486 064	19,05	
	230	03.08-05.10	150				0 986 486 064	19,05	
	350	03.08-05.10	200				0 986 486 064	19,05	
Serie CLK (Cabrio) [208]									
	200, KOMPRESSOR	OFD 09.96-06.00	100/142	Fg.-Nr. →F 129678, →T 028295	JBH		0 986 480 937	23,8	
	230 KOMPRESSOR	OFD 06.98-05.00	142	Fg.-Nr. →F 129678, →T 028295	JBH		0 986 480 937	23,8	
	320	OFD 06.98-01.03	160	Fg.-Nr. →F 129678, →T 028295	JBH		0 986 480 937	23,8	
	200, KOMPRESSOR	09.96-01.03	100/120/142				0 986 486 043	19	
	230 KOMPRESSOR	06.98-01.03	142/145				0 986 486 043	19	
	200, KOMPRESSOR	09.96-06.00	100/142				0 986 486 535	23,81	
	230 KOMPRESSOR	06.98-05.00	142				0 986 486 535	23,81	
	55 AMG	09.00-04.02	255	Fg.-Nr. →F 178974, →T 071438 Mod.Jahr 2001→, Fg.-Nr. F 178975→, T 071439→			0 265 202 438 ^M		
	200	MFD 09.96-01.03	100/120/142	Fg.-Nr. F 129679→, T 028296→			0 265 202 451 ^M		
	200 KOMPRESSOR								
	230 KOMPRESSOR	MFD 06.98-01.03	142/145	Fg.-Nr. F 129679→, T 028296→			0 265 202 451 ^M		
	320	06.98-01.03	160				0 265 202 435 ^M		
	430	09.98-01.03	205				0 265 202 435 ^M		
	55 AMG	09.00-04.02	255	Fg.-Nr. F 129679→F 136789, T 028296→T 000730			0 265 109 483 ^M		
	320	06.98-01.03	160	Fg.-Nr. F 129679→F 136789, T 028296→T 000730			0 265 109 483 ^M		
	430	09.98-01.03	205	Fg.-Nr. F 129679→F 136789, T 028296→T 000730			0 265 109 483 ^M		
	55 AMG	09.00-04.02	255				0 265 005 231 ⁵		

		S							
	55 AMG	09.00-04.02	255				0 265 005 201		
	320	06.98-01.03	160				0 265 005 201		
	430	09.98-01.03	205				0 265 005 201		
	200, KOMPRESSOR	09.96-01.03	100/120/142				0 265 005 307		
	230 KOMPRESSOR	06.98-01.03	142/145				0 265 005 307		
	320	06.98-01.03	160			TW	0 265 005 303		
							0 265 005 307		
	430	09.98-01.03	205			TW	0 265 005 303		
							0 265 005 307		
Serie CLK (Cabrio) [209]									
	200 KOMPRESSOR	02.03-12.09	120/135				0 986 486 064	19,05	
	240	02.03-03.05	125				0 986 486 064	19,05	
	280	04.05-12.09	170				0 986 486 064	19,05	
	320 CDI	04.05-12.09	165				0 986 486 064	19,05	
	350	04.05-12.09	200				0 986 486 064	19,05	
Serie CLK (Coupé) [208]									
	200, KOMPRESSOR	OFD 06.97-06.00	100/142	Fg.-Nr. →F 129678, →T 028295		JBH	0 986 480 937	23,8	
	230 KOMPRESSOR	OFD 06.97-06.00	142	Fg.-Nr. →F 129678, →T 028295		JBH	0 986 480 937	23,8	
	320	OFD 01.97-09.02	160	Fg.-Nr. →F 129678, →T 028295		JBH	0 986 480 937	23,8	
	200, KOMPRESSOR	06.97-04.02	100/120/142				0 986 486 043	19	
	230 KOMPRESSOR	06.97-04.02	142/145				0 986 486 043	19	
	200, KOMPRESSOR	06.97-06.00	100/142				0 986 486 535	23,81	
	230 KOMPRESSOR	06.97-06.00	142				0 986 486 535	23,81	
	55 AMG	05.99-04.02	255	Fg.-Nr. →F 136789, →T 000730 Fg.-Nr. F 136790 →F 178974, T 000731 →T 071438 Mod.Jahr 2001 →, Fg.-Nr. F 178975 →, T 071439 →			0 265 202 466 ^M 0 265 202 438 ^M 0 265 202 495 ^M		
	200	MFD 06.97-04.02	100/120/ 142	Fg.-Nr. F 129679 →, T 028296 →			0 265 202 451 ^M		
	200 KOMPRESSOR								
	230 KOMPRESSOR	MFD 06.97-04.02	142/145	Fg.-Nr. F 129679 →, T 028296 →			0 265 202 451 ^M		
	320	01.97-09.02	160				0 265 202 435 ^M		
	430	09.98-04.02	205				0 265 202 435 ^M		
	55 AMG	05.99-04.02	255	Fg.-Nr. →F 136789, →T 000730 Fg.-Nr. F 129679 →F 136789, T 028296 →T 000730			0 265 109 499 ^M 0 265 109 483 ^M		
	320	01.97-09.02	160	Fg.-Nr. F 129679 →F 136789, T 028296 →T 000730			0 265 109 483 ^M		
	430	09.98-04.02	205	Fg.-Nr. F 129679 →F 136789, T 028296 →T 000730			0 265 109 483 ^M		
	55 AMG	05.99-04.02	255				0 265 005 201		
	320	01.97-09.02	160				0 265 005 201		
	430	09.98-04.02	205				0 265 005 201		
	55 AMG	05.99-04.02	255			TW	0 265 005 303		
							0 265 005 307		
	200, KOMPRESSOR	06.97-04.02	100/120/142				0 265 005 307		



		S							
	◀ MERCEDES-BENZ Serie CLK (Coupé) [208]								
	230 KOMPRESSOR	06.97-04.02	142/145				0 265 005 307		
	320	01.97-09.02	160		TW		0 265 005 303		
							0 265 005 307		
	430	09.98-04.02	205		TW		0 265 005 303		
							0 265 005 307		
Serie CLK (Coupé) [209]									
	200 CGI KOMPRESSOR, KOMPRESSOR	05.02-04.09	120/125/135				0 986 486 064	19,05	
	220 CDI	04.05-04.09	100-110				0 986 486 064	19,05	
	240	05.02-03.05	125				0 986 486 064	19,05	
	270 CDI	09.02-03.05	125				0 986 486 064	19,05	
	280	04.05-04.09	170				0 986 486 064	19,05	
	320 CDI	04.05-04.09	165				0 986 486 064	19,05	
	350	04.05-04.09	200				0 986 486 064	19,05	
Serie CLS (Coupé) [218]									
	63 AMG, S 4MATIC, 4MATIC	10.10→	386/410/430				0 265 005 749		
	220 BlueTec	05.14→	120-130				0 265 005 749		
	250 BlueTec, BlueTec 4MATIC, CDI	07.10→	150				0 265 005 749		
	350 CDI, CDI 4MATIC, CGI	10.10→	195/225				0 265 005 749		
	400, 4MATIC	05.14→	245				0 265 005 749		
	500, 4MATIC	02.11→	300				0 265 005 749		
Serie CLS (Shooting Brake) [218]									
	63 AMG S	06.13→	430				0 265 005 749		
	63 AMG, S 4MATIC, 4MATIC	06.12→	410/430				0 265 005 749		
	220 BlueTec	05.14→	120-130				0 265 005 749		
	250 BlueTec, BlueTec 4MATIC, CDI	06.12→	150				0 265 005 749		
	350, BlueTec, BlueTec 4MATIC, CDI, CDI 4MATIC	06.12→	185/190/ 195/225				0 265 005 749		
	400, 4MATIC	05.14→	245				0 265 005 749		
	500, 4MATIC	06.12→	300				0 265 005 749		
Serie CLS [219]									
	55 AMG	06.04-08.06	350				0 265 005 753		
	63 AMG	04.06-03.08	378	Fg.-Nr. →A 140341, Komp.Nr. not for MY2008			0 265 005 753		
		10.07-02.11	378	Fg.-Nr. F 126889→, Komp.Nr. 808			0 265 005 753		
	280	01.08-04.09	170				0 265 005 753		
	300	05.09-09.09	170				0 265 005 753		
	320 CDI	05.05-03.08	155-165	Fg.-Nr. →A 140341, Komp.Nr. 809			0 265 005 753		
		10.07-04.09	155-165	Fg.-Nr. F 127287→, Komp.Nr. 808			0 265 005 753		
	350, CDI	06.04-12.10	165/200				0 265 005 753		
	350 CGI	04.06-03.08	215	Fg.-Nr. →A 140341, Komp.Nr. 809			0 265 005 753		
		10.07-09.10	215	Fg.-Nr. F 126889→, Komp.Nr. 808			0 265 005 753		
	500	06.04-04.06	225				0 265 005 753		
		04.06-03.08	285	Fg.-Nr. →A 140341, Komp.Nr. 809			0 265 005 753		
		10.07-09.10	285	Fg.-Nr. F 126889→, Komp.Nr. 808			0 265 005 753		
Serie E (Cabrio) [124]									
	36 AMG	07.93-06.98	195/200	Fg.-Nr. →C 164263	JBH		0 986 480 020	19,05	
				Fg.-Nr. C 164264→	JBH		0 986 480 721	23,81	
	200	07.93-06.98	100	Fg.-Nr. →C 164263	JBH		0 986 480 020	19,05	
				Fg.-Nr. C 164264→	JBH		0 986 480 721	23,81	

		S							
220		07.93-06.98	110	Fg.-Nr. →C 164263	JBH		0 986 480 020	19,05	
				Fg.-Nr. C 164264→	JBH		0 986 480 721	23,81	
320		05.93-06.98	162-170	Fg.-Nr. →C 164263	JBH		0 986 480 020	19,05	
				Fg.-Nr. C 164264→	JBH		0 986 480 721	23,81	
	36 AMG	07.93-06.98	195/200				0 986 486 043	19	
	200	07.93-06.98	100				0 986 486 043	19	
	220	07.93-06.98	110				0 986 486 043	19	
	320	05.93-06.98	162-170				0 986 486 043	19	
	36 AMG	07.93-06.98	195/200		KL		0 986 486 535	23,81	
					KL		0 986 486 503	23,81	
	200	07.93-06.98	100		KL		0 986 486 535	23,81	
					KL		0 986 486 503	23,81	
	220	07.93-06.98	110		KL		0 986 486 535	23,81	
					KL		0 986 486 503	23,81	
	320	05.93-06.98	162-170		KL		0 986 486 535	23,81	
					KL		0 986 486 503	23,81	
	36 AMG	07.93-06.98	195/200				0 265 200 027 ^H		
	200	07.93-06.98	100				0 265 200 027 ^H		
	220	07.93-06.98	110				0 265 200 027 ^H		
	320	05.93-06.98	162-170				0 265 200 027 ^H		
	36 AMG	07.93-06.98	195/200				0 265 101 021 ^H		
	200	07.93-06.98	100				0 265 101 021 ^H		
	220	07.93-06.98	110				0 265 101 021 ^H		
	320	05.93-06.98	162-170				0 265 101 021 ^H		
Serie E (Cabrio) [207]									
	200 CGI	01.10-12.13	135	Mod.Jahr 2010→2011	EAL,TW		0 265 239 490 ^T		
	220 CDI	01.10→	125	Mod.Jahr 2010→2011	EAL,TW		0 265 239 490 ^T		
	250 CDI, CGI	01.10→	150	Mod.Jahr 2010→2011	EAL,TW		0 265 239 490 ^T		
	300 CGI	01.11→	185	Mod.Jahr →2011	EAL,TW		0 265 239 490 ^T		
	350	01.10→	200	Mod.Jahr 2010→2011	EAL,TW		0 265 239 490 ^T		
	350 CDI	01.10-01.11	170	Komp.Nr. 801 , Komp.Nr. 051			0 265 239 490 ^T		
		04.11-04.13	195	Mod.Jahr →2011	EAL,TW		0 265 239 490 ^T		
	350 CGI	01.10-01.11	215	Komp.Nr. 801 , Komp.Nr. 051			0 265 239 490 ^T		
		02.11→	225	Mod.Jahr →2011	EAL,TW		0 265 239 490 ^T		
	500	01.10-01.11	285	Komp.Nr. 801 , Komp.Nr. 051			0 265 239 490 ^T		
	500 CGI	02.11→	300	Mod.Jahr →2011	EAL,TW		0 265 239 490 ^T		
	200 CGI	01.10-12.13	135				0 265 005 749		
	220 BlueTec, CDI	01.10→	125-130				0 265 005 749		
	250 BlueTec, CDI, CGI	01.10→	150				0 265 005 749		
	300 CGI	01.11→	185				0 265 005 749		
	320	07.14→	200				0 265 005 749		
	350, CDI, CGI	01.10→	170/195/200/215/225				0 265 005 749		
	400	02.13→	245				0 265 005 749		
	500, CGI	01.10→	285/300				0 265 005 749		
Serie E (Coupé) [124]									
	36 AMG	07.93-06.96	195/200	Fg.-Nr. →C 164263	JBH		0 986 480 020	19,05	
				Fg.-Nr. C 164264→	JBH		0 986 480 721	23,81	
	200	07.93-06.97	100	Fg.-Nr. →C 164263	JBH		0 986 480 020	19,05	
				Fg.-Nr. C 164264→	JBH		0 986 480 721	23,81	
	220	07.93-06.97	110	Fg.-Nr. →C 164263	JBH		0 986 480 020	19,05	
				Fg.-Nr. C 164264→	JBH		0 986 480 721	23,81	



◀ MERCEDES-BENZ Serie E (Coupé) [124]								
320	07.93-06.98	162	Fg.-Nr. →C 164263	JBH	0 986 480 020	19,05		
			Fg.-Nr. C 164264→	JBH	0 986 480 721	23,81		
	36 AMG	07.93-06.96	195/200		0 986 486 043	19		
	200	07.93-06.97	100		0 986 486 043	19		
	220	07.93-06.97	110		0 986 486 043	19		
	320	07.93-06.98	162		0 986 486 043	19		
	36 AMG	07.93-06.96	195/200	KL	0 986 486 535	23,81		
				KL	0 986 486 503	23,81		
	200	07.93-06.97	100	KL	0 986 486 535	23,81		
				KL	0 986 486 503	23,81		
	220	07.93-06.97	110	KL	0 986 486 535	23,81		
				KL	0 986 486 503	23,81		
	320	07.93-06.98	162	KL	0 986 486 535	23,81		
				KL	0 986 486 503	23,81		
	36 AMG	07.93-06.96	195/200		0 265 200 027 ^H			
	200	07.93-06.97	100		0 265 200 027 ^H			
	220	07.93-06.97	110		0 265 200 027 ^H			
	320	07.93-06.98	162		0 265 200 027 ^H			
	36 AMG	07.93-06.96	195/200		0 265 101 021 ^H			
	200	07.93-06.97	100		0 265 101 021 ^H			
	220	07.93-06.97	110		0 265 101 021 ^H			
	320	07.93-06.98	162		0 265 101 021 ^H			
Serie E (Coupe) [207]								
	320	07.14→	200		0 265 005 749			
	400	07.14→	245		0 265 005 749			
Serie E (Coupé) [207]								
	200 CGI	07.09-04.13	135	Mod.Jahr 2010→2011	EAL ,TW	0 265 239 490 ^T		
	220 CDI	07.09→	120-125	Mod.Jahr 2010→2011	EAL ,TW	0 265 239 490 ^T		
	250 CDI	02.09→	150	Komp.Nr. 800/801		0 265 239 490 ^T		
	250 CGI	02.09-04.13	150	Mod.Jahr 2010→2011	EAL ,TW	0 265 239 490 ^T		
	300 CGI	01.11→	185	Mod.Jahr →2011	EAL ,TW	0 265 239 490 ^T		
	350	05.09→	200	Mod.Jahr 2010→2011	EAL ,N53,U18	0 265 239 490 ^T		
	350 CDI	02.09-03.11	170	Komp.Nr. 801 , Komp.Nr. 051		0 265 239 490 ^T		
		04.11-04.13	195	Mod.Jahr →2011	EAL ,TW	0 265 239 490 ^T		
	350 CGI	02.09-01.11	215	Komp.Nr. 801 , Komp.Nr. 051		0 265 239 490 ^T		
		02.11→	225	Mod.Jahr →2011	EAL ,TW	0 265 239 490 ^T		
	500	02.09-01.11	285	Komp.Nr. 801 , Komp.Nr. 051		0 265 239 490 ^T		
	500 CGI	02.11→	300	Mod.Jahr 2010→2011	EAL ,TW	0 265 239 490 ^T		
	200, CGI	07.09→	135			0 265 005 749		
	220 BlueTec, CDI	07.09→	120-130			0 265 005 749		
	250 BlueTec, CDI, CGI	02.09→	150			0 265 005 749		
	300 CGI	01.11→	185			0 265 005 749		
	350, CDI, CGI, 4MATIC	02.09→	170/195/200/215/225			0 265 005 749		
	500, CGI	02.09→	285/300			0 265 005 749		
Serie E (T-Model) [212]								
	350 BlueTec 4MATIC	08.12→	185-190			0 265 005 749		





Serie E (T-Modell) [124]

	36 AMG	03.94-05.96	195-200	Fg.-Nr. →F 298225	JBH	0 986 480 020	19,05
				Fg.-Nr. F 298226→	JBH	0 986 480 721	23,81
	200	07.93-05.96	100	Fg.-Nr. →F 298225	JBH	0 986 480 020	19,05
				Fg.-Nr. F 298226→	JBH	0 986 480 721	23,81
	220	07.93-05.96	110	Fg.-Nr. →F 298225	JBH	0 986 480 020	19,05
				Fg.-Nr. F 298226→	JBH	0 986 480 721	23,81
	250 D	07.93-05.96	83/93	Fg.-Nr. →F 298225	JBH	0 986 480 020	19,05
	250 D Turbo			Fg.-Nr. F 298226→	JBH	0 986 480 721	23,81
	280	07.93-05.96	142-145	Fg.-Nr. →F 298225	JBH	0 986 480 020	19,05
				Fg.-Nr. F 298226→	JBH	0 986 480 721	23,81
	300 D, D Turbo, D Turbo 4MATIC, 4MATIC	07.93-05.96	100/ 105-108/ 132	Fg.-Nr. →F 298225	JBH	0 986 480 020	19,05
				Fg.-Nr. F 298226→	JBH	0 986 480 721	23,81
	320	07.93-05.96	162	Fg.-Nr. →F 298225	JBH	0 986 480 020	19,05
				Fg.-Nr. F 298226→	JBH	0 986 480 721	23,81
	36 AMG	03.94-05.96	195-200			0 986 486 043	19
	200	07.93-05.96	100			0 986 486 043	19
	220	07.93-05.96	110			0 986 486 043	19
	250 D, D Turbo	07.93-05.96	83/93			0 986 486 043	19
	280	07.93-05.96	142-145			0 986 486 043	19
	300 D, 4MATIC	07.93-05.96	100/132			0 986 486 043	19
	320	07.93-05.96	162			0 986 486 043	19
	36 AMG	03.94-05.96	195-200		KL	0 986 486 535	23,81
					KL	0 986 486 503	23,81
	200	07.93-05.96	100		KL	0 986 486 535	23,81
					KL	0 986 486 503	23,81
	220	07.93-05.96	110		KL	0 986 486 535	23,81
					KL	0 986 486 503	23,81
	250 D	07.93-05.96	83/93		KL	0 986 486 535	23,81
	250 D Turbo				KL	0 986 486 503	23,81
	280	07.93-05.96	142-145		KL	0 986 486 535	23,81
					KL	0 986 486 503	23,81
	300 D	07.93-05.96	100/132		KL	0 986 486 535	23,81
	300 4MATIC				KL	0 986 486 503	23,81
	320	07.93-05.96	162		KL	0 986 486 535	23,81
					KL	0 986 486 503	23,81
	36 AMG	03.94-05.96	195-200			0 265 200 027 ^H	
	200	07.93-05.96	100			0 265 200 027 ^H	
	220	07.93-05.96	110			0 265 200 027 ^H	
	250 D, D Turbo	07.93-05.96	83/93			0 265 200 027 ^H	
	280	07.93-05.96	142-145			0 265 200 027 ^H	
	300 D, D Turbo, D Turbo 4MATIC, 4MATIC	07.93-05.96	100/105-108/132			0 265 200 027 ^H	
	320	07.93-05.96	162			0 265 200 027 ^H	
	36 AMG	03.94-05.96	195-200			0 265 101 021 ^H	
	200	07.93-05.96	100			0 265 101 021 ^H	
	220	07.93-05.96	110			0 265 101 021 ^H	
	250 D, D Turbo	07.93-05.96	83/93			0 265 101 021 ^H	
	280	07.93-05.96	142-145			0 265 101 021 ^H	
	300 D	07.93-05.96	100			0 265 101 021 ^H	
	300 D Turbo	07.93-05.96	105-108			0 265 101 021 ^H	
	300 D Turbo 4MATIC	07.93-05.96	105-108			0 265 101 023 ^H	
	300 4MATIC	07.93-06.95	132			0 265 101 023 ^H	
	320	07.93-05.96	162			0 265 101 021 ^H	





◀ MERCEDES-BENZ

Serie E (T-Modell) [210]



	200	05.96-05.99	100	Fg.-Nr. →A394035		0986 480 724	19
				Fg.-Nr. A394036→	JBH	0986 481 048	23,81
		07.99-01.03	100	Fg.-Nr. →A394035		0986 480 724	19
				Fg.-Nr. A394036→	JBH	0986 481 048	23,81
	200 KOMPRESSOR	09.97-05.99	137		JBH	0986 480 934	
		07.99-01.03	137		JBH	0986 480 934	
		09.00-01.03	120		JBH	0986 480 934	
	220 CDI	07.98-05.99	92	Fg.-Nr. →A394035	JBH	0986 481 048	23,81
				Fg.-Nr. A 394036→	JBH	0986 480 934	
		07.99-01.03	100-105	Fg.-Nr. →A394035	JBH	0986 481 048	23,81
				Fg.-Nr. A 394036→	JBH	0986 480 934	
	230	05.96-08.97	110	Fg.-Nr. →A394035		0986 480 724	19
				Fg.-Nr. A394036→	JBH	0986 481 048	23,81
	240	09.97-01.03	125	Fg.-Nr. →A394035	JBH	0986 481 048	23,81
				Fg.-Nr. A 394036→	JBH	0986 480 934	
		06.99-01.03	125		JBH	0986 480 934	
	250 D	05.96-06.98	83	Fg.-Nr. →A394035, 210.610	JBH	0986 481 048	23,81
				Fg.-Nr. A 394036→, 210.610	JBH	0986 480 934	
				Fg.-Nr. 210.210		0986 480 724	19
	250 D Turbo	09.97-08.99	110		JBH	0986 480 934	
	270 CDI	07.99-01.03	125		JBH	0986 480 934	
	280	07.99-01.03	150		JBH	0986 480 934	
	280 4MATIC	03.97-05.99	150		JBH	0986 480 934	
		07.99-01.03	150		JBH	0986 480 934	
	290 D Turbo	05.96-05.99	95	Fg.-Nr. →A394035, 210.617	JBH	0986 481 048	23,81
				Fg.-Nr. A 394036→, 210.617	JBH	0986 480 934	
				Fg.-Nr. 210.217		0986 480 724	19
	300 D Turbo	03.97-05.99	130		JBH	0986 480 934	
	320	03.97-05.99	165		JBH	0986 480 934	
		07.99-01.03	165		JBH	0986 480 934	
	320 CDI	07.99-01.03	145		JBH	0986 480 934	
	320 4MATIC	06.97-05.99	165		JBH	0986 480 934	
		07.99-02.03	165		JBH	0986 480 934	
	420	05.96-08.97	205		JBH	0986 480 723	15,4
	200	05.96-05.99	100			0986 486 043	19
						0986 486 043	19
	200 KOMPRESSOR	09.97-05.99	137			0986 486 043	19
		07.99-01.03	137			0986 486 043	19
		09.00-01.03	120			0986 486 043	19
	220 CDI	07.98-05.99	92			0986 486 043	19
		07.99-01.03	100-105			0986 486 043	19
	230	05.96-08.97	110			0986 486 043	19
	240	09.97-01.03	125			0986 486 043	19
	250 D, D Turbo	05.96-08.99	83/110			0986 486 043	19
	270 CDI	06.99-01.03	125			0986 486 043	19
	280	07.96-01.03	150			0986 486 043	19
	290 D Turbo	05.96-05.99	95			0986 486 043	19
	200	05.96-05.99	100			0986 486 535	23,81
						0986 486 535	23,81
	200 KOMPRESSOR	09.97-05.99	137			0986 486 535	23,81
		07.99-01.03	137			0986 486 535	23,81
	220 CDI	07.98-05.99	92			0986 486 535	23,81
		07.99-01.03	100-105			0986 486 535	23,81
	230	05.96-08.97	110			0986 486 535	23,81
	240	09.97-06.99	125			0986 486 535	23,81
	250 D, D Turbo	05.96-08.99	83/110			0986 486 535	23,81
	290 D Turbo	05.96-05.99	95			0986 486 535	23,81



	55 AMG	03.98-05.99	260		0 265 202 435 ^M
		07.99-05.00	260		0 265 202 466 ^M
		06.00-01.03	260		0 265 202 438 ^M
200		05.96-08.97	100		0 265 217 008 ^J
		09.97-05.99	100		0 265 217 403 ^J
		07.99-01.03	100	Fg.-Nr. →B173367 Fg.-Nr. B173368→	0 265 202 466 ^M 0 265 202 438 ^M
	200 KOMPRESSOR	09.97-05.99	137		0 265 217 403 ^J
		07.99-01.03	137		0 265 217 403 ^J
		09.00-01.03	120	Fg.-Nr. →A294393, →B298127, →X053662 Fg.-Nr. →B173367	0 265 202 495 ^M 0 265 202 438 ^M 0 265 202 466 ^M
220 CDI		07.98-05.99	92		0 265 217 403 ^J
		07.99-01.03	100-105		0 265 202 438 ^M 0 265 217 403 ^J
230		05.96-08.97	110		0 265 217 008 ^J
240		09.97-06.99	125		0 265 217 403 ^J
		07.99-01.03	125	Fg.-Nr. →B173367 Fg.-Nr. B173368→	0 265 202 466 ^M 0 265 202 438 ^M
250 D		05.96-08.97	83		0 265 217 008 ^J
		09.97-06.98	83		0 265 217 403 ^J
250 D Turbo		09.97-08.99	110		0 265 217 403 ^J
270 CDI		06.99-01.03	125		0 265 202 438 ^M
280		07.96-01.03	150		0 265 202 466 ^M
290 D Turbo		05.96-08.97	95		0 265 217 008 ^J
		09.97-05.99	95		0 265 217 403 ^J
300 D Turbo		03.97-05.99	130		0 265 217 403 ^J
320		03.97-05.99	165		0 265 217 403 ^J
		07.99-01.03	165		0 265 217 403 ^J
320 CDI		07.99-01.03	145		0 265 202 438 ^M
420		05.96-08.97	205		0 265 202 022 ^M 0 265 202 023 ^M 0 265 202 110 ^Q 0 265 217 008 ^J
	430	09.97-05.99	205		0 265 217 403 ^J
	430 4MATIC	06.97-01.03	205	Fg.-Nr. →A294393, →B298127, →X053662 Fg.-Nr. →B173367 Fg.-Nr. A294394→, B298128→, X053663→	0 265 202 438 ^M 0 265 202 466 ^M 0 265 202 495 ^M

	55 AMG	03.98-05.99	260		FMS	0 265 109 487 ^M				
					GRA,PML	0 265 109 052 ^J				
					GRA,PML	0 265 109 056 ^J				
					FMS	0 265 109 489 ^M				
					Fg.-Nr. B174000→, Komp.Nr. Code 800	FMS,PML	0 265 109 499 ^M			
					07.99-01.03	260		FMS	0 265 109 487 ^M	
								GRA,PML	0 265 109 052 ^J	
								GRA,PML	0 265 109 056 ^J	
								FMS	0 265 109 489 ^M	
								Fg.-Nr. B174000→, Komp.Nr. Code 800	FMS,PML	0 265 109 499 ^M
				200		05.96-03.97	100		PML	0 265 109 053 ^K
						05.96-05.99	100		GRA,PML	0 265 109 052 ^J
					GRA,PML	0 265 109 056 ^J				
	07.99-01.03	100			GRA,PML	0 265 109 052 ^J				
					GRA,PML	0 265 109 056 ^J				
200 KOMPRESSOR	09.97-05.99	137		AG,PML	0 265 109 486 ^M					
				AG,PML	0 265 109 489 ^M					
				GRA	0 265 109 052 ^J					
				GRA,PML	0 265 109 056 ^J					
				GS,PML	0 265 109 436 ^M					
				GS,PML	0 265 109 488 ^M					



◀ MERCEDES-BENZ Serie E (T-Modell) [210]												
200	KOMPRESSOR	07.99-01.03	137		AG,PML			0 265 109 486 ^M				
					AG,PML		0 265 109 489 ^M					
					GRA		0 265 109 052 ^J					
					GRA,PML		0 265 109 056 ^J					
					GS,PML		0 265 109 436 ^M					
			09.00-01.03	120		PML		0 265 109 499 ^M				
		220	CDI	07.98-05.99	92		GRA,PML		0 265 109 052 ^J			
							GRA,PML		0 265 109 056 ^J			
							Fg.-Nr. →B173999, Komp.Nr. Code 801	PML	0 265 109 499 ^M			
							Fg.-Nr. →B173999, 210.206;606, Komp.Nr. Code 801	PML	0 265 109 470 ^M			
	Fg.-Nr. B174000→, Komp.Nr. Code 800					PML	0 265 109 471 ^M					
	07.99-01.03			100-105		Fg.-Nr. B174000→, 210.606, Komp.Nr. Code 800	PML	0 265 109 483 ^M				
						GRA,PML		0 265 109 052 ^J				
						GRA,PML		0 265 109 056 ^J				
						Fg.-Nr. →B173999, Komp.Nr. Code 801	PML	0 265 109 499 ^M				
						Fg.-Nr. →B173999, 210.206;606, Komp.Nr. Code 801	PML	0 265 109 470 ^M				
				Fg.-Nr. B174000→, Komp.Nr. Code 800	PML	0 265 109 471 ^M						
				Fg.-Nr. B174000→, 210.606, Komp.Nr. Code 800	PML	0 265 109 483 ^M						
230		05.96-03.97	110		PML		0 265 109 053 ^K					
		05.96-08.97	110		GRA,PML		0 265 109 052 ^J					
240		09.97-01.03	125		GRA,PML		0 265 109 056 ^J					
					GRA,PML		0 265 109 052 ^J					
	PML				0 265 109 487 ^M							
	Fg.-Nr. →A829877			PML	0 265 109 451 ^M							
	Fg.-Nr. A829878→			PML	0 265 109 484 ^M							
	06.99-01.03	125		PML		0 265 109 499 ^M						
250 D		05.96-03.97	83		PML		0 265 109 053 ^K					
		05.96-06.98	83		GRA,PML		0 265 109 052 ^J					
250 D Turbo		09.97-08.99	110		GRA,PML		0 265 109 056 ^J					
						0 265 109 487 ^M						
	GRA,PML				0 265 109 052 ^J							
270 CDI		06.99-01.03	125		GRA,PML		0 265 109 056 ^J					
					Fg.-Nr. →B173999, Komp.Nr. Code 801	PML	0 265 109 499 ^M					
					Fg.-Nr. →B173999, 210.216;616, Komp.Nr. Code 801	PML	0 265 109 470 ^M					
					Fg.-Nr. B174000→, Komp.Nr. Code 800	PML	0 265 109 471 ^M					
				Fg.-Nr. B174000→, 210.616, Komp.Nr. Code 800	PML	0 265 109 483 ^M						
280		07.96-01.03	150		GRA,PML		0 265 109 052 ^J					
					GRA,PML		0 265 109 056 ^J					
			Fg.-Nr. →B173999, 210.263, Komp.Nr. Code 801	GS,PML	0 265 109 436 ^M							
			Fg.-Nr. →B173999, 210.263, Komp.Nr. Code 801	AG,PML	0 265 109 484 ^M							
				AG,PML	0 265 109 487 ^M							
				GS,PML	0 265 109 488 ^M							
			Fg.-Nr. B174000→, 210.263, Komp.Nr. Code 800	PML	0 265 109 499 ^M							



		S							
280		07.96-01.03	150	Fg.-Nr. B174000→, 210.663, Komp.Nr. Code 800	PML	0 265 109 483 ^M			
					PML	0 265 109 471 ^M			
280 4MATIC		03.97-05.99	150		GRA	0 265 109 054 ^K			
		07.99-01.03	150		GRA	0 265 109 054 ^K			
290 D Turbo		05.96-05.99	95		PML	0 265 109 053 ^K			
				Fg.-Nr. →A177063, →J024801, Komp.Nr. Code 807, Komp.Nr. Code 806	GRA,PML	0 265 106 114 ^J			
				Fg.-Nr. A177064→A394035, J024802→, Komp.Nr. Code 806;808, Komp.Nr. Code 807;809	GRA,PML	0 265 109 057 ^J			
				Fg.-Nr. A394036→, Komp.Nr. Code 807, Komp.Nr. Code 808	GRA,PML	0 265 109 052 ^J			
300 D Turbo		03.97-05.99	130		GRA,PML	0 265 109 056 ^J			
					GRA	0 265 109 056 ^J			
320		03.97-05.99	165		GRA,PML	0 265 109 052 ^J			
					GRA,PML	0 265 109 056 ^J			
				Fg.-Nr. →B173999, Komp.Nr. Code 801	AG,PML	0 265 109 484 ^M			
					AG,PML	0 265 109 487 ^M			
					GS,PML	0 265 109 436 ^M			
					GS,PML	0 265 109 488 ^M			
				Fg.-Nr. B174000→, Komp.Nr. Code 800	PML	0 265 109 499 ^M			
		07.99-01.03	165		GRA,PML	0 265 109 052 ^J			
					GRA,PML	0 265 109 056 ^J			
				Fg.-Nr. →B173999, Komp.Nr. Code 801	AG,PML	0 265 109 484 ^M			
					AG,PML	0 265 109 487 ^M			
					GS,PML	0 265 109 436 ^M			
					GS,PML	0 265 109 488 ^M			
				Fg.-Nr. B174000→, Komp.Nr. Code 800	PML	0 265 109 499 ^M			
320 CDI		07.99-01.03	145		PML	0 265 109 499 ^M			
320 4MATIC		06.97-05.99	165		GRA	0 265 109 054 ^K			
		07.99-02.03	165		GRA	0 265 109 054 ^K			
420		05.96-08.97	205		ATP	0 265 109 064 ^M			
					GRA	0 265 109 057 ^J			
430		09.97-05.99	205		FMS	0 265 109 487 ^M			
					GRA	0 265 109 056 ^J			
				Fg.-Nr. →B173999, Komp.Nr. Code 801	FMS,PML	0 265 109 489 ^M			
					FMS,PML	0 265 109 471 ^M			
				Fg.-Nr. B174000→, Komp.Nr. Code 800	FMS,PML	0 265 109 499 ^M			
		07.99-01.03	205		FMS	0 265 109 487 ^M			
					GRA	0 265 109 056 ^J			
				Fg.-Nr. →B173999, Komp.Nr. Code 801	FMS,PML	0 265 109 489 ^M			
					FMS,PML	0 265 109 471 ^M			
				Fg.-Nr. B174000→, Komp.Nr. Code 800	FMS,PML	0 265 109 499 ^M			
430 4MATIC		06.97-01.03	205		PML	0 265 109 440 ^M			
				Fg.-Nr. →B110357, →X037893	PML	0 265 109 471 ^M			
55 AMG		03.98-05.99	260			0 265 005 201			
		07.99-01.03	260			0 265 005 201			
200		05.96-05.99	100			0 265 005 201			
		07.99-01.03	100			0 265 005 201			
200 KOMPRESSOR		09.97-05.99	137			0 265 005 201			
		07.99-01.03	137			0 265 005 201			
		09.00-01.03	120			0 265 005 258			





	◀ MERCEDES-BENZ Serie E (T-Modell) [210]				
	220 CDI	07.98-05.99	92		0 265 005 258
		07.99-01.03	100-105		0 265 005 258
	230	05.96-08.97	110		0 265 005 258
	240	09.97-01.03	125		0 265 005 201
		06.99-01.03	125		0 265 005 258
	270 CDI	06.99-01.03	125		0 265 005 258
	280, 4MATIC	07.96-01.03	150		0 265 005 201
	300 D Turbo	03.97-05.99	130		0 265 005 201
	320	03.97-05.99	165		0 265 005 201
		07.99-01.03	165		0 265 005 201
	320 CDI	07.99-01.03	145		0 265 005 258
	320 4MATIC	06.97-05.99	165		0 265 005 201
		07.99-02.03	165		0 265 005 201
	420	05.96-08.97	205		0 265 005 201
	430, 4MATIC	06.97-01.03	205		0 265 005 201

	55 AMG	03.98-05.99	260	TW	0 265 005 303
		07.99-01.03	260	TW	0 265 005 307
					0 265 005 303
					0 265 005 307
	200	05.96-05.99	100	TW	0 265 005 303
		07.99-01.03	100	TW	0 265 005 307
					0 265 005 303
					0 265 005 307
	200 KOMPRESSOR	09.97-05.99	137	TW	0 265 005 303
		07.99-01.03	137	TW	0 265 005 303
					0 265 005 307
		09.00-01.03	120	TW	0 265 005 303
					0 265 005 307
	220 CDI	07.98-05.99	92	TW	0 265 005 303
		07.99-01.03	100-105	TW	0 265 005 307
					0 265 005 303
					0 265 005 307
	240	09.97-01.03	125	TW	0 265 005 303
					0 265 005 307
	270 CDI	06.99-01.03	125	TW	0 265 005 303
					0 265 005 307
	280	07.96-01.03	150	TW	0 265 005 303
	280 4MATIC				0 265 005 307
	320	03.97-05.99	165	TW	0 265 005 303
		07.99-01.03	165	TW	0 265 005 307
					0 265 005 303
					0 265 005 307
	320 CDI	07.99-01.03	145	TW	0 265 005 303
					0 265 005 307
	320 4MATIC	06.97-05.99	165	TW	0 265 005 303
		07.99-02.03	165	TW	0 265 005 307
					0 265 005 303
					0 265 005 307
	430	06.97-01.03	205	TW	0 265 005 303
	430 4MATIC				0 265 005 307

Serie E (T-Modell) [211]

	55 AMG KOMPRESSOR	07.04-05.06	350		0 265 109 538 ^M
	280, CDI, CDI 4MATIC, 4MATIC	04.04-08.09	130/140/170	ATP,VSP	0 265 109 538 ^M
	320 CDI, CDI 4MATIC	04.05-08.09	165	ATP,VSP	0 265 109 538 ^M
	350, 4MATIC	02.05-08.09	200	ATP,VSP	0 265 109 538 ^M

	55 AMG KOMPRESSOR	09.03-05.06	350		0 265 005 258
				Komp.Nr. 048	0 265 005 753

		S							
63 AMG		06.06-08.09	378						0 265 005 753
200 CDI		04.07-08.09	100		Komp.Nr. 048				0 265 005 753
200 KOMPRESSOR		02.03-03.06	120						0 265 005 258
					Komp.Nr. 048				0 265 005 753
		04.06-08.09	135						0 265 005 753
220 CDI		02.03-08.09	100/110						0 265 005 258
					Komp.Nr. 048				0 265 005 753
		04.06-08.09	125						0 265 005 753
230		09.07-08.09	150						0 265 005 753
240		02.03-08.09	130						0 265 005 258
240 4MATIC					Komp.Nr. 048				0 265 005 753
270 CDI		02.03-03.05	120-130						0 265 005 258
					Komp.Nr. 048				0 265 005 753
280, CDI, CDI 4MATIC, 4MATIC		04.05-08.09	140/170						0 265 005 753
280 CDI		04.04-03.05	130						0 265 005 258
					Komp.Nr. 048				0 265 005 753
320		02.03-03.05	165		Komp.Nr. 048				0 265 005 753
320, 4MATIC		02.03-03.05	165						0 265 005 258
320 CDI		02.03-03.05	150						0 265 005 258
					Komp.Nr. 048				0 265 005 753
320 CDI, CDI 4MATIC		04.05-08.09	165						0 265 005 753
320 4MATIC		09.03-03.05	165		Komp.Nr. 048				0 265 005 753
350, CGI, 4MATIC		02.05-08.09	200/215						0 265 005 753
500		09.03-08.06	225						0 265 005 258
500 4MATIC					Komp.Nr. 048				0 265 005 753
		04.06-08.09	285						0 265 005 753
Serie E (T-Modell) [212]									
	200 CDI	08.09→	100		Komp.Nr. +051+801, Komp.Nr. -052+802	EAL			0 265 239 490 ^T
	200 CGI	08.09-12.13	135		Mod.Jahr 2010→2011	EAL,TW			0 265 239 490 ^T
	220 CDI	08.09→	125		Mod.Jahr 2010→2011	EAL,TW			0 265 239 490 ^T
	250 CDI	08.09→	150		Mod.Jahr 2010→2011	EAL,TW			0 265 239 490 ^T
	250 CDI 4MATIC	01.11→	150		Mod.Jahr →2011	EAL,TW			0 265 239 490 ^T
	250 CGI	08.09-12.13	150		Mod.Jahr 2010→2011	EAL,TW			0 265 239 490 ^T
	300 CDI	12.09-12.10	150		Komp.Nr. +051+801, Komp.Nr. 802	EAL			0 265 239 490 ^T
		07.10-12.13	170		Mod.Jahr 2010→2011	EAL,TW			0 265 239 490 ^T
		08.11-12.13	170		Mod.Jahr →2011	EAL,TW			0 265 239 490 ^T
	350, 4MATIC	08.09-07.11	200		Komp.Nr. +051+801, Komp.Nr. 802	EAL			0 265 239 490 ^T
	350 BlueTec	08.09-12.13	155		Mod.Jahr 2010→2011	EAL,TW			0 265 239 490 ^T
	350 CDI, CDI 4MATIC	12.10→	195		Mod.Jahr →2011	EAL,TW			0 265 239 490 ^T
	350 CGI	08.09-07.11	215		Komp.Nr. +051+801, Komp.Nr. -052+802	EAL			0 265 239 490 ^T
	500	08.09-07.11	285		Komp.Nr. 801, Komp.Nr. -052+802	EAL			0 265 239 490 ^T
	63 AMG, S, S 4MATIC, 4MATIC	08.09→	386/410/430						0 265 005 749
	200, BlueTec, CDI, CGI	08.09→	100/135						0 265 005 749
	220 BlueTec, BlueTec 4MATIC, CDI	08.09→	125						0 265 005 749
	250, BlueTec, BlueTec 4MATIC, CDI, CDI 4MATIC, CGI	08.09→	150/155						0 265 005 749
	300, BlueTec, CDI, 4MATIC	12.09→	150/170/185						0 265 005 749
	350, BlueTec, CDI, CDI 4MATIC, CGI, 4MATIC	08.09→	155/170/185/195/ 200/215/225						0 265 005 749
	400, 4MATIC	01.13→	245						0 265 005 749
	500, 4MATIC	08.09→	285/300						0 265 005 749



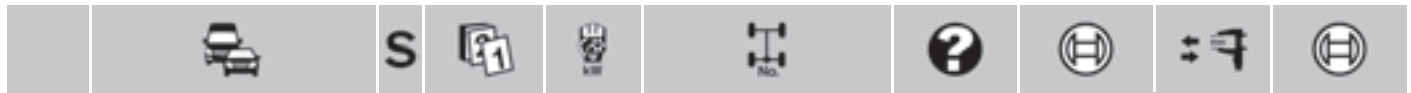

◀ MERCEDES-BENZ

Serie E [124]



	60 AMG	07.93-06.95	280	Fg.-Nr. →B 927760	JBH	0986 480 895	19
				Fg.-Nr. B 927761→		0986 480 896	26
	200	07.93-07.95	100	Fg.-Nr. →F 298225	JBH	0986 480 020	19,05
				Fg.-Nr. F 298226→	JBH	0986 480 721	23,81
	200 D	07.93-06.95	55		JBH	0986 480 020	19,05
	220	07.93-06.95	110	Fg.-Nr. →F 298225	JBH	0986 480 020	19,05
				Fg.-Nr. F 298226→	JBH	0986 480 721	23,81
	250 D	07.93-06.95	83	Fg.-Nr. →C 164263	JBH,LLE	0986 480 020	19,05
				Fg.-Nr. C 164264→	JBH,LLE	0986 480 721	23,81
	250 D Turbo	07.93-06.95	93		JBH	0986 480 020	19,05
	280	07.93-06.95	142	Fg.-Nr. →C 164263	JBH,LLE	0986 480 020	19,05
				Fg.-Nr. C 164264→	JBH,LLE	0986 480 721	23,81
	300 D	07.93-06.95	100	Fg.-Nr. →F 298225	JBH	0986 480 020	19,05
				Fg.-Nr. F 298226→	JBH	0986 480 721	23,81
	300 D Turbo	07.93-06.95	108	Fg.-Nr. →F 298225	JBH	0986 480 020	19,05
				Fg.-Nr. F 298226→	JBH	0986 480 721	23,81
	300 D Turbo 4MATIC	07.93-06.95	108		JBH	0986 480 020	19,05
	300 4MATIC	07.93-06.95	132	Fg.-Nr. →F 298225	JBH	0986 480 020	19,05
				Fg.-Nr. F 298226→	JBH	0986 480 721	23,81
	320	07.93-06.95	162	Fg.-Nr. →F 298225	JBH	0986 480 020	19,05
				Fg.-Nr. F 298226→	JBH	0986 480 721	23,81
	420	07.93-06.95	205/210	Fg.-Nr. →C 164263	JBH	0986 480 895	19
	500	07.93-06.95	235-240	Fg.-Nr. →B 927760	JBH	0986 480 895	19
				Fg.-Nr. B 927761→		0986 480 896	26
		09.93-08.94	235		JBH	0986 480 895	19















	200, D	07.93-07.95	55/100			0986 486 043	19
	220	07.93-06.95	110			0986 486 043	19
	250 D, D Turbo	07.93-06.95	83/93			0986 486 043	19
	280	07.93-06.95	142			0986 486 043	19
	300 D, 4MATIC	07.93-06.95	100/132			0986 486 043	19
	320	07.93-06.95	162			0986 486 043	19

	200	07.93-07.95	100		KL	0986 486 535	23,81
					KL	0986 486 503	23,81
	200 D	07.93-06.95	55			0986 486 503	23,81
	220	07.93-06.95	110		KL	0986 486 535	23,81
					KL	0986 486 503	23,81
	250 D	07.93-06.95	83/93		KL	0986 486 535	23,81
	250 D Turbo				KL	0986 486 503	23,81
	280	07.93-06.95	142			0986 486 535	23,81
	300 D	07.93-06.95	100/132		KL	0986 486 535	23,81
	300 4MATIC				KL	0986 486 503	23,81
	320	07.93-06.95	162		KL	0986 486 535	23,81
					KL	0986 486 503	23,81

	200, D	07.93-07.95	55/100			0 265 200 027^H	
	220	07.93-06.95	110			0 265 200 027^H	
	250 D, D Turbo	07.93-06.95	83/93			0 265 200 027^H	
	280	07.93-06.95	142			0 265 200 027^H	
	300 D, D Turbo, D Turbo 4MATIC, 4MATIC	07.93-06.95	100/108/132			0 265 200 027^H	
	320	07.93-06.95	162			0 265 200 027^H	
	420	07.93-06.95	205/210			0 265 200 027^H	

	200, D	07.93-07.95	55/100			0 265 101 021^H	
	220	07.93-06.95	110			0 265 101 021^H	
	250 D, D Turbo	07.93-06.95	83/93			0 265 101 021^H	
	280	07.93-06.95	142			0 265 101 021^H	
	300 D	07.93-06.95	100			0 265 101 021^H	

		S							
	300 D Turbo	07.93-06.95	108				0 265 101 021^H		
	300 D Turbo 4MATIC	07.93-06.95	108				0 265 101 023^H		
	300 4MATIC	07.93-06.95	132				0 265 101 023^H		
	320	07.93-06.95	162				0 265 101 021^H		
	500	07.93-06.95	235-240				0 265 005 107		
Serie E [210]									
									
	50 AMG	01.96-08.97	205-235			JBH	0 986 480 723	15,4	
	55 AMG	09.97-03.03	260	Fg.-Nr. →A 962231, Komp.Nr. Code 809		JBH	0 986 480 934		
	200	06.95-02.01	100	Fg.-Nr. →A394035			0 986 480 724	19	
				Fg.-Nr. A 962232→	JBH		0 986 480 934		
				Fg.-Nr. A394036→A962231	JBH		0 986 481 048	23,81	
	200 CDI	07.98-03.02	75/85	Fg.-Nr. →A962231	JBH		0 986 481 048	23,81	
				Fg.-Nr. A 962232→	JBH		0 986 480 934		
	200 D	03.97-05.99	65	Fg.-Nr. →A394035			0 986 480 724	19	
				Fg.-Nr. A394036→	JBH		0 986 481 048	23,81	
	200 KOMPRESSOR	09.97-08.00	137			JBH	0 986 480 934		
		09.00-03.02	120			FMS,JBH	0 986 480 934		
	220 CDI	07.98-05.99	92	Fg.-Nr. →A962231	JBH		0 986 481 048	23,81	
				Fg.-Nr. A 962232→	JBH		0 986 480 934		
		07.99-03.02	100-105	Fg.-Nr. →A962231	JBH		0 986 481 048	23,81	
				Fg.-Nr. A 962232→	JBH		0 986 480 934		
	220 D	06.95-05.99	55-70	Fg.-Nr. →A394035			0 986 480 724	19	
				Fg.-Nr. A394036→	JBH		0 986 481 048	23,81	
	230	06.95-08.97	110	Fg.-Nr. →A394035			0 986 480 724	19	
				Fg.-Nr. A394036→	JBH		0 986 481 048	23,81	
	240	04.00-03.02	125			JBH	0 986 480 934		
		MFD 09.97-04.00	125			JBH	0 986 480 934		
		OFD 09.97-04.00	125			JBH	0 986 481 048	23,81	
	250 D	06.95-05.99	83	Fg.-Nr. →A394035			0 986 480 724	19	
				Fg.-Nr. A394036→	JBH		0 986 481 048	23,81	
	250 D Turbo	09.97-05.99	110			JBH	0 986 481 048	23,81	
	270 CDI	07.99-03.02	125			JBH	0 986 480 934		
	280	06.95-01.03	150			FMS,JBH	0 986 480 934		
		01.96-02.97	142			JBH	0 986 480 723	15,4	
	280 4MATIC	03.97-05.99	150			JBH	0 986 480 934		
		07.99-01.03	150			JBH	0 986 480 934		
	290 D Turbo	01.96-05.99	95	Fg.-Nr. →A394035			0 986 480 724	19	
				Fg.-Nr. A394036→	JBH		0 986 481 048	23,81	
	300 D	06.95-02.97	100				0 986 480 724	19	
	300 D Turbo	03.97-05.99	130			JBH	0 986 480 934		
	320	06.95-02.97	162			JBH	0 986 480 723	15,4	
		03.97-05.99	165			JBH	0 986 480 934		
		07.99-08.03	165			JBH	0 986 480 934		
	320 CDI	07.99-03.02	145			JBH	0 986 480 934		
	320 4MATIC	09.97-05.99	165			JBH	0 986 480 934		
		07.99-03.02	165			JBH	0 986 480 934		
	420	01.96-08.97	205			JBH	0 986 480 723	15,4	
	430, 4MATIC	09.97-03.02	205			FMS,JBH	0 986 480 934		
	200, CDI, D	06.95-03.02	65/75/100				0 986 486 043	19	
	220 CDI, D	06.95-05.99	55-70/92				0 986 486 043	19	
	230	06.95-08.97	110				0 986 486 043	19	
	240	09.97-03.02	125				0 986 486 043	19	
	250 D	06.95-05.99	83				0 986 486 043	19	
	280	06.95-01.03	142/150				0 986 486 043	19	
	290 D Turbo	01.96-05.99	95				0 986 486 043	19	
	300 D	06.95-02.97	100				0 986 486 043	19	



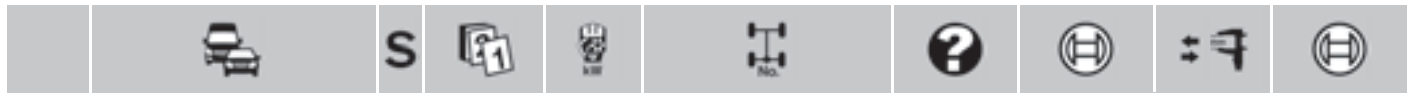

◀ MERCEDES-BENZ Serie E [210]

	200	06.95-02.01	100	Get.-Nr. →717.418 6 411804	0 986 486 503	23,81
				Get.-Nr. 717.417. ...	0 986 486 535	23,81
				Get.-Nr. 717.418 6 411805→	0 986 486 535	23,81
	200 CDI	07.98-03.02	75		0 986 486 535	23,81
	200 D	03.97-05.99	65	Get.-Nr. →416 6 410204	0 986 486 503	23,81
				Get.-Nr. 416 6 410205→	0 986 486 535	23,81
	220 CDI	07.98-05.99	92		0 986 486 535	23,81
	220 D	06.95-05.99	55-70	Get.-Nr. →416 6 410204	0 986 486 503	23,81
				Get.-Nr. 416 6 410205→	0 986 486 535	23,81
	230	06.95-08.97	110	MZM	0 986 486 535	23,81
	240	09.97-04.00	125		0 986 486 535	23,81
	250 D	06.95-05.99	83	MZM	0 986 486 535	23,81
	280	06.95-01.03	142/150		0 986 486 535	23,81
	300 D	06.95-02.97	100		0 986 486 535	23,81
	50 AMG	01.96-08.97	205-235		0 265 202 022^M	
					0 265 202 110^Q	
					0 265 217 008^J	
	55 AMG	09.97-03.03	260	TW	0 265 202 435^M	
					0 265 202 438^M	
					0 265 202 466^M	
					0 265 202 495^T	
	200	06.95-02.01	100		0 265 202 435^M	
				Mot.-Nr. →A394035, Komp.Nr. Code 808,	0 265 217 008^J	
				Komp.Nr. Code 807		
				Mot.-Nr. A394036→, Komp.Nr. Code 807,	0 265 217 403^J	
				Komp.Nr. Code 808		
	200 CDI	07.98-03.02	75/85		0 265 202 435^M	
					0 265 217 403^J	
	200 D	03.97-05.99	65	Mot.-Nr. →A394035, Komp.Nr. Code 808,	0 265 217 008^J	
				Komp.Nr. Code 807		
				Mot.-Nr. A394036→, Komp.Nr. Code 807,	0 265 217 403^J	
				Komp.Nr. Code 808		
	200 KOMPRESSOR	09.97-08.00	137		0 265 202 435^M	
					0 265 217 403^J	
		09.00-03.02	120		0 265 202 435^M	
	220 CDI	07.98-05.99	92		0 265 202 435^M	
					0 265 217 403^J	
		07.99-03.02	100-105		0 265 202 435^M	
					0 265 217 403^J	
	220 D	06.95-05.99	55-70	Mot.-Nr. →A394035, Komp.Nr. Code 808,	0 265 217 008^J	
				Komp.Nr. Code 807		
				Mot.-Nr. A394036→, Komp.Nr. Code 807,	0 265 217 403^J	
				Komp.Nr. Code 808		
	230	06.95-08.97	110	Mot.-Nr. →A394035, Komp.Nr. Code 808,	0 265 217 008^J	
				Komp.Nr. Code 807		
				Mot.-Nr. A394036→, Komp.Nr. Code 807,	0 265 217 403^J	
				Komp.Nr. Code 808		
	240	09.97-04.00	125		0 265 217 403^J	
		09.97-03.02	125		0 265 202 435^M	
	250 D	06.95-05.99	83	Mot.-Nr. →A394035, Komp.Nr. Code 808,	0 265 217 008^J	
				Komp.Nr. Code 807		
				Mot.-Nr. A394036→, Komp.Nr. Code 807,	0 265 217 403^J	
				Komp.Nr. Code 808		
	250 D Turbo	09.97-05.99	110		0 265 217 403^J	
	270 CDI	06.99-03.02	125		0 265 202 435^M	
	280	06.95-01.03	150		0 265 202 435^M	
					0 265 217 403^J	
		01.96-02.97	142		0 265 217 008^J	
	280 4MATIC	03.97-05.99	150		0 265 202 435^M	
		07.99-05.00	150	Fg.-Nr. →B173367	0 265 202 466^M	
		06.00-01.03	150	Fg.-Nr. B173368→	0 265 202 438^M	



		S							
290 D Turbo	01.96-05.99	95		Mot.-Nr. →A394035, Komp.Nr. Code 808, Komp.Nr. Code 807				0 265 217 008 ^J	
				Mot.-Nr. A394036→, Komp.Nr. Code 807, Komp.Nr. Code 808				0 265 217 403 ^J	
300 D	06.95-02.97	100						0 265 217 008 ^J	
300 D Turbo	03.97-05.99	130						0 265 202 435 ^M	
								0 265 217 403 ^J	
320	06.95-02.97	162						0 265 217 008 ^J	
	03.97-05.99	165						0 265 202 435 ^M	
								0 265 217 403 ^J	
	07.99-08.03	165						0 265 202 435 ^M	
								0 265 217 403 ^J	
320 CDI	06.99-03.02	145						0 265 202 435 ^M	
320 4MATIC	09.97-05.99	165						0 265 202 435 ^M	
	07.99-03.02	165						0 265 202 435 ^M	
420	01.96-08.97	205						0 265 202 022 ^M	
								0 265 202 110 ^Q	
								0 265 217 008 ^J	
430	09.97-05.99	205						0 265 202 435 ^M	
	07.99-03.02	205			TW			0 265 202 435 ^M	
								0 265 202 438 ^M	
								0 265 202 466 ^M	
								0 265 202 495 ^T	
430 4MATIC	06.99-03.02	205						0 265 202 435 ^M	
50 AMG	01.96-08.97	205-235				ATP		0 265 109 064 ^M	
55 AMG	09.97-03.03	260				FMS		0 265 109 487 ^M	
						GRA		0 265 109 056 ^J	
						FMS,PML		0 265 109 499 ^M	
				Fg.-Nr. →B173999, Komp.Nr. Code 801		FMS,PML		0 265 109 489 ^M	
200	06.95-03.97	100		Fg.-Nr. A177064→, J024802→		PML		0 265 109 053 ^K	
	06.95-02.01	100				GRA,PML		0 265 109 052 ^J	
						GRA,PML		0 265 109 056 ^J	
				Fg.-Nr. →A177063, →J024801		KTS,PML		0 265 106 113 ^K	
						KTS,PML		0 265 106 112 ^K	
				Fg.-Nr. →B173999, Komp.Nr. Code 801		AG,PML		0 265 109 486 ^M	
						AG,PML		0 265 109 489 ^M	
						GS,PML		0 265 109 436 ^M	
						GS,PML		0 265 109 488 ^M	
				Fg.-Nr. B174000→, Komp.Nr. Code 800		PML		0 265 109 499 ^M	
200 CDI	07.98-03.02	75/85				GRA,PML		0 265 109 052 ^J	
						GRA,PML		0 265 109 056 ^J	
						PML		0 265 109 499 ^M	
				Fg.-Nr. →B173999, Komp.Nr. Code 801		PML		0 265 109 470 ^M	
200 D	03.97-05.99	65				GRA,PML		0 265 109 052 ^J	
						GRA,PML		0 265 109 056 ^J	
						PML		0 265 109 053 ^K	
200 KOMPRESSOR	09.97-08.00	137				AG,PML		0 265 109 486 ^M	
						AG,PML		0 265 109 489 ^M	
						GRA,PML		0 265 109 056 ^J	
						GRA,PML		0 265 109 052 ^J	
						GS,PML		0 265 109 436 ^M	
						GS,PML		0 265 109 488 ^M	
	09.00-03.02	120				PML		0 265 109 499 ^M	
220 CDI	07.98-05.99	92				GRA,PML		0 265 109 056 ^J	
						GRA,PML		0 265 109 052 ^J	
						PML		0 265 109 499 ^M	
				Fg.-Nr. →B173999, Komp.Nr. Code 801		PML		0 265 109 470 ^M	



		S											
◀ MERCEDES-BENZ Serie E [210]													
220 CDI	07.99-03.02	100-105				GRA,PML	0 265 109 056 ^J						
						GRA,PML	0 265 109 052 ^J						
						PML	0 265 109 499 ^M						
			Fg.-Nr. →B173999, Komp.Nr. Code 801			PML	0 265 109 470 ^M						
220 D	06.95-03.97	55-70	Fg.-Nr. A177064→, J024802→			PML	0 265 109 053 ^K						
						06.95-05.99	55-70			GRA,PML	0 265 109 052 ^J		
								Fg.-Nr. →A177063, →J024801		KTS,PML	0 265 106 113 ^K		
	03.97-05.99	55-70				GRA,PML	0 265 109 056 ^J						
230	06.95-03.97	110	Fg.-Nr. A177064→, J024802→			PML	0 265 109 053 ^K						
						06.95-08.97	110			GRA,PML	0 265 109 052 ^J		
								Fg.-Nr. →A177063, →J024801		KTS,PML	0 265 106 113 ^K		
						KTS,PML	0 265 106 112 ^K						
240	09.97-04.00	125				AG,PML	0 265 109 484 ^M						
						AG,PML	0 265 109 487 ^M						
						GRA,PML	0 265 109 052 ^J						
						GRA,PML	0 265 109 056 ^J						
						GS,PML	0 265 109 436 ^M						
						GS,PML	0 265 109 488 ^M						
	04.00-03.02	125				PML	0 265 109 499 ^M						
250 D	06.95-03.97	83	Fg.-Nr. A177064→, J024802→			PML	0 265 109 053 ^K						
						06.95-05.99	83			GRA,PML	0 265 109 052 ^J		
								Fg.-Nr. →A177063, →J024801		KTS,PML	0 265 106 113 ^K		
						KTS,PML	0 265 106 112 ^K						
	03.97-05.99	83				GRA,PML	0 265 109 056 ^J						
250 D Turbo	09.97-05.99	110				GRA,PML	0 265 109 052 ^J						
						GRA,PML	0 265 109 056 ^J						
270 CDI	06.99-03.02	125				PML	0 265 109 499 ^M						
						Fg.-Nr. →B173999, Komp.Nr. Code 801		PML	0 265 109 470 ^M				
280	06.95-01.03	150				GRA,PML	0 265 109 052 ^J						
						GRA,PML	0 265 109 056 ^J						
						PML	0 265 109 487 ^M						
						Fg.-Nr. →A829877		PML	0 265 109 451 ^M				
						Fg.-Nr. A829878→		PML	0 265 109 484 ^M				
						01.96-02.97	142			KTS,PML	0 265 106 113 ^K		
					KTS,PML	0 265 106 112 ^K							
						PML	0 265 106 097 ^J						
280 4MATIC	03.97-05.99	150				GRA	0 265 109 054 ^K						
						07.99-01.03	150			GRA	0 265 109 054 ^K		
290 D Turbo	01.96-05.99	95	Fg.-Nr. →A177063, →J024801, Komp.Nr. Code 807, Komp.Nr. Code 806			GRA,PML	0 265 106 114 ^J						
						Fg.-Nr. A177064→A394035, J024802→, Komp.Nr. Code 806,808, Komp.Nr. Code 807;809		GRA,PML	0 265 109 057 ^J				
						Fg.-Nr. A394036→, Komp.Nr. Code 807, Komp.Nr. Code 808		GRA,PML	0 265 109 052 ^J				
								GRA,PML	0 265 109 056 ^J				
										KTS,PML	0 265 106 113 ^K		
300 D	06.95-02.97	100				KTS,PML	0 265 106 113 ^K						
						KTS,PML	0 265 106 112 ^K						
300 D Turbo	03.97-05.99	130					0 265 109 487 ^M						
						GRA	0 265 109 056 ^J						



		S									
320	06.95-02.97	162			KTS,PML	0 265 106 113 ^K					
					KTS,PML	0 265 106 112 ^K					
					PML	0 265 106 097 ^J					
	03.97-05.99	165				GRA,PML	0 265 109 052 ^J				
						GRA,PML	0 265 109 056 ^J				
						Fg.-Nr. →B173999, Komp.Nr. Code 801	AG,PML	0 265 109 484 ^M			
						AG,PML	0 265 109 487 ^M				
						GS,PML	0 265 109 436 ^M				
						GS,PML	0 265 109 488 ^M				
	07.99-08.03	165				Fg.-Nr. B174000→, Komp.Nr. Code 800	PML	0 265 109 499 ^M			
						GRA,PML	0 265 109 052 ^J				
						GRA,PML	0 265 109 056 ^J				
Fg.-Nr. →B173999, Komp.Nr. Code 801					AG,PML	0 265 109 484 ^M					
					AG,PML	0 265 109 487 ^M					
					GS,PML	0 265 109 436 ^M					
					GS,PML	0 265 109 488 ^M					
					PML	0 265 109 499 ^M					
320 CDI	06.99-03.02	145			PML	0 265 109 499 ^M					
420	01.96-08.97	205			Fg.-Nr. →A177063, →J024801	GRA	0 265 106 114 ^J				
					Fg.-Nr. A177064→, J024802→	GRA	0 265 109 057 ^J				
430	09.97-05.99	205			GRA	0 265 109 056 ^J					
					PML	0 265 109 499 ^M					
	07.99-03.02	205				Fg.-Nr. →B173999	PML	0 265 109 489 ^M			
						GRA	0 265 109 056 ^J				
Fg.-Nr. →B173999					PML	0 265 109 499 ^M					
					PML	0 265 109 489 ^M					
	50 AMG	01.96-08.97	205-235			0 265 005 201					
	55 AMG	09.97-03.03	260	Fg.-Nr. →B173999, Komp.Nr. Code 801, Fg.-Nr. →X044900		0 265 005 201					
200	06.95-02.01	100			Fg.-Nr. B174000→, Komp.Nr. Code 800, Fg.-Nr. X037894→	0 265 005 258					
					Fg.-Nr. →B173999, Komp.Nr. Code 801, Fg.-Nr. →X044900	0 265 005 201					
					Fg.-Nr. B174000→, Komp.Nr. Code 800, Fg.-Nr. X037894→	0 265 005 258					
200 CDI	07.98-03.02	75/85				0 265 005 258					
200 KOMPRESSOR	09.97-08.00	137			Fg.-Nr. →B173999, Komp.Nr. Code 801, Fg.-Nr. →X044900	0 265 005 201					
					Fg.-Nr. B174000→, Komp.Nr. Code 800, Fg.-Nr. X037894→	0 265 005 258					
						0 265 005 258					
220 CDI	09.00-03.02	120				0 265 005 258					
	07.98-05.99	92				0 265 005 258					
	07.99-03.02	100-105				0 265 005 258					
230	06.95-08.97	110				0 265 005 258					
240	09.97-04.00	125			Fg.-Nr. →B173999, Komp.Nr. Code 801, Fg.-Nr. →X044900	0 265 005 201					
					Fg.-Nr. B174000→, Komp.Nr. Code 800, Fg.-Nr. X037894→	0 265 005 258					
						0 265 005 258					
270 CDI	04.00-03.02	125				0 265 005 258					
	06.99-03.02	125				0 265 005 258					
	06.95-01.03	150	Fg.-Nr. →B173999, Komp.Nr. Code 801, Fg.-Nr. →X044900			0 265 005 201					
280 4MATIC					Fg.-Nr. B174000→, Komp.Nr. Code 800, Fg.-Nr. X037894→	0 265 005 258					
						0 265 005 258					
300 D Turbo	03.97-05.99	130				0 265 005 201					
320	03.97-05.99	165			Fg.-Nr. →B173999, Komp.Nr. Code 801, Fg.-Nr. →X044900	0 265 005 201					



◀ MERCEDES-BENZ Serie E [210]								
320	03.97-05.99	165	Fg.-Nr. B174000→, Komp.Nr. Code 800, Fg.-Nr. X037894→			0 265 005 258		
	07.99-08.03	165	Fg.-Nr. →B173999, Komp.Nr. Code 801, Fg.-Nr. →X044900			0 265 005 201		
			Fg.-Nr. B174000→, Komp.Nr. Code 800, Fg.-Nr. X037894→			0 265 005 258		
320 CDI	06.99-03.02	145				0 265 005 258		
320 4MATIC	09.97-05.99	165	Fg.-Nr. →B173999, Komp.Nr. Code 801, Fg.-Nr. →X044900			0 265 005 201		
			Fg.-Nr. B174000→, Komp.Nr. Code 800, Fg.-Nr. X037894→			0 265 005 258		
	07.99-03.02	165	Fg.-Nr. →B173999, Komp.Nr. Code 801, Fg.-Nr. →X044900			0 265 005 201		
			Fg.-Nr. B174000→, Komp.Nr. Code 800, Fg.-Nr. X037894→			0 265 005 258		
420	01.96-08.97	205				0 265 005 201		
430	09.97-03.02	205	Fg.-Nr. →B173999, Komp.Nr. Code 801, Fg.-Nr. →X044900			0 265 005 201		
			Fg.-Nr. B174000→, Komp.Nr. Code 800, Fg.-Nr. X037894→			0 265 005 258		
55 AMG								
	09.97-03.03	260			TW	0 265 005 303		
						0 265 005 307		
200, CDI, KOMPRESSOR	06.95-03.02	75/85/100/120/137			TW	0 265 005 303		
						0 265 005 307		
220 CDI	07.98-05.99	92			TW	0 265 005 303		
						0 265 005 307		
	07.99-03.02	100-105			TW	0 265 005 303		
						0 265 005 307		
240	09.97-03.02	125			TW	0 265 005 303		
						0 265 005 307		
270 CDI	06.99-03.02	125			TW	0 265 005 303		
						0 265 005 307		
280	06.95-01.03	150			TW	0 265 005 303		
						0 265 005 307		
280 4MATIC						0 265 005 307		
320, CDI, 4MATIC	03.97-08.03	145/165			TW	0 265 005 303		
						0 265 005 307		
430	09.97-03.02	205			TW	0 265 005 303		
						0 265 005 307		
Serie E [211]								
	55 AMG KOMPRESSOR	07.04-05.06	350				0 265 109 538 ^M	
	280 CDI, CDI 4MATIC, 4MATIC	04.04-03.09	130/140/170	ATP,VSP			0 265 109 538 ^M	
	320 CDI, CDI 4MATIC	04.05-03.09	165	ATP,VSP			0 265 109 538 ^M	
	350, 4MATIC	02.05-03.09	200	ATP,VSP			0 265 109 538 ^M	
	420 CDI	09.05-01.09	231	ATP,VSP			0 265 109 538 ^M	
	55 AMG KOMPRESSOR	10.02-05.06	350				0 265 005 258	
				Komp.Nr. 048			0 265 005 753	
	63 AMG	06.06-01.09	378				0 265 005 753	
	200 CDI	07.02-12.06	75/90				0 265 005 258	
				Komp.Nr. 048			0 265 005 753	
		04.06-03.09	100				0 265 005 753	
	200 KOMPRESSOR	04.06-01.09	135				0 265 005 753	
	200 KOMPRESSOR	03.02-09.08	120				0 265 005 258	
	200 KOMPRESSOR NGT			Komp.Nr. 048			0 265 005 753	
	220 CDI	03.02-01.09	100/110				0 265 005 258	
				Komp.Nr. 048			0 265 005 753	
		04.06-03.09	120-125				0 265 005 753	
	230	09.07-03.09	150				0 265 005 753	

		S							
240		03.02-03.05	130	Komp.Nr. 048			0 265 005 753		
				Mod.Jahr →2003			0 265 005 258		
				Mod.Jahr 2004→			0 265 005 753		
240 4MATIC		09.03-03.09	130				0 265 005 258		
				Komp.Nr. 048			0 265 005 753		
270 CDI		03.02-03.05	120-130				0 265 005 258		
				Komp.Nr. 048			0 265 005 753		
280		04.05-03.09	140/170				0 265 005 753		
280 CDI		04.04-03.05	130				0 265 005 258		
				Komp.Nr. 048			0 265 005 753		
280 CDI, CDI 4MATIC, 4MATIC		04.05-03.09	140/170				0 265 005 753		
300 BlueTec		12.07-01.09	155				0 265 005 753		
320		03.02-03.05	165				0 265 005 753		
				Mod.Jahr →2004			0 265 005 258		
320 CDI		11.02-08.06	150				0 265 005 258		
				Komp.Nr. 048			0 265 005 753		
320 CDI, CDI 4MATIC		04.05-03.09	165				0 265 005 753		
320 4MATIC		09.03-03.05	165				0 265 005 258		
				Komp.Nr. 048			0 265 005 753		
350, CGI, 4MATIC		02.05-03.09	200/215				0 265 005 753		
400 CDI		02.03-04.05	191				0 265 005 258		
				Komp.Nr. 048			0 265 005 753		
420 CDI		09.05-01.09	231				0 265 005 753		
500		03.02-03.06	225	Komp.Nr. 048			0 265 005 753		
				Mod.Jahr →2003			0 265 005 258		
				Mod.Jahr 2004→			0 265 005 753		
		04.06-03.09	285				0 265 005 753		
500 4MATIC		09.03-08.06	225				0 265 005 258		
				Komp.Nr. 048			0 265 005 753		
		09.06-01.09	285				0 265 005 753		

Serie E [212]

200 CDI		04.09→	100	Mod.Jahr 2010→2011	EAL,TW		0 265 239 490 ^T		
200 CGI		04.09-12.13	135	Fg.-Nr. 2010→Mod.Jahr 2011	EAL,FKR,TW		0 265 239 490 ^T		
200 NGT		01.11-04.13	120	Mod.Jahr →2011	EAL,TW		0 265 239 490 ^T		
220 CDI		12.08→	120-125	Mod.Jahr 2010→2011	EAL,TW		0 265 239 490 ^T		
250 CDI		12.08→	150	Mod.Jahr 2010→2011	EAL,TW		0 265 239 490 ^T		
250 CDI 4MATIC		01.11→	150	Mod.Jahr →2011	EAL,TW		0 265 239 490 ^T		
250 CGI		04.09-12.13	150	Fg.-Nr. 2010→Mod.Jahr 2011	EAL,FKR,TW		0 265 239 490 ^T		
300 CDI		12.09-12.10	150	Komp.Nr. +051+801, Komp.Nr. 802	EAL		0 265 239 490 ^T		
		07.10-12.13	170	Mod.Jahr →2011	EAL,TW		0 265 239 490 ^T		
300 L		04.09→	170		TW		0 265 239 490 ^T		
300 4MATIC		07.11-12.13	185	Mod.Jahr →2011	EAL,TW		0 265 239 490 ^T		
350		04.09-07.11	200	Komp.Nr. +051+801, Komp.Nr. -052+802	EAL		0 265 239 490 ^T		
350 BlueTec		04.09-12.13	155	Mod.Jahr 2010→2011	EAL,TW		0 265 239 490 ^T		
350 CDI, CDI 4MATIC		12.10→	195	Mod.Jahr →2011	EAL,TW		0 265 239 490 ^T		
350 CGI		04.09-12.11	215	Mod.Jahr 2010→2011	EAL,TW		0 265 239 490 ^T		
500		04.09-08.11	285	Komp.Nr. +051+801, Komp.Nr. -052+802	EAL		0 265 239 490 ^T		
63 AMG, S 4MATIC, 4MATIC		04.09→	386/410/430				0 265 005 749		
180		12.12→	115				0 265 005 749		
200, BlueTec, CDI, CGI, NGT		04.09→	100/115/120/135				0 265 005 749		
220 BlueTec, BlueTec 4MATIC, CDI		12.08→	120-130				0 265 005 749		
250, BlueTec, BlueTec 4MATIC, CDI, CDI 4MATIC, CGI		12.08→	150/155				0 265 005 749		
300, BlueTec, CDI, L, 4MATIC		04.09→	150/170/185				0 265 005 749		
350, BlueTec, BlueTec 4MATIC, CDI, CDI 4MATIC, CGI, 4MATIC		08.08→	155/170/185-190/ 195/200/215/225				0 265 005 749		



		S							
	◀ MERCEDES-BENZ Serie E [212]								
	400, 4MATIC	01.13→	245					0 265 005 749	
	500, 4MATIC	01.09→	285/300					0 265 005 749	
Serie G [461]									
	230 E	04.92-09.95	92			JBH		0 986 480 954	25,4
	280 CDI	ABS 04.09→	135			JBH		0 986 480 997	25,4
	300 CDI	ABO 09.09→	135			JBH,NOR		0 986 480 997	25,4
		ABS 09.09→	135			JBH		0 986 480 997	25,4
	230 E	10.89-09.95	92					0 986 486 547	23,81
	280 CDI	04.09→	135	Mod.Jahr →2010				0 265 230 258 ^T	
	290 DT	04.97-09.01	90					0 265 213 009 ^H	
	300 CDI	09.09→	135			TW		0 265 230 258 ^T	
Serie G [463]									
	230	06.90-06.95	93			JBH,LLE		0 986 480 954	25,4
	300, D	09.89-07.97	83/125/126			JBH,LLE		0 986 480 954	25,4
	350 D Turbo	09.93-06.96	100			JBH,LLE		0 986 480 954	25,4
	500 AMG E	03.93-09.01	195			JBH,LLE		0 986 480 954	25,4
	230	06.90-06.95	93					0 986 486 535	23,81
	300, D	09.89-07.97	83/126					0 986 486 535	23,81
	55 AMG	04.99-03.04	260					0 265 202 495 ^T	
	55 AMG KOMPRESSOR	04.04-08.11	350-373			TW		0 265 202 495 ^T	
	230	06.90-06.95	93			3-K		0 265 200 027 ^H	
						4-K		0 265 201 031 ^H	
	270 CDI	10.01-08.06	115					0 265 202 495 ^M	
	300	09.89-07.97	83/125/			3-K		0 265 200 027 ^H	
	300 D		126			4-K		0 265 201 031 ^H	
	300 D Turbo	09.96-11.00	130					0 265 213 009 ^H	
	320	08.93-11.97	155					0 265 200 027 ^H	
		06.97-11.97	154					0 265 202 495 ^M	
		12.97-08.06	158					0 265 213 009 ^H	
	320 CDI	09.06-05.08	165	Fg.-Nr. →X 177215				0 265 235 285 ^T	
	350 D Turbo	09.93-06.96	100			3-K		0 265 200 027 ^H	
						4-K		0 265 201 031 ^H	
	400 CDI	12.00-08.06	184					0 265 202 495 ^M	
	500	04.98-09.05	218					0 265 213 009 ^H	
		06.98-09.05	218	Fg.-Nr. →127356				0 265 213 403 ^H	
				Fg.-Nr. 127357→				0 265 202 495 ^M	
		09.01-08.08	218			TW		0 265 202 495 ^T	
	500 AMG E	03.93-09.01	195			3-K		0 265 200 027 ^H	
						4-K		0 265 201 031 ^H	
	55 AMG	04.99-03.04	260	Fg.-Nr. →134620				0 265 109 495 ^M	
				Fg.-Nr. 134621→				0 265 109 625 ^M	
	230	06.90-06.95	93			4-K		0 265 105 015 ^H	
	270 CDI	10.01-08.06	115	Fg.-Nr. →145325				0 265 109 625 ^M	
				Fg.-Nr. 145326→				0 265 109 765 ^M	
	300, D	09.89-07.97	83/125/126			4-K		0 265 105 015 ^H	
	320	06.97-11.97	154	Fg.-Nr. →145325				0 265 109 625 ^M	
				Fg.-Nr. 145326→				0 265 109 765 ^M	
	400 CDI	12.00-08.06	184	Fg.-Nr. →145325				0 265 109 625 ^M	
				Fg.-Nr. 145326→				0 265 109 765 ^M	
	500	06.98-09.05	218	Fg.-Nr. →145325				0 265 109 625 ^M	
				Fg.-Nr. 145326→				0 265 109 765 ^M	



		S							
	500 AMG E	03.93-09.01	195			4-K	0 265 105 015 ^H		
	230	06.90-06.95	93			4-K	0 265 002 230		
		11.93-06.95	93			4-K	0 265 005 040		
	300	04.90-10.94	83/125/126			4-K	0 265 002 230		
	300 D	11.93-10.94	83/125/126			4-K	0 265 005 040		
	55 AMG	04.99-03.04	260				0 265 005 258		
	55 AMG KOMPRESSOR	04.04-05.08	350-373	Fg.-Nr. →X 177217			0 265 005 258		
		06.08-08.11	350-373	Fg.-Nr. X 177218 →			0 265 005 774		
	63 AMG	04.12 →	400	Komp.Nr. XZ2			0 265 005 774		
	65 AMG	04.12 →	450				0 265 005 774		
	270 CDI	10.01-08.06	115				0 265 005 258		
	320	06.97-11.97	154				0 265 005 258		
	320 CDI	09.06-05.08	165	Fg.-Nr. →X 177217			0 265 005 628		
		06.08-12.09	165	Fg.-Nr. X 177218 →			0 265 005 774		
	350 BlueTec	07.10 →	155-165	Komp.Nr. XZ2			0 265 005 774		
	400 CDI	12.00-08.06	184				0 265 005 258		
	500	06.98-09.05	218				0 265 005 258		
		09.01-05.08	218	Fg.-Nr. →X 177217			0 265 005 258		
		06.08-08.08	218	Fg.-Nr. X 177218 →			0 265 005 774		
		06.08-09.13	285	Fg.-Nr. →X 215936			0 265 005 774		
Serie ML [163]									
	230	03.98-06.00	110				0 986 486 043	19	
	270 CDI	11.99-06.05	120				0 986 486 043	19	
	230	03.98-06.00	110				0 986 486 535	23,81	
	270 CDI	11.99-06.05	120				0 986 486 535	23,81	
Serie S (Coupé) [140]									
	500	09.93-09.97	235-240	Fg.-Nr. →A 110606	LLE		0 986 480 896	26	
	600	06.93-05.96	290-300	Fg.-Nr. →A 110606	LLE		0 986 480 896	26	
	420	03.94-05.96	205-210				0 265 202 022 ^M		
							0 265 202 110 ^Q		
							0 265 217 008 ^J		
				Fg.-Nr. →A212244			0 265 217 004 ^J		
				Fg.-Nr. A212245 →			0 265 217 004 ^J		
							0 265 202 023 ^M		
	500	08.95-05.96	205-210				0 265 200 027 ^H		
							0 265 202 022 ^M		
							0 265 202 110 ^Q		
							0 265 217 008 ^J		
				Fg.-Nr. →A212244			0 265 217 004 ^J		
				Fg.-Nr. A212245 →			0 265 217 004 ^J		
600	08.95-09.97	235-240				0 265 202 023 ^M			
						0 265 200 027 ^H			
						0 265 202 022 ^M			
						0 265 202 110 ^Q			
						0 265 217 004 ^J			
			Fg.-Nr. →A212244			0 265 217 008 ^J			
			Fg.-Nr. A212245 →			0 265 217 004 ^J			
CPU	420	03.94-05.96	205-210				0 265 109 071 ^M		
							0 265 101 047 ^H		
							0 265 109 071 ^M		
500	09.93-09.97	235-240				0 265 101 047 ^H			
						0 265 109 071 ^M			
						0 265 109 071 ^M			
						0 265 106 071 ^J			
						0 265 106 071 ^J			
600	06.93-05.96	290-300				0 265 106 071 ^J			
						0 265 109 071 ^M			
						0 265 106 071 ^J			
						0 265 106 071 ^J			
						0 265 106 071 ^J			



















		S								
◀ MERCEDES-BENZ Serie S (Coupé) [140]										
	600	OFD	06.93-05.96	290-300	Fg.-Nr. →A 290166			0 265 005 107		
	420		05.95-05.96	205-210				0 265 005 201		
	500		05.95-09.97	235-240				0 265 005 201		
	600		05.95-05.96	290-300				0 265 005 201		
	420		05.95-05.96	205-210				0 265 005 300		
	500		05.95-09.97	235-240				0 265 005 300		
	600		05.95-05.96	290-300				0 265 005 300		
Serie S (Coupé) [217]										
	63 AMG 4MATIC		04.14 →	430				0 265 005 749		
	65 AMG		06.14 →	463				0 265 005 749		
	500, 4MATIC		02.14 →	335/430				0 265 005 749		
Serie S [140]										
	280		06.93-09.98	142-145	Fg.-Nr. →A 212244	JBH		0 986 480 895	19	
	320		03.93-02.99	170	Fg.-Nr. →A 212244	JBH		0 986 480 895	19	
	350 D Turbo		09.93-06.96	100-110	Fg.-Nr. →A 212244	JBH		0 986 480 895	19	
	420		06.93-09.98	205-210	Fg.-Nr. →A 110606	LLE		0 986 480 896	26	
	500		06.93-09.98	235-240	Fg.-Nr. →A 110606	LLE		0 986 480 896	26	
	600		06.93-09.98	290-300	Fg.-Nr. →A 110606	LLE		0 986 480 896	26	
	280		06.93-09.98	142-145				0 986 486 043	19	
	320		03.93-02.99	170				0 986 486 043	19	
	280		06.93-09.98	142-145				0 986 486 535	23,81	
	320		03.93-02.99	170				0 986 486 535	23,81	
	280		06.93-09.98	142-145				0 265 200 027 ^H		
								0 265 202 022 ^M		
								0 265 202 110 ^Q		
	300 D Turbo		06.96-09.98	130				0 265 202 022 ^M		
								0 265 202 110 ^Q		
					Fg.-Nr. →A212244			0 265 217 008 ^T		
					Fg.-Nr. A212245 →			0 265 217 004 ^T		
	320		03.93-02.99	170				0 265 200 027 ^H		
								0 265 202 022 ^M		
								0 265 202 110 ^Q		
			05.93-02.99	170	Fg.-Nr. →A290166			0 265 217 004 ^J		
					Fg.-Nr. A290167 →			0 265 217 008 ^J		
	350 D Turbo		09.93-06.96	100-110				0 265 200 027 ^H		
								0 265 202 022 ^M		
					Fg.-Nr. →A212244			0 265 217 008 ^T		
					Fg.-Nr. A212245 →			0 265 217 004 ^T		
	420		06.93-09.98	205-210				0 265 200 027 ^H		
								0 265 202 022 ^M		
								0 265 202 110 ^Q		
	500		06.93-09.98	235-240				0 265 200 027 ^H		
								0 265 202 022 ^M		
								0 265 202 110 ^Q		
	600		06.93-09.98	290-300				0 265 202 022 ^M		
								0 265 202 110 ^Q		
	280		06.93-09.98	142-145	Fg.-Nr. →A 212244			0 265 101 045 ^H		
								0 265 106 064 ^J		



		S							
300 D Turbo		06.96-09.98	130						0 265 109 070 ^M
				Fg.-Nr. A 328811→	GRA				0 265 109 054 ^K
320		03.93-02.99	170	Fg.-Nr. →A 212244					0 265 101 045 ^H
				Fg.-Nr. A151633→A212244,					0 265 106 064 ^J
				Komp.Nr. Code 803, Komp.Nr. Code 867					
350 D Turbo		09.93-06.96	100-110	Fg.-Nr. →A 212244					0 265 101 045 ^H
420		06.93-09.98	205-210						0 265 101 047 ^H
									0 265 106 071 ^J
									0 265 109 071 ^M
			210						0 265 101 047 ^H
									0 265 109 071 ^M
				Fg.-Nr. →A212244, Komp.Nr. Code 867					0 265 106 071 ^J
500		06.93-09.98	235-240						0 265 101 047 ^H
									0 265 109 071 ^M
				Fg.-Nr. →A212244, Komp.Nr. Code 867					0 265 106 071 ^J
600		06.93-09.98	290-300						0 265 109 071 ^M
				Fg.-Nr. →A212244, Komp.Nr. Code 867					0 265 106 071 ^J
	420	06.93-09.98	205-210						0 265 005 107
	500	06.94-09.98	235-240						0 265 005 107
	600	06.93-09.98	290-300						0 265 005 107
	420	09.95-09.98	210						0 265 005 201
Serie S [220]									
	55 AMG	09.00-09.02	265	Fg.-Nr. →A 138350					0 265 202 441 ^M
				Fg.-Nr. A 138351→					0 265 202 446 ^M
	55 AMG KOMPRESSOR	09.02-08.06	368						0 265 202 446 ^M
	65 AMG	02.04-08.06	450						0 265 202 446 ^M
	280	01.99-08.05	150	Fg.-Nr. →A 138350					0 265 202 441 ^M
				Fg.-Nr. A 138351→					0 265 202 446 ^M
	320	10.98-08.02	165	Fg.-Nr. →A 138350					0 265 202 441 ^M
				Fg.-Nr. A 138351→					0 265 202 446 ^M
	320 CDI	06.99-08.05	145/150						0 265 202 446 ^M
	350, 4MATIC	09.02-08.06	180						0 265 202 446 ^M
	400 CDI	06.99-08.05	184/191						0 265 202 446 ^M
	430	10.98-01.06	205	Fg.-Nr. →A 138350					0 265 202 441 ^M
				Fg.-Nr. A 138351→					0 265 202 446 ^M
	430 4MATIC	09.02-09.05	205						0 265 202 446 ^M
	500	10.98-09.05	225		FMS				0 265 202 438 ^M
				Fg.-Nr. →A 138350	FMS				0 265 202 441 ^M
				Fg.-Nr. A 138351→	FMS				0 265 202 446 ^M
			10.98-08.06	225	Fg.-Nr. →A 138350				0 265 202 441 ^M
					Fg.-Nr. A 138351→				0 265 202 446 ^M
	500 4MATIC	09.02-09.05	225						0 265 202 446 ^M
	600	08.99-08.02	270		FMS				0 265 202 438 ^M
					FMS				0 265 202 446 ^M
		08.99-08.05	270						0 265 202 446 ^M
		09.02-01.06	368						0 265 202 446 ^M
	55 AMG	09.00-08.02	265	Fg.-Nr. →A 322443					0 265 109 497 ^M
				Fg.-Nr. A 322444→					0 265 109 745 ^M
		09.00-09.02	265	Fg.-Nr. →A 322443	FMS				0 265 109 447 ^M
					FMS				0 265 109 497 ^M
				Fg.-Nr. A 322444→	FMS				0 265 109 609 ^M
					FMS				0 265 109 745 ^M
	55 AMG KOMPRESSOR	09.02-08.06	368						0 265 109 745 ^M
	65 AMG	02.04-08.06	450						0 265 109 745 ^M



		S							
◀ MERCEDES-BENZ Serie S [220]									
280	01.99-08.02	150	Fg.-Nr. →A 138350				0 265 109 492 ^M		
			Fg.-Nr. A 138351→A 322443				0 265 109 497 ^M		
			Fg.-Nr. A 322444→				0 265 109 745 ^M		
	01.99-08.05	150			FMS		0 265 109 609 ^M		
					FMS		0 265 109 745 ^M		
320	10.98-08.02	165	Fg.-Nr. →A 138350				0 265 109 492 ^M		
						FMS	0 265 109 492 ^M		
			Fg.-Nr. →A 322443			FMS	0 265 109 447 ^M		
			Fg.-Nr. A 138351→A 322443				0 265 109 497 ^M		
						FMS	0 265 109 497 ^M		
			Fg.-Nr. A 322444→				0 265 109 745 ^M		
						FMS	0 265 109 609 ^M		
			FMS	0 265 109 745 ^M					
320 CDI	06.99-08.02	145	Fg.-Nr. →A 322443				0 265 109 497 ^M		
						FMS	0 265 109 447 ^M		
						FMS	0 265 109 497 ^M		
			Fg.-Nr. A 322444→				0 265 109 745 ^M		
						FMS	0 265 109 609 ^M		
			FMS	0 265 109 745 ^M					
	09.02-08.05	150				0 265 109 745 ^M			
350	09.02-08.06	180				0 265 109 745 ^M			
350 4MATIC	06.03-08.05	180				0 265 109 743 ^M			
400 CDI	06.99-08.05	184/191	Fg.-Nr. →A 322443				0 265 109 497 ^M		
						FMS	0 265 109 447 ^M		
						FMS	0 265 109 497 ^M		
			Fg.-Nr. A 322444→				0 265 109 607 ^M		
						FMS	0 265 109 609 ^M		
			FMS	0 265 109 607 ^M					
430	10.98-09.05	205	Fg.-Nr. →A 138350				0 265 109 492 ^M		
			Fg.-Nr. →A 322443			FMS	0 265 109 447 ^M		
			Fg.-Nr. A 138351→A 322443			FMS	0 265 109 497 ^M		
			Fg.-Nr. A 322444→			FMS	0 265 109 609 ^M		
						FMS	0 265 109 607 ^M		
	10.98-01.06	205	Fg.-Nr. →A 138350			0 265 109 492 ^M			
			Fg.-Nr. A 138351→A 322443			0 265 109 497 ^M			
			Fg.-Nr. A 322444→			0 265 109 607 ^M			
430 4MATIC	09.02-09.05	205				0 265 109 743 ^M			
500	10.98-09.05	225	Fg.-Nr. →A 138350		FMS		0 265 109 492 ^M		
			Fg.-Nr. →A 322443		FMS		0 265 109 447 ^M		
			Fg.-Nr. A 138351→A 322443		FMS		0 265 109 497 ^M		
			Fg.-Nr. A 322444→		FMS		0 265 109 609 ^M		
				FMS		0 265 109 607 ^M			
	10.98-08.06	225	Fg.-Nr. →A 138350				0 265 109 492 ^M		
			Fg.-Nr. A 138351→A 322443				0 265 109 497 ^M		
				Fg.-Nr. A 322444→			0 265 109 607 ^M		
	06.00-08.05	225				0 265 109 601 ^M			
500 4MATIC	09.02-09.05	225				0 265 109 743 ^M			
600	08.99-08.02	270	Fg.-Nr. →A 322443		FMS		0 265 109 447 ^M		
					FMS		0 265 109 497 ^M		
			Fg.-Nr. A 322444→		FMS		0 265 109 609 ^M		
				FMS		0 265 109 607 ^M			
		08.99-08.05	270				0 265 109 601 ^M		
	09.02-01.06	368				0 265 109 745 ^M			
	55 AMG, KOMPRESSOR	09.00-08.06	265/368				0 265 005 258		
	65 AMG	02.04-08.06	450				0 265 005 258		
280	01.99-08.02	150	Fg.-Nr. →A 138350				0 265 005 201		
	01.99-08.05	150					0 265 005 258		
320	10.98-08.02	165	Fg.-Nr. →A 138350				0 265 005 201		
			Fg.-Nr. A138351→				0 265 005 258		
320 CDI	06.99-08.05	145/150				0 265 005 258			
350, 4MATIC	09.02-08.06	180				0 265 005 258			
400 CDI	06.99-08.05	184/191				0 265 005 258			

		S							
430		10.98-01.06	205	Fg.-Nr. →A 138350			0 265 005 201		
				Fg.-Nr. A138351→			0 265 005 258		
430 4MATIC		09.02-09.05	205				0 265 005 258		
500		10.98-08.06	225	Fg.-Nr. →A 138350			0 265 005 201		
				Fg.-Nr. A138351→			0 265 005 258		
500 4MATIC		09.02-09.05	225				0 265 005 258		
600		08.99-01.06	270/368				0 265 005 258		
 55 AMG, KOMPRESSOR		09.00-08.06	265/368				0 265 005 303		
65 AMG		02.04-08.06	450				0 265 005 303		
280		01.99-08.05	150				0 265 005 303		
320, CDI		10.98-08.05	145/150/165				0 265 005 303		
350, 4MATIC		09.02-08.06	180				0 265 005 303		
400 CDI		06.99-08.05	184/191				0 265 005 303		
430, 4MATIC		10.98-01.06	205				0 265 005 303		
500, 4MATIC		10.98-08.06	225				0 265 005 303		
600		08.99-01.06	270/368				0 265 005 303		
Serie S [222]									
									
 63 AMG, 4MATIC		08.13→	430				0 265 005 749		
65 AMG		10.13→	463				0 265 005 749		
300 BlueTec Hybrid		02.14→	150-170				0 265 005 749		
400, 4MATIC		05.13→	225/245				0 265 005 749		
500, Hybrid, Maybach, 4MATIC		05.13→	245/335				0 265 005 749		
600, Maybach		02.14→	390				0 265 005 749		
Serie SL [129]									
									
 280		07.93-05.98	142	Fg.-Nr. →F 102744	JBH		0 986 480 895	19	
				Fg.-Nr. F 102745→F 148143	JBH		0 986 480 723	15,4	
320		07.93-05.98	170	Fg.-Nr. →F 102744	JBH		0 986 480 895	19	
				Fg.-Nr. F 102745→F 148143	JBH		0 986 480 723	15,4	
		09.93-09.97	170	Fg.-Nr. F 102745→	JBH		0 986 480 723	15,4	
500		07.93-09.97	235-240	Fg.-Nr. F 102745→	JBH		0 986 480 723	15,4	
		07.93-09.04	235-240	Fg.-Nr. →F 102744	JBH		0 986 480 895	19	
		09.93-05.98	235-240	Fg.-Nr. F 102745→F 148143	JBH		0 986 480 723	15,4	
600		07.93-05.98	290	Fg.-Nr. →F 102744			0 986 480 896	26	
 280		07.93-08.01	142/150				0 986 486 043	19	
 280		07.93-08.01	142/150				0 986 486 535	23,81	
 60 AMG		07.93-06.98	280	Fg.-Nr. →F125157, Komp.Nr. Code 806,			0 265 217 004 ^K		
				Komp.Nr. Code 805			0 265 217 008 ^K		
				Fg.-Nr. F125158→, Komp.Nr. Code 805,			0 265 217 008 ^K		
				Komp.Nr. Code 806					
280		07.93-08.95	142				0 265 217 004 ^K		
		07.93-05.98	142				0 265 200 027 ^H		
							0 265 202 022 ^M		
		09.95-05.98	142				0 265 217 008 ^K		
		06.98-06.99	150				0 265 202 435 ^M		
		06.98-08.01	150				0 265 202 022 ^M		
							0 265 217 403 ^J		
		07.99-08.01	150				0 265 202 466 ^M		
320		07.93-09.95	170	Fg.-Nr. F102745→			0 265 217 004 ^K		
		07.93-05.98	170				0 265 200 027 ^H		
		09.95-05.98	170				0 265 217 008 ^K		



		S							
◀ MERCEDES-BENZ Serie SL [129]									
320		06.98-06.99	165				0 265	202 435^M	
		06.98-08.01	165				0 265	217 403^J	
		07.99-08.01	165				0 265	202 466^M	
500		07.93-09.04	235-240	Fg.-Nr. →F125157, Komp.Nr. Code 806, Komp.Nr. Code 805			0 265	217 004^K	
		08.95-08.95	235-240	Fg.-Nr. F125158→, Komp.Nr. Code 805, Komp.Nr. Code 806			0 265	217 008^K	
		07.99-09.01	225				0 265	202 023^M	
	MFD	06.98-06.99	225				0 265	202 110^Q	
600		07.93-08.02	290				0 265	202 466^M	
		08.95-09.95	290				0 265	202 022^M	
280		07.93-05.98	142	Fg.-Nr. →F105254			0 265	106 082^J	
		06.98-08.01	150				0 265	109 493^M	
320		07.93-05.98	170	Fg.-Nr. →F105254			0 265	109 052^J	
		06.98-08.01	165				0 265	109 493^M	
500		06.98-09.01	225				0 265	109 052^J	
600		06.98-08.01	290				0 265	109 493^M	
600		07.93-08.02	290				0 265	005 107	
280		06.98-08.01	150				0 265	005 201	
320		06.98-08.01	165				0 265	005 201	
500		06.98-09.01	225				0 265	005 201	
600		07.93-08.02	290				0 265	005 201	
280		06.98-08.01	150	Fg.-Nr. Ident 07/99→			0 265	005 307	
320		06.98-08.01	165	Fg.-Nr. Ident 07/99→			0 265	005 307	
500		06.98-09.01	225	Fg.-Nr. Ident 07/99→			0 265	005 307	
600		08.95-09.95	290				0 265	005 300	
		06.98-08.01	290	Fg.-Nr. Ident 07/99→			0 265	005 307	
Serie SL [230]									
55 AMG		10.01-02.06	368	Fg.-Nr. F 138200→, Komp.Nr. 808			0 265	005 753	
		06.04-02.06	368				0 265	005 753	
		01.06-03.08	380				0 265	005 753	
63 AMG		01.08-12.11	386				0 265	005 727	
65 AMG		09.04-03.08	450	Fg.-Nr. →F 145965, Komp.Nr. 809			0 265	005 753	
		07.07-12.11	450	Fg.-Nr. F 138200→			0 265	005 753	
				Fg.-Nr. F 138200→, Komp.Nr. 808			0 265	005 727	
280		01.08-04.09	170				0 265	005 753	
300		05.09-12.11	170				0 265	005 753	
350		03.03-05.04	180				0 265	005 258	
		06.04-12.05	180				0 265	005 753	
		01.06-12.07	200				0 265	005 753	
		01.08-12.11	232				0 265	005 753	
500		10.01-05.04	225				0 265	005 258	
		06.04-12.05	225				0 265	005 753	
		01.06-03.08	285	Fg.-Nr. →F 145965, Komp.Nr. 809			0 265	005 753	
		07.07-11.12	285	Fg.-Nr. F 138200→, Komp.Nr. 808			0 265	005 753	
600		03.03-05.04	368				0 265	005 258	
		06.04-12.05	368				0 265	005 753	
		01.06-03.08	380	Fg.-Nr. →F 145965, Komp.Nr. 809			0 265	005 753	
		07.07-11.12	380	Fg.-Nr. F 138200→, Komp.Nr. 808			0 265	005 753	



Serie SLK [170]

	200	09.96-09.97	100/135	Fg.-Nr. →F 025730	JBH	0 986 480 722	23,81
	200 KOMPRESSOR	09.97-01.00	100/135	Fg.-Nr. F 025731→	JBH	0 986 480 937	23,8
	230 KOMPRESSOR	09.96-09.97	142	Fg.-Nr. →F 025730	JBH	0 986 480 722	23,81
		09.97-01.00	142	Fg.-Nr. F 025731→	JBH	0 986 480 937	23,8
	32 AMG KOMPRESSOR	06.99-03.04	260			0 986 486 043	19
	200, KOMPRESSOR	09.96-03.04	100/120/135			0 986 486 043	19
	230 KOMPRESSOR	09.96-01.00	142	Get.-Nr. →1 880918		0 986 486 043	19
		02.00-03.04	145			0 986 486 043	19
	320	06.99-03.04	160			0 986 486 043	19
	200, KOMPRESSOR	09.96-01.00	100/135			0 986 486 535	23,81
	230 KOMPRESSOR	09.96-01.00	142			0 986 486 535	23,81
	32 AMG KOMPRESSOR	06.99-03.04	260			0 265 202 451^M	
	200 KOMPRESSOR	02.00-03.04	120			0 265 202 451^M	
	230 KOMPRESSOR	02.00-03.04	145			0 265 202 451^M	
	320	06.99-03.04	160			0 265 202 451^M	

Serie SLK [171]

	200 KOMPRESSOR	04.04-11.10	120/135		LLE	0 986 486 064	19,05
	280	05.05-02.09	170		LLE	0 986 486 064	19,05
	300	03.09-11.10	170		LLE	0 986 486 064	19,05
	350	04.04-02.11	200/224		LLE	0 986 486 064	19,05

Serie SLR (Coupé) [199]

	5.4	04.04-12.09	460/478			0 265 109 509^M	
	5.4 722 Edition						
	5.4	04.04-12.09	460/478			0 265 005 258	
	5.4 722 Edition						

Serie SLR (Roadster) [199]

	5.4	04.07-12.09	460			0 265 109 509^M	

Serie SLR [190]

	AMG GT	10.14→	340/375			0 265 005 749	
	AMG GT S						

Serie V [638]

	200	ABO 04.96-09.03	75/95		JBH	F 026 003 366	23,81
	200 CDI	ABS 04.96-09.03	75/95			0 204 123 367	23,81
	220 CDI	ABO 06.99-09.03	90		JBH	F 026 003 366	23,81
		ABS 06.99-09.03	90			0 204 123 367	23,81
	230	ABO 04.96-09.03	72/105		JBH	F 026 003 366	23,81
	230 TD	ABS 04.96-09.03	72/105			0 204 123 367	23,81
	280	04.96-09.03	128			0 204 123 367	23,81











		S							
◀ MERCEDES-BENZ Serie V [638]									
	200, CDI	04.96-09.03	75/95				0 204 125 556		
	220 CDI	06.99-09.03	90				0 204 125 556		
	230, TD	04.96-09.03	72/105				0 204 125 556		
	280	04.96-09.03	128				0 204 125 556		
	200, CDI	04.96-09.03	75/95				0 986 486 053	19,05	
	220 CDI	06.99-09.03	90				0 986 486 053	19,05	
	230, TD	04.96-09.03	72/105				0 986 486 053	19,05	
	280	04.96-09.03	128				0 986 486 053	19,05	
	200	04.96-09.03	75/95				0 986 486 544	22,2	
	200 CDI						0 986 486 613	36	
	220 CDI	06.99-09.03	90				0 986 486 544	22,2	
							0 986 486 613	36	
	230	04.96-09.03	105				0 986 486 544	22,2	
							0 986 486 613	36	
	230 TD	04.96-09.03	72				0 986 486 544	22,2	
	280	04.96-09.03	128				0 986 486 544	22,2	
							0 986 486 613	36	
	200, CDI	04.96-09.03	75/95				0 204 131 322 ^A		
	220 CDI	06.99-09.03	90				0 204 131 322 ^A		
	230, TD	04.96-09.03	72/105				0 204 131 322 ^A		
	280	04.96-09.03	128				0 204 131 322 ^A		
	200	04.96-09.03	75/95	Fg.-Nr. →280987			0 265 220 491 ^F		
	200 CDI			Fg.-Nr. 280988→			0 265 224 066 ^F		
	220 CDI	06.99-09.03	90	Fg.-Nr. →280987			0 265 220 491 ^F		
				Fg.-Nr. 280988→			0 265 224 066 ^F		
	230	04.96-09.03	105	Fg.-Nr. →280987			0 265 220 491 ^F		
				Fg.-Nr. 280988→			0 265 224 066 ^F		
280		04.96-09.03	128	Fg.-Nr. →280987, 638.294			0 265 220 491 ^F		
				Fg.-Nr. 638.244			1 267 000 933 ^F		
				Fg.-Nr. 280988→, 638.294			0 265 224 064 ^F		
Serie 190 [201]									
	190 E 1.8	09.91-04.94	80			JBH	0 986 480 351	22,22	
	190 E 1.8	09.91-04.94	80				0 986 486 043	19	
	190 E 1.8	09.91-04.94	80				0 986 486 503	23,81	
	190 E 1.8	09.91-04.94	80				0 265 200 027 ^H		
	190 E 1.8	09.91-04.94	80				0 265 101 021 ^H		
Sprinter									
	310 D	09.96-05.01	70				0 204 123 484	23,81	
				Komp.Nr. 500014 06		JBH	F 026 003 484	23,81	
				Komp.Nr. 500014/07,		TNK	F 026 003 370	25,4	
				Komp.Nr. 520107/02					
			Komp.Nr. 512054 01		JBH	0 986 BB3 254	23,81		



		S							
311 CDI		06.01-12.04	80				0 204 123 484		23,81
						JBH,LKW	0 986 480 997		25,4
						JBH	F 026 003 484		23,81
							0 986 480 998		23,81
	ABS	06.01-12.04	80				F 026 003 370		25,4
312 D		08.99-05.01	77/85				0 204 123 484		23,81
						Komp.Nr. 500014 06	JBH	F 026 003 484	23,81
						Komp.Nr. 500014/07, Komp.Nr. 520107/02	TNK	F 026 003 370	25,4
						Komp.Nr. 512054 01	JBH	0 986 BB3 254	23,81
313 CDI		06.01-05.12	95			JBH,LKW	0 986 480 997		25,4
						JBH	F 026 003 484		23,81
							0 986 480 998		23,81
	ABS	06.01-05.12	95				F 026 003 370		25,4
412 D		10.99-05.01	85				0 204 123 484		23,81
						Komp.Nr. 500014 06	JBH	F 026 003 484	23,81
						Komp.Nr. 500014/07, Komp.Nr. 520107/02	TNK	F 026 003 370	25,4
						Komp.Nr. 512054 01	JBH	0 986 BB3 254	23,81
413 CDI		06.01-05.12	95			JBH,LKW	0 986 480 997		25,4
						JBH	F 026 003 484		23,81
							0 986 480 998		23,81
	ABS	06.01-05.12	95				F 026 003 370		25,4
	311 CDI	06.01-12.04	80				0 204 125 741		
	313 CDI	06.01-05.12	95				0 204 125 741		
	413 CDI	06.01-05.12	95				0 204 125 741		
	311 CDI	06.01-12.04	80				0 265 224 092 ^H		
							0 265 225 331 ^M		
						CS2,GS	0 265 224 086 ^F		
						SEG	0 265 224 090 ^F		
						TW	0 265 225 225 ^T		
	313 CDI	06.01-05.12	95				0 265 224 092 ^H		
							0 265 225 331 ^M		
						CS2,GS	0 265 224 086 ^F		
						SEG	0 265 224 090 ^F		
						TW	0 265 225 225 ^T		
	413 CDI	06.01-05.12	95				0 265 224 092 ^H		
							0 265 225 331 ^M		
						CS2,GS	0 265 224 086 ^F		
						SEG	0 265 224 090 ^F		
						TW	0 265 225 225 ^T		
Sprinter [NCV3]									
	209 CDI	04.06-12.09	65			Fg.-Nr. →E 034803, →S 419869, Komp.Nr. Z42	0 204 054 487		
						Fg.-Nr. →S 419869, →E 034803, →N 430984, Komp.Nr. Z42	F 026 003 486	26	
	210 CDI	03.09→	70			TW	F 026 003 486	26	
							0 204 054 487		
	211 CDI	04.06-09.11	80			Fg.-Nr. →E 034803, →S 419869	NON	0 204 054 487	
						Fg.-Nr. →S 419869, →E 034803	ERH	F 026 003 486	26
		06.11→	85			TW	F 026 003 486	26	
							0 204 054 487		
	213 CDI	04.06→	95			Fg.-Nr. →E 034803, →S 419869, Komp.Nr. Z42	0 204 054 487		
						Fg.-Nr. →S 419869, →E 034803, →N 430984, Komp.Nr. Z42	F 026 003 486	26	



		S							
◀ MERCEDES-BENZ Sprinter [NCV3]									
215 CDI	04.06-12.11	110	Fg.-Nr. →E 034803, →S 419869, Komp.Nr. Z42				0 204 054 487		
			Fg.-Nr. →S 419869, →E 034803, →N 430984, Komp.Nr. Z42				F 026 003 486	26	
	06.11→	110			TW		F 026 003 486	26	
							0 204 054 487		
216 216 CDI	09.08→	115/120	Fg.-Nr. →E 034803, →S 419869, Komp.Nr. Z42				0 204 054 487		
			Fg.-Nr. →S 419869, →E 034803, →N 430984, Komp.Nr. Z42				F 026 003 486	26	
218 CDI	04.06-03.09	135	Fg.-Nr. →E 034803, →S 419869, Komp.Nr. Z42				0 204 054 487		
			Fg.-Nr. →S 419869, →E 034803, →N 430984, Komp.Nr. Z42				F 026 003 486	26	
219 CDI	03.09→	140	Fg.-Nr. →E 034803, →S 419869, Komp.Nr. Z42				0 204 054 487		
			Fg.-Nr. →S 419869, →E 034803, →N 430984, Komp.Nr. Z42				F 026 003 486	26	
224	04.06→	190	Fg.-Nr. →E 034803, →S 419869, Komp.Nr. Z42				0 204 054 487		
			Fg.-Nr. →S 419869, →E 034803, →N 430984, Komp.Nr. Z42				F 026 003 486	26	
309 CDI	04.06-12.09	65	Fg.-Nr. →E 034803, →S 419869, Komp.Nr. Z42				0 204 054 487		
			Fg.-Nr. →S 419869, →E 034803, →N 430984, Komp.Nr. Z42				F 026 003 486	26	
310 CDI	03.09→	70	Fg.-Nr. →E 034803, →S 419869, Komp.Nr. Z42				0 204 054 487		
			Fg.-Nr. →S 419869, →E 034803, →N 430984, Komp.Nr. Z42				F 026 003 486	26	
311 CDI	04.06→	80/85	Fg.-Nr. →E 034803, →S 419869, Komp.Nr. Z42				0 204 054 487		
			Fg.-Nr. →S 419869, →E 034803, →N 430984, Komp.Nr. Z42				F 026 003 486	26	
313 CDI	04.06→	95	Fg.-Nr. →E 034803, →S 419869, Komp.Nr. Z42				0 204 054 487		
			Fg.-Nr. →S 419869, →E 034803, →N 430984, Komp.Nr. Z42				F 026 003 486	26	
315 CDI	04.06→	110	Fg.-Nr. →E 034803, →S 419869, Komp.Nr. Z42				0 204 054 487		
			Fg.-Nr. →S 419869, →E 034803, →N 430984, Komp.Nr. Z42				F 026 003 486	26	
316 316 CDI 316 NGT	09.08→	115/120	Fg.-Nr. →E 034803, →S 419869, Komp.Nr. Z42				0 204 054 487		
			Fg.-Nr. →S 419869, →E 034803, →N 430984, Komp.Nr. Z42				F 026 003 486	26	
318 CDI	04.06-03.09	135	Fg.-Nr. →E 034803, →S 419869, Komp.Nr. Z42				0 204 054 487		
			Fg.-Nr. →S 419869, →E 034803, →N 430984, Komp.Nr. Z42				F 026 003 486	26	
319 CDI	03.09→	140	Fg.-Nr. →E 034803, →S 419869, Komp.Nr. Z42				0 204 054 487		
			Fg.-Nr. →S 419869, →E 034803, →N 430984, Komp.Nr. Z42				F 026 003 486	26	
324	04.06→	190	Fg.-Nr. →E 034803, →S 419869, Komp.Nr. Z42				0 204 054 487		
			Fg.-Nr. →S 419869, →E 034803, →N 430984, Komp.Nr. Z42				F 026 003 486	26	
411 CDI	04.06-09.11	80	Fg.-Nr. →S 419869, →E 034803, →N 430984				F 026 003 486	26	
413 CDI	03.09→	95	Fg.-Nr. →S 419869, →E 034803, →N 430984				F 026 003 486	26	
415 CDI	04.06-09.11	110	Fg.-Nr. →S 419869, →E 034803				F 026 003 486	26	
416 CDI	03.09→	120	Fg.-Nr. →S 419869, →E 034803, →N 430984				F 026 003 486	26	
418 CDI	04.06-03.09	135	Fg.-Nr. →S 419869, →E 034803, →N 430984				F 026 003 486	26	

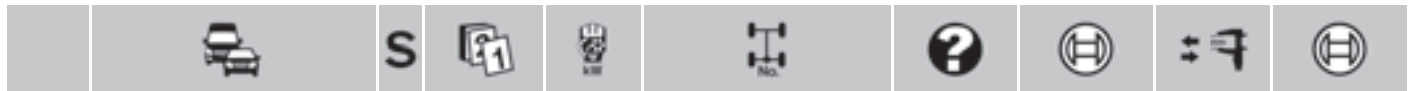

		S							
419 CDI		03.09→	140	Fg.-Nr. →S 419869, →E 034803, →N 430984	F 026 003 486	26			
424		04.06→	190	Fg.-Nr. →S 419869, →E 034803, →N 430984	F 026 003 486	26			
509 CDI		04.06-12.09	65	Fg.-Nr. →S 419869, →E 034803	F 026 003 486	26			
510 CDI		03.09→	70	Fg.-Nr. →S 419869, →E 034803, →N 430984	F 026 003 486	26			
511 CDI		04.06-09.11	80	Fg.-Nr. →S 419869, →E 034803, →N 430984	F 026 003 486	26			
513 CDI		03.09→	95	Fg.-Nr. →S 419869, →E 034803, →N 430984	F 026 003 486	26			
515 CDI		04.06-09.11	110	Fg.-Nr. →S 419869, →E 034803	F 026 003 486	26			
		06.11→	110	Fg.-Nr. →S 419869, →E 034803, →N 430984	F 026 003 486	26			
516, NGT		09.08-09.09	115	Fg.-Nr. →N 430984	F 026 003 486	26			
516 CDI		03.09→	120	Fg.-Nr. →S 419869, →E 034803, →N 430984	F 026 003 486	26			
518 CDI		04.06-03.09	135	Fg.-Nr. →S 419869, →E 034803, →N 430984	F 026 003 486	26			
519 CDI		03.09→	140	Fg.-Nr. →S 419869, →E 034803, →N 430984	F 026 003 486	26			
524		04.06→	190	Fg.-Nr. →S 419869, →E 034803, →N 430984	F 026 003 486	26			
M									
209 CDI		04.06-12.09	65	Fg.-Nr. →S 419869, →E 034803, →N 430984	0 204 054 468				
210 CDI		03.09→	70	TW	0 204 054 468				
211 CDI		04.06-09.11	80	Fg.-Nr. →S 419869, →E 034803	0 204 054 468				
		06.11→	85	TW	0 204 054 468				
213 CDI		04.06-09.11	95	Fg.-Nr. →S 419869, →E 034803, →N 430984	0 204 054 468				
		03.09→	95	Fg.-Nr. →S 419869, →E 034803, →N 430984, Komp.Nr. z42	0 204 054 468				
215 CDI		04.06-12.11	110	Fg.-Nr. →S 419869, →E 034803, →N 430984, Komp.Nr. z42	0 204 054 468				
		06.11→	110	TW	0 204 054 468				
216, CDI		09.08→	115/120	Fg.-Nr. →S 419869, →E 034803, →N 430984	0 204 054 468				
218 CDI		04.06-03.09	135	Fg.-Nr. →S 419869, →E 034803, →N 430984	0 204 054 468				
219 CDI		03.09→	140	Fg.-Nr. →S 419869, →E 034803, →N 430984	0 204 054 468				
224		04.06→	190	Fg.-Nr. →S 419869, →E 034803, →N 430984	0 204 054 468				
309 CDI		04.06-12.09	65	Fg.-Nr. →S 419869, →E 034803, →N 430984	0 204 054 468				
310 CDI		03.09→	70	Fg.-Nr. →S 419869, →E 034803, →N 430984, Komp.Nr. z42	0 204 054 468				
311 CDI		04.06-09.11	80	Fg.-Nr. →S 419869, →E 034803, →N 430984	0 204 054 468				
		06.11→	85	Fg.-Nr. →S 419869, →E 034803, →N 430984, Komp.Nr. z42	0 204 054 468				
313 CDI		04.06-09.11	95	Fg.-Nr. →S 419869, →E 034803, →N 430984	0 204 054 468				
		03.09→	95	Fg.-Nr. →S 419869, →E 034803, →N 430984, Komp.Nr. z42	0 204 054 468				
315 CDI		04.06→	110	Fg.-Nr. →S 419869, →E 034803, →N 430984, Komp.Nr. z42	0 204 054 468				
316, CDI, NGT		09.08→	115/120	Fg.-Nr. →S 419869, →E 034803, →N 430984	0 204 054 468				
318 CDI		04.06-03.09	135	Fg.-Nr. →S 419869, →E 034803, →N 430984	0 204 054 468				
319 CDI		03.09→	140	Fg.-Nr. →S 419869, →E 034803, →N 430984	0 204 054 468				
324		04.06→	190	Fg.-Nr. →S 419869, →E 034803, →N 430984	0 204 054 468				
411 CDI		04.06-09.11	80	Fg.-Nr. →S 419869, →E 034803, →N 430984	0 204 054 468				
413 CDI		03.09→	95	Fg.-Nr. →S 419869, →E 034803, →N 430984	0 204 054 468				
415 CDI		04.06-09.11	110	Fg.-Nr. →S 419869, →E 034803	0 204 054 468				
416 CDI		03.09→	120	Fg.-Nr. →S 419869, →E 034803, →N 430984	0 204 054 468				
418 CDI		04.06-03.09	135	Fg.-Nr. →S 419869, →E 034803, →N 430984	0 204 054 468				
419 CDI		03.09→	140	Fg.-Nr. →S 419869, →E 034803, →N 430984	0 204 054 468				
424		04.06→	190	Fg.-Nr. →S 419869, →E 034803, →N 430984	0 204 054 468				
509 CDI		04.06-12.09	65	Fg.-Nr. →S 419869, →E 034803, →N 430984	0 204 054 468				
510 CDI		03.09→	70	Fg.-Nr. →S 419869, →E 034803, →N 430984	0 204 054 468				
511 CDI		04.06-09.11	80	Fg.-Nr. →S 419869, →E 034803, →N 430984	0 204 054 468				
513 CDI		03.09→	95	Fg.-Nr. →S 419869, →E 034803, →N 430984	0 204 054 468				
515 CDI		04.06-09.11	110	Fg.-Nr. →S 419869, →E 034803	0 204 054 468				
		06.11→	110	Fg.-Nr. →S 419869, →E 034803, →N 430984	0 204 054 468				
516, NGT		09.08-09.09	115	Fg.-Nr. →430984	0 204 054 468				
516 CDI		03.09→	120	Fg.-Nr. →S 419869, →E 034803, →N 430984	0 204 054 468				
518 CDI		04.06-03.09	135	Fg.-Nr. →S 419869, →E 034803, →N 430984	0 204 054 468				
519 CDI		03.09→	140	Fg.-Nr. →S 419869, →E 034803, →N 430984	0 204 054 468				
524		04.06→	190	Fg.-Nr. →S 419869, →E 034803, →N 430984	0 204 054 468				



◀ MERCEDES-BENZ Sprinter [NCV3]

	209 CDI	04.06-01.09	65			0 265 230 402 ^T
	211 CDI	04.06-09.11	80	Fg.-Nr. →S 382754, →E 020197, →N 416268		0 265 230 402 ^T
	213 CDI	04.06-09.11	95	Fg.-Nr. →S 382754, →E 020197, →N 416268		0 265 230 402 ^T
	215 CDI	04.06-12.11	110	Fg.-Nr. →S 382754, →E 020197, →N 416268		0 265 230 402 ^T
	216 , CDI	09.08→	115/120		TW	0 265 230 402 ^T
	218 CDI	04.06-03.09	135	Fg.-Nr. →S 382754, →E 020197, →N 416268		0 265 230 402 ^T
	219 CDI	03.09→	140		TW	0 265 230 402 ^T
	224	04.06→	190		TW	0 265 230 402 ^T
	309 CDI	04.06-12.09	65	Fg.-Nr. →S 382754, →E 020197, →N 416268		0 265 230 402 ^T
	311 CDI	04.06-09.11	80	Fg.-Nr. →S 382754, →E 020197, →N 416268	NAA	0 265 230 402 ^T
				Fg.-Nr. →S 382754, →N 416268	AA	0 265 235 028 ^T
	313 CDI	04.06-09.11	95	Fg.-Nr. →S 382754, →E 020197, →N 416268		0 265 230 402 ^T
	315 CDI	04.06-09.11	110	Fg.-Nr. →S 382754, →E 020197, →N 416268	NAA	0 265 230 402 ^T
				Fg.-Nr. →S 382754, →N 416268	AA	0 265 235 028 ^T
	316 , NGT	09.08→	115		TW	0 265 230 402 ^T
	318 CDI	04.06-03.09	135	Fg.-Nr. →S 382754, →E 020197, →N 416268	NAA	0 265 230 402 ^T
				Fg.-Nr. →S 382754, →N 416268	AA	0 265 235 028 ^T
	324	04.06→	190		TW	0 265 230 402 ^T
	411 CDI	04.06-09.11	80	Fg.-Nr. →N 416268	FUP	0 265 230 404 ^T
				Fg.-Nr. →S 382754, →E 028905	FUP	0 265 230 404 ^T
	415 CDI	04.06-01.09	110	Fg.-Nr. →N 416268	AA,FUP	0 265 235 028 ^T
				Fg.-Nr. →S 382754	FUP,NAA	0 265 230 404 ^T
				Fg.-Nr. →S 382754	AA,FUP	0 265 235 028 ^T
		04.06-09.11	110	Fg.-Nr. →S 382754, →E 028905	FUP,NAA	0 265 230 404 ^T
	418 CDI	04.06-03.09	135	Fg.-Nr. →N 416268	FUP	0 265 230 404 ^T
				Fg.-Nr. →S 382754, →E 028905	FUP	0 265 230 404 ^T
	419 CDI	03.09→	140		TW	0 265 230 404 ^T
	424	04.06→	190		TW	0 265 230 404 ^T
	509 CDI	04.06-12.09	65	Fg.-Nr. →N 416268	FUP	0 265 230 404 ^T
				Fg.-Nr. →S 382754, →E 028905	FUP	0 265 230 404 ^T
	511 CDI	04.06-01.09	80	Fg.-Nr. →N 416268	AA,FUP	0 265 235 028 ^T
				Fg.-Nr. →S 382754	FUP,NAA	0 265 230 404 ^T
				Fg.-Nr. →S 382754	AA,FUP	0 265 235 028 ^T
		04.06-09.11	80	Fg.-Nr. →S 382754, →E 028905	FUP,NAA	0 265 230 404 ^T
	515 CDI	04.06-01.09	110	Fg.-Nr. →N 416268	AA,FUP	0 265 235 028 ^T
				Fg.-Nr. →S 382754	FUP,NAA	0 265 230 404 ^T
				Fg.-Nr. →S 382754	AA,FUP	0 265 235 028 ^T
		04.06-09.11	110	Fg.-Nr. →S 382754, →E 028905	FUP,NAA	0 265 230 404 ^T
	516 , NGT	09.08→	115		TW	0 265 230 404 ^T
	518 CDI	04.06-01.09	135	Fg.-Nr. →N 416268	AA,FUP	0 265 235 028 ^T
				Fg.-Nr. →S 382754	FUP,NAA	0 265 230 404 ^T
				Fg.-Nr. →S 382754	AA,FUP	0 265 235 028 ^T
		04.06-03.09	135	Fg.-Nr. →S 382754, →E 028905	FUP,NAA	0 265 230 404 ^T
	524	04.06→	190		TW	0 265 230 404 ^T
	209 CDI	04.06-12.09	65			0 265 005 774
	210 CDI	03.09→	70		TW	0 265 005 774
	211 CDI	04.06→	80/85		TW	0 265 005 774



213 CDI	04.06-09.11	95			0 265 005 774
	03.09→	95		TW	0 265 005 774
215 CDI	04.06→	110		TW	0 265 005 774
216, CDI	09.08→	115/120		TW	0 265 005 774
218 CDI	04.06-03.09	135			0 265 005 774
219 CDI	03.09→	140		TW	0 265 005 774
224	04.06→	190		TW	0 265 005 774
309 CDI	04.06-12.09	65			0 265 005 774
310 CDI	03.09→	70		TW	0 265 005 774
311 CDI	04.06→	80/85		TW	0 265 005 774
313 CDI	04.06-09.11	95			0 265 005 774
	03.09→	95		TW	0 265 005 774
315 CDI	04.06→	110		TW	0 265 005 774
316, CDI, NGT	09.08→	115/120		TW	0 265 005 774
318 CDI	04.06-03.09	135			0 265 005 774
319 CDI	03.09→	140		TW	0 265 005 774
324	04.06→	190		TW	0 265 005 774
411 CDI	04.06-09.11	80			0 265 005 774
413 CDI	03.09→	95		TW	0 265 005 774
415 CDI	04.06-09.11	110			0 265 005 774
416 CDI	03.09→	120		TW	0 265 005 774
418 CDI	04.06-03.09	135			0 265 005 774
419 CDI	03.09→	140		TW	0 265 005 774
424	04.06→	190		TW	0 265 005 774
509 CDI	04.06-12.09	65			0 265 005 774
510 CDI	03.09→	70		TW	0 265 005 774
511 CDI	04.06-09.11	80			0 265 005 774
513 CDI	03.09→	95		TW	0 265 005 774
515 CDI	04.06-09.11	110			0 265 005 774
	06.11→	110		TW	0 265 005 774
516, CDI, NGT	09.08→	115/120		TW	0 265 005 774
518 CDI	04.06-03.09	135			0 265 005 774
519 CDI	03.09→	140		TW	0 265 005 774
524	04.06→	190		TW	0 265 005 774

Sprinter [T1N]



	208 CDI	04.00-05.06	60		ERH,JBH	0 986 480 997	25,4
					JBH,NON	F 026 003 484	23,81
	208 D	02.95-03.00	58-60		JBH	F 026 003 484	23,81
	210 D	01.97-03.00	75		JBH	F 026 003 484	23,81
	211 CDI	04.00-05.06	80		ERH,JBH	0 986 480 997	25,4
					JBH,NON	F 026 003 484	23,81
	212 D	02.95-03.00	90		JBH	F 026 003 484	23,81
	213 CDI	04.00-05.06	95		ERH,JBH	0 986 480 997	25,4
					JBH,NON	F 026 003 484	23,81
	214	02.95-03.00	105		JBH	F 026 003 484	23,81
		04.00-05.06	105-108		ERH,JBH	0 986 480 997	25,4
					JBH,NON	F 026 003 484	23,81
	214 NGT	04.00-05.06	95		ERH,JBH	0 986 480 997	25,4
					JBH,NON	F 026 003 484	23,81
	216 CDI	04.00-05.06	115		ERH,JBH	0 986 480 997	25,4
					JBH,NON	F 026 003 484	23,81
	308 CDI	04.00-05.06	60		JBH,TW	F 026 003 484	23,81
						0 986 480 997	25,4
						0 986 480 998	23,81
					TW	F 026 003 370	25,4
	308 D	ABO 02.95-03.00	58		JBH	F 026 003 484	23,81
	308 D James Cook	ABS 02.95-03.00	58			F 026 003 370	25,4
	310 D	ABO 01.97-03.00	75		JBH	F 026 003 484	23,81
	310 D James Cook	ABS 01.97-03.00	75			F 026 003 370	25,4



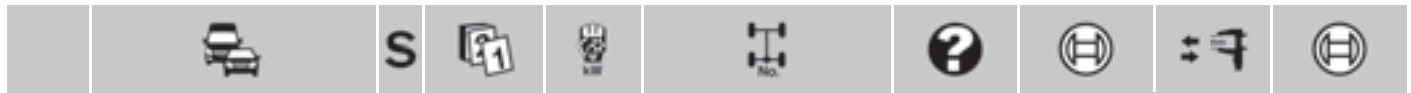

◀ MERCEDES-BENZ Sprinter [T1N]

311 CDI		04.00-05.06	80		JBH,TW	F 026 003 484	23,81
						0 986 480 997	25,4
						0 986 480 998	23,81
		08.02-05.06	80		TW	F 026 003 370	25,4
					ERH,JBH	0 986 480 997	25,4
					JBH,NON	F 026 003 484	23,81
312 D	ABO	02.95-03.00	90		JBH	F 026 003 484	23,81
312 D James Cook	ABS	02.95-03.00	90			F 026 003 370	25,4
313 CDI		04.00-05.06	95		ERH,JBH	0 986 480 997	25,4
313 CDI 4x4					JBH,NON	F 026 003 484	23,81
314	ABO	02.95-08.02	105		JBH	F 026 003 484	23,81
314 James Cook	ABS	02.95-08.02	105			F 026 003 370	25,4
314, James Cook, NGT		04.00-05.06	95/105-108		ERH,JBH	0 986 480 997	25,4
					JBH,NON	F 026 003 484	23,81
316 CDI		04.00-05.06	115		ERH,JBH	0 986 480 997	25,4
316 CDI James Cook					JBH,NON	F 026 003 484	23,81
408 CDI		04.00-05.06	60	Fg.-Nr. →R400726, →A937136	JBH	F 026 003 484	23,81
				Fg.-Nr. R 400727→, A 906426→	JBH	0 986 480 997	25,4
408 D		02.95-03.00	58	Fg.-Nr. →P 707202	JBH	F 026 003 484	23,81
				Fg.-Nr. P 707203→		F 026 003 370	25,4
410 D		01.97-03.00	75	Fg.-Nr. →P 707202	JBH	F 026 003 484	23,81
				Fg.-Nr. P 707203→		F 026 003 370	25,4
411 CDI		04.00-05.06	80	Fg.-Nr. →R400726, →A937136	JBH	F 026 003 484	23,81
				Fg.-Nr. R 400727→, A 906426→	JBH	0 986 480 997	25,4
412 D		02.95-03.00	90	Fg.-Nr. →P 707202	JBH	F 026 003 484	23,81
				Fg.-Nr. P 707203→		F 026 003 370	25,4
413 CDI		04.00-05.06	95	Fg.-Nr. →R400726, →A937136	JBH	F 026 003 484	23,81
				Fg.-Nr. R 400727→, A 906426→	JBH	0 986 480 997	25,4
414		02.95-03.00	105	Fg.-Nr. →P 707202	JBH	F 026 003 484	23,81
				Fg.-Nr. P 707203→		F 026 003 370	25,4
		04.00-05.06	105-108	Fg.-Nr. →R400726, →A937136	JBH	F 026 003 484	23,81
				Fg.-Nr. R400727→, A937137→	JBH,NON	0 986 480 998	23,81
416 CDI		04.00-05.06	115	Fg.-Nr. →R400726, →A937136	JBH	F 026 003 484	23,81
				Fg.-Nr. R 400727→, A 906426→	JBH	0 986 480 997	25,4
208 CDI		04.00-05.06	60	Fg.-Nr. →R 400726, →A 905511		0 204 125 741	
211 CDI		04.00-05.06	80	Fg.-Nr. →R 400726, →A 905511		0 204 125 741	
213 CDI		04.00-05.06	95	Fg.-Nr. →R 400726, →A 905511		0 204 125 741	
214, NGT		04.00-05.06	95/105-108	Fg.-Nr. →R 400726, →A 905511		0 204 125 741	
216 CDI		04.00-05.06	115	Fg.-Nr. →R 400726, →A 905511		0 204 125 741	
308 CDI		04.00-05.06	60		TW	0 204 125 741	
311 CDI		04.00-05.06	80		TW	0 204 125 741	
		08.02-05.06	80	Fg.-Nr. R400727→, A905512→		0 204 125 741	
313 CDI, CDI 4x4		04.00-05.06	95	Fg.-Nr. R400727→, A905512→		0 204 125 741	
314, James Cook, NGT		02.95-05.06	95/105-108	Fg.-Nr. R400727→, A905512→		0 204 125 741	
316 CDI, CDI James Cook		04.00-05.06	115	Fg.-Nr. R400727→, A905512→		0 204 125 741	
408 CDI		04.00-05.06	60	Fg.-Nr. →R 400726, →A 906425		0 204 125 741	
411 CDI		04.00-05.06	80	Fg.-Nr. →R 400726, →A 906425		0 204 125 741	
413 CDI		04.00-05.06	95	Fg.-Nr. →R 400726, →A 906425		0 204 125 741	
414		04.00-05.06	105-108	Fg.-Nr. →R 400726, →A 906425		0 204 125 741	
416 CDI		04.00-05.06	115	Fg.-Nr. →R 400726, →A 906425		0 204 125 741	
		10.04-05.06	115			0 204 125 741	



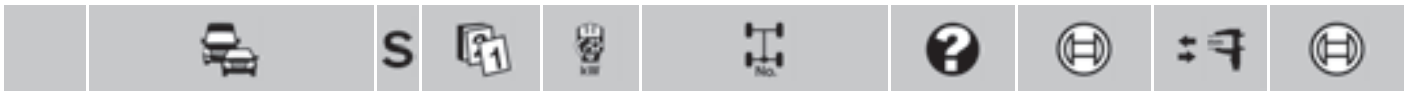

	208 CDI, D	02.95-05.06	58-60		0 986 486 053	19,05
	210 D	01.97-03.00	75		0 986 486 053	19,05
	211 CDI	04.00-05.06	80		0 986 486 053	19,05
	212 D	02.95-03.00	90		0 986 486 053	19,05
	213 CDI	04.00-05.06	95		0 986 486 053	19,05
	214 , NGT	02.95-05.06	95/105		0 986 486 053	19,05
	216 CDI	04.00-05.06	115	Komp.Nr. 500011/01	0 986 486 053	19,05
	308 CDI, D, D James Cook	02.95-05.06	58/60		0 986 486 053	19,05
	310 D, D James Cook	01.97-03.00	75		0 986 486 053	19,05
	311 CDI	04.00-05.06	80		0 986 486 053	19,05
	312 D, D James Cook	02.95-03.00	90		0 986 486 053	19,05
	313 CDI, CDI 4x4	04.00-05.06	95		0 986 486 053	19,05
	314 , James Cook, NGT	02.95-05.06	95/105-108		0 986 486 053	19,05
	316 CDI, CDI James Cook	04.00-05.06	115		0 986 486 053	19,05
	408 CDI, D	02.95-05.06	58/60		0 986 486 053	19,05
	410 D	01.97-03.00	75		0 986 486 053	19,05
	411 CDI	04.00-05.06	80		0 986 486 053	19,05
	412 D	02.95-03.00	90		0 986 486 053	19,05
	413 CDI	04.00-05.06	95		0 986 486 053	19,05
	414	02.95-05.06	105-108		0 986 486 053	19,05
	416 CDI	04.00-05.06	115		0 986 486 053	19,05
	616 CDI	02.01-05.06	115		0 986 486 053	19,05

	208 D	02.95-03.00	58-60	Komp.Nr. 504099/01	0 986 486 546	22,2
	210 D	01.97-03.00	75	Komp.Nr. 504099/01	0 986 486 546	22,2
	212 D	02.95-03.00	90	Komp.Nr. 504099/01	0 986 486 546	22,2
	214 , NGT	04.00-05.06	95/105-108	Komp.Nr. 504099/01	0 986 486 546	22,2
	308 D, D James Cook	02.95-03.00	58		0 986 486 546	22,2
	310 D, D James Cook	01.97-03.00	75		0 986 486 546	22,2
	312 D, D James Cook	02.95-03.00	90		0 986 486 546	22,2
	314 , NGT	04.00-05.06	95/105-108		0 986 486 546	22,2
	408 D	02.95-03.00	58	Komp.Nr. 504099/01	0 986 486 546	22,2
	410 D	01.97-03.00	75	Komp.Nr. 504099/01	0 986 486 546	22,2
	412 D	02.95-03.00	90	Komp.Nr. 504099/01	0 986 486 546	22,2
	414	04.00-05.06	105-108	Komp.Nr. 504099/01	0 986 486 546	22,2

	208 CDI, D	02.95-05.06	58-60		0 204 131 248 ^A	
	210 D	01.97-03.00	75		0 204 131 248 ^A	
	211 CDI	04.00-05.06	80		0 204 131 248 ^A	
	212 D	02.95-03.00	90		0 204 131 248 ^A	
	213 CDI	04.00-05.06	95		0 204 131 248 ^A	
	214 , NGT	02.95-05.06	95/105-108		0 204 131 248 ^A	
	216 CDI	04.00-05.06	115		0 204 131 248 ^A	
	308 CDI	04.00-05.06	60	TW	0 204 131 248 ^A	
					0 204 131 249 ^A	
					0 204 131 250 ^A	
	308 D	02.95-03.00	58	Komp.Nr. 500042/02/04, TNK	0 204 131 248 ^A	
	308 D James Cook			Komp.Nr. 500042/05/50		
				Komp.Nr. 500042/06 TNK	0 204 131 249 ^A	
				Komp.Nr. 500042/07 TNK	0 204 131 250 ^A	
	310 D	01.97-03.00	75	Komp.Nr. 500042/02/04, TNK	0 204 131 248 ^A	
	310 D James Cook			Komp.Nr. 500042/05/50		
				Komp.Nr. 500042/06 TNK	0 204 131 249 ^A	
				Komp.Nr. 500042/07 TNK	0 204 131 250 ^A	
	311 CDI	04.00-05.06	80	TW	0 204 131 248 ^A	
					0 204 131 249 ^A	
					0 204 131 250 ^A	
		08.02-05.06	80	Komp.Nr. 500042/02/04, TNK	0 204 131 248 ^A	
				Komp.Nr. 500042/05/50		
				Komp.Nr. 500042/06 TNK	0 204 131 249 ^A	
				Komp.Nr. 500042/07 TNK	0 204 131 250 ^A	



◀ MERCEDES-BENZ Sprinter [T1N]										
312 D		02.95-03.00	90		Komp.Nr. 500042/02/04,	TNK	0 204 131 248 ^A			
312 D James Cook					Komp.Nr. 500042/05/50					
					Komp.Nr. 500042/06	TNK	0 204 131 249 ^A			
					Komp.Nr. 500042/07	TNK	0 204 131 250 ^A			
313 CDI		04.00-05.06	95		Komp.Nr. 500042/02/04,	TNK	0 204 131 248 ^A			
					Komp.Nr. 500042/05/50					
313 CDI 4x4					Komp.Nr. 500042/06	TNK	0 204 131 249 ^A			
					Komp.Nr. 500042/07	TNK	0 204 131 250 ^A			
314		02.95-05.06	95/105-108		Komp.Nr. 500042/02/04,	TNK	0 204 131 248 ^A			
314 James Cook					Komp.Nr. 500042/05/50					
314 NGT					Komp.Nr. 500042/06	TNK	0 204 131 249 ^A			
					Komp.Nr. 500042/07	TNK	0 204 131 250 ^A			
316 CDI		04.00-05.06	115		Komp.Nr. 500042/02/04,	TNK	0 204 131 248 ^A			
316 CDI James Cook					Komp.Nr. 500042/05/50					
					Komp.Nr. 500042/06	TNK	0 204 131 249 ^A			
					Komp.Nr. 500042/07	TNK	0 204 131 250 ^A			
408 CDI	ABO	04.00-05.01	60		Komp.Nr. 500042/03	TNK	0 204 131 251 ^A			
					Komp.Nr. 500042/08	TNK	0 204 031 068 ^A			
		06.01-05.06	60		Komp.Nr. 500042/03	TNK	0 204 031 186 ^A			
					Komp.Nr. 500042/08	TNK	0 204 031 187 ^A			
	ABS	04.00-05.06	60		Komp.Nr. 500042/05	TNK	0 204 131 248 ^A			
408 D		02.95-03.00	58		Fg.-Nr. P 516915→,	TNK	0 204 131 251 ^A			
					Komp.Nr. 500042/03					
					Komp.Nr. 500042/02/04,	TNK	0 204 131 248 ^A			
					Komp.Nr. 500042/05/50					
					Komp.Nr. 500042/08	TNK	0 204 031 068 ^A			
410 D		01.97-03.00	75		Komp.Nr. 500042/02/04,	TNK	0 204 131 248 ^A			
					Komp.Nr. 500042/05/50					
					Komp.Nr. 500042/08	TNK	0 204 031 068 ^A			
411 CDI	ABO	04.00-05.01	80		Komp.Nr. 500042/03	TNK	0 204 131 251 ^A			
					Komp.Nr. 500042/08	TNK	0 204 031 068 ^A			
		06.01-05.06	80		Komp.Nr. 500042/03	TNK	0 204 031 186 ^A			
					Komp.Nr. 500042/08	TNK	0 204 031 187 ^A			
	ABS	04.00-05.06	80		Komp.Nr. 500042/05	TNK	0 204 131 248 ^A			
412 D		02.95-03.00	90		Fg.-Nr. P 516915→,	TNK	0 204 131 251 ^A			
					Komp.Nr. 500042/03					
					Komp.Nr. 500042/02/04,	TNK	0 204 131 248 ^A			
					Komp.Nr. 500042/05/50					
					Komp.Nr. 500042/08	TNK	0 204 031 068 ^A			
413 CDI	ABO	04.00-05.01	95		Komp.Nr. 500042/03	TNK	0 204 131 251 ^A			
					Komp.Nr. 500042/08	TNK	0 204 031 068 ^A			
		06.01-05.06	95		Komp.Nr. 500042/03	TNK	0 204 031 186 ^A			
					Komp.Nr. 500042/08	TNK	0 204 031 187 ^A			
	ABS	04.00-05.06	95		Komp.Nr. 500042/05	TNK	0 204 131 248 ^A			
414		02.95-03.00	105		Fg.-Nr. P 516915→,	TNK	0 204 131 251 ^A			
					Komp.Nr. 500042/03					
					Komp.Nr. 500042/02/04,	TNK	0 204 131 248 ^A			
					Komp.Nr. 500042/05/50					
					Komp.Nr. 500042/08	TNK	0 204 031 068 ^A			
	ABO	04.00-05.01	105-108		Komp.Nr. 500042/03	TNK	0 204 131 251 ^A			
					Komp.Nr. 500042/08	TNK	0 204 031 068 ^A			
		06.01-05.06	105-108		Komp.Nr. 500042/03	TNK	0 204 031 186 ^A			
					Komp.Nr. 500042/08	TNK	0 204 031 187 ^A			
	ABS	04.00-05.06	105-108		Komp.Nr. 500042/05	TNK	0 204 131 248 ^A			
416 CDI	ABO	04.00-05.01	115		Komp.Nr. 500042/03	TNK	0 204 131 251 ^A			
					Komp.Nr. 500042/08	TNK	0 204 031 068 ^A			
		06.01-05.06	115		Komp.Nr. 500042/03	TNK	0 204 031 186 ^A			
					Komp.Nr. 500042/08	TNK	0 204 031 187 ^A			
	ABS	04.00-05.06	115		Komp.Nr. 500042/05	TNK	0 204 131 248 ^A			
208 CDI		04.00-05.06	60			CS2,GS	0 265 224 086 ^F			
						SEG	0 265 224 090 ^F			

		S							
208 D		02.95-03.00	58-60	Fg.-Nr. P718187→, R000001→	TNK		0 265 220 489 ^E		
210 D		01.97-03.00	75	Fg.-Nr. P718187→, R000001→	TNK		0 265 220 489 ^E		
211 CDI		04.00-05.06	80		CS2,GS		0 265 224 086 ^F		
					SEG		0 265 224 090 ^F		
					Fg.-Nr. →R 636248, →A 918343		0 265 225 225 ^T		
				Fg.-Nr. R 636249→, A 918344→			0 265 225 300 ^T		
212 D		02.95-03.00	90	Fg.-Nr. P718187→, R000001→	TNK		0 265 220 489 ^E		
213 CDI		04.00-05.06	95		CS2,GS		0 265 224 086 ^F		
					SEG		0 265 224 090 ^F		
214		02.95-05.06	95/105-108	Fg.-Nr. P718187→, R000001→	TNK		0 265 220 489 ^E		
214 NGT									
216 CDI		04.00-05.06	115		CS2,GS		0 265 224 086 ^F		
					SEG		0 265 224 090 ^F		
308 CDI		04.00-05.06	60		CS2,GS,NON		0 265 224 086 ^F		
					ERH		0 265 224 092 ^F		
					NON,SEG		0 265 224 090 ^F		
					TW		0 265 225 225 ^T		
							0 265 225 300 ^T		
							0 265 225 302 ^T		
							0 265 225 331 ^T		
308 D, D James Cook		02.95-03.00	58	Fg.-Nr. P718187→, R000001→			0 265 220 489 ^E		
310 D, D James Cook		01.97-03.00	75	Fg.-Nr. P718187→, R000001→			0 265 220 489 ^E		
311 CDI		04.00-05.06	80		CS2,GS,NON		0 265 224 086 ^F		
					ERH		0 265 224 092 ^F		
					NON,SEG		0 265 224 090 ^F		
					TW		0 265 225 225 ^T		
							0 265 225 300 ^T		
							0 265 225 302 ^T		
							0 265 225 331 ^T		
		08.02-05.06	80		ERH		0 265 225 331 ^T		
				Fg.-Nr. →R636248	NON		0 265 225 225 ^T		
				Fg.-Nr. R337627→, A901274→	TNK		0 265 225 302 ^T		
				Fg.-Nr. R636249→	NON		0 265 225 300 ^T		
312 D, D James Cook		02.95-03.00	90	Fg.-Nr. P718187→, R000001→			0 265 220 489 ^E		
313 CDI		04.00-05.06	95		CS2,GS,NON		0 265 224 086 ^F		
					ERH		0 265 224 092 ^F		
313 CDI 4x4							0 265 225 331 ^T		
					NON,SEG		0 265 224 090 ^F		
				Fg.-Nr. →R636248	NON		0 265 225 225 ^T		
				Fg.-Nr. R337627→, A901274→	TNK		0 265 225 302 ^T		
				Fg.-Nr. R636249→	NON		0 265 225 300 ^T		
314		02.95-05.06	105-108				0 265 224 088 ^F		
314 James Cook					ERH		0 265 225 331 ^T		
					GS		0 265 225 304 ^T		
				Fg.-Nr. P718187→, R000001→			0 265 220 489 ^E		
314 NGT		04.00-05.06	95		CS2,GS,NON		0 265 224 086 ^F		
					ERH		0 265 224 092 ^F		
							0 265 225 331 ^T		
					GS		0 265 225 304 ^T		
				Fg.-Nr. P718187→, R000001→			0 265 220 489 ^E		
316 CDI		04.00-05.06	115		GS,NON		0 265 225 302 ^T		
		10.04-05.06	115	Fg.-Nr. R337627→, A901274→	TNK		0 265 225 302 ^T		
316 CDI James Cook		04.01-05.06	115	Fg.-Nr. R337627→, A901274→	TNK		0 265 225 302 ^T		



Mercedes-Benz Sprinter [T1N]								
316 CDI	04.00-05.06	115				CS2,GS,NON	0 265 224 086 ^F	
316 CDI James Cook						ERH	0 265 224 092 ^F	
							0 265 225 331 ^T	
						NON,SEG	0 265 224 090 ^F	
	04.01-05.06	115	Fg.-Nr. →R636248			NON	0 265 225 225 ^T	
			Fg.-Nr. R636249→			NON	0 265 225 300 ^T	
408 CDI	04.00-05.06	60				CS2,GS	0 265 224 086 ^F	
						SEG	0 265 224 090 ^F	
408 D	02.95-03.00	58	Fg.-Nr. P718187→, R000001→			TNK	0 265 220 489 ^E	
410 D	01.97-03.00	75	Fg.-Nr. P718187→, R000001→			TNK	0 265 220 489 ^E	
411 CDI	04.00-05.06	80				CS2,GS	0 265 224 086 ^F	
						SEG	0 265 224 090 ^F	
412 D	02.95-03.00	90	Fg.-Nr. P718187→, R000001→			TNK	0 265 220 489 ^E	
413 CDI	04.00-05.06	95				CS2,GS	0 265 224 086 ^F	
						SEG	0 265 224 090 ^F	
414	02.95-03.00	105	Fg.-Nr. P718187→, R000001→			TNK	0 265 220 489 ^E	
	04.00-05.06	105-108					0 265 224 088 ^F	
416 CDI	04.00-05.06	115				CS2,GS	0 265 224 086 ^F	
						SEG	0 265 224 090 ^F	
616 CDI	02.01-05.06	115					0 265 224 082 ^M	
Vaneo [414]								
	1.6	02.02-08.05	60/75			FK	0 986 486 108	15,8
	1.7 CDI	02.02-08.05	55/67			FK	0 986 486 108	15,8
	1.9	02.02-08.05	92			FK	0 986 486 108	15,8
	1.6	02.02-08.05	60/75				0 986 486 587	26
	1.7 CDI	02.02-08.05	55/67				0 986 486 587	26
	1.9	02.02-08.05	92				0 986 486 587	26
	1.6	02.02-08.05	60/75				0 265 202 463 ^T	
	1.7 CDI	02.02-08.05	55/67				0 265 202 463 ^T	
	1.9	02.02-08.05	92				0 265 202 463 ^T	
	1.6	02.02-08.05	60/75				0 265 109 617 ^M	
	1.7 CDI	02.02-08.05	55/67				0 265 109 617 ^M	
	1.9	02.02-08.05	92				0 265 109 617 ^M	
	1.6	02.02-08.05	60/75				0 265 005 258	
	1.7 CDI	02.02-08.05	55/67				0 265 005 258	
	1.9	02.02-08.05	92				0 265 005 258	
	1.6	02.02-08.05	60/75				0 265 005 303	
	1.7 CDI	02.02-08.05	55/67				0 265 005 303	
	1.9	02.02-08.05	92				0 265 005 303	
Viano [639]								
	2.0 CDI	09.03-10.06	80				0 204 123 643	23,8
		11.06-08.10	85	Fg.-Nr. →3558104			0 204 123 643	23,8
	2.2 CDI	09.03-12.10	110	Fg.-Nr. →3558104			0 204 123 643	23,8
	3.0 CDI	04.06-08.10	150	Fg.-Nr. →3558104			0 204 123 643	23,8
	3.2	09.03-12.07	140/160				0 204 123 643	23,8
	3.5	09.07→	190	Fg.-Nr. →3558104			0 204 123 643	23,8
	3.7	06.04-08.07	170				0 204 123 643	23,8



	2.0 CDI	09.03-10.06	80			0 204 051 088	
		11.06-08.10	85	Fg.-Nr. →3558104		0 204 051 088	
	2.2 CDI	09.03-12.10	110	Fg.-Nr. →3558104		0 204 051 088	
	3.0 CDI	04.06-08.10	150	Fg.-Nr. →3558104		0 204 051 088	
	3.2	09.03-12.07	140/160			0 204 051 088	
	3.5	09.07→	190	Fg.-Nr. →3558104		0 204 051 088	
	3.7	06.04-08.07	170			0 204 051 088	

	2.0 CDI	09.03-10.06	80		AA	0 265 235 001 ^T	
				Fg.-Nr. →195055	NAA	0 265 225 347 ^T	
				Fg.-Nr. 195056→	NAA	0 265 235 168 ^T	
		11.06-08.10	85	Fg.-Nr. →3555131,	AA	0 265 230 408 ^T	
				Komp.Nr. CL9/XM0	NAA	0 265 230 406 ^T	
	2.2 CDI	09.03-12.10	110	Fg.-Nr. →195055,	NAA	0 265 225 347 ^T	
				Komp.Nr. CL9/XM0			
				Fg.-Nr. →3555131,	AA	0 265 230 408 ^T	
				Komp.Nr. CL9/XM0			
				Fg.-Nr. 195056→3555131,	NAA	0 265 230 406 ^T	
			Komp.Nr. CL9/XM0				
3.0 CDI	04.06-08.10	150	Fg.-Nr. →3555131, Komp.Nr. CL9/XM0		0 265 230 406 ^T		
3.2	09.03-12.07	140/160			0 265 235 168 ^T		
3.5	09.07→	190		TW	0 265 230 406 ^T		
3.7	06.04-08.07	170			0 265 235 168 ^T		

	2.0 CDI	09.03-10.06	80	Fg.-Nr. →195055		0 265 005 258	
				Fg.-Nr. 195056→		0 265 005 628	
		11.06→	85/100			0 265 005 774	
	2.2 CDI	09.03-12.10	110	Fg.-Nr. →195055		0 265 005 258	
				Fg.-Nr. 195056→		0 265 005 774	
		07.10→	120			0 265 005 774	
	3.0 CDI	04.06→	150/165			0 265 005 774	
	3.2	09.03-12.07	140/160	Fg.-Nr. →195055		0 265 005 258	
				Fg.-Nr. 195056→		0 265 005 628	
	3.5	09.07→	190			0 265 005 774	
3.7	06.04-08.07	170	Fg.-Nr. →195055		0 265 005 258		
			Fg.-Nr. 195056→		0 265 005 628		

	2.0 CDI	09.03-10.06	80			0 265 005 429	
		11.06→	85/100		TW	0 265 005 429	
	2.2 CDI	09.03→	110/120		TW	0 265 005 429	
	3.0 CDI	04.06→	150/165		TW	0 265 005 429	
	3.2	09.03-12.07	140/160			0 265 005 429	
	3.5	09.07→	190		TW	0 265 005 429	
	3.7	06.04-08.07	170			0 265 005 429	

Vito [638]

	108 CDI	ABO	11.95-09.03	60		JBH	F 026 003 366	23,81
	108 D	ABS	11.95-09.03	60			0 204 123 367	23,81
	110 CDI	ABO	11.95-09.03	72/75		JBH	F 026 003 366	23,81
	110 D	ABS	11.95-09.03	72/75			0 204 123 367	23,81
	112 CDI	ABO	04.99-09.03	90		JBH	F 026 003 366	23,81
		ABS	04.99-09.03	90			0 204 123 367	23,81
	113	ABO	11.95-09.03	95/100		JBH	F 026 003 366	23,81
		ABS	11.95-09.03	95/100			0 204 123 367	23,81
	114	ABO	11.95-09.03	105		JBH	F 026 003 366	23,81
		ABS	11.95-09.03	105			0 204 123 367	23,81

	108 CDI, D		11.95-09.03	60			0 204 125 556	
	110 CDI, D		11.95-09.03	72/75			0 204 125 556	
	112 CDI		04.99-09.03	90			0 204 125 556	



		S							
◀ MERCEDES-BENZ Vito [638]									
	113	11.95-09.03	95/100				0 204 125 556		
	114	11.95-09.03	105				0 204 125 556		
	108 CDI, D	11.95-09.03	60				0 986 486 053	19,05	
	110 CDI, D	11.95-09.03	72/75				0 986 486 053	19,05	
	112 CDI	04.99-09.03	90				0 986 486 053	19,05	
	113	11.95-09.03	95/100				0 986 486 053	19,05	
	114	11.95-09.03	105				0 986 486 053	19,05	
	108 CDI	04.99-09.03	60				0 986 486 613	36	
	108 CDI, D	11.95-09.03	60				0 986 486 544	22,2	
	110 CDI	04.99-09.03	75				0 986 486 544	22,2	
							0 986 486 613	36	
	110 D	11.95-09.03	72				0 986 486 544	22,2	
	112 CDI	04.99-09.03	90				0 986 486 544	22,2	
							0 986 486 613	36	
	113	11.95-09.03	95				0 986 486 544	22,2	
			100				0 986 486 613	36	
	114	11.95-09.03	105				0 986 486 544	22,2	
							0 986 486 613	36	
	108 CDI, D	11.95-09.03	60				0 204 131 322 ^A		
	110 CDI, D	11.95-09.03	72/75				0 204 131 322 ^A		
	112 CDI	04.99-09.03	90				0 204 131 322 ^A		
	113	11.95-09.03	95/100				0 204 131 322 ^A		
	114	11.95-09.03	105				0 204 131 322 ^A		
	108 CDI	04.99-09.03	60	Fg.-Nr. →280987			0 265 220 491 ^F		
				Fg.-Nr. 280988→			0 265 224 066 ^F		
	110 CDI	04.99-09.03	75	Fg.-Nr. →280987			0 265 220 491 ^F		
				Fg.-Nr. 280988→			0 265 224 066 ^F		
	112 CDI	04.99-09.03	90	Fg.-Nr. →280987			0 265 220 491 ^F		
				Fg.-Nr. 280988→			0 265 224 066 ^F		
	113	11.95-09.03	95	Fg.-Nr. →280987			0 265 220 491 ^F		
				Fg.-Nr. 280988→			0 265 224 066 ^F		
	114	11.95-09.03	105	Fg.-Nr. →280987			0 265 220 491 ^F		
				Fg.-Nr. 280988→			0 265 224 066 ^F		
Vito [639]									
	109 CDI	10.03-10.06	65				0 204 123 643	23,8	
		11.06-07.10	70	Fg.-Nr. →3558104			0 204 123 643	23,8	
	111 CDI	10.03-07.10	80				0 204 123 643	23,8	
		11.06-07.10	85	Fg.-Nr. →3558104			0 204 123 643	23,8	
	115 CDI	10.03-07.10	110	Fg.-Nr. →3558104			0 204 123 643	23,8	
	119	10.03-12.10	140	Fg.-Nr. →3558104			0 204 123 643	23,8	
	120 CDI	04.06-07.10	150	Fg.-Nr. →3558104			0 204 123 643	23,8	
	122	10.03-12.10	160	Fg.-Nr. →3558104			0 204 123 643	23,8	
	123	06.04-08.07	170				0 204 123 643	23,8	
	126	09.07→	190	Fg.-Nr. →3558104			0 204 123 643	23,8	
	109 CDI	10.03-10.06	65				0 204 051 088		
		11.06-07.10	70	Fg.-Nr. →3558104			0 204 051 088		
	111 CDI	10.03-07.10	80				0 204 051 088		
		11.06-07.10	85	Fg.-Nr. →3558104			0 204 051 088		
	115 CDI	10.03-07.10	110	Fg.-Nr. →3558104			0 204 051 088		
	119	10.03-12.10	140	Fg.-Nr. →3558104			0 204 051 088		
	120 CDI	04.06-07.10	150	Fg.-Nr. →3558104			0 204 051 088		
	122	10.03-12.10	160	Fg.-Nr. →3558104			0 204 051 088		
	123	06.04-08.07	170				0 204 051 088		
	126	09.07→	190	Fg.-Nr. →3558104			0 204 051 088		





	109 CDI	10.03-10.06	65	Fg.-Nr. →195055 Fg.-Nr. 195056 →		0 265 225 347 ^T 0 265 235 168 ^T	
		11.06-07.10	70			0 265 230 406 ^T	
	111 CDI	10.03-07.10	80		AA	0 265 235 001 ^T	
				Fg.-Nr. →195055 Fg.-Nr. 195056 →	NAA NAA	0 265 225 347 ^T 0 265 235 168 ^T	
		11.06-07.10	85	Fg.-Nr. →3555131, Komp.Nr. CL9/XM9	AA NAA	0 265 230 408 ^T 0 265 230 406 ^T	
	115 CDI	10.03-07.10	110	Fg.-Nr. →195055 Fg.-Nr. →3555131 Fg.-Nr. 195056 →	NAA AA NAA	0 265 225 347 ^T 0 265 230 408 ^T 0 265 230 406 ^T	
	119	10.03-12.10	140	Fg.-Nr. →195055 Fg.-Nr. 195056 →3555131		0 265 225 347 ^T 0 265 230 406 ^T	
	120 CDI	04.06-07.10	150	Fg.-Nr. →3555131		0 265 230 406 ^T	
	122	10.03-12.10	160	Fg.-Nr. →195055 Fg.-Nr. 195056 →		0 265 225 347 ^T 0 265 230 406 ^T	
	123	06.04-08.07	170			0 265 235 168 ^T	
126	09.07 →	190		TW	0 265 230 406 ^T		

	109 CDI	10.03-10.06	65	Fg.-Nr. →195055 Fg.-Nr. 195056 →		0 265 005 258 0 265 005 628	
		11.06-07.10	70			0 265 005 774	
	110 CDI	07.10 →	70			0 265 005 774	
	111 CDI	10.03-07.10	80	Fg.-Nr. →195055 Fg.-Nr. 195056 →		0 265 005 258 0 265 005 628	
		11.06-07.10	85			0 265 005 774	
	113 CDI	07.10 →	100			0 265 005 774	
	115 CDI	10.03-07.10	110	Fg.-Nr. →195055 Fg.-Nr. 195056 →		0 265 005 258 0 265 005 774	
	116 CDI	07.10 →	120			0 265 005 774	
	119	10.03-12.10	140	Fg.-Nr. →195055 Fg.-Nr. 195056 →		0 265 005 258 0 265 005 774	
	120 CDI	04.06-07.10	150	Fg.-Nr. →195055 Fg.-Nr. 195056 →		0 265 005 258 0 265 005 774	
122	10.03-12.10	160	Fg.-Nr. →195055 Fg.-Nr. 195056 →		0 265 005 258 0 265 005 774		
122 CDI	07.10 →	165			0 265 005 774		
123	06.04-08.07	170	Fg.-Nr. →195055 Fg.-Nr. 195056 →		0 265 005 258 0 265 005 628		
126	09.07 →	190			0 265 005 774		

	109 CDI	10.03-07.10	65/70			0 265 005 429	
	110 CDI	07.10 →	70		TW	0 265 005 429	
	111 CDI	10.03-07.10	80			0 265 005 429	
		11.06-07.10	85		TW	0 265 005 429	
	113 CDI	07.10 →	100		TW	0 265 005 429	
	115 CDI	10.03-07.10	110		TW	0 265 005 429	
	116 CDI	07.10 →	120		TW	0 265 005 429	
	119	10.03-12.10	140	Fg.-Nr. →478092		0 265 005 429	
	120 CDI	04.06-07.10	150		TW	0 265 005 429	
	122	10.03-12.10	160			0 265 005 429	
122 CDI	07.10 →	165		TW	0 265 005 429		
123	06.04-08.07	170			0 265 005 429		
126	09.07 →	190		TW	0 265 005 429		

2t [T1]

	208 D	10.88-06.95	58-60	Fg.-Nr. →649390, →614796 Fg.-Nr. 649391 →, 614797 →, P000001 →	JBH JBH	ATE ATE	0 986 480 059 0 986 480 062	23,81 25,4
		ABS	10.88-06.95	58-60		JBH,SA	0 986 480 915	25











		S								
◀ MERCEDES-BENZ 2t [T1]										
	210, D	08.82-06.95	70-77	Fg.-Nr. →649390, →614796	JBH	ATE	0 986 480 059	23,81		
				Fg.-Nr. 649391→, 614797→, P000001→	JBH	ATE	0 986 480 062	25,4		
				ABS	01.88-06.95	70-77		JBH,SA		0 986 480 915
	208 D	10.88-06.95	58-60	Fg.-Nr. 231605→499999	RLE		0 986 486 056	19,05		
				Fg.-Nr. 232363→499999	LLE		0 986 486 056	19,05		
				Fg.-Nr. 547855→			0 986 486 056	19,05		
	210	08.82-06.95	70-77	Fg.-Nr. 231605→499999	RLE		0 986 486 056	19,05		
				Fg.-Nr. 232363→499999	LLE		0 986 486 056	19,05		
				Fg.-Nr. 547855→			0 986 486 056	19,05		
210 D	10.88-06.95	70-72				0 986 486 056	19,05			
	208 D	10.88-06.95	58-60				0 986 486 547	23,81		
	210	08.82-06.95	70-77				0 986 486 547	23,81		
	208 D	10.88-06.95	58-60				0 265 105 022 ^H			
	210, D	01.88-06.95	70-77				0 265 105 022 ^H			
3t [T1]										
	308 D	10.88-06.95	58-60	Fg.-Nr. →625656	BUS,JBH	ATE	0 986 480 059	23,81		
				Fg.-Nr. →649390, →614796	JBH	ATE	0 986 480 059	23,81		
				Fg.-Nr. 625657→	BUS,JBH	ATE	0 986 480 062	25,4		
				Fg.-Nr. 649391→, 614797→, P000001→	JBH	ATE	0 986 480 062	25,4		
	ABS	10.88-06.95	58-60				JBH,SA		0 986 480 915	25
	310	08.82-06.95	70-77	Fg.-Nr. →625656	BUS,JBH	ATE	0 986 480 059	23,81		
				Fg.-Nr. →649390, →614796	JBH	ATE	0 986 480 059	23,81		
				Fg.-Nr. 625657→	BUS,JBH	ATE	0 986 480 062	25,4		
				Fg.-Nr. 649391→, 614797→, P000001→	JBH	ATE	0 986 480 062	25,4		
	310, D	ABS	01.88-06.95	70-77				JBH,SA		0 986 480 915
310 D	10.88-06.95	70-72	Fg.-Nr. →649390, →614796	JBH	ATE	0 986 480 059	23,81			
			Fg.-Nr. 649391→, 614797→, P000001→	JBH	ATE	0 986 480 062	25,4			
	308 D	10.88-06.95	58-60				G10	0 986 486 021	19,05	
							G12	0 986 486 056	19,05	
	310	08.82-06.95	70-77				G10	0 986 486 021	19,05	
							G12	0 986 486 056	19,05	
	308 D	10.88-06.95	58-60				0 986 486 547	23,81		
	310, D	08.82-06.95	70-77				0 986 486 547	23,81		
	308 D	10.88-06.95	58-60				0 265 105 022 ^H			
	310	08.82-06.95	70-77			EFV	0 265 105 022 ^H			
		01.88-06.95	70-77				0 265 105 022 ^H			
	310 D	10.88-06.95	70-72				0 265 105 022 ^H			
4t [T1]										
	408 D	11.88-06.95	58-60	Fg.-Nr. →598434	JBH		0 986 480 060	25,4		
				Fg.-Nr. 598435→	JBH		0 986 480 917	26,99		
	410	08.82-06.95	70-77	Fg.-Nr. →598434	JBH		0 986 480 060	25,4		
				Fg.-Nr. 598435→	JBH		0 986 480 917	26,99		
	408 D	11.88-06.95	58-60				G10	0 986 486 021	19,05	
							G12	0 986 486 056	19,05	
	410	08.82-06.95	70-77				G10	0 986 486 021	19,05	
							G12	0 986 486 056	19,05	

		S							
	408 D	11.88-06.95	58-60				0 986 486 547	23,81	
	410, D	08.82-06.95	70-77				0 986 486 547	23,81	
	408 D	11.88-06.95	58-60			EFV	0 265 105 022 ^H		
	410, D	01.88-06.95	70-77			EFV	0 265 105 022 ^H		
311 Sprinter [909]									
	CDI	11.13→	80				0 986 486 053	19,05	
411 Sprinter [909]									
	CDI	11.13→	80				0 986 486 053	19,05	
MG									
MG TF									
	115 1.6i	03.02-05.05	85	Fg.-Nr. →XD 511058			0 265 215 005 ^H		
	120 1.8i	03.02-05.05	88	Fg.-Nr. →XD 511058			0 265 215 005 ^H		
	135 1.8i	03.02→	100	Fg.-Nr. →XD 511058			0 265 215 005 ^H		
	160 1.8i	03.02-05.05	118	Fg.-Nr. →XD 511058			0 265 215 005 ^H		
	115 1.6i	03.02-05.05	85	Fg.-Nr. →XD 511058			1 267 000 827 ^H		
	120 1.8i	03.02-05.05	88	Fg.-Nr. →XD 511058			1 267 000 827 ^H		
	135 1.8i	03.02→	100	Fg.-Nr. →XD 511058			1 267 000 827 ^H		
	160 1.8i	03.02-05.05	118	Fg.-Nr. →XD 511058			1 267 000 827 ^H		
MGF									
	1.6 i 16V	ABO 10.01-03.02	82	Fg.-Nr. →AD 000505			0 986 480 956	23,8	
	1.8 i 16V, 16V Trophy	ABO 10.95-03.02	88/107/118	Fg.-Nr. →AD 000505			0 986 480 956	23,8	
	1.6 i 16V	10.01-03.02	82	Fg.-Nr. →XD 511058			0 265 215 005 ^H		
	1.8 i 16V, 16V Trophy	10.95-03.02	88/107/118	Fg.-Nr. →XD 511058			0 265 215 005 ^H		
	1.6 i 16V	10.01-03.02	82	Fg.-Nr. →XD 511058			1 267 000 827 ^H		
	1.8 i 16V, 16V Trophy	10.95-03.02	88/107/118	Fg.-Nr. →XD 511058			1 267 000 827 ^H		
ZR									
	2.0 D Turbo	10.01-05.05	74/82	Fg.-Nr. →WD 267263			0 265 216 043 ^B		
				Fg.-Nr. WD 267264→YD 471564			0 265 216 520 ^B		
				Fg.-Nr. YD 471565→			0 265 216 685 ^B		
	105 1.4i 16V	10.01-05.05	76	Fg.-Nr. →WD 267263			0 265 216 043 ^B		
				Fg.-Nr. WD 267264→YD 471564			0 265 216 520 ^B		
				Fg.-Nr. YD 471565→			0 265 216 685 ^B		
	120 1.8i 16V	10.01-05.05	86	Fg.-Nr. →WD 267263			0 265 216 043 ^B		
				Fg.-Nr. WD 267264→YD 471564			0 265 216 520 ^B		
				Fg.-Nr. YD 471565→			0 265 216 685 ^B		
	160 1.8i 16V	10.01-05.05	118	Fg.-Nr. →WD 267263			0 265 216 043 ^B		
				Fg.-Nr. WD 267264→YD 471564			0 265 216 520 ^B		
				Fg.-Nr. YD 471565→			0 265 216 685 ^B		



◀ MG ZR									
	2.0 D Turbo	10.01-05.05	74/82	Fg.-Nr. →WD 267263		1 267 000 826 ^H			
	105 1.4i 16V	10.01-05.05	76	Fg.-Nr. →WD 267263		1 267 000 826 ^H			
	120 1.8i 16V	10.01-05.05	86	Fg.-Nr. →WD 267263		1 267 000 826 ^H			
	160 1.8i 16V	10.01-05.05	118	Fg.-Nr. →WD 267263		1 267 000 826 ^H			
ZS									
	2.0 TD	10.01-05.05	74	Fg.-Nr. AD 074465→ YD 471063		JBH	0 986 480 889	23,8	
	110 1.6i 16V	03.05-05.05	80	Fg.-Nr. →AD 074464		JBH	0 986 481 027	23,81	
				Fg.-Nr. AD 074465→		JBH	0 986 480 889	23,8	
	120 1.8i 16V	10.01-05.05	86	Fg.-Nr. AD 074465→ YD 471063		JBH	0 986 480 889	23,8	
	180 2.5i 24V	10.01-05.05	130	Fg.-Nr. AD 074465→ YD 471063		JBH	0 986 480 889	23,8	
	2.0 TD	10.01-05.05	74	Fg.-Nr. AD 074465→YD 471063			0 986 485 134		
	110 1.6i 16V	03.05-05.05	80	Fg.-Nr. AD 074465→			0 986 485 134		
	120 1.8i 16V	10.01-05.05	86	Fg.-Nr. AD 074465→YD 471063			0 986 485 134		
	180 2.5i 24V	10.01-05.05	130	Fg.-Nr. AD 074465→YD 471063			0 986 485 134		
	2.0 TD	10.01-05.05	74	Fg.-Nr. →AD 250028			0 265 216 043 ^B		
				Fg.-Nr. →YD 471063			0 265 216 520 ^B		
				Fg.-Nr. YD 471064→			0 265 216 685 ^B		
	110 1.6i 16V	03.05-05.05	80	Fg.-Nr. →AD 250028		AG	0 265 216 047 ^B		
						GS	0 265 216 043 ^B		
				Fg.-Nr. WD 250029→		AG	0 265 216 494 ^B		
				Fg.-Nr. WD 250029→ YD 471063		GS	0 265 216 520 ^B		
				Fg.-Nr. YD 471064→			0 265 216 685 ^B		
	120 1.8i 16V	10.01-05.05	86	Fg.-Nr. →AD 250028			0 265 216 043 ^B		
				Fg.-Nr. →YD 471063			0 265 216 520 ^B		
			Fg.-Nr. YD 471064→			0 265 216 685 ^B			
	180 2.5i 24V	10.01-05.05	130	Fg.-Nr. →AD 250028			0 265 216 043 ^B		
				Fg.-Nr. →YD 471063			0 265 216 520 ^B		
				Fg.-Nr. YD 471064→			0 265 216 685 ^B		
							0 265 216 685 ^B		
	2.0 TD	10.01-05.05	74	Fg.-Nr. →AD 250028			1 267 000 826 ^H		
	110 1.6i 16V	03.05-05.05	80	Fg.-Nr. WD 250029→ YD 471063		GS	1 273 004 247 ^H		
				Fg.-Nr. YD 471064→			1 273 004 397 ^H		
	120 1.8i 16V	10.01-05.05	86	Fg.-Nr. →AD 250028			1 267 000 826 ^H		
180 2.5i 24V	10.01-05.05	130	Fg.-Nr. →AD 250028			1 267 000 826 ^H			
ZT									
	135 2.0 CDTi	10.02-05.05	96				0 265 224 010 ^F		
	160 2.5i 24V	10.01-05.05	118				0 265 224 005 ^F		
	190 2.0 CDT	10.01-05.05	85				0 265 224 010 ^F		
	190 2.5i 24V	10.01-05.05	140				0 265 224 005 ^F		
	260 4.6i Power	03.02-05.05	191				0 265 223 006 ^F		
	160 2.5i 24V	10.01-05.05	118				0 265 108 045 ^H		
	190 2.5i 24V	10.01-05.05	140				0 265 108 045 ^H		
ZT-Tourer									
	135 2.0 CDTi	10.02-05.05	96				0 265 224 010 ^F		
	160 2.5i 24V	10.01-05.05	118				0 265 224 005 ^F		





		S							
									

190 2.0 CDT	10.01-05.05	85				0 265 224 010 ^F
190 2.5i 24V	10.01-05.05	140				0 265 224 005 ^F
260 4.6i Power	03.03-05.05	191				0 265 223 006 ^F

160 2.5i 24V	10.01-05.05	118				0 265 108 045 ^H
190 2.5i 24V	10.01-05.05	140				0 265 108 045 ^H

MINI (BMW)**Cooper Cabrio [R 52]**

	1.6	MFD 07.04-07.08	85/120-125		JBH	0 986 481 042	22,2
	1.6 S	OFD 07.04-07.08	85/120-125		JBH	0 986 481 045	22,2

	1.6 S	08.04-07.08	120-125			0 986 486 582	23,81
--	--------------	-------------	---------	--	--	----------------------	-------

Cooper Cabrio [R 57]

	1.6, D, S	03.09→	82/85-90/128/135/147			0 986 481 060	23,8
	2.0 D, SD	03.11→	82/105			0 986 481 060	23,8

Cooper Cabrio [R 58]

	1.6	09.11→	85-90			0 986 481 060	23,8
--	------------	--------	-------	--	--	----------------------	------

Cooper Clubman [R 55]

	1.6, D, S	11.07-06.14	80/82/85-90/120-128/135/147			0 986 481 060	23,8
	2.0 D, SD	03.11-06.14	82/100-105			0 986 481 060	23,8

Cooper Clubvan [R 55]

	1.6, D	02.13-06.14	82/90			0 986 481 060	23,8
	2.0 D	02.13-06.14	82			0 986 481 060	23,8

Cooper Countryman [R 60]

	1.6, ALL4, D, D ALL4, S, S ALL4	09.10→	82/85-90/120/135/140/147			0 986 481 060	23,8
	2.0 D, D ALL4, SD, SD ALL4	03.11→	82/100-105			0 986 481 060	23,8

Cooper Coupé [R 58]

	1.6 S	09.11→	120/135/147			0 986 481 060	23,8
	2.0 SD	09.11→	100-105			0 986 481 060	23,8



























Cooper [F 55]

	1.5	10.14→	85/100			0 204 817 536	22,2
	1.5 D						



		S							
◀ MINI									
Cooper [F 56]									
	1.5, D	03.14→	85/100				0 204 817 536	22,2	
	2.0 S, SD	03.14→	125/141				0 204 817 536	22,2	
Cooper One Cabrio [R 52]									
	1.6	MFD 07.04-07.08	66		JBH		0 986 481 042	22,2	
		OFD 07.04-07.08	66		JBH		0 986 481 045	22,2	
Cooper One Cabrio [R 57]									
	1.6	03.10→	72				0 986 481 060	23,8	
Cooper One Clubman [R 55]									
	1.4	03.09-02.10	70				0 986 481 060	23,8	
	1.6, D	03.10-06.14	66/72				0 986 481 060	23,8	
Cooper One Countryman [R 60]									
	1.6	09.10→	66/72				0 986 481 060	23,8	
	1.6 D								
Cooper One [F 55]									
	1.2	11.14→	55/75				0 204 817 536	22,2	
	1.5	11.14→	70				0 204 817 536	22,2	
Cooper One [F 56]									
	1.2	04.14→	55/75				0 204 817 536	22,2	
	1.5 D	03.14→	70				0 204 817 536	22,2	
Cooper One [R 50]									
	1.4 D	MFD 09.02-11.06	55/65		JBH		0 986 481 042	22,2	
	1.4 i	OFD 09.02-11.06	55/65		JBH		0 986 481 045	22,2	
	1.6	MFD 06.01-11.06	66		JBH		0 986 481 042	22,2	
		OFD 06.01-11.06	66		JBH		0 986 481 045	22,2	
	1.4 D	03.03-09.05	55				0 986 486 582	23,81	
		09.05-11.06	65				0 986 486 582	23,81	
	1.4 i	09.02-07.04	55				0 986 486 582	23,81	
	1.6	06.01-07.04	66				0 986 486 582	23,81	
Cooper One [R 56]									
	1.4	03.07-02.10	55/70				0 986 481 060	23,8	
	1.6, D	09.09-11.13	55/66/72				0 986 481 060	23,8	



		S							
Cooper Paceman [R 61]									
									
	1.6, ALL4, D, D ALL4, S, S ALL4	03.13→	82/85-90/135/140				0 986 481 060	23,8	
	2.0D, D ALL4, SD, SD ALL4	03.13→	82/100-105				0 986 481 060	23,8	
Cooper [R 50]									
									
	1.6	MFD 06.01-11.07	85		JBH		0 986 481 042	22,2	
		OFD 06.01-11.07	85		JBH		0 986 481 045	22,2	
	1.6	06.01-07.04	85				0 986 486 582	23,81	
Cooper [R 56]									
									
	1.6, D, S	11.06-11.13	80/82/85-90/120/128/135/147				0 986 481 060	23,8	
	2.0D, SD	03.11-11.13	82/100-105				0 986 481 060	23,8	
Cooper Roadster [R 59]									
									
	1.6, S	02.12→	85-90/120/135/147				0 986 481 060	23,8	
	2.0SD	02.12→	100-105				0 986 481 060	23,8	
Cooper S [F 55]									
									
	2.0	10.14→	125/141				0 204 817 536	22,2	
	2.0D								
Cooper S [R 53]									
									
	1.6	MFD 03.02-11.06	120/125		JBH		0 986 481 042	22,2	
		OFD 03.02-11.06	120/125		JBH		0 986 481 045	22,2	
	1.6	03.02-11.06	120/125				0 986 486 582	23,81	
John Cooper Works Cabrio [R 52]									
									
	1.6	MFD 08.04-07.08	154		JBH		0 986 481 042	22,2	
		OFD 08.04-07.08	154		JBH		0 986 481 045	22,2	
	1.6	08.04-07.08	154				0 986 486 582	23,81	
John Cooper Works Cabrio [R 57]									
									
	1.6	03.09→	155				0 986 481 060	23,8	





◀ MINI

John Cooper Works Clubman [R 55]



	1.6	07.08-06.14	155		0986 481 060	23,8
--	-----	-------------	-----	--	--------------	------

John Cooper Works Countryman [R 60]



	1.6 All4	11.12→	160		0986 481 060	23,8
--	----------	--------	-----	--	--------------	------

John Cooper Works Coupé [R 58]



	1.6	09.11→	155		0986 481 060	23,8
--	-----	--------	-----	--	--------------	------

John Cooper Works Paceman [R 61]



	1.6 ALL4	03.13→	160		0986 481 060	23,8
--	----------	--------	-----	--	--------------	------

John Cooper Works [R 53]



	1.6	MFD 10.03-11.06	147/154-160	JBH	0986 481 042	22,2
		OFD 10.03-11.06	147/154-160	JBH	0986 481 045	22,2

	1.6	10.03-11.06	147/154-160		0986 486 582	23,81
--	-----	-------------	-------------	--	--------------	-------

John Cooper Works [R 56]



	1.6	07.08-11.13	155		0986 481 060	23,8
--	-----	-------------	-----	--	--------------	------

John Cooper Works Roadster [R 59]



	1.6	02.12→	155		0986 481 060	23,8
--	-----	--------	-----	--	--------------	------

MITSUBISHI

Canter 35 [FB]

















	2.5D	01.86-09.96	51		F 026 A01 632	
--	------	-------------	----	--	---------------	--

Carisma [DA]























	1.3 i 16V	07.01-12.03	60		0 204 123 335	23,81
		03.99-12.03	73-76		0 204 123 335	23,81
		ABO 05.96-02.99	66/73		0 204 123 200	22,22



		S							
1.6 i 16V		ABS	05.96-02.99	66/73			0 204 123 335	23,81	
1.8 GDI			03.99-12.03	92		TKO	0 204 123 335	23,81	
						TKO	0 204 055 179		
		ABS	05.97-02.99	92			0 204 123 335	23,81	
1.8 GDI, i 16V		ABO	05.96-02.99	85/92/103			0 204 123 200	22,22	
1.8 i 16V		ABS	05.96-04.97	103			0 204 123 335	23,81	
			05.96-02.99	85			0 204 123 335	23,81	
1.9 D Turbo		ABO	05.96-06.00	66			0 204 123 200	22,22	
		ABS	05.96-06.00	66			0 204 123 335	23,81	
1.9 Di-D			07.00-12.03	75/85			0 204 123 335	23,81	
 1.3 i 16V			07.01-12.03	60		LLE	0 204 021 966		
						RLE	0 204 021 967		
1.6 i 16V			05.96-12.03	66/73-76		LLE	0 204 021 966		
						RLE	0 204 021 967		
1.8 GDI		ABO	05.97-12.03	92		LLE	0 204 021 968		
						RLE	0 204 021 969		
		ABS	05.97-12.03	92		LLE	0 204 021 970		
						RLE	0 204 021 971		
1.8 i 16V			05.96-04.97	103			0 204 021 965		
		ABO	05.96-02.99	85		RLE	0 204 125 481		
		ABS	05.96-02.99	85		LLE	0 204 021 966		
						RLE	0 204 021 967		
1.9 D Turbo		ABO	05.96-02.99	66		RLE	0 204 125 481		
		ABS	05.96-06.00	66		LLE	0 204 021 965		
						RLE	0 204 021 967		
1.9 Di-D			07.00-12.03	75/85		LLE	0 204 021 965		
						RLE	0 204 021 967		
 1.3 i 16V			07.01-12.03	60			F 026 A01 905		
1.6 i 16V			06.96-12.03	66/73-76			F 026 A01 905		
1.8 GDI, i 16V			06.96-12.03	85/92/103			F 026 A01 905		
1.9 D Turbo			06.96-06.00	66			F 026 A01 905		
 1.8 GDI			03.99-10.01	92			F 026 A06 047		
			11.01-12.03	92			F 026 A06 056		
 1.3 i 16V			07.01-12.03	60			0 265 216 774^B		
1.6 i 16V			05.96-04.97	66			0 265 216 046^H		
			05.97-02.99	66			0 265 216 465^H		
				73			0 265 216 465^H		
			03.99-06.00	73-76			0 265 216 465^H		
			07.00-12.03	73-76			0 265 216 774^B		
1.8 GDI			05.97-06.00	92			0 265 216 465^H		
			07.00-12.03	92			0 265 216 774^B		
1.8 i 16V			05.96-04.97	85			0 265 216 046^H		
				103			0 265 216 046^H		
			05.97-02.99	85			0 265 216 465^H		
1.9 D Turbo			05.96-04.97	66			0 265 216 046^H		
			05.97-06.00	66			0 265 216 465^H		
1.9 Di-D			07.00-12.03	75/85			0 265 216 774^B		
Carisma Hatchback [DA]									
									
 1.6 i 16V			03.99-12.03	73-76			0 204 123 335	23,81	
		ABO	05.95-02.99	66/73			0 204 123 200	22,22	
		ABS	05.95-02.99	66/73			0 204 123 335	23,81	
1.8 GDI			03.99-12.03	92		TKO	0 204 123 335	23,81	
						TKO	0 204 055 179		
		ABS	05.97-02.99	92			0 204 123 335	23,81	
1.8 GDI, i 16V		ABO	05.95-02.99	85/92			0 204 123 200	22,22	





















		S								
◀ MITSUBISHI Carisma Hatchback [DA]										
	1.8 i 16V		05.95-04.96	103			0 204 123 335	23,81		
			05.96-04.97	103			0 204 123 200	22,22		
		ABS	05.95-02.99	85			0 204 123 335	23,81		
	1.9 D Turbo	ABO	05.96-06.00	66			0 204 123 200	22,22		
		ABS	05.96-06.00	66			0 204 123 335	23,81		
1.9 DI-D		07.00-12.03	75/85			0 204 123 335	23,81			
	1.6 i 16V		05.95-12.03	66/73-76		LLE	0 204 021 966			
						RLE	0 204 021 967			
	1.8 GDI	ABO	05.97-12.03	92			LLE	0 204 021 968		
							RLE	0 204 021 969		
		ABS	05.97-12.03	92			LLE	0 204 021 970		
							RLE	0 204 021 971		
	1.8 i 16V		05.95-04.97	103				0 204 021 965		
		ABO	05.95-02.99	85			RLE	0 204 125 481		
		ABS	05.95-02.99	85			LLE	0 204 021 966		
							RLE	0 204 021 967		
	1.9 D Turbo	ABO	05.96-02.99	66			RLE	0 204 125 481		
		ABS	05.96-06.00	66			LLE	0 204 021 965		
							RLE	0 204 021 967		
	1.9 DI-D		07.00-12.03	75/85			LLE	0 204 021 965		
							RLE	0 204 021 967		
	1.6 i 16V		06.96-12.03	66/73-76			F 026 A01 905			
	1.8 GDI, i 16V		06.96-12.03	85/92/103			F 026 A01 905			
	1.9 D Turbo		06.96-06.00	66			F 026 A01 905			
	1.8 GDI		03.99-10.01	92			F 026 A06 047			
			11.01-12.03	92			F 026 A06 056			
	1.6 i 16V		05.95-04.97	66			0 265 216 046 ^H			
			05.97-02.99	66			0 265 216 465 ^H			
				73			0 265 216 465 ^H			
			03.99-06.00	73-76			0 265 216 465 ^H			
			07.00-12.03	73-76			0 265 216 774 ^B			
	1.8 GDI		05.97-06.00	92			0 265 216 465 ^H			
			07.00-12.03	92			0 265 216 774 ^B			
	1.8 i 16V		05.95-04.97	85			0 265 216 046 ^H			
				103			0 265 216 046 ^H			
			05.97-02.99	85			0 265 216 465 ^H			
	1.9 D Turbo		05.96-04.97	66			0 265 216 046 ^H			
			05.97-06.00	66			0 265 216 465 ^H			
	1.9 DI-D		07.00-12.03	75/85			0 265 216 774 ^B			
	Colt Cabrio [CZ]									
	1.5		03.06-06.07	80/110			0 265 005 687			
	1.5 Turbo									
Colt [CA/CC]										
	1.3 i 12V	ABO	12.91-11.95	55		LLE	0 986 480 662	20,6		
		ABS	12.91-11.95	55			F 01G 09C 0TA			
	1.6 i, i 16V 2WD	ABO	12.91-12.96	66/83			0 986 480 662	20,6		
	1.6 i, i 16V 2WD, i 16V 4WD	ABS	12.91-12.96	66/83			F 01G 09C 0TA			
1.8 i	ABS	12.91-11.95	103			F 01G 09C 0TA				
	1.3 i 12V	ABO	12.91-11.95	55		RLE	F 01G 09B 0XZ			
	1.6 i, i 16V 2WD		12.91-12.96	66/83		RLE	F 01G 09B 0XZ			
	1.6 i 16V 4WD	ABO	12.91-11.95	83		LLE	F 01G 09B 101			

		S							
1.8i		ABO	12.91-11.95	103		LLE	F 01G 09B 101		
		ABS	12.91-11.95	103		RLE	F 01G 09B 151		
 1.3i 12V			12.91-11.95	55			F 026 A01 877		
1.6i, i 16V 2WD, i 16V 4WD			12.91-12.96	66/83		RLE	F 026 A01 877		
1.8i			12.91-11.95	103		RLE	F 026 A01 877		
 1.6i, i 16V 2WD, i 16V 4WD			12.91-12.96	66/83			F 026 A02 565		
1.8i			12.91-11.95	103			F 026 A02 565		
 1.6i 16V 4WD			12.91-11.95	83			F 01G 09D 00F^H		
Colt [CJ]									
									
 1.3i 12V, i 16V		ABS	11.95-06.03	55/60					F 01G 09C 11J⁶
1.6i 16V		ABS	11.95-06.03	66/76					F 01G 09C 11J⁶
 1.3i 12V, i 16V			11.95-06.03	55/60			F 026 A01 905		
1.5			11.95-05.00	69			F 026 A01 905		
1.6i 16V			11.95-06.03	66/76			F 026 A01 905		
 1.3i 12V			11.95-05.00	55			F 026 A06 047		
1.3i 16V			06.00-10.01	60			F 026 A06 047		
			11.01-06.03	60			F 026 A06 056		
1.5			11.95-05.00	69			F 026 A06 047		
1.6i 16V			11.95-05.00	66			F 026 A06 047		
			06.00-06.03	76			F 026 A06 056		
 1.3i 12V, i 16V			11.95-06.03	55/60			F 01G 09D 04A^H		
1.6i 16V			11.95-06.03	66/76			F 01G 09D 04A^H		
Colt [CZ]									
									
 1.1			08.04-12.04	55			0 265 234 257^T		
			01.05-09.05	55			0 265 234 316^T		
1.3			04.04-04.04	70			0 265 231 530^B		
			04.04-12.04	70			0 265 234 257^T		
			01.05-09.05	70			0 265 234 316^T		
1.5			04.04-04.04	80			0 265 231 530^B		
			04.04-12.04	80			0 265 234 257^T		
			01.05-09.05	80			0 265 234 316^T		
1.5 DI-D			08.04-12.04	70			0 265 234 257^T		
			01.05-09.05	50			0 265 234 316^T		
				70			0 265 234 316^T		
1.5 Turbo			01.05-09.05	110			0 265 234 500^T		
 1.1			08.04-01.07	55			0 265 005 687		
1.3			04.04-01.07	70			0 265 005 687		
1.5, Turbo			04.04-01.07	80/110			0 265 005 687		
1.5 DI-D			08.04-04.07	50/70			0 265 005 687		
 1.1			07.05-12.12	55			0 265 005 504		
1.3			07.05-04.13	70			0 265 005 504		
1.5, DI-D, Turbo			07.05-04.13	50/70/80/110			0 265 005 504		



		S							
◀ MITSUBISHI									
Eclipse [D2/3]									
	1.8 i							0 986 480 730	22,2
	2.0 i 16V	ABO	01.90-03.94	110				0 986 480 842	25,4
		ABS	01.90-03.94	110				0 986 480 737	25,4
	2.0 i 16V Turbo		08.90-03.94	147				0 986 480 730	22,2
	2.0 i 16V 4WD		04.91-03.94	110				0 986 480 737	25,4
	2.0 i 16V		08.95-04.99	104				F 026 A02 565	
	2.0 i 16V 4WD		04.91-03.94	110				0 265 102 001 ^H	
Express [SH]									
	2.0 4x4		01.92-08.94	66	STB			F 026 A01 681	
	2.4 4x4		09.91-09.94	81	STB			F 026 A01 680	
	2.5 D 4x4		01.92-08.94	55	STB			F 026 A01 680	
Express [SJ]									
	2.0 4x4		10.95-06.96	78	STB			F 026 A01 681	
Express [WA]									
	2.4	ABO	09.94-12.00	97				F 026 A01 766	
			09.94-01.02	97	GS			F 026 A01 767	
Galant									
	2.0 i		01.97-10.02	100				F 01G 09C 10S	
			11.02-12.03	100				F 01G 09C 0UR	F 01G 09C 1LK ⁶
	2.0 i		01.97-10.02	100				F 01G 09B 106	
			11.02-12.03	100				F 01G 09B 15D	
Galant [EA]									
	2.0 D Turbo	ABO	10.96-05.03	66/100	LLE			F 01G 09C 10S	F 01G 09C 1LW ⁶
	2.0 i 16V				RLE			F 01G 09C 10T	F 01G 09C 1LW ⁶
		ABS	10.96-05.03	66/100	LLE			F 01G 09C 0UR	F 01G 09C 1LK ⁶
					RLE			F 01G 09C 0UN	F 01G 09C 1LK ⁶
	2.4 GDI		12.98-05.03	110	LLE			F 01G 09C 0UR	F 01G 09C 1LK ⁶
					RLE			F 01G 09C 0UN	F 01G 09C 1LK ⁶
	2.5 i V6-24		10.96-05.03	118	LLE,TKO			F 01G 09C 0UR	F 01G 09C 1LK ⁶
					LLE,TKO			F 01G 09C 0UR	F 01G 09C 1LN ⁶
					RLE			F 01G 09C 0UN	F 01G 09C 1LK ⁶
	2.0 D Turbo	ABO	10.96-02.00	66	RLE			F 01G 09B 105	
	2.0 i 16V	ABO	10.96-05.03	100	LLE			F 01G 09B 106	
					RLE			F 01G 09B 104	
		ABS	10.96-05.03	100	LLE			F 01G 09B 15D	
					RLE			F 01G 09B 15C	





























		S							
2.4 GDI		01.99-05.03	110			LLE	F 01G 09B 184		
						RLE	F 01G 09B 183		
2.5 iV6-24		10.96-05.03	118			LLE,TKO	F 01G 09B 15D		
						RLE	F 01G 09B 15C		
 2.0 D Turbo		10.96-02.00	66				F 026 A06 047		
2.0 i 16V		10.96-10.01	100				F 026 A06 047		
		11.01-05.03	100				F 026 A06 056		
2.4 GDI		12.98-10.01	110				F 026 A06 047		
		11.01-05.03	110				F 026 A06 056		
2.5 iV6-24		10.96-10.01	118				F 026 A06 047		
		11.01-05.03	118				F 026 A06 056		
Galant [E5...8]									
									
 1.8 i 16V	ABO	11.92-05.96	85-93			LLE	0 986 480 730	22,2	
2.0 D Turbo	ABO	11.92-10.96	66-69			LLE	0 986 480 730	22,2	
	ABS	12.94-10.96	66-69			RLE	F 026 A01 695		
2.0 iV6-24	ABS	12.94-05.96	110			RLE	F 026 A01 695		
2.0 i 16V	ABS	12.94-05.96	101			RLE	F 026 A01 695		
2.0 i 16V 4WD	ABS	11.92-11.94	101			LLE	0 986 480 737	25,4	
2.5 iV6-24		11.92-05.96	125			RLE	F 026 A01 695		
 1.8 i 16V	ABO	11.92-05.96	85-93			LLE	F 01G 09B 103		
	ABS	11.92-05.96	85-93			RLE	F 01G 061 0P3		
2.0 D Turbo	ABO	11.92-10.96	66-69			LLE	F 01G 09B 0Y3		
	ABS	11.92-10.96	66-69			RLE	F 01G 09B 15B		
2.0 iV6-24	ABS	11.92-05.96	110			RLE	F 01G 061 0P3		
2.0 iV6-24, iV6-24 4WS, i 16V	ABO	11.92-05.96	101/110			LLE	F 01G 09B 103		
2.0 i 16V	ABS	11.92-05.96	101			RLE	F 01G 061 0P3		
2.0 i 16V 4WD		11.92-05.96	101			RLE	F 01G 061 0P3		
 1.8 i 16V		11.92-05.96	85-93			RLE	0 986 AB8 917	15,88	
2.0 iV6-24		11.92-05.96	110				0 986 AB8 917	15,88	
2.0 iV6-24 4WS		11.92-04.95	110			RLE	0 986 AB8 917	15,88	
2.0 i 16V		11.92-05.96	101			RLE	0 986 AB8 917	15,88	
2.0 i 16V 4WD									
 1.8 i 16V		11.92-05.96	85-93				F 026 A02 565		
2.0 D Turbo, i 16V, i 16V 4WD		11.92-10.96	66-69/101				F 026 A02 565		
 2.5 iV6-24		11.92-05.96	125			RLE	F 01G 09D 00H ^H		
 2.0 i 16V 4WD		11.92-05.96	101				F 01G 09E 012 ^H		
2.5 iV6-24		11.92-05.96	125				F 01G 09E 012 ^H		
Galant Hatchback [E5...8]									
									
 1.8 i 16V	ABO	11.92-05.96	93			LLE	0 986 480 730	22,2	
2.0 D Turbo	ABO	11.92-10.96	66-69			LLE	0 986 480 730	22,2	
	ABS	12.94-10.96	66-69			RLE	F 026 A01 695		
2.0 iV6-24	ABS	12.94-05.96	110			RLE	F 026 A01 695		
2.0 i 16V	ABS	12.94-05.96	101			RLE	F 026 A01 695		
2.0 i 16V 4WD	ABS	11.92-11.94	101			LLE	0 986 480 737	25,4	
2.5 iV6-24		11.92-05.96	125			RLE	F 026 A01 695		
 1.8 i 16V	ABO	11.92-05.96	93			LLE	F 01G 09B 103		
	ABS	11.92-05.96	93			RLE	F 01G 061 0P3		



		S							
◀ MITSUBISHI Galant Hatchback [E5...8]									
	2.0 D Turbo	ABO	11.92-10.96	66-69		LLE	F 01G 09B 0Y3		
		ABS	11.92-10.96	66-69		RLE	F 01G 09B 15B		
	2.0 iV6-24	ABS	11.92-05.96	110		RLE	F 01G 061 0P3		
		ABO	11.92-05.96	101/110		LLE	F 01G 09B 103		
	2.0 i16V	ABS	11.92-05.96	101		RLE	F 01G 061 0P3		
			11.92-05.96	101		RLE	F 01G 061 0P3		
	2.0 i16V 4WD		11.92-05.96	101		RLE	F 01G 061 0P3		
			11.92-05.96	101		RLE	F 01G 061 0P3		
	1.8 i16V		11.92-05.96	93		RLE	0986 AB8 917	15,88	
			11.92-05.96	110		RLE	0986 AB8 917	15,88	
	2.0 iV6-24		11.92-04.95	110		RLE	0986 AB8 917	15,88	
			11.92-05.96	101		RLE	0986 AB8 917	15,88	
	2.0 i16V, i16V 4WD		11.92-05.96	101		RLE	0986 AB8 917	15,88	
			11.92-05.96	101		RLE	0986 AB8 917	15,88	
	2.0 D Turbo, i16V, i16V 4WD		11.92-10.96	66-69/101			F 026 A02 565		
			11.92-10.96	66-69/101			F 026 A02 565		
	2.5 iV6-24		11.92-05.96	125		RLE	F 01G 09D 00H ^H		
			11.92-05.96	101			F 01G 09E 012 ^H		
	2.5 iV6-24		11.92-05.96	125			F 01G 09E 012 ^H		
			11.92-05.96	125			F 01G 09E 012 ^H		
Galant Station Wagon									
	2.5 iV6-24		10.96-09.02	118		LLE,TKO	F 01G 09C 0UR		F 01G 09C 1LK ⁶
			10.96-09.02	118		LLE,TKO	F 01G 09C 0UR		F 01G 09C 1LN ⁶
			10.96-09.02	118		RLE	F 01G 09C 0UN		F 01G 09C 1LK ⁶
	2.5 iV6-24		10.96-09.02	118		LLE,TKO	F 01G 09B 15D		
			10.96-09.02	118		RLE	F 01G 09B 15C		
	2.5 iV6-24		10.96-10.01	118			F 026 A06 047		
			11.01-09.02	118			F 026 A06 056		
Galant Station Wagon [EA]									
	2.0 D Turbo	ABO	10.96-09.02	66/100		LLE	F 01G 09C 10S		F 01G 09C 1LW ⁶
			10.96-09.02	66/100		RLE	F 01G 09C 10T		F 01G 09C 1LW ⁶
	2.0 i16V	ABS	10.96-09.02	66/100		LLE	F 01G 09C 0UR		F 01G 09C 1LK ⁶
			10.96-09.02	66/100		RLE	F 01G 09C 0UN		F 01G 09C 1LK ⁶
	2.4 GDI		12.98-09.02	110		LLE	F 01G 09C 0UR		F 01G 09C 1LK ⁶
			12.98-09.02	110		RLE	F 01G 09C 0UN		F 01G 09C 1LK ⁶
	2.0 D Turbo	ABO	10.96-02.00	66		RLE	F 01G 09B 105		
			10.96-09.02	100		LLE	F 01G 09B 106		
	2.0 i16V		10.96-09.02	100		RLE	F 01G 09B 104		
		ABS	10.96-09.02	100		LLE	F 01G 09B 15D		
	2.4 GDI		01.99-09.02	110		RLE	F 01G 09B 15C		
			01.99-09.02	110		LLE	F 01G 09B 184		
	2.0 D Turbo		10.96-02.00	66			F 026 A06 047		
			10.96-10.01	100			F 026 A06 047		
	2.0 i16V		11.01-09.02	100			F 026 A06 056		
			12.98-10.01	110			F 026 A06 047		
	2.4 GDI		11.01-09.02	110			F 026 A06 056		
			11.01-09.02	110			F 026 A06 056		



























								
Grandis								
								
 2.4			01.04-05.05	121			F 026 A06 056	
i-MiEV								
								
			10.10→	47-49			0 265 005 574	
L 200								
								
 2.5 D Turbo			07.02-12.03	64			F 01G 09B 0S7	
L 200 Forte [K7]								
								
 2.4 i 4x4	ABO	01.96-05.02	97		JBH		0 986 480 861	
	ABS	01.96→	97				F 026 A01 720	
2.5 D Turbo Interc.	ABO	01.97-06.98	73-85		JBH		0 986 480 861	
	ABS	01.97→	73-85				F 026 A01 720	
 2.5 D Turbo Interc.			01.97-06.98	73-85			F 01G 09B 156	
 2.4 i 4x4		01.96-05.99	97				F 026 A01 822	
		06.99→	97				F 026 A06 908	
2.5 D Turbo Interc.		01.97-05.99	73-85				F 026 A01 822	
		06.99→	73-85				F 026 A06 908	
 2.5 D Turbo Interc.			01.97→	73-85			F 026 A07 708	
L 200 [KA]								
								
 2.5 DI-D	ABO	04.10→	94-100				F 026 A09 636	
	OFD	04.10→	94-100				F 01G 062 02R	F 01G 062 04N ⁶
 2.5 DI-D			04.10→	94-100		TW	0 986 AB8 914	19,05
 2.5 DI-D			04.10→	94-100			F 026 A09 638	
 2.5 DI-D		04.10-06.10	94-100			TW	F 01G 060 0KE ^A	
							F 01G 060 0LT ^A	
 2.5 DI-D			04.10→	94-100			0 265 005 574	
L 200 [KB]								
								
 2.5 DI-D 4x4	ABO	12.05→	100/123/131				F 026 A09 636	
	OFD	12.05→	100/123/131				F 01G 062 02R	F 01G 062 04N ⁶



		S							
◀ MITSUBISHI L 200 [KB]									
	2.5 DI-D 4x4	12.05→	100/123/ 131			TW	0 986 AB8 914	19,05	
	2.5 DI-D 4x4	12.05→	100/123/ 131				F 026 A09 638		
	2.5 DI-D 4x4	12.05→	100/123/ 131			TW	F 01G 060 0KD^A F 01G 060 0LT^A		
	2.5 DI-D 4x4	03.10→	100/123/ 131				0 265 005 574		
L 200 [K0-K3]									
	1.6	07.91-05.94	48				F 01G 09C 0RH		
		06.94-03.95	48			LLE	F 01G 09C 0RJ		
	2.0 2WD	11.89-05.95	65			LLE	F 01G 09C 0RH		
						RLE	0 986 480 734	23,8	
	2.0 4WD	11.89-05.94	65				0 986 480 734	23,8	
	2.4 i 2WD, i 4WD	06.90-11.97	82-87				0 986 480 734	23,8	
	2.5 D Turbo 4WD, D 2WD	11.89-03.01	54/73				0 986 480 734	23,8	
	2.6 4x4	11.89-05.95	76				F 01G 09C 0RH		
	2.5 D Turbo 4WD	10.84-03.01	54/73				F 026 A01 822		
	2.5 D 2WD								
	2.5 D Turbo 4WD	10.84-03.01	54/73				F 026 A02 579		
	2.5 D 2WD								
L 200 [K6/K7]									
	2.0 i 16V	01.96-06.98	90			JBH	0 986 480 861		
	2.4 i 4WD	ABO 01.96-05.02	97			JBH	0 986 480 861		
		ABS 01.96-12.07	97				F 026 A01 720		
	2.5 D, D Turbo Interc. 2WD,	ABO 06.95-06.98	55-64/73-85			JBH	0 986 480 861		
	D Turbo Interc. 4WD, D 2WD, D 4WD	ABS 06.95-12.07	55-64/73-85				F 026 A01 720		
	2.0 i 16V	01.96-06.98	90				F 01G 09B 0ZY		
	2.5 D Turbo Interc. 2WD, D 2WD	ABO 06.95-06.98	55-64/74-85				F 01G 09B 0ZX		
	2.5 D, D Turbo Interc. 4WD, D 4WD	01.96-06.98	64/73-85				F 01G 09B 156		
	2.0 i 16V	01.96-05.99	90				F 026 A01 822		
		06.99-06.01	90				F 026 A06 908		
	2.4 i 4WD	01.96-05.99	97				F 026 A01 822		
		06.99-12.07	97				F 026 A06 908		
	2.5 D Turbo Interc. 2WD	01.96-05.99	74-85				F 026 A01 822		
		06.99-12.07	74-85				F 026 A06 908		
	2.5 D Turbo Interc. 4WD	01.96-10.97	73-85				F 026 A01 822		
	2.5 D, D 2WD, D 4WD	06.95-05.99	55-64				F 026 A01 822		
		06.99-06.01	55-64				F 026 A06 908		
	2.0 i 16V	01.96-06.01	90				F 026 A02 579		
	2.5 D Turbo Interc. 2WD	01.96-12.07	74-85				F 026 A02 579		
	2.5 D Turbo Interc. 4WD	01.96-12.07	73-85				F 026 A07 708		
	2.5 D 2WD	06.95-06.01	55-64				F 026 A02 579		



									
L 300 Truck [L]									
									
	1.6	11.86-05.94	48-51				F 01G 09B 0RX		
	2.5 D	11.86-05.94	52				F 026 A01 922		
	2.5 D	11.86-05.94	52				F 026 A02 579		
L 300 Truck [P]									
									
	2.5 D Turbo	06.94-12.01	64		RLE		F 01G 09B 15G		
	2.5 D Turbo	06.94-12.01	64				F 026 A06 028		
	2.5 D Turbo	06.94-12.01	64				F 026 A02 610		
L 300 Van [P]									
									
	1.6 2WD	11.86-05.94	48-51		FKR,RLE	F 026 A01 681			
					FLR,LLE	0 986 480 729	23,8		
					FLR,RLE	F 026 A01 680			
	2.0 i 2WD	11.88-12.01	65/66		FKR,RLE	F 026 A01 681			
	2.0 2WD				FLR,LLE	0 986 480 729	23,8		
					FLR,RLE	F 026 A01 680			
	2.4 i 2WD, i 4WD	11.88-05.94	82			0 986 480 729	23,8		
	2.5 D Turbo 4WD	11.88-12.01	62-64			0 986 480 729	23,8		
	2.5 D 2WD	11.86-12.00	51-53		LLE	0 986 480 729	23,8		
					RLE	F 026 A01 680			
	2.0 i 2WD	09.99-12.01	65		FKR,LLE	F 01G 09B 1T1			
					FKR,RLE	F 01G 061 0R0			
					FLR,LLE	F 01G 061 0PT			
	2.5 D Turbo 4WD	11.88-09.99	62-64		FLR	F 01G 09B 15E			
	2.5 D 2WD	09.99-12.00	51-53		LLE	F 01G 061 0R2			
					RLE	F 01G 061 0R1			
	2.4 i 2WD, i 4WD	11.88-05.94	82			F 026 A01 922			
	2.5 D Turbo 4WD	11.86-11.98	51-53/62-64			F 026 A01 922			
	2.5 D 2WD	12.98-12.01	51-53/62-64			F 026 A06 028			
	2.4 i 2WD, i 4WD	11.88-05.94	82			F 026 A02 610			
	2.5 D Turbo 4WD, D 2WD	08.87-12.01	51-53/62-64			F 026 A02 610			
L 300 Wagon [P]									
									
	1.6	11.86-05.94	48-51			0 986 480 729	23,8		
	2.4 i 2WD, i 4WD	11.88-05.96	82			0 986 480 729	23,8		
	2.5 D Turbo 4WD	12.87-05.96	62-64			0 986 480 729	23,8		
	2.5 D 2WD long	11.86-12.00	51		LLE	0 986 480 729	23,8		
					RLE	F 026 A01 680			
	2.5 D 2WD short	11.86-08.97	51			0 986 480 729	23,8		



		S							
◀ MITSUBISHI L 300 Wagon [P]									
	2.5 D Turbo 4WD	11.88-05.96	62-64					F 01G 09B 15E	
	2.5 D 2WD long	09.99-12.00	51			LLE		F 01G 061 0R2	
						RLE		F 01G 061 0R1	
	2.4 i 2WD, i 4WD	11.88-05.96	82					F 026 A01 922	
	2.5 D Turbo 4WD	12.87-05.96	62-64					F 026 A01 922	
	2.5 D 2WD long	12.87-12.00	51					F 026 A06 028	
	2.5 D 2WD short	11.86-08.97	51					F 026 A01 922	
	2.4 i 2WD, i 4WD	11.88-05.96	82					F 026 A02 610	
	2.5 D Turbo 4WD, D 2WD long, D 2WD short	08.87-12.00	51/62-64					F 026 A02 610	
L 400									
	2.0 i	ABO	12.94-03.01	83-85				F 026 A01 766	
	2.4 i		12.94-03.01	97				F 026 A01 767	
	2.5 D Turbo 2WD, D Turbo 4WD	ABO	12.94-03.01	64				F 026 A01 767	
	2.0 i		12.94-03.01	83-85		FKR,RLE		F 01G 09B 107	
						FLR,RLE		F 01G 09B 185	
		ABS	12.94-03.01	83-85		LLE		F 01G 09B 187	
	2.4 i		12.94-03.01	97				F 01G 09B 187	
	2.5 D Turbo 2WD	ABO	12.94-03.01	64		LLE		F 01G 09B 108	
		ABS	12.94-03.01	64		LLE		F 01G 09B 188	
						RLE		F 01G 09B 186	
	2.5 D Turbo 4WD		12.94-03.01	64				F 01G 09B 188	
	2.5 D Turbo 2WD		12.94-03.01	64		RLE		F 026 A01 929	
	2.4 i		12.94-03.01	97				F 026 A02 610	
	2.5 D Turbo 2WD, D Turbo 4WD		12.94-03.01	64				F 026 A02 610	
Lancer									
	1.6 i		05.00-02.03	77-81				F 01G 062 097	
		ABS	07.99-02.01	81					F 01G 09C 1LJ⁶
	1.8 i		01.90→	91				F 01G 09C 0TV	
	1.8 i Turbo 4WD		07.96-05.00	151				F 026 A01 660	
	2.0 i Turbo 4WD		01.01-08.04	206				F 026 A01 660	
	1.6 i		05.00-02.03	77-81				F 01G 061 0R3	
	1.6 i		07.99-02.01	81				F 026 A01 905	
	1.6 i		07.99-02.01	81				F 026 A06 047	
	1.6 i		07.99-02.01	81				F 01G 09D 04A^H	
								0265 216 498^B	
	1.8 i		01.90→	91				F 01G 09D 04A^H	
								0265 216 498^B	





Lancer [CA/CB/CD]



	1.3i	ABO	07.93-12.96	58		LLE	0 986 480 662	20,6
		ABS	07.93-12.96	58			F 01G 09C 0TA	
	1.6i 16V	ABO	05.92-12.96	83		LLE	0 986 480 662	20,6
			12.93-12.96	66			0 986 480 662	20,6
		ABS	05.92-12.96	83		LLE	F 01G 09C 0TA	
						RLE	F 01G 09C 0T5	
			12.93-12.96	66			F 01G 09C 0TA	
	1.8i 16V	ABS	05.92-12.96	100-103		LLE	F 01G 09C 0TA	
						RLE	F 01G 09C 0T5	
	2.0D	ABS	05.92-12.96	50/54		LLE	F 01G 09C 0TA	

	1.3i	ABO	07.93-12.96	58		RLE	F 01G 09B 0XZ	
			12.91-10.96	67			F 01G 09B 0XZ	
	1.6i 16V	ABO	05.92-12.96	83		RLE	F 01G 09B 0XZ	
		ABS	05.92-12.96	83		RLE	F 01G 09B 151	
	1.8i 16V	ABO	05.92-12.96	100-103		LLE	F 01G 09B 101	
		ABS	05.92-12.96	100-103		RLE	F 01G 09B 151	
	2.0D		05.92-12.96	50/54		RLE	F 01G 061 0NZ	
		ABO	05.92-12.96	50/54		LLE	F 01G 09B 27F	

	1.3i		07.93-03.96	58			F 026 A01 877	
		1.6i 16V		05.92-03.96	83	RLE	F 026 A01 877	
	04.96-12.96		66		F 026 A01 905			
			83	LLE	F 026 A01 905			
	1.8i 16V		05.92-03.96	100-103		RLE	F 026 A01 877	
			04.96-12.96	100-103		LLE	F 026 A01 905	
	2.0D		05.92-03.96	50/54		RLE	F 026 A01 880	
			04.96-12.96	50/54		RLE	F 026 A01 923	

	1.6i 16V		05.92-12.96	66/83			F 026 A02 565	
		1.8i 16V		05.92-12.96	100-103		F 026 A02 565	
			2.0D		05.92-12.96	50/54		F 026 A02 565

Lancer [CC]



	1.5		10.92-06.96	65		STB	F 026 A01 692	
		1.8		10.92-12.94	86	4SB,SED	F 026 A01 695	
				10.92-06.96	86	KOB,STB	F 026 A01 693	

	1.5		10.92-06.96	65			F 01G 09B 0XZ	
--	------------	--	-------------	----	--	--	----------------------	--

Lancer [CK/CP/CN]



	1.3i 12V	ABS	11.95-05.01	55				F 01G 09C 1LJ ⁶
		1.5		07.96-09.00	67-69		F 026 A01 660	

	1.3i 12V		11.95-05.01	55			F 026 A01 905	
		1.5		11.95-09.00	67-69		F 026 A01 905	
			1.6i 16V		11.95-09.00	66		F 026 A01 905



























	1.3i 12V		11.95-05.01	55			F 026 A06 047	
		1.5		11.95-09.00	67-69		F 026 A06 047	
			1.6i 16V		11.95-09.00	66		F 026 A06 047

	1.3i 12V		11.95-05.01	55			F 01G 09D 04A ^H	
--	-----------------	--	-------------	----	--	--	-----------------------------------	--



		S							
◀ MITSUBISHI									
Lancer [CS/CT]									
	1.3 i	06.03-05.04	60	LLE		F 01G 09C 0XJ		F 01G 09C 1LK ⁶	
				RLE		F 01G 09C 0XL		F 01G 09C 1LK ⁶	
		06.04-04.10	60	LLE		F 01G 09C 12F		F 01G 09C 1GJ ⁶	
				RLE		F 01G 062 0AG		F 01G 09C 1GJ ⁶	
	1.6 i	06.03-05.04	72	AG,LLE		F 01G 09C 0XK		F 01G 09C 1LK ⁶	
				AG,RLE		F 01G 09C 0WU		F 01G 09C 1LK ⁶	
			GS,LLE		F 01G 09C 0XJ		F 01G 09C 1LK ⁶		
			GS,RLE		F 01G 09C 0XL		F 01G 09C 1LK ⁶		
		06.04-04.10	72	AG,LLE		F 01G 09C 12G		F 01G 09C 1GJ ⁶	
				AG,RLE		F 01G 09C 12Y		F 01G 09C 1GJ ⁶	
				GS,LLE		F 01G 09C 12F		F 01G 09C 1GJ ⁶	
				GS,RLE		F 01G 062 0AG		F 01G 09C 1GJ ⁶	
	2.0 i	06.02-05.04	99			F 01G 09C 0XJ		F 01G 09C 1LK ⁶	
		06.04-04.10	99	AG,LLE		F 01G 09C 12G		F 01G 09C 1GJ ⁶	
				GS,LLE		F 01G 09C 12F		F 01G 09C 1GJ ⁶	
				RLE		F 01G 062 0AG		F 01G 09C 1GJ ⁶	
	1.3 i	06.03-04.10	60	RLE		F 01G 09B 1HF			
	1.6 i	06.03-04.10	72	RLE		F 01G 09B 1HF			
	2.0 i	06.02-04.10	99	RLE		F 01G 09B 1HF			
	2.0 i	06.02-04.10	99	LLE		F 026 A05 939			
	1.3 i	06.03-04.10	60			F 026 A06 056			
	1.6 i	06.03-04.10	72			F 026 A06 056			
	2.0 i	06.02-04.10	99			F 026 A06 056			
Lancer [CY/CZ]									
	1.6	03.11→	86			F 026 A06 056			
	1.5	04.10-09.11	80			0 265 005 550			
	1.6	07.10→	86			0 265 005 550			
	1.8, DI-D	04.10→	85/103-105/110			0 265 005 550			
	2.0 DI-D	04.10-08.10	103			0 265 005 550			
Lancer [C1/C3]									
	1.5	07.93-12.94	51-55			F 01G 09C 0ND			
Lancer [C6/C7]									
	1.3	04.88-07.95	44	JBH		0 986 480 733	22,2		
	1.5 12V	06.92-07.95	67	JBH		0 986 480 733	22,2		
Lancer EvoX [CY/CZ]									
	2.0 i Turbo 4x4	08.07→	217			F 026 A02 606			
	2.0 i Turbo 4x4	04.10→	217			0 265 005 550			



		S							
Lancer Evo4 [CK/CP/CN]									
									
	2.0i Turbo	08.96-06.97	199				F 026 A01 660		
	2.0i Turbo	08.96-06.97	199				F 01G 09B 1B0		
	2.0i Turbo	08.96-06.97	199				F 026 A01 905		
	2.0i Turbo	08.96-06.97	199				F 026 A02 606		
	2.0i Turbo	08.96-06.97	199				F 01G 09D 04A^H		
Lancer Evo5/6 [CK/CP/CN]									
									
	2.0i Turbo	01.98-09.00	206			LLE RLE	F 01G 09C 100 F 01G 09C 0TW		
	2.0i Turbo	01.98-09.00	206				F 01G 09B 1B0		
	2.0i Turbo	01.98-09.00	206				F 026 A01 905		
	2.0i Turbo	01.98-09.00	206				F 026 A02 606		
	2.0i Turbo	01.98-09.00	206				F 01G 09D 054^H		
Lancer Evo7 [CS/CT]									
									
	2.0i Turbo 4x4	ABO 12.00-12.03	206			LLE RLE	F 01G 19C 032 F 01G 19C 031	F 01G 09C 1GG⁶ F 01G 09C 1GG⁶	
		ABS 12.00-12.03	206			LLE RLE	F 01G 19C 02Y F 01G 19C 02X	F 01G 09C 19Y⁶ F 01G 09C 19Y⁶	
	2.0i Turbo 4x4	12.00-12.03	206			RLE	F 01G 09B 1HB		
	2.0i Turbo 4x4	12.00-12.03	206				F 026 A02 606		
Lancer Evo8 [CS/CT]									
									
	2.0i Turbo 4x4	09.02-07.05	195			LLE RLE	F 01G 19C 02Y F 01G 19C 02X	F 01G 09C 19Y⁶ F 01G 09C 19Y⁶	
	2.0i Turbo 4x4	09.02-07.05	195			RLE	F 01G 061 04D		



		S							
◀ MITSUBISHI Lancer Evo8 [CS/CT]									
	2.0 i Turbo 4x4	09.02-07.05	195					F 026 A02 606	
Lancer Evo9 [CS/CT]									
	2.0 i Turbo 4x4	08.05-06.07	206			LLE	F 01G 19C 02Y	F 01G 09C 19Y⁶	
						RLE	F 01G 19C 02X	F 01G 09C 19Y⁶	
	2.0 i Turbo 4x4	08.05-06.07	206			RLE	F 01G 061 04D		
	2.0 i Turbo 4x4	08.05-06.07	206				F 026 A02 606		
Lancer Hatchback [C6/C7]									
	1.3 i	06.92-07.95	55			JBH	0 986 480 733	22,2	
	1.6 i 16V	ABO 06.92-07.95	83			JBH	0 986 480 733	22,2	
	1.6 i 16V 4WD	06.92-07.95	83			JBH	0 986 480 733	22,2	
	1.8 i 16V	ABO 06.92-07.95	103			JBH	0 986 480 733	22,2	
	2.0 D	06.92-07.95	50			JBH	0 986 480 733	22,2	
	2.0 D	06.92-07.95	50				F 01G 09B 0N7		
	1.6 i 16V, i 16V 4WD	06.92-07.95	83			RLE	F 026 A07 595		
	1.8 i 16V	06.92-07.95	103			RLE	F 026 A07 594		
	1.6 i 16V, i 16V 4WD	06.92-07.95	83				F 026 A02 565		
	1.8 i 16V	06.92-07.95	103				F 026 A02 565		
	2.0 D	06.92-07.95	50				F 026 A02 565		
Lancer [MG21/41]									
	1.5 i	07.96-08.04	64				F 026 A01 660		
	2.0 D	09.98→	50				F 01G 061 0NZ		
	1.5 i	09.88-12.00	64				F 026 A02 578		
Lancer Ralliart [CY/CZ]									
	2.0 4x4	04.10-06.12	177				0 265 005 550		
Lancer Sedan [CA/CB/CD]									
	1.6 i 16V	01.93-12.96	83				0 986 480 662	20,6	
		ABS 01.93-12.96	83				F 01G 09C 0TA		
	1.5 i	07.93-12.97	68				F 01G 09B 0XZ		























		S							
	1.5 i	07.93-12.97	68				F 026 A01 877		
	1.6 i16V	01.93-12.96	83				F 026 A01 877		
	1.6 i16V	01.93-12.96	83				F 026 A02 565		
Lancer Sedan [CK/CP/CN]									
	1.8 i	07.96-05.01	85				F 026 A01 660		
	1.8 i	05.96-05.01	85				F 026 A01 905		
	1.8 i	05.96-05.01	85				F 026 A06 047		
	1.8 i	05.96-05.01	85				F 01G 09D 04A^H		
Lancer Sportback [CX]									
	1.6	03.11→	86				F 026 A06 056		
	1.5	04.10-06.10	80				0 265 005 550		
	1.6	07.10→	86				0 265 005 550		
	1.8, DI-D	04.10→	85/103/110				0 265 005 550		
	2.0 DI-D	04.10-08.10	103				0 265 005 550		
Lancer Sportback Ralliart [CX]									
	2.0 4x4	04.10-09.11	177				0 265 005 550		
Lancer Station Wagon [CA/CB/CD]									
	1.6 i16V	ABS 06.92-09.00	83			LLE	F 01G 09C 0TA		
	1.6 i16V 4WD					RLE	F 01G 09C 0T5		
	2.0 D	ABS 06.92-05.96	50				F 01G 09C 0TA		
			54			LLE	F 01G 09C 0TA		
	1.6 i16V	ABO 06.92-09.00	83			LLE	F 01G 09B 101		
	1.6 i16V 4WD	ABS 06.92-09.00	83			RLE	F 01G 09B 151		
	2.0 D	06.92-05.96	54			RLE	F 01G 061 0NZ		
		ABO 06.92-05.96	50				F 01G 09B 27F		
			54			LLE	F 01G 09B 27F		
	1.6 i16V	06.92-03.96	83			RLE	F 026 A01 877		
	1.6 i16V 4WD	04.96-09.00	83			LLE	F 026 A01 905		
	2.0 D	06.92-05.96	50/54			RLE	F 026 A01 880		
	1.6 i16V, i16V 4WD	06.92-09.00	83				F 026 A02 565		
	2.0 D	06.92-05.96	50/54				F 026 A02 565		
	1.6 i16V 4WD	06.92-09.00	83				F 01G 09D 00F^H		



		S							
◀ MITSUBISHI									
Lancer Station Wagon [CS/CT]									
	1.6 i	06.03-05.04	72			AG,LLE	F 01G 09C 0XK		F 01G 09C 1LK ⁶
						AG,RLE	F 01G 09C 0WU		F 01G 09C 1LK ⁶
						GS,LLE	F 01G 09C 0XJ		F 01G 09C 1LK ⁶
						GS,RLE	F 01G 09C 0XL		F 01G 09C 1LK ⁶
		06.04-06.08	72			AG,LLE	F 01G 09C 12G		F 01G 09C 1GJ ⁶
						AG,RLE	F 01G 09C 12Y		F 01G 09C 1GJ ⁶
						GS,LLE	F 01G 09C 12F		F 01G 09C 1GJ ⁶
						GS,RLE	F 01G 062 0AG		F 01G 09C 1GJ ⁶
	2.0 i	06.03-05.04	99			LLE	F 01G 09C 0XJ		F 01G 09C 1LK ⁶
						RLE	F 01G 09C 0XL		F 01G 09C 1LK ⁶
		06.04-06.08	99			LLE	F 01G 09C 12F		F 01G 09C 1GJ ⁶
						RLE	F 01G 062 0AG		F 01G 09C 1GJ ⁶
	1.6 i	06.03-06.08	72			RLE	F 01G 09B 1HF		
	2.0 i	06.03-06.08	99			RLE	F 01G 09B 1HF		
	2.0 i	06.03-06.08	99			LLE	F 026 A05 939		
	1.6 i	06.03-06.08	72				F 026 A06 056		
	2.0 i	06.03-06.08	99				F 026 A06 056		
Mirage [CE]									
	1.5 i	07.96-12.03	69				F 026 A01 660		
Outlander [CU]									
	2.0 i Turbo 4WD, i 2WD, i 4WD	06.04-09.07	100/148				F 01G 062 0AM		
	2.4 i 4x4	06.04-09.07	118				F 01G 062 0AM		
	2.0 i Turbo 4WD, i 2WD, i 4WD	06.04-09.07	100/148				F 01G 061 07T		
	2.4 i 4x4	09.03-05.04	118			RLE	F 01G 09B 1H3		
		06.04-09.07	118			LLE	F 01G 061 07T		
						RLE	F 01G 061 07U		
	2.0 i Turbo 4WD, i 2WD, i 4WD	02.03-09.07	100/148				F 026 A05 939		
	2.4 i 4x4	09.03-09.07	118				F 026 A05 939		
	2.0 i 2WD	02.03-09.07	100				F 026 A06 056		
	2.0 i 4WD	02.03-08.03	100				F 026 A06 047		
		09.03-09.07	100				F 026 A06 056		
	2.4 i 4x4	09.03-09.07	118				F 026 A06 056		
Outlander [CW]									
	2.0, Di-D 4x4, 4x4	04.10-12.12	103/108-110				0 265 005 550		
	2.2 Di-D, Di-D 4x4	04.10-12.12	103/115/130				0 265 005 550		
	2.4, 4x4	04.10-12.12	125				0 265 005 550		
	3.0 4x4	04.10-12.12	162				0 265 005 550		

		S							
Pajero Cabrio [V]									
	2.5 TD Interc.			12.90-05.01	73-77	JBH			0 986 480 861
	3000 V6	ABO		12.90-05.01	110/133	JBH			0 986 480 861
	3000 V6 24V	ABS		12.90-05.01	110/133				F 026 A01 720
	2.5 D 4WD			04.91-05.99	62				F 01G 09B 0XY
	2.5 TD Interc.			12.90-08.95	73-77				F 01G 09B 155
				09.95-05.01	73-77				F 01G 09B 1AZ
	2.5 D 4WD			04.91-05.99	62				F 026 A07 183
	3000 V6 24V			06.94-05.01	133	RLE			F 026 A07 183
	2.5 D 4WD			04.91-05.99	62				F 026 A02 576
	3000 V6			12.90-05.94	110				F 01G 09D 016 ^H
	3000 V6 24V			06.94-05.96	133				F 01G 09D 024 ^H
				06.96-05.01	133				F 01G 09D 02C ^H
Pajero IO									
	1.6 i 16V			02.99→	75				F 01G 09C 121
									F 01G 09C 1KF ⁶
Pajero [NH/NJ/NK]									
	3.0 i 4WD	ABO		05.91-07.97	109				F 026 A01 696
		ABS		05.91-10.96	109				F 026 A01 720
				11.96-07.97	109				F 026 A07 623
Pajero [NJ/NK/NL]									
	3.5 i	ABO		11.93-07.97	153-154				F 026 A01 696
				08.97-02.00	153-154				F 026 A07 622
		ABS		11.93-10.96	153-154				F 026 A01 720
				11.96-02.00	153-154				F 026 A07 623
Pajero Pinin [H]									
	1.8	ABO		10.99-02.05	84/88				F 01G 09C 122
	1.8 GDI	ABS		10.99-02.05	84/88	LLE			0 204 055 180
						RLE			F 01G 09C 121
	2.0 GDI	ABO		07.00-01.04	95				F 01G 09C 122
		ABS		07.00-01.04	95	LLE			0 204 055 180
						RLE			F 01G 09C 121
									F 01G 09C 1KF ⁶
	1.8 GDI			10.99-08.01	88				F 01G 09B 1SZ
		ABS		10.99-08.01	88	LLE			0 204 021 834 ^S
	2.0 GDI			07.00-01.04	95				F 01G 09B 1SZ
Pajero Sport [K]									
	2.5 TD	ABO		08.98-02.09	73-85/98	JBH			0 986 480 861
	2.5 TD+	ABS		08.98-02.09	73-85/98				F 026 A01 720



									
◀ MITSUBISHI Pajero Sport [K]									
	3.0iV6	ABO	07.96-02.09	130		JBH	0986 480 861		
		ABS	07.96-02.09	130			F 026 A01 720		
	2.5 TD		08.98-02.09	73-85/98		15Z	F 01G 09B 158		
	2.5 TD+					16Z	F 01G 09B 159		
	3.0iV6		07.96-02.09	130		RLE	F 026 A01 822		
	2.5 TD, TD+		08.98-02.09	73-85/98			F 026 A07 708		
	3.0iV6		07.96-02.09	130			F 026 A07 708		
Pajero Sport [KH]									
									
	2.5 DI-D	OFD	10.09→	131			F 01G 062 02R	F 01G 062 04N⁶	
	3.2 DI-D		07.08-09.09	120			F 01G 062 02R	F 01G 062 04N⁶	
	3.5		12.08-09.09	149			F 01G 062 02R	F 01G 062 04N⁶	
	2.5 DI-D		10.09→	131		TW	0986 AB8 914	19,05	
	3.2 DI-D		07.08-09.09	120		TW	0986 AB8 914	19,05	
	3.5		12.08-09.09	149		TW	0986 AB8 914	19,05	
	2.5 DI-D		10.09→	131			F 026 A09 638		
	3.2 DI-D		07.08-09.09	120			F 026 A09 639		
	3.5		12.08-09.09	149			F 026 A09 638		
	2.5 DI-D		10.09-02.10	131		TW	0265 005 574		
			03.10→	131			0265 005 574		
	3.0		03.10→	162-163			0265 005 574		
Pajero [V]									
									
	2.4 i		12.90-05.94	82-100		JBH	0986 480 861		
	2.5 TD		04.91-05.99	62		JBH	0986 480 861		
	2.5 TD Interc.	ABO	12.90-06.00	73-77		JBH	0986 480 861		
		ABS	12.90-06.00	73-77			F 026 A01 720		
	2.8 TD		07.95-02.98	92		JBH	0986 480 861		
	2.8 TD Interc.	ABO	11.93-04.00	103		JBH	0986 480 861		
	2.8 TD, TD Interc.	ABS	11.93-04.00	92/103			F 026 A01 720		
	3.0 i			06.92-02.98	110		JBH	0986 480 861	
				01.97-02.98	109		JBH	0986 480 861	
				04.99→	109			F 026 A01 720	
	3.5 V6-24	ABO	11.93-02.00	143-154		JBH	0986 480 861		
		ABS	11.93-02.00	143-154			F 026 A01 720		
	3000 V6	ABO	12.90-02.00	110/130		JBH	0986 480 861		
	3000 V6 24V	ABS	12.90-02.00	110/130			F 026 A01 720		
	2.5 TD		04.91-05.99	62			F 01G 09B 0XY		
	2.5 TD Interc.		12.90-08.95	73-77			F 01G 09B 155		
			09.95-06.00	73-77			F 01G 09B 1AZ		
	2.8 TD Interc.		11.93-08.95	103			F 01G 09B 155		
			09.95-08.99	103			F 01G 09B 1AZ		
		09.99-04.00	103			F 01G 061 0PA			
	2.5 TD		04.91-05.99	62			F 026 A07 183		
	2.5 TD Interc.		12.90-06.00	73-77		RLE	F 026 A07 183		
	2.8 D		06.94-05.99	92			F 026 A07 183		
	2.8 TD Interc.		11.93-05.94	103		RLE	F 026 A01 882		
			06.94-04.00	103		RLE	F 026 A01 893		





















		S							
	3.5 V6-24	11.93-05.94	143-154			RLE	F 026	A01 882	
		06.94-02.00	143-154			RLE	F 026	A01 893	
	3000 V6, V6 24V	12.90-02.00	110/130			RLE	F 026	A07 183	
	2.4 i	12.90-05.94	82-100				F 026	A02 576	
	2.5 TD	04.91-05.99	62				F 026	A02 576	
	2.6 4WD	04.91-05.95	88				F 026	A02 576	
	2.8 D	06.94-05.99	92				F 026	A02 582	
	2.8 TD Interc.	11.93-04.00	103				F 026	A02 580	
	3.5 V6-24	11.93-02.00	143-154				F 026	A02 607	
	2.5 TD Interc.	12.90-05.94	73-77				F 01G	09D 016^H	
		06.94-05.96	73-77				F 01G	09D 024^H	
		06.96-06.00	73-77				F 01G	09D 02C^H	
	2.8 TD	02.98-12.98	92				F 01G	09D 02C^H	
	2.8 TD Interc.	11.93-05.94	103				F 01G	09D 016^H	
		06.94-05.96	103				F 01G	09D 024^H	
		06.96-04.00	103				F 01G	09D 02C^H	
	3.0 i	02.98 →	109				F 01G	09D 02C^H	
	3.5 V6-24	11.93-05.94	143-154				F 01G	09D 016^H	
		06.94-05.96	143-154				F 01G	09D 024^H	
		06.96-02.00	143-154				F 01G	09D 02C^H	
	3000 V6	12.90-05.94	110				F 01G	09D 016^H	
	3000 V6 24V	06.94-05.96	130				F 01G	09D 024^H	
		06.96-02.00	130				F 01G	09D 02C^H	
Pajero [V60; V70]									
	3.2 DI-D 4WD	02.00-08.06	118-121			RLE	F 026	A06 927	
	3.5 GDI	02.00-08.06	149			RLE	F 026	A06 927	
	3.2 DI-D 4WD	02.00-08.06	118-121				F 026	A06 057	
Pajero [V80; V90]									
	3.2 DI-D	09.06-09.07	118-125/ 140				F 026	A06 057	
Sigma									
	3.0 i	12.90-03.96	130				F 01G	09C 0YK	
	3.0 i, i24V, i24V 4WS	12.90-03.96	130/151			RLE	F 01G	09B 17U	
							F 01G	09B 17T	
Space Gear									
	2.0 i	ABO 12.94-03.01	83-85				F 026	A01 766	
	2.4 i 2WD	ABO 12.94-03.01	94-97			AG	F 026	A01 766	
						GS	F 026	A01 767	
	2.4 i 4WD	ABO 12.94-03.01	94-97				F 026	A01 767	
	2.5 D Turbo Interc. 2WD	ABO 12.94-03.01	73				F 026	A01 767	
	2.5 D Turbo Interc. 4WD								
	2.5 D Turbo 2WD long	06.94-05.95	64				F 026	A01 767	
	2.5 D Turbo 2WD short	ABO 12.94-03.01	64				F 026	A01 767	



◀ MITSUBISHI Space Gear								
	2.0 i	12.94-03.01	83-85				F 01G 09B 187	
	2.4 i 2WD	12.94-03.01	94-97		LLE		F 01G 09B 187	
						RLE		F 01G 09B 185
	2.4 i 4WD	12.94-03.01	94-97				F 01G 09B 187	
	2.5 D Turbo Interc. 2WD	12.94-03.01	73				F 01G 09B 188	
	2.5 D Turbo Interc. 4WD							
	2.5 D Turbo 2WD long	06.94-05.95	64				F 01G 09B 186	
2.5 D Turbo 2WD short	12.94-03.01	64				F 01G 09B 188		
	2.4 i 2WD	12.94-03.01	94-97			RLE	F 026 A01 929	
	2.5 D Turbo 2WD long	06.94-05.95	64				F 026 A01 929	
	2.4 i 2WD, i 4WD	12.94-03.01	94-97				F 026 A02 610	
	2.5 D Turbo 2WD long	06.94-05.95	64				F 026 A02 610	
Space Runner								
	1.8 i	ABO 06.91-05.99	85-90				F 026 A01 658	
	1.8 i 16V 4WD	ABS 06.91-05.99	85-90				0986 480 844	25,4
	2.0 D Turbo	ABO 06.92-05.99	60				F 01G 09C 0YY	
		ABS 06.92-05.99	60				0986 480 844	25,4
	2.0 D Turbo	06.92-05.99	60				F 01G 09B 153	
	2.0 i 16V	ABS 05.99-04.00	98				F 01G 09B 1VT	
	2.4 GDI	05.99-04.00	110				F 01G 09B 1VW	
		05.99-08.02	110					0 204 221 924
		05.00-08.02	110				F 01G 09B 1VV	
	1.8 i	06.91-05.99	85-90			RLE	F 026 A01 876	
	1.8 i 16V 4WD							
	1.8 i, i 16V 4WD	06.91-05.99	85-90				F 026 A02 565	
	2.0 D Turbo	06.92-05.99	60				F 026 A02 565	
	2.0 i 16V	05.99-10.01	98				F 026 A06 047	
		11.01-08.02	98				F 026 A06 056	
	2.4 GDI	05.99-08.02	110				F 026 A06 047	
	1.8 i	06.91-08.94	85-90				F 01G 09D 019^H	
		09.94-05.96	85-90				F 01G 09D 047^H	
	1.8 i, i 16V 4WD	06.96-05.99	85-90				F 01G 09D 04C^H	
	1.8 i 16V 4WD	06.91-08.94	85-90				F 01G 09D 00D^H	
		09.94-05.96	85-90				F 01G 09D 047^H	
	2.0 D Turbo	06.92-05.96	60				F 01G 09D 047^H	
		06.96-05.99	60				F 01G 09D 04C^H	
	1.8 i	09.94-05.96	85-90				F 01G 09E 006^H	
		06.96-05.99	85-90				F 01G 09E 007^H	
	2.0 D Turbo	09.94-05.96	60				F 01G 09E 006^H	
		06.96-05.99	60				F 01G 09E 007^H	
	2.0 i 16V	05.99-08.02	98				F 01G 09E 007^H	
	2.4 GDI	05.99-08.02	110				F 01G 09E 007^H	
Space Wagon [N]								
	2.0 D Turbo	ABO 06.92-11.00	60				F 01G 09C 0YY	F 01G 09C 1LV⁶
	2.0 D Turbo, i 16V, i 16V 4WD	ABS 06.92-11.00	60/98-101				0986 480 844	25,4
	2.0 i 16V, i 16V 4WD	ABO 06.92-11.00	98-101				F 026 A01 658	
	2.4 i 16V	ABO 05.91-05.96	97				F 026 A01 658	
		ABS 05.91-05.96	97				0986 480 844	25,4



		S							
	2.0 D Turbo	06.92-11.00	60				F 01G 09B 153		
	2.0 i 16V	ABS 06.00-01.04	98				F 01G 09B 1VT		
	2.4 GDI	ABO 02.99-01.04	96-121				F 01G 09B 1VX		
	2.4 GDI 4WD	ABS 02.99-01.04	96-121				F 01G 09B 1VW		
	2.0 i 16V	06.92-11.00	98-101			RLE	F 026 A01 876		
	2.0 i 16V 4WD								
	2.0 D Turbo	06.92-11.00	60				F 026 A02 565		
	2.0 i 16V	06.92-11.00	98-101				F 026 A02 565		
		06.00-10.01	98				F 026 A06 047		
		11.01-01.04	98				F 026 A06 056		
	2.0 i 16V 4WD	06.92-11.00	98				F 026 A02 565		
	2.4 GDI, GDI 4WD	07.98-01.04	96-121/110				F 026 A06 047		
	2.4 i 16V	06.92-05.96	97				F 026 A02 565		
	2.0 D Turbo	06.92-08.94	60				F 01G 09D 019^H		
		09.94-05.96	60				F 01G 09D 047^H		
		06.96-11.00	60				F 01G 09D 04C^H		
	2.0 i 16V	06.92-08.94	98-101				F 01G 09D 019^H		
		09.94-05.96	98-101				F 01G 09D 047^H		
		06.96-11.00	98-101				F 01G 09D 04C^H		
	2.0 i 16V 4WD	06.92-08.94	98				F 01G 09D 00D^H		
		09.94-05.96	98				F 01G 09D 047^H		
		06.96-11.00	98				F 01G 09D 04C^H		
	2.4 i 16V	05.91-08.94	97				F 01G 09D 019^H		
		09.94-05.96	97				F 01G 09D 047^H		
	2.0 D Turbo	09.94-05.96	60				F 01G 09E 006^H		
		06.96-11.00	60				F 01G 09E 007^H		
	2.0 i 16V 4WD	09.94-05.96	98				F 01G 09E 00E^H		
		06.96-11.00	98				F 01G 09E 00L^H		
2.4 i 16V	09.94-05.96	97				F 01G 09E 006^H			
Spacestar [DG]									
									
	1.3 i	06.98-12.04	60			LLE	0 204 021 966		
						RLE	0 204 021 967		
	1.6 i	04.01-12.04	72			LLE	0 204 021 966		
						RLE	0 204 021 967		
	1.8 GDI	08.98-08.02	87-90			LLE	0 204 021 968		
						RLE	0 204 021 969		
	1.8 i	09.02-12.04	82			LLE	0 204 021 966		
					RLE	0 204 021 967			
1.9 Di-D	06.00-12.04	75/85			LLE	0 204 021 965			
					RLE	0 204 021 967			
	1.8 GDI	08.98-10.01	87-90				F 026 A06 047		
		11.01-08.02	87-90				F 026 A06 056		
	1.3 i	06.00-12.04	60				0 265 216 776^B		
	1.6 i	04.01-12.04	72				0 265 216 776^B		
	1.8 GDI, i	06.00-12.04	82/87-90				0 265 216 776^B		
	1.9 Di-D	06.00-12.04	75/85				0 265 216 776^B		
Triton [MJ]									
									
	2.5 DT 4x4	08.92-09.96	62			STB	F 026 A01 578		
	2.6, 4x4	08.92-09.96	79/84			STB	F 026 A01 578		
	3.0 4x4	08.91-09.96	109			STB	F 026 A01 578		





◀ MITSUBISHI

3000 GT





	3.0 i 24V Bi-Turbo 4WD 4WS	06.92-12.00	206-210			F 01G 09D 00C^H	
--	----------------------------	-------------	---------	--	--	----------------------------------	--

NISSAN



AD Van



	1.5 i	06.99-10.01	74-78			F 026 A01 739	
		11.01-12.06	74-78			F 01G 062 0AF	
	1.5 i	06.99-10.01	74-78			F 01G 09B 1F2	
		11.01-10.02	74-78			F 01G 09B 1UP	
		11.02-12.06	74-78			F 01G 09B 1UR	

Almera Hatchback [N15]

















	1.4 i	ABS	07.95-01.98	55-64		JBH	0 986 480 923	22,2
			02.98-10.99	55-64			F 01G 062 091	
		ABS, 11.99-04.00	55-64				F 01G 09C 0UX	
		ASR						
		ABS, 11.99-04.00	55-64				F 01G 062 091	
	1.6 i	ABS	07.95-01.98	66-73		JBH	0 986 480 923	22,2
			02.98-10.99	66-73			F 01G 062 091	
	2.0 D	ABO	05.96-04.00	55			F 01G 09C 105	
		ABS	07.95-01.98	55		JBH	0 986 480 923	22,2
			02.98-10.99	55			F 01G 062 091	
		ABS, 11.99-04.00	55				F 01G 09C 0UX	
		ASR						
		ABS, 11.99-04.00	55				F 01G 062 091	
	2.0 i		04.96-12.97	105			F 01G 09C 0UB	
			01.98-04.00	105			F 01G 062 091	
	1.4 i		02.98-04.00	55-64			F 01G 09B 19C	
	1.6 i		02.98-04.00	66-73			F 01G 09B 19C	
	2.0 i		02.98-04.00	105			F 01G 09B 19C	

Almera Hatchback [N16E]



	1.5 D Turbo	ABO	10.02-03.03	60			F 01G 062 0A4	
			04.03-11.06	60			F 01G 09C 11U	
		ABS	10.02-11.06	60			0 204 024 097	23,81
	1.5 i	ABO	01.00-01.01	66			F 01G 062 0A4	
			04.01-07.02	66			F 01G 09C 11U	
			08.02-11.06	72		LLE	F 01G 09C 11U	
						RLE	F 01G 09C 11V	
		ABS	01.00-05.01	66			0 204 055 175	
			06.01-07.02	66			0 204 024 097	23,81
			08.02-11.06	72		LLE	0 204 024 097	23,81
	1.8 i					RLE	0 204 021 712	23,81
		ABO	01.00-07.02	84			F 01G 062 0A4	
			08.02-11.06	85		LLE	F 01G 062 0A4	
					RLE	F 01G 09C 11L		

		S									
1.8 i		ABS	01.00-05.01	84			0 204 055 175				
			06.01-07.02	84			0 204 024 097	23,81			
		ABS, OFD	08.02-11.06	85		LLE	0 204 024 097	23,81			
						RLE	0 204 021 712	23,81			
		MFD	08.02-11.06	85		RLE	0 204 055 190				
			02.03-11.06	85		LLE	0 204 055 191				
2.2 D Turbo		ABO	01.00-02.03	81			F 01G 062 0A4				
			02.03-11.06	82		LLE	F 01G 062 0A4				
						RLE	F 01G 09C 11L				
		ABS	01.00-02.03	81			0 204 024 097	23,81			
		ABS, OFD	02.03-11.06	82		LLE	0 204 024 097	23,81			
						RLE	0 204 021 712	23,81			
		MFD	02.03-11.06	82/100		LLE	0 204 055 191				
						RLE	0 204 055 190				
	OFD	02.03-11.06	100		LLE	0 204 024 097	23,81				
				RLE	0 204 021 712	23,81					
1.5 i		ABO	01.00-07.02	66			F 01G 09B 1UH				
		ABS	01.00-03.01	66			0 204 021 858				
			04.01-07.02	66			F 01G 09B 1UK				
1.8 i		ABO	01.00-07.02	84			F 01G 09B 1UH				
		ABS	01.00-03.01	84			0 204 021 858				
			04.01-07.02	84			F 01G 09B 1UK				
2.2 D Turbo		MFD	02.03-11.06	85			0 204 024 760				
		ABO	01.00-09.00	81			F 01G 09B 1UG				
			10.00-08.02	81			F 01G 09B 1UH				
		ABS	01.00-09.00	81			F 01G 09B 1UJ				
			10.00-08.02	81			F 01G 09B 1UK				
	MFD	02.03-11.06	82/100			0 204 024 760					
1.5 i			08.02-11.06	72		RLE	F 026 A05 944				
		1.8 i	08.02-11.06	85		RLE	F 026 A05 944				
		2.2 D Turbo	02.03-11.06	82		RLE	F 026 A05 944				
1.5 i			01.00-11.06	66/72			F 026 A02 609				
		1.8 i	01.00-11.06	84/85			F 026 A02 609				
1.5 D Turbo			10.02-02.03	60			0 265 216 900 ^B				
			03.03-11.06	60			0 265 231 428 ^B				
		1.5 i		12.00-07.01	66			0 265 216 901 ^B			
				08.01-07.02	66			0 265 216 900 ^B			
				08.02-02.03	72			0 265 216 900 ^B			
		1.8 i		03.03-11.06	72			0 265 231 416 ^B			
				12.00-07.01	84			0 265 216 901 ^B			
				08.01-07.02	84			0 265 216 900 ^B			
		2.2 D Turbo			08.02-02.03	85			0 265 216 900 ^B		
					03.03-11.06	85			0 265 231 416 ^B		
					12.00-07.01	81			0 265 216 901 ^B		
					08.01-02.03	81			0 265 216 900 ^B		
					02.03-11.06	82/100			0 265 231 416 ^B		
		1.5 i			08.02-11.06	72			F 01G 09F OMT		
				1.8 i	08.02-11.06	85			F 01G 09F OMT		
2.2 D Turbo	02.03-11.06			82/100			F 01G 09F OMT				
Almera [H14/15/17]											
1.6 i			ABO, 01.00→	81			F 01G 062 0AA				
			ABS								
			1.8 i	ABO, 12.00→	88			F 01G 062 0AA			
			ABS								





◀ NISSAN Almera [H14/15/17]

	1.6 i		01.00→	81		F 01G 09B 1CK	
	1.8 i		12.00→	88		F 01G 09B 1CK	
		ABS	12.00→	88		F 01G 061 0PJ	

Almera Sedan [N15]



	1.4 i	ABS	07.95-01.98	55-64	JBH	0986 480 923	22,2
			02.98-10.99	55-64		F 01G 062 091	
			ABS, 11.99-04.00	55-64		F 01G 09C 0UX	
			ASR				
		ABS, 11.99-04.00	55-64		F 01G 062 091		
		OAS					
	1.6 i	ABS	07.95-01.98	66-73	JBH	0986 480 923	22,2
		02.98-10.99	66-73	F 01G 062 091			
	2.0 D	ABO	05.96-04.00	55		F 01G 09C 105	
		ABS	07.95-01.98	55	JBH	0986 480 923	22,2
			02.98-10.99	55		F 01G 062 091	
			ABS, 11.99-04.00	55		F 01G 09C 0UX	
			ASR				
		ABS, 11.99-04.00	55		F 01G 062 091		
		OAS					

	1.4 i		02.98-04.00	55-64		F 01G 09B 19C	
	1.6 i		02.98-04.00	66-73		F 01G 09B 19C	

Almera Sedan [N16]



	1.5 i	ABS	04.00-03.01	66		F 01G 062 091	
	1.8 i	ABS	04.00-03.01	84		F 01G 062 091	
	2.2 D Turbo	ABS	04.00-03.01	81		F 01G 062 091	

















	1.5 i	ABO	04.00-03.01	66		F 01G 09B 1UH	
		ABS	04.00-03.01	66		F 01G 061 0PJ	
	1.8 i	ABO	04.00-03.01	84		F 01G 09B 1UH	
		ABS	04.00-03.01	84		F 01G 061 0PJ	
	2.2 D Turbo	ABO	04.00-03.01	81		F 01G 09B 1UG	
		ABS	04.00-03.01	81		F 01G 09B 1UJ	

	1.5 i		04.00-03.01	66		F 026 A02 609	
	1.8 i		04.00-03.01	84		F 026 A02 609	

Almera Sedan [N16E]



	1.5 D Turbo	ABO	10.02-03.03	60		F 01G 062 0A4	
			04.03-11.06	60		F 01G 09C 11U	
		ABS	10.02-11.06	60		0204 024 097	23,81
	1.5 i	ABO	03.01-07.02	66		F 01G 09C 11U	
			08.02-11.06	72	LLE	F 01G 09C 11U	
					RLE	F 01G 09C 11V	
		ABS	03.01-05.01	66		0204 055 175	
			06.01-07.02	66		0204 024 097	23,81
			08.02-11.06	72	LLE	0204 024 097	23,81
					RLE	0204 021 712	23,81
	1.8 i	ABO	03.01-07.02	84		F 01G 062 0A4	
			08.02-11.06	85	LLE	F 01G 062 0A4	
				RLE	F 01G 09C 11L		
ABS		03.01-05.01	84		0204 055 175		
		06.01-07.02	84		0204 024 097	23,81	

		S								
1.8 i	ABS	08.02-11.06	85			LLE	0 204 024 097	23,81		
		OFD				RLE	0 204 021 712	23,81		
	MFD	08.02-11.06	85			RLE	0 204 055 190			
		02.03-11.06	85			LLE	0 204 055 191			
	2.2 D Turbo	ABO	03.01-02.03	81				F 01G 062 0A4		
			02.03-11.06	82			LLE	F 01G 062 0A4		
						RLE	F 01G 09C 11L			
		ABS	03.01-02.03	81				0 204 024 097	23,81	
		ABS	02.03-11.06	82			LLE	0 204 024 097	23,81	
		OFD					RLE	0 204 021 712	23,81	
MFD		02.03-11.06	82/100			LLE	0 204 055 191			
						RLE	0 204 055 190			
OFD	02.03-11.06	100			LLE	0 204 024 097	23,81			
					RLE	0 204 021 712	23,81			
	1.5 i	ABO	03.01-07.02	66			F 01G 09B 1UH			
		ABS	03.01-07.02	66			F 01G 09B 1UK			
	1.8 i	ABO	03.01-07.02	84			F 01G 09B 1UH			
		ABS	03.01-07.02	84			F 01G 09B 1UK			
		MFD	02.03-11.06	85			0 204 024 760			
	2.2 D Turbo	ABO	03.01-08.02	81			F 01G 09B 1UH			
		ABS	03.01-08.02	81			F 01G 09B 1UK			
		MFD	02.03-11.06	82/100			0 204 024 760			
		1.5 i	08.02-11.06	72			RLE	F 026 A05 944		
		1.8 i	08.02-11.06	85			RLE	F 026 A05 944		
2.2 D Turbo		02.03-11.06	82			RLE	F 026 A05 944			
	1.5 i	03.01-11.06	66/72				F 026 A02 609			
	1.8 i	03.01-11.06	84/85				F 026 A02 609			
	1.5 D Turbo	10.02-02.03	60				0 265 216 900 ^B			
		03.03-11.06	60				0 265 231 428 ^B			
	1.5 i	03.01-07.01	66				0 265 216 901 ^B			
		08.01-07.02	66				0 265 216 900 ^B			
		08.02-02.03	72				0 265 216 900 ^B			
		03.03-11.06	72				0 265 231 416 ^B			
	1.8 i	03.01-07.01	84				0 265 216 901 ^B			
		08.01-07.02	84				0 265 216 900 ^B			
		08.02-02.03	85				0 265 216 900 ^B			
		03.03-11.06	85				0 265 231 416 ^B			
	2.2 D Turbo	03.01-07.01	81				0 265 216 901 ^B			
		08.01-02.03	81				0 265 216 900 ^B			
		02.03-11.06	82/100				0 265 231 416 ^B			
		1.5 i	08.02-11.06	72				F 01G 09F 0MT		
		1.8 i	08.02-11.06	85				F 01G 09F 0MT		
		2.2 D Turbo	02.03-11.06	82/100				F 01G 09F 0MT		
Almera Tino [V10M]										
										
	1.8 i	05.00-02.03	84-85				0 204 055 176	23,81		
		MFD	03.03-12.05	84-85				0 204 055 193	23,81	
		OFD	03.03-12.05	84-85				0 204 055 176	23,81	
	2.0 i	05.00-01.03	99-100				0 204 055 176	23,81		
	2.2 D Turbo	05.00-01.03	81-84					0 204 055 176	23,81	
		MFD	02.03-12.05	82/100				0 204 055 193	23,81	
		OFD	02.03-12.05	82/100				0 204 055 176	23,81	
		1.8 i	05.00-07.02	84-85				0 204 024 273		
MFD			03.03-02.04	84-85				0 204 024 760		
			03.04-12.05	84-85				0 204 051 162		



		S							
NISSAN Almera Tino [V10M]									
		2.0 i	05.00-01.03	99-100			0 204 024 273		
		2.2 D Turbo	05.00-07.02	81-84			0 204 024 274		
			MFD 03.03-02.04	82/100			0 204 024 760		
			03.04-12.05	82/100			0 204 051 162		
		1.8 i	05.00-12.05	84-85			F 026 A02 609		
		1.8 i	05.00-11.00	84-85		BOG,GS	0 265 216 788 ^H		
			12.00-02.03	84-85		BMG,GS	0 265 216 902 ^H		
			03.03-12.05	84-85			0 265 231 418 ^B		
		2.0 i	05.00-11.00	99-100		BOG	0 265 216 790 ^H		
			12.00-01.03	99-100		BMG	0 265 216 903 ^H		
		2.2 D Turbo	05.00-11.00	81-84		BOG	0 265 216 788 ^H		
			05.00-01.03	81-84		BMG	0 265 216 902 ^H		
			02.03-12.05	82/100			0 265 231 418 ^B		
		1.8 i	05.00-12.05	84-85		AG	1 273 004 506 ^H		
						GS	1 273 004 505 ^H		
		2.0 i	05.00-01.03	99-100			1 273 004 506 ^H		
		2.2 D Turbo	05.00-01.03	81-84		GS	1 273 004 505 ^H		
Altima Coupé [CL32]									
		3.5	10.10→	198			0 265 251 460 ^B		
		3.5	12.07→	198			0 265 005 828		
Altima [L31]									
		2.5	09.01-12.06	131			F 026 A02 594		
		3.5	05.02-07.03	183			F 026 A02 594		
Altima [L32]									
		2.5	09.10→	127-131		TW	0 265 251 447 ^B		
							0 265 251 449 ^B		
		2.5	07.08→	127-131			0 265 005 828		
		3.5	08.07→	201			0 265 005 828		
Altima [U13]									
		2.4 i	ABS 06.92-05.97	110-112			F 01G 09C 0T1		F 01G 09C 15B ⁶
		2.4 i	06.92-05.97	110-112			0 265 206 016 ^H		
Armada [TA60]									
		5.6	10.04→	236			F 01G 09F 0MT		
		5.6 4x4							



		S								
Bluebird										
	1.8 i	09.91-11.95	92				F 01G 09B 024			
Bluebird [U13]										
	2.4 i	07.93-09.97	112				F 01G 09C 02H		F 01G 09C 155 ⁶	
Cabstar [F 24]										
	2.5 D Turbo	11.11→	90		LLE		0 204 054 632	26,99		
				RLE		0 204 054 631	26,99			
	2.5 D Turbo	11.11→	90		TW		0 204 051 528			
						0 204 051 539				
Cabstar [F24]										
	2.5 D Turbo	09.06→	81/96/100/ 107		LLE		0 204 054 632	26,99		
				RLE		0 204 054 631	26,99			
	3.0 D Turbo	09.06→	110		LLE		0 204 054 632	26,99		
				RLE		0 204 054 631	26,99			
	2.5 D Turbo	09.06-03.09	96		4T5,LLE		0 204 051 539			
						4T5,RLE		0 204 051 528		
			09.06-10.11	81 96				0 204 051 528		
						3T5		0 204 051 528		
			04.09-10.11	96		4T5		0 204 051 539		
						3T5		0 204 051 528		
			11.11→	100/107		3T5		0 204 051 528		
						4T5		0 204 051 539		
		3.0 D Turbo	09.06-03.09	110		4T5,LLE,MG5		0 204 051 528		
							4T5,LLE,MG6		0 204 051 539	
						4T5,RLE		0 204 051 528		
			09.06→	110		3T5		0 204 051 528		
		04.09→	110		4T5		0 204 051 539			
Cabstar ZZ										
	4.6	11.99→	90				F 01G 062 0A0			
Cedric Sedan [Y30]										
	2.0	08.85-07.95					F 01G 09C 0M4		F 01G 09C 14V ⁶	
	2.0	10.83-07.95					TW	F 01G 09B 0PW		
		10.85-07.95						TW	F 01G 09B 0VV	
	2.0	10.83-07.95					F 026 A02 516			



		S				?			
◀ NISSAN									
Cedric Wagon [Y30]									
	3.0						F 01G 09C 0M4		F 01G 09C 14V ⁶
	3.0						F 01G 09B 0VV		
Cefiro									
	2.0 i						0 265 216 658 ^H		
Cube [Z12]									
	1.5 dCi						0 265 005 821		
	1.6						0 265 005 821		
Evalia [M20M]									
	1.5 dCi						0 265 232 404 ^B		
	1.6						0 265 232 404 ^B		
E20									
	1.8								F 01G 09C 17N ⁶
	2.0						F 01G 09C 1HW		F 01G 09C 17K
Frontier									
	2.7 D		ABS				F 01G 09B 13Z		
Hardbody [D21]									
	2.7 TD 4x4						F 01G 09C 107		
	2.7 TD 4x4						F 01G 09B 0YY		
Hardbody [D22]									
	2.5 D Turbo	ABO					F 01G 09C 109		F 026 A07 977 ⁶
						TW	F 01G 062 087		F 01G 062 08S ⁶
	2.5 D Turbo	ABO					F 01G 061 0P8		
	2.5 D Turbo, D Turbo 4x4	ABS					F 01G 061 0LP		
	3.2 D 4x4					TW	F 01G 09B 1EK		
							F 01G 09B 13Z		
	2.5 D Turbo						F 01G 09D 03P ^B		
	2.5 D Turbo 4x4						F 01G 09D 03N ^B		



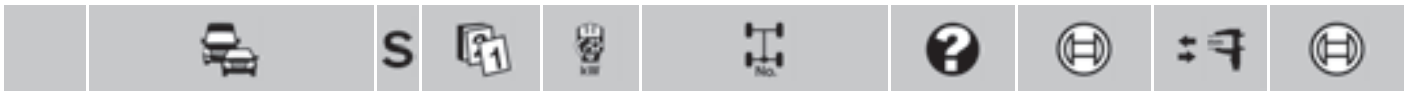

Interstar [X70]

	1.9 dCi 80	ABO 07.02-06.10	59-60			0 204 123 651	23,8
		ABS 07.02-11.03	59-60			0 204 123 409	
	2.2 dCi 90	ABO 07.02-06.10	66			0 204 123 651	23,8
		ABS 07.02-11.03	66			0 204 123 409	
	2.5 dCi 100, dCi 120	ABO 07.02-06.10	73-74/84-88			0 204 123 651	23,8
	2.5 dCi 120	ABS 07.02-11.03	84-88			0 204 123 409	
	3.0 D Turbo dCi 140	ABO 11.03-06.10	99-100			0 204 123 651	23,8

Kubistar [X76]

	1.1 i 8V	ABS 07.03-03.09	44		LLE	0 204 123 589	22,2
		ABO 07.03-03.09	44/55-56			F 026 003 372	22
	1.1 i 16V	ABS 07.03-03.09	55-56		LLE	0 204 123 589	22,2
					RLE,TW	0 204 123 589	22,2
	1.4 i	ABO 07.03-03.09	55			F 026 003 372	22
		ABS 07.03-03.09	55		LLE	0 204 123 589	22,2
	1.5 D Turbo 60, D Turbo 70, D Turbo 80	ABO 07.03-03.09	40-45/48-50/60-62			F 026 003 372	22
		ABS 07.03-03.09	40-45/48-50/60-62		LLE	0 204 123 589	22,2
	1.6 i	ABO 07.03-03.09	70-71			F 026 003 372	22
		ABS 07.03-03.09	70-71		LLE	0 204 123 589	22,2
					RLE,TW	0 204 123 589	22,2

	1.1 i 8V, i 16V	07.03-03.09	44/55-56		ERH,LLE	0 204 131 298	
	1.4 i	07.03-03.09	55		ERH,LLE	0 204 131 298	
	1.5 D Turbo 60, D Turbo 70, D Turbo 80	07.03-03.09	40-45/48-50/60-62		ERH,LLE	0 204 131 298	
	1.6 i	07.03-03.09	70-71		ERH,LLE	0 204 131 298	

Maxima [A35]

	3.5	07.09→	213			0 265 005 828	

Maxima [J30]

	3.0 i	04.91-06.94	122	Fg.-Nr. *GAEM*→			F 01G 09C 15B
		11.92-06.94	122	Fg.-Nr. *PAEM*→		F 026 A01 651	F 01G 09C 16V
		ABO 09.88-06.94	125/128			F 01G 09C 0PV	
		ABS 09.88-06.94	125/128			F 01G 09C 0SB	
	3.0 i	09.88-06.94	125/128			F 01G 09D 03U ^H	

Maxima QX [A32]

	2.0 i	ABS 10.94-01.00	103			F 01G 09C 0TH	
		ABS 10.94-01.00	142			F 01G 09C 0TH	
	2.0 i	10.94-01.99	103			F 01G 09B 16D	
		02.99-01.00	103			F 01G 09B 1EU	
	3.0 i	10.94-01.99	142			F 01G 09B 16D	
		02.99-01.00	142			F 01G 09B 1EU	





◀ NISSAN

Maxima QX [CA33]



	2.0 i	01.00-01.06	103	LLE	F 01G 09C OWD	F 01G 09C 15U⁶
	3.0 i	01.96→	147		F 026 A01 747	
		01.00-01.06	147	LLE	F 01G 09C OWD	F 01G 09C 15U⁶
	2.0 i	01.00-01.06	103	LLE	F 01G 09B 1DM	
	3.0 i	01.96→	147		F 01G 09B 16F	

Micra CC [K12E]



	1.4 i	OFD 09.05-10.10	65	JBH,LLE	0986 480 886	23,8
	1.6 i	OFD 09.05-10.10	81	JBH,LLE	0986 480 886	23,8
	1.4 i	09.05-09.07	65		0 265 234 282^T	
		09.05-10.10	65		0 265 231 842^B	
	1.6 i	09.05-09.07	81		0 265 234 284^T	
		09.05-10.10	81		0 265 231 842^B	
	1.4 i	09.05-10.10	65		0 265 005 265	
	1.6 i	09.05-10.10	81		0 265 005 265	

Micra [K11E]





















	1.0 i	ABO 05.95-10.02	40-44	JBH	0986 480 978	23,8
		ABS 08.92-07.00	40-44	LLE	0986 480 658	20,6
	1.3 i	ABO 05.95-07.00	55	JBH	0986 480 978	23,8
		ABS 08.92-07.00	55	LLE	0986 480 658	20,6
	1.4 i	ABO 07.00-10.02	60	JBH	0986 480 978	23,8
	1.5 D	02.98-07.00	42	JBH	0986 480 978	23,8
ABO 07.00-10.02		42	JBH	0986 480 978	23,8	
	1.0 i	ABO 08.92-07.00	40-44		0986 485 117	
	1.3 i	05.95-10.00	55		0986 485 117	
		ABO 08.92-07.00	55		0986 485 117	
	1.0 i	10.95-10.02	40-44		0 265 214 206^H	
	1.3 i	10.95-07.00	55		0 265 214 206^H	
	1.0 i	01.96-02.98	40-44	GS	0 265 108 024^H	
		03.98-07.00	40-44	AG	0 265 108 036^H	
				GS	0 265 108 041^H	
	1.3 i	12.95-02.98	55	GS	0 265 108 024^H	
		03.98-07.00	55	AG	0 265 108 036^H	
				GS	0 265 108 041^H	

Micra [K12E]



	1.0 i	OFD 11.02-05.05	48	JBH	0986 480 886	23,8
	1.2 i	OFD 11.02-05.05	48/59	JBH	0986 480 886	23,8
		06.05-10.10	48/59	JBH,LLE	0986 480 886	23,8
1.4 i	OFD 11.02-05.05	65	JBH	0986 480 886	23,8	
		06.05-10.10	65	JBH,LLE	0986 480 886	23,8
	1.5 D Turbo	02.03-10.10	48-50/60-63	JBH,LLE	0986 480 886	23,8
1.6 i	OFD 06.05-10.10	81	JBH,LLE	0986 480 886	23,8	

		S							
	1.0i	11.02-05.05	48				0 265 231 842 ^B		
	1.2i	11.02-10.10	48				0 265 231 842 ^B		
			59				0 265 231 842 ^B		
		06.05-09.07	48		AG		0 265 234 154 ^T		
					GS		0 265 234 123 ^T		
		59			AG		0 265 234 154 ^T		
					GS		0 265 234 123 ^T		
		MFD 09.03-05.05	48		AG		0 265 234 154 ^T		
			59		AG		0 265 234 154 ^T		
	1.4i	11.02-10.10	65				0 265 231 842 ^B		
		06.05-09.07	65		AG		0 265 234 154 ^T		
		MFD 09.03-05.05	65		GS		0 265 234 123 ^T		
					AG		0 265 234 154 ^T		
				GS		0 265 234 123 ^T			
			GS		0 265 234 123 ^T				
1.5 D Turbo	02.03-10.10	48-50/60-63				0 265 231 842 ^B			
1.6i	06.05-12.05	81		TW		0 265 234 284 ^T			
	06.05-09.07	81		TW		0 265 234 276 ^T			
	06.05-10.10	81				0 265 234 278 ^T			
						0 265 231 842 ^B			
	1.2i	08.03-10.10	48/59				0 265 005 265		
	1.4i	08.03-10.10	65				0 265 005 265		
	1.6i	06.05-10.10	81				0 265 005 265		
Micra [K13K]									
									
	1.2 DIG-S	07.13→	72		CVT,LLE		0 265 243 044 ^T		
					GS,LLE		0 265 243 045 ^T		
	1.2i	07.13→	59		LLE,TW		0 265 243 035 ^T		
							0 265 243 036 ^T		
				RLE,TW		0 265 243 037 ^T			
						0 265 243 038 ^T			
Murano [Z50]									
									
	3.5i 4x4	11.04-12.08	172				F 01G 09F OMT		
	3.5 4x4	09.02-08.05	180				F 01G 09F OMT		
Murano [Z51]									
									
	2.5 dCi 4x4	05.10-06.11	140				0 265 005 546		
Note [E11]									
									
	1.5 dCi 70	01.06-12.08	50		JBH		0 986 480 886	23,8	
	1.5 dCi 86, dCi 90, dCi 105	OFD 01.06→	63/66/76		JBH,LLE		0 986 480 886	23,8	
	1.6	OFD 01.06→	81		JBH,LLE		0 986 480 886	23,8	
	1.5 dCi 70	01.06-12.08	50				0 265 231 733 ^B		
	1.5 dCi 86	01.06→	63/66				0 265 231 733 ^B		
	1.5 dCi 90						0 265 235 048 ^T		
	1.5 dCi 105	01.08→	76				0 265 231 733 ^B		
	1.6	01.06→	81				0 265 231 733 ^B		
					AG		0 265 235 495 ^T		
				GS		0 265 235 046 ^T			





◀ NISSAN Note [E11]

	1.5 dCi 86, dCi 90, dCi 105	01.06→	63/66/76		0 265 005 265	
	1.6	01.06→	81		0 265 005 265	

Note [E11E]

	1.4	OFD 01.06→	65	JBH, LLE	0 986 480 886	23,8
	1.4	01.06→	65		0 265 231 733 ^B	
					0 265 235 044 ^T	
	1.4	01.06→	65		0 265 005 265	

NP300 [D22SS]

	2.5 dCi	08.10→	98	TW	F 01G 062 087	
	2.5 dCi	ABO 08.10→	98		F 01G 061 0LH	
		ABS 08.10→	98		F 01G 061 0LP	
	2.5 dCi 4x4	08.10→	98		F 01G 061 0LP	
	2.5 dCi 4x4	08.10→	98		F 01G 065 029	

NT 500 [G40M]

	35.15	12.13→	110		0 204 817 814	28,57
	56.15	12.13→	110		0 204 817 815	31,75
	65.15	12.13→	110		0 204 817 815	31,75
	35.15	12.13→	110		0 204 817 812	
	56.15	12.13→	110		0 204 817 813	
	65.15	12.13→	110		0 204 817 813	

NV200 [M20]

	1.5 dCi	08.09-05.10	63		0 265 232 404 ^B	
	1.6	08.09-05.10	81		0 265 230 857 ^T	
					0 265 232 404 ^B	

NV200 [M20M]

	1.5 dCi	11.09→	63/66/78		0 265 232 404 ^B	
	1.6	11.09-06.10	81		0 265 230 857 ^T	
		11.09→	81		0 265 232 404 ^B	

Pathfinder

	3.3 i	09.95-08.01	125	TW	F 01G 09C 0U7	
		02.00-08.01	125	TW	F 01G 09C 0WM	



		S								
Pathfinder [D21]										
	3.0i 4WD			07.92-07.95	113				F 026 A07 590	
	3.0i 4WD			07.92-07.95	113				F 01G 09B 16K	
	3.0i 4WD			07.92-07.95	113				F 026 A02 598	
Pathfinder [R50]										
	3.3i			09.95→	110-125			TW	F 01G 09C 0TX F 026 A01 664 F 026 A01 666	F 01G 09C 15J ⁶
	3.3i 4x4			10.97-02.00	110-125				F 01G 09C 0U7	
				03.00-07.02	110-125				F 01G 09C 0WM	
	3.5i			07.00-09.01	162			TOO	F 01G 09C 0U7	
								TW	F 01G 09C 0WM	
Patrol GR [Y60]										
	2.8 D Turbo			09.88-09.97	85				F 026 A01 583	
	4.2			08.87-09.97	125				F 026 A01 584	
	4.2 D			08.87-09.97	92				F 026 A01 584	
								STB	F 026 A01 584	
								4SB	F 026 A01 583	
	4.2i			10.91-09.97	118-121				F 026 A01 583	F 026 A03 379 ⁶
	4.2 D			08.87-10.94	92			MSU	F 026 A01 866	
				10.91-01.94	92			MSU	F 026 A07 589	
				10.94-07.96	92			MSU	F 026 A07 589	
	4.2 D			11.91-09.97	92				F 026 A07 703	
Patrol GR [Y61]										
	2.8 D Turbo	ABO		10.97-02.00	95-96				F 026 A01 721	
	2.8 D Turbo 4x4	ABS		10.97-02.00	95-96				F 026 A01 722	
	3.0 Di Hardtop 4x4			11.02-12.06	116				F 026 A01 722	
		ABS		02.00-10.02	116				F 026 A01 722	
	3.0 Di 4x4			11.02-12.06	116				F 026 A01 722	
		ABS		02.00-10.02	116				F 026 A01 722	
	4.2 D	ABO		10.97→	107				F 026 A01 721	
		ABS		10.97→	107				F 026 A01 722	
	4.5i	ABO		08.97→	147				F 026 A01 721	
		ABS		08.97→	147				F 026 A01 722	
	2.8 D Turbo			10.97-02.00	95-96				F 01G 09B 18U	
	2.8 D Turbo 4x4			10.97-02.00	95-96				F 01G 09B 18V	
	3.0 dCi 4x4			01.07-03.10	118			AG,LLE	F 01G 061 0LS	
								RLE	F 01G 061 0LS	
	3.0 Di Hardtop 4x4			02.00-07.01	116			LLE	F 01G 09B 1MS	
	3.0 Di 4x4							RLE	F 01G 09B 1MN	



		S							
NISSAN Patrol GR [Y61]									
		3.0 Di Hardtop 4x4	08.01-12.06	116		GS,LLE	F 01G 061 0LW		
		3.0 Di 4x4	08.01-03.10	116		AG,LLE RLE	F 01G 061 0LS F 01G 061 0LS		
		4.2 D	10.97→	107			F 01G 09B 18U		
		4.5 i	08.97→	147			F 01G 09B 18U		
		4.8	10.02-03.10	180-185		TW	F 01G 061 0LV		
		4.8 i 4x4	08.04→	190			F 01G 061 0LV		
		2.8 D Turbo	10.97-02.00	95-96			F 026 A07 611		
		2.8 D Turbo 4x4	10.97-02.00	95-96			F 026 A06 900		
		3.0 dCi 4x4, Di Hardtop 4x4, Di 4x4	02.00-03.10	116/118			F 026 A06 900		
		4.2 D	10.97→	107			F 026 A07 611		
		4.5 i	08.97→	147			F 026 A07 611		
		2.8 D Turbo	10.97-02.00	95-96			F 026 A02 586		
		2.8 D Turbo 4x4	10.97-02.00	95-96			F 026 A02 587		
		3.0 dCi 4x4, Di Hardtop 4x4, Di 4x4	02.00-03.10	116/118			F 026 A07 634		
		4.2 D	10.97→	107			F 026 A02 586		
		4.5 i	08.97→	147			F 026 A02 586		
		2.8 D Turbo 4x4	10.97-02.00	95-96			F 01G 065 02C		
		3.0 dCi 4x4	01.07-03.10	118			F 01G 065 02C		
		3.0 Di Hardtop 4x4	02.00-07.01	116			F 01G 065 02C		
			11.02-03.10	116			F 01G 065 02C		
		3.0 Di Hardtop 4x4, Di 4x4	08.01-10.02	116			F 01G 065 02D		
		3.0 Di 4x4	02.00-07.01	116			F 01G 065 02C		
			11.02-03.10	116			F 01G 065 02C		
		4.8	10.02-03.10	180-185			F 01G 065 02C		
Patrol [260]									
		2.8 D, D Turbo	05.91-05.98	57/70/80/85			0986 480 928	23,8	
		3.0	05.91-05.98	99			0986 480 928	23,8	
		2.8 D, D Turbo	04.91-05.98	57/70/80/85			0986 485 127		
		3.0	04.91-05.98	99			0986 485 127		
Pickup [D21]									
		2.0	09.85-09.95	64/65			F 01G 09C 0LP		
		2.4 i, i 4x4	04.92-02.98	91-93			F 01G 09C 0LP		
		2.5 D, D 4WD	08.87-02.98	59-63			F 01G 09C 0LP		
		2.7 D 2WD	08.87-01.97	62			F 01G 09C 0LP		
		2.7 D, D 4WD	08.87-01.97	73			F 01G 09C 0M1		
		2.0	03.92-09.95	65			F 026 A01 848		
		2.4 i 2WD	03.92-10.95	93			F 026 A01 866		
		2.4 i 4WD	11.95-01.97	93			F 026 A05 940		
		2.7 D 2WD	03.92-09.95	62			F 026 A01 848		
			11.95-01.97	62			F 026 A05 940		
		2.0	03.92-09.95	65			F 026 A06 573		
		2.4 i 2WD	03.92-10.95	93			F 026 A06 573		
			11.95-01.97	93			F 026 A02 599		
		2.4 i 4WD	10.95-01.97	93			F 026 A02 598		
		2.7 D 2WD	10.95-01.97	62			F 026 A02 597		





Pickup [D22]



	2.4 i	ABO	11.01-01.07	98		F 01G 09C 109	F 026 A07 977⁶
			02.07-01.08	98	TW	F 01G 062 087	F 01G 062 08S⁶
	2.4 i	ABO	02.98-11.01	88			F 026 A07 977⁶
	2.4 i 4WD	ABS	02.98-11.01	88		F 01G 062 0BK	F 01G 09C 15M⁶
	2.5 D Turbo	ABO	11.01-01.07	98	NOR,TW	F 01G 09C 109	F 026 A07 977⁶
			11.01-01.08	98	TW	F 01G 062 087	F 01G 062 08S⁶
	2.5 D, D Turbo 4WD, D 4WD	ABO	02.98-11.01	61/76			F 026 A07 977⁶
		ABS	02.98-11.01	61/76		F 01G 062 0BK	F 01G 09C 15M⁶
	2.5 dCi	ABO	02.08-12.11	98	LLE	F 01G 062 087	
					RLE BO	F 01G 062 085	F 01G 062 08S⁶
2.7 D 2WD		02.97→	64		F 026 A01 746	F 026 A07 977⁶	
3.2 D 4WD		02.97-12.07	76	LLE,TW	F 01G 062 086		
					F 01G 062 087		
					F 01G 062 089		
					RLE,TW	F 01G 062 084	
						F 01G 062 085	
						F 01G 062 088	
						F 026 A01 745	
						F 026 A01 746	
						F 026 A01 746	
						F 026 A01 746	F 026 A07 977⁶

	2.4 i		02.98-11.01	88	DOP	F 01G 09B 1EG	
		ABO	11.01-01.08	98		F 01G 061 0P8	
		ABS	11.01-01.08	98		F 01G 061 0LP	
	2.4 i 4WD		02.98-11.01	88		F 01G 09B 1EG	
			11.01-01.08	98		F 01G 061 0LP	
	2.5 D Turbo	ABO	11.01-12.06	98		F 01G 061 0P8	
			01.07-01.08	98		F 01G 061 0LH	
	2.5 D Turbo 4WD	ABS	11.01-01.08	98		F 01G 061 0LP	
			05.98-11.01	76		F 01G 09B 1EF	
	2.5 D Turbo 4WD		11.01-01.08	98		F 01G 061 0LP	
2.5 dCi	ABO	02.08-12.11	98	LLE	F 01G 061 0LH		
				RLE	F 01G 061 0LG		
	ABS	02.08-12.11	98	LLE	F 01G 061 0LP		
				RLE	F 01G 061 0LJ		
2.5 dCi 4x4		02.08-12.11	98		F 01G 061 0LP		
2.7 D 2WD		02.97→	64		F 01G 09B 13Z		
3.2 D 4WD		02.97→			F 01G 09B 13Z		
					F 01G 061 0LH		
					LLE,TW	F 01G 061 0LH	
						F 01G 061 0LP	
					RLE,TW	F 01G 061 0LG	
						F 01G 061 0LJ	
		ABO	07.99-09.01	76	LLE	F 01G 09B 19S	
						F 01G 09B 19W	
		ABS	07.99-09.01	76	LLE	F 01G 09B 19S	
						F 01G 09B 19W	
F 01G 09B 1EF							
F 01G 09B 24J							
		10.01-11.01	76	LLE	F 01G 09B 1EN		

	2.7 D 2WD		02.97→	64		F 026 A01 916	
--	------------------	--	--------	----	--	----------------------	--

















	2.5 D Turbo 4WD		05.98-11.01	76		F 026 A07 713	
	2.7 D 2WD		02.97→	64		F 026 A02 597	
	3.2 D 4WD		02.97→			F 026 A07 713	

	2.4 i		11.01-01.08	98		F 01G 09D 03P^B	
	2.4 i 4WD		11.01-01.08	98		F 01G 09D 03N^B	
	2.5 D Turbo		11.01-01.08	98	NOR	F 01G 09D 03P^B	
	2.5 D Turbo 4WD		11.01-01.08	98		F 01G 09D 03N^B	



		S							
NISSAN Pickup [D22]									
	2.5 dCi								
	2.5 dCi 4x4								
	3.2 D 4WD								
	2.4 i 4WD								
	2.5 D Turbo 4WD								
	2.5 dCi 4x4								
	3.2 D 4WD								
Prairie Pro [M11]									
	2.4 i								
	2.4 i 4WD								
Primastar [X83]									
	1.9 dCi 80	ABO	07.02-09.06	59-60/74		JBH	0986 480 887	20,6	
	1.9 dCi 100	ABS	07.02-09.03	59-60/74		JBH,TW	0986 480 831	25,4	
			07.02-09.06	59-60/74		JBH,TW	0986 480 827	25,4	
			10.03-09.06	59-60/74		JBH,TW	0986 480 999	20,64	
	2.0 i	ABO	02.03-09.06	86-88		JBH	0986 480 887	20,6	
		ABS	02.03-09.03	86-88		JBH,TW	0986 480 831	25,4	
			02.03-09.06	86-88		JBH,TW	0986 480 827	25,4	
			10.03-09.06	86-88		JBH,TW	0986 480 828	25,4	
	2.5 dCi 135	ABO	09.03-09.06	99		JBH	0986 480 887	20,6	
		ABS	09.03-09.06	99		JBH,TW	0986 480 827	25,4	
							0986 480 828	25,4	
							0986 480 831	25,4	
			10.03-11.11	99		JBH,TW	0986 480 999	20,64	
	2.5 dCi 150	ABS	10.06->	107-110		JBH,TW	0986 480 999	20,64	
	1.9 dCi 80, dCi 100		07.02-12.07	59-60/74		LLE	0986 486 147	15,87	
	2.0 dCi 90, dCi 115		10.06->	66/84-85			0986 486 147	15,87	
	2.0 i		02.03-11.11	86-88		LLE	0986 486 147	15,87	
	2.5 dCi 135, dCi 150		09.03->	99/107-110		LLE	0986 486 147	15,87	
Primera Hatchback [P10E]									
	1.6 i	ABO	05.93-09.94	71-75			0204 123 129	22,2	
		ABS	05.93-06.96	71-75			F 01G 09C OSK		F 01G 09C 15B ⁶
	2.0 D, i, i 4WD	ABS	06.90-06.96	55/85-92/110			F 01G 09C OSK		F 01G 09C 15B ⁶
	2.0 i, i 4WD	ABO	06.90-06.96	85-92/110		JBH	0986 480 695	23,8	
	1.6 i		05.93-06.96	71-75			0265 201 064 ^H		
	2.0 i, i 4WD		06.90-06.96	85-92/110			0265 201 064 ^H		
	2.0 i		06.90-06.96	110		RLE	0265 100 054 ^H		
Primera Hatchback [P11E]									
	1.6 i		06.96-06.97	66-73					F 01G 09C 15B
			06.99-12.01	73/78			0204 021 667		
	1.8 i		06.99-12.01	84			0204 021 667		



		S							
2.0D Turbo		06.96-06.97	66						F 01G 09C 15B
		07.99-12.01	66				0 204 021 667		
2.0i		06.96-06.97	85/96						F 01G 09C 15B
		06.99-12.01	103				0 204 021 667		
2.0i GT		06.96-06.97	110						F 01G 09C 15B
 1.6i	ABO	06.99-12.01	73/78				0 204 021 676		
	ABS	06.99-12.01	73/78				0 204 021 797		
1.8i	ABO	06.99-12.01	84				0 204 021 676		
	ABS	06.99-12.01	84				0 204 021 797		
2.0D Turbo		06.96-06.99	66				0 204 125 502		
	ABO	07.99-12.01	66				0 204 021 677		
	ABS	07.99-12.01	66				0 204 021 799		
2.0i		06.99-12.01	103				0 204 021 797		
 1.6i		09.00-12.01	78				F 026 A02 609		
1.8i		06.99-12.01	84				F 026 A02 609		
2.0i		06.99-12.01	103				F 026 A02 609		
 1.6i		05.98-05.99	66-73				0 265 216 587 ^H		
		06.99-07.00	73				0 265 216 587 ^H		
		05.01-12.01	73				0 265 216 898 ^H		
			78				0 265 216 898 ^H		
1.8i		06.99-07.00	84				0 265 216 587 ^H		
		05.01-12.01	84				0 265 216 898 ^H		
2.0D Turbo		05.98-07.00	66				0 265 216 587 ^H		
		06.01-12.01	66				0 265 216 898 ^H		
2.0i		05.98-06.99	96				0 265 216 587 ^H		
		06.99-07.00	103		AG		0 265 216 689 ^H		
					GS		0 265 216 587 ^H		
		05.01-12.01	103		GS		0 265 216 898 ^H		
2.0i GT		05.98-06.99	110				0 265 216 587 ^H		
Primera Hatchback [P12E]									
									
 1.8	MFD	09.04-07.10	85	Fg.-Nr. 212061→		GS,LLE	0 204 051 074		
		02.05-07.10	85	Fg.-Nr. 231587→		AG,LLE	0 204 055 390		
1.9D Turbo	MFD	09.04-07.10	85-88	Fg.-Nr. 212061→			0 204 051 074		
2.0	MFD	09.04-07.10	103	Fg.-Nr. 212061→		GS,LLE	0 204 051 074		
		02.05-07.10	103	Fg.-Nr. 231587→		AG,GS,LLE	0 204 055 390		
2.2D Turbo	MFD	09.04-09.10	93/100-102	Fg.-Nr. 212061→		LLE	0 204 051 074		
 1.8	MFD	09.04-07.10	85			GS,LLE	0 204 125 835		
		02.05-07.10	85			AG,LLE	0 204 125 835		
1.9D Turbo	MFD	09.04-07.10	85-88				0 204 125 835		
2.0	MFD	09.04-01.05	103			HOG,LLE	0 204 125 835		
		02.05-07.10	103			GBM,LLE	0 204 125 835		
2.2D Turbo	MFD	09.04-09.10	93/100-102			LLE	0 204 125 835		
 2.0		05.02-07.10	103				F 026 A02 594		
 1.6		05.02-06.10	78-80				0 265 231 318 ^H		
1.8		05.02-09.02	85			LLE	0 265 202 519 ^M		
						RLE	0 265 202 517 ^M		
		10.02-06.04	85				0 265 202 525 ^T		
		07.04-07.10	85			AG	0 265 234 147 ^T		
						GS	0 265 234 185 ^T		
	OFD	05.02-07.10	85				0 265 231 318 ^H		
1.9D Turbo		01.03-06.04	85-88				0 265 202 525 ^T		
		07.04-07.10	85-88				0 265 234 147 ^T		
	OFD	01.03-07.10	85-88				0 265 231 318 ^H		



		S									
NISSAN Primera Hatchback [P12E]											
	2.0	05.02-09.02	103				LLE,MNS	0 265	202 507^M		
							LLE, MNS	0 265	202 519^M		
		10.02-06.04	103					MNS,RLE	0 265	202 505^M	
								MNS ,RLE	0 265	202 517^M	
		07.04-07.10	103					LLE	0 265	202 525^T	
								RLE	0 265	202 507^M	
		OFD 05.02-07.10	103					RLE	0 265	202 505^M	
									0 265	234 147^T	
	2.2 D Turbo	05.02-09.02	93					LLE	0 265	202 519^M	
								RLE	0 265	202 517^M	
		05.02-08.10	93							0 265	231 318^H
										0 265	202 525^T
		10.02-06.04	93							0 265	202 525^T
										0 265	231 318^H
01.03-06.04		100-102							0 265	202 525^T	
									0 265	231 318^H	
01.03-09.10	100-102							0 265	231 318^H		
								0 265	234 147^T		
07.04-08.10	93							0 265	234 147^T		
								0 265	234 147^T		
07.04-09.10	100-102							0 265	234 147^T		
								0 265	234 147^T		
	1.8	05.02-06.04	85				AG	0 265	109 621^M		
							GS	0 265	109 620^M		
	1.9 D Turbo	01.03-06.03	85-88						0 265	109 624^M	
									0 265	109 750^M	
	07.03-06.04	85-88							0 265	109 750^M	
									0 265	109 604^M	
	2.0	05.02-06.04	103					AG	0 265	109 604^M	
								GS	0 265	109 605^M	
	2.2 D Turbo	05.02-06.04	93						0 265	109 622^M	
									0 265	109 623^M	
01.03-06.04	100-102							0 265	109 623^M		
								0 265	109 623^M		
	1.8	05.02-07.10	85					0 265	005 265		
	1.9 D Turbo	01.03-07.10	85-88					0 265	005 265		
	2.0	05.02-07.10	103					0 265	005 265		
	2.2 D Turbo	05.02-09.10	93/100-102					0 265	005 265		
	1.8	05.02-07.10	85					F 01G	09F 0MT		
	1.9 D Turbo	01.03-07.10	85-88					F 01G	09F 0MT		
	2.0	05.02-07.10	103					F 01G	09F 0MT		
	2.2 D Turbo	05.02-09.10	93/100-102					F 01G	09F 0MT		
Primera [P11E]											
	2.0 i	01.01→	103					0 204	021 667		
Primera [P12E]											
	1.8	MFD 09.04-06.10	85	Fg.-Nr. 212061→				GS,LLE	0 204	051 074	
								AG,LLE	0 204	055 390	
	1.9 D Turbo	MFD 09.04-07.10	85-88	Fg.-Nr. 212061→						0 204	051 074
										0 204	051 074
	2.0	MFD 09.04-07.10	103	Fg.-Nr. 212061→					GS,LLE	0 204	051 074
									AG, GS ,LLE	0 204	055 390
2.2 D Turbo	MFD 09.04-09.10	93/100-102	Fg.-Nr. 212061→					LLE	0 204	051 074	
									0 204	051 074	
	1.8	MFD 09.04-06.10	85					GS,LLE	0 204	125 835	
								AG,LLE	0 204	125 835	
	1.9 D Turbo	MFD 09.04-07.10	85-88							0 204	125 835
										0 204	125 835
	2.0	MFD 09.04-01.05	103						HOG,LLE	0 204	125 835
									GBM,LLE	0 204	125 835
2.2 D Turbo	MFD 09.04-09.10	93/100-102						LLE	0 204	125 835	
									0 204	125 835	
	2.0	12.01-07.10	103					F 026	A02 594		



	1.6	12.01-06.10	78-80			0 265 231 318 ^H		
	1.8	12.01-09.02	85		LLE	0 265 202 519 ^M		
					RLE	0 265 202 517 ^M		
		12.01-06.10	85				0 265 231 318 ^H	
		10.02-06.04	85				0 265 202 525 ^T	
		07.04-06.10	85		AG	0 265 234 147 ^T		
					GS	0 265 234 185 ^T		
	1.9D Turbo	01.03-06.04	85-88				0 265 202 525 ^T	
		01.03-07.10	85-88				0 265 231 318 ^H	
		07.04-07.10	85-88				0 265 234 147 ^T	
	2.0	12.01-09.02	103		LLE,MNS	0 265 202 507 ^M		
					LLE,MNS	0 265 202 519 ^M		
					MNS,RLE	0 265 202 505 ^M		
					MNS,RLE	0 265 202 517 ^M		
			10.02-06.04	103			0 265 202 525 ^T	
					LLE	0 265 202 507 ^M		
				RLE	0 265 202 505 ^M			
	07.04-07.10	103			0 265 234 147 ^T			
2.2D Turbo	OFD 12.01-07.10	103				0 265 231 318 ^H		
	12.01-09.02	93		LLE	0 265 202 519 ^M			
				RLE	0 265 202 517 ^M			
		12.01-08.10	93			0 265 231 318 ^H		
		10.02-06.04	93			0 265 202 525 ^T		
		01.03-06.04	100-102			0 265 202 525 ^T		
		01.03-09.10	100-102			0 265 231 318 ^H		
		07.04-08.10	93			0 265 234 147 ^T		
	07.04-09.10	100-102			0 265 234 147 ^T			

	1.8	12.01-06.04	85		AG	0 265 109 621 ^M	
					GS	0 265 109 620 ^M	
	1.9D Turbo	01.03-06.03	85-88			0 265 109 624 ^M	
		07.03-06.04	85-88			0 265 109 750 ^M	
	2.0	12.01-06.04	103		AG	0 265 109 604 ^M	
					GS	0 265 109 605 ^M	
2.2D Turbo	12.01-06.04	93			0 265 109 622 ^M		
	01.03-06.04	100-102			0 265 109 623 ^M		

	1.8	12.01-06.10	85			0 265 005 265	
	1.9D Turbo	01.03-07.10	85-88			0 265 005 265	
	2.0	12.01-07.10	103			0 265 005 265	
	2.2D Turbo	12.01-09.10	93/100-102			0 265 005 265	

	1.6	12.01-06.10	78-80			F 01G 09F OMT	
	1.8	12.01-06.10	85			F 01G 09F OMT	
	1.9D Turbo	01.03-07.10	85-88			F 01G 09F OMT	
	2.0	12.01-07.10	103			F 01G 09F OMT	
	2.2D Turbo	12.01-09.10	93/100-102			F 01G 09F OMT	

Primera Sedan [P10E]

	1.6i	ABO 05.93-09.94	71-75			0 204 123 129	22,2
		ABS 05.93-06.96	71-75			F 01G 09C 0SK	F 01G 09C 15B ⁶
	2.0D, i, i 4WD	ABS 06.90-06.96	55/85-92/110			F 01G 09C 0SK	F 01G 09C 15B ⁶
	2.0i, i 4WD	ABO 06.90-06.96	85-92/110		JBH	0 986 480 695	23,8

	1.6i	05.93-06.96	71-75			0 265 201 064 ^H	
	2.0i, i 4WD	06.90-06.96	85-92/110			0 265 201 064 ^H	

	2.0i	06.90-06.96	110		RLE	0 265 100 054 ^H	
--	-------------	-------------	-----	--	-----	-----------------------------------	--





◀ NISSAN

Primera Sedan [P11E]



	1.6 i	06.96-06.97	66-73				F 01G 09C 15B
		06.99-12.01	73/78			0 204 021 667	
1.8 i	06.99-12.01	84				0 204 021 667	
	2.0 D Turbo	06.96-06.97	66				F 01G 09C 15B
07.99-12.01		66				0 204 021 667	
2.0 i	06.96-06.97	85/96					F 01G 09C 15B
	06.99-12.01	103				0 204 021 667	
2.0 i GT	06.96-06.97	110					F 01G 09C 15B

	1.6 i	ABO 06.99-12.01	73/78			0 204 021 676	
		ABS 06.99-12.01	73/78			0 204 021 797	
1.8 i	ABO 06.99-12.01	84				0 204 021 676	
	ABS 06.99-12.01	84				0 204 021 797	
2.0 D Turbo	06.96-06.99	66				0 204 125 502	
	ABO 07.99-12.01	66				0 204 021 677	
	ABS 07.99-12.01	66				0 204 021 799	
2.0 i	06.99-12.01	103				0 204 021 797	

	1.6 i	09.00-12.01	78			F 026 A02 609	
	1.8 i	06.99-12.01	84			F 026 A02 609	
	2.0 i	06.99-12.01	103			F 026 A02 609	

	1.6 i	05.98-05.99	66-73			0 265 216 587 ^H	
		06.99-07.00	73			0 265 216 587 ^H	
		05.01-12.01	73			0 265 216 898 ^H	
			78			0 265 216 898 ^H	
1.8 i	06.99-07.00	84				0 265 216 587 ^H	
	05.01-12.01	84				0 265 216 898 ^H	
2.0 D Turbo	05.98-07.00	66				0 265 216 587 ^H	
	06.01-12.01	66				0 265 216 898 ^H	
2.0 i	05.98-06.99	96				0 265 216 587 ^H	
	06.99-07.00	103			AG	0 265 216 689 ^H	
						GS	0 265 216 587 ^H
	05.01-12.01	103			GS	0 265 216 898 ^H	
2.0 i GT	05.98-06.99	110				0 265 216 587 ^H	

Primera Wagon [P12E]

















	1.8	MFD 09.04-06.10	85	Fg.-Nr. 212061→	GS,LLE	0 204 051 074	
		02.05-06.10	85	Fg.-Nr. 231587→	AG,LLE	0 204 055 390	
1.9 D Turbo	MFD 09.04-07.10	85-88	Fg.-Nr. 212061→			0 204 051 074	
2.0	MFD 09.04-07.10	103	Fg.-Nr. 212061→	GS,LLE		0 204 051 074	
	02.05-07.10	103	Fg.-Nr. 231587→	AG,GES,LLE		0 204 055 390	
2.2 D Turbo	MFD 09.04-09.10	93/100-102	Fg.-Nr. 212061→	LLE		0 204 051 074	

	1.8	MFD 09.04-06.10	85		GS,LLE	0 204 125 835	
		02.05-06.10	85		AG,LLE	0 204 125 835	
1.9 D Turbo	MFD 09.04-07.10	85-88				0 204 125 835	
2.0	MFD 09.04-01.05	103			HOG,LLE	0 204 125 835	
	02.05-07.10	103			GBM,LLE	0 204 125 835	
2.2 D Turbo	MFD 09.04-09.10	93/100-102			LLE	0 204 125 835	

	2.0	12.01-07.10	103			F 026 A02 594	
--	-----	-------------	-----	--	--	---------------	--

	1.6	12.01-06.10	80			0 265 231 318 ^H	
--	-----	-------------	----	--	--	----------------------------	--

		S																
1.8							LLE	0 265 202 519 ^M										
							RLE	0 265 202 517 ^M										
							10.02-06.04	85		0 265 202 525 ^T								
							07.04-06.10	85	AG	0 265 234 147 ^T								
									GS	0 265 234 185 ^T								
							OFD	12.01-06.10	85		0 265 231 318 ^H							
							1.9D Turbo								0 265 202 525 ^T			
														01.03-06.04	85-88		0 265 234 147 ^T	
														07.04-07.10	85-88		0 265 231 318 ^H	
							OFD	01.03-07.10	85-88		0 265 231 318 ^H							
2.0							LLE,MNS	0 265 202 507 ^M										
							LLE,MNS	0 265 202 519 ^M										
							MNS,RLE	0 265 202 505 ^M										
							MNS,RLE	0 265 202 517 ^M										
							10.02-06.04	103		0 265 202 525 ^T								
									LLE	0 265 202 507 ^M								
									RLE	0 265 202 505 ^M								
							07.04-07.10	103		0 265 234 147 ^T								
							OFD	12.01-07.10	103		0 265 231 318 ^H							
							2.2D Turbo							LLE	0 265 202 519 ^M			
RLE	0 265 202 517 ^M																	
12.01-08.10	93		0 265 231 318 ^H															
10.02-06.04	93		0 265 202 525 ^T															
01.03-06.04	100-102		0 265 202 525 ^T															
01.03-09.10	100-102		0 265 231 318 ^H															
07.04-08.10	93		0 265 234 147 ^T															
07.04-09.10	100-102		0 265 234 147 ^T															
CPU														AG	0 265 109 621 ^M			
														GS	0 265 109 620 ^M			
							1.9D Turbo								0 265 109 624 ^M			
														01.03-06.03	85-88		0 265 109 750 ^M	
															0 265 109 604 ^M			
							2.0							AG	0 265 109 604 ^M			
														12.01-06.04	103	GS	0 265 109 605 ^M	
							2.2D Turbo								0 265 109 622 ^M			
														12.01-06.04	93		0 265 109 623 ^M	
															0 265 109 623 ^M			
								0 265 005 265										
							1.8	12.01-06.10	85		0 265 005 265							
							1.9D Turbo	01.03-07.10	85-88		0 265 005 265							
							2.0	12.01-07.10	103		0 265 005 265							
2.2D Turbo	12.01-09.10	93/100-102		0 265 005 265														
								F 01G 09F OMT										
							1.8	12.01-06.10	85		F 01G 09F OMT							
							1.9D Turbo	01.03-07.10	85-88		F 01G 09F OMT							
							2.0	12.01-07.10	103		F 01G 09F OMT							
2.2D Turbo	12.01-09.10	93/100-102		F 01G 09F OMT														
Primera Wagon [WP11E]																		
																		
								0 204 021 667										
							1.6 i	06.99-12.01	73		0 204 021 667							
							1.8 i	06.99-12.01	84		0 204 021 667							
2.0D Turbo, i	06.99-12.01	66/103		0 204 021 667														
								0 204 021 797										
							1.6 i	06.99-12.01	73		0 204 021 797							
							1.8 i	06.99-12.01	84		0 204 125 502							
							2.0D Turbo								0 204 021 799			
														01.98-06.99	66		0 204 021 797	
07.99-12.01	66		0 204 021 797															
2.0 i	06.99-12.01	103		0 204 021 797														
								F 026 A02 609										
							1.8 i	06.99-12.01	84		F 026 A02 609							
2.0 i	06.99-12.01	103		F 026 A02 609														



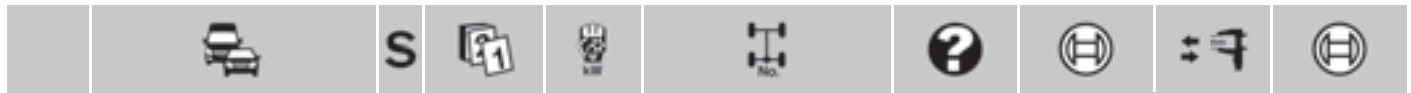

◀ NISSAN Primera Wagon [WP11E]

	1.6 i	01.98-06.99	66		0 265 216 587 ^H	
		01.98-06.00	73		0 265 216 587 ^H	
		05.01-12.01	73		0 265 216 898 ^H	
	1.8 i	06.99-06.00	84		0 265 216 587 ^H	
		05.01-12.01	84		0 265 216 898 ^H	
	2.0 D Turbo	01.98-06.00	66		0 265 216 587 ^H	
		05.01-12.01	66		0 265 216 898 ^H	
	2.0 i	01.98-06.99	85/96		0 265 216 587 ^H	
		06.99-07.00	103	AG	0 265 216 689 ^H	
				GS	0 265 216 587 ^H	
		05.01-12.01	103	GS	0 265 216 898 ^H	

Primera Wagon [W10]

	2.0 D	07.90-04.96	55/85/89	JBH	0 986 480 959	23,8
	2.0 i	ABS	07.90-07.94	85/89	F 01G 09B 143	
	2.0 i	07.90-07.94	85/89		0 265 201 065 ^H	

Pulsar

	1.5 i	08.95-02.98	77	TW	F 01G 09C 0TN					
					1.5 i 4WD	02.98-10.99	77	TW	F 026 A01 718	
									F 026 A07 608	
	1.5 i	08.95-10.99	77	TW	F 01G 09B 0XG					
					1.5 i 4WD	F 01G 09B 13M				
	1.5 i	08.95-02.98	77		F 01G 09D 043 ^H					
				1.5 i 4WD						

Pulsar Hatchback [N14]

	2.0 i	A0	08.91-05.95	105	F 026 A07 601	
		ABS	08.91-05.95	105	F 026 A01 691	
	2.0 i		08.91-05.95	105	F 01G 09B 14A	
	2.0 i		08.91-05.95	105	F 01G 09D 005 ^H	

Pulsar Hatchback [N15]

	1.6		02.98-06.00	86	TW	F 026 A01 718	
		ABS	08.95-01.98	86		F 01G 09C 0TN	F 01G 09C 159 ⁶
		1.6 i	ABS	10.95-03.98	86		F 026 A07 607
	04.98-10.99		86	ACO	F 026 A07 608		
				TOO	F 026 A01 718		
	2.0 i		03.98-06.00	105		F 01G 09C 15A ⁶	
		A0	08.95-02.98	105		F 01G 09C 155 ⁶	
		ABS	08.95-02.98	105		F 01G 09C 15A ⁶	
			10.95-06.00	105		F 026 A07 609	

		S							
	1.6	08.95-06.00	86				F 01G 09B 13M		
	2.0i	02.98-06.00	105				F 01G 09B 19C		
	1.6	08.95-02.98	86				F 01G 09D 043^H		
	2.0i	08.95-02.98	105				F 01G 09D 043^H		
	1.6	08.95-07.97	86				0 265 108 010^H		
	2.0i	08.95-07.97	105				0 265 108 010^H		
Pulsar [N14]									
	1.6	08.91-05.95	86		4SB		F 026 A01 689		
	1.6i	03.93-05.95	86		STB	ACO	F 026 A01 662		
						TOO	F 026 A01 661		
					4SB		F 026 A07 600		
	1.6	08.91-05.95	86		STB		F 01G 09B 14A		
	1.6i								
Pulsar [N16]									
	1.3	12.99-07.09	65		TW		F 01G 062 0AE		
							F 01G 062 091		
							F 01G 09C 0UX		
	1.6i	ABO 07.00-02.03	83				F 026 A01 739		
	1.8L	ABO 07.00-02.03	92				F 026 A01 739		
	1.3	12.99-07.09	65				F 01G 061 0PC		
	1.6i	07.00-02.03	83				F 026 A02 609		
	1.3	12.99-10.00	65				F 01G 09D 05R^T		
		10.03-07.09	65				F 01G 09D 06G^T		
Pulsar Sedan [N15]									
	1.6	02.98-06.00	81-86		SLX,TW		F 026 A01 718		
		ABS 08.95-01.98	81-86				F 01G 09C 0TN		F 01G 09C 159⁶
	1.6	08.95-06.00	81-86				F 01G 09B 13M		
	1.6	08.95-02.98	81-86				F 01G 09D 043^H		
	1.6	08.95-07.97	81-86				0 265 108 010^H		
Qashqai [J10]									
	1.5 dCi	MFD 12.06-04.09	76-78		LLE		0 986 481 064	23,8	
					RLE		0 204 054 627	23,81	
		OFD 12.06-04.09	76-78		LLE		0 204 054 630	23,81	
		12.06-12.09	76-78		RLE		0 204 054 629	23,81	



		S									
NISSAN Qashqai [J10]											
	1.6	MFD	12.06-04.09	84-89			LLE	0986	481 064	23,8	
							RLE	0204	054 627	23,81	
		OFD	12.06-04.09	84-89				LLE	0204	054 630	23,81
								RLE	0204	054 629	23,81
		OFD	12.06-04.09	103-106				LLE	0204	054 630	23,81
								RLE	0204	054 629	23,81
	2.0			05.09-12.09	103-106			GS,RLE	0204	054 629	23,81
	2.0, dCi, dCi 4x4, 4x4	MFD	12.06-04.09	103-106/ 110				LLE	0986	481 064	23,8
								RLE	0204	054 627	23,81
2.0 dCi	OFD	04.07-04.09	110				LLE	0204	054 630	23,81	
2.0 dCi 4x4							RLE	0204	054 629	23,81	
2.0 4x4	OFD	12.06-04.09	103-104				LLE	0204	054 630	23,81	
							RLE	0204	054 629	23,81	
	1.5 dCi		12.06→	76-78/81			LLE	0204	051 552		
							RLE	0204	051 551		
	1.6		12.06→	84-89				LLE	0204	051 552	
								RLE	0204	051 551	
								LLE,SSJ	0204	769 754	
								LLE,SSJ	0204	051 552	
			11.10→	86				RLE,SSJ	0204	769 753	
								RLE,SSJ	0204	051 551	
	1.6 dCi		07.11→	96				LLE	0204	769 754	
	1.6 dCi 4x4							RLE	0204	769 753	
2.0		12.06→	103-106				LLE	0204	051 552		
2.0 4x4							RLE	0204	051 551		
2.0 dCi		04.07→	110				LLE	0204	769 754		
2.0 dCi 4x4		04.07→	110				RLE	0204	051 551		
							LLE	0204	051 552		
2.0 4x4		04.07→	110				LLE	0204	051 552		
							RLE	0204	051 551		
	1.5 dCi		12.06→	76-78/81				0265	231 900^B		
	1.6		12.06-08.09	84-89				LLE	0265	230 697^T	
			12.06→	84-89					0265	231 900^B	
			11.10→	86				SSJ	0265	231 900^B	
	2.0		12.06→	103-106					0265	231 900^B	
2.0 dCi		04.07→	110					0265	231 900^B		
2.0 dCi 4x4		04.07→	110					0265	231 902^B		
2.0 4x4		12.06→	103-104					0265	231 902^B		
Qashqai [J11E]											
	1.2 DIG-Ti		12.13-06.14	85					0204	830 141	
			07.14→	85				CVT	0204	830 142	
								GS	0204	830 141	
	1.5 DCi		12.13→	81					0204	830 141	
	1.6 DCi		12.13→	96				CVT	0204	830 142	
								GS	0204	830 141	
	1.6 DCi 4x4		12.13→	96					0204	830 141	
	1.6 DiG-Ti 4x2		10.14→	120					0204	830 141	
	2.0		12.13→	102				CVT	0204	830 142	
GS								0204	830 141		
	1.2 DIG-Ti		12.13→	85					0204	815 532	
	1.5 DCi		12.13→	81					0204	815 532	
	1.6 DCi, DCi 4x4, DiG-Ti 4x2		12.13→	96/120					0204	815 532	
	2.0		12.13→	102					0204	815 532	

		S							
Qashqai+2 [JJ10]									
	1.5 dCi	08.08→	78/81			LLE	0 204 051 552		
						RLE	0 204 051 551		
	1.6	08.08→	84			LLE	0 204 051 552		
						RLE	0 204 051 551		
		11.10→	86			LLE,SSJ	0 204 769 754		
						LLE,SSJ	0 204 051 552		
					RLE,SSJ	0 204 769 753			
					RLE,SSJ	0 204 051 551			
	1.6 dCi	07.11→	96			LLE	0 204 769 754		
	1.6 dCi 4x4					RLE	0 204 769 753		
	2.0, dCi, dCi 4x4, 4x4	08.08→	104/110			LLE	0 204 051 552		
						RLE	0 204 051 551		
	2.0 dCi 4x4	08.08→	104/110				0 265 232 221 ^B		
	2.0 4x4								
Safari									
	4.5	08.97→	147			TW	F 01G 061 0LR		
							F 01G 061 0LT		
	4.5	08.97→	147				F 026 A06 900		
	4.5	08.97→	147				F 026 A02 586		
	4.5	08.97-09.01	147				F 01G 065 02C		
		10.01→	147				F 01G 065 02D		
Sentra									
	1.4	05.92-06.97	63						F 01G 09C 16W ⁶
	1.4	10.92-06.97	63				F 01G 09B 13K		
		ABO 05.92-06.97	63				F 01G 09B 12A		
		ABO 05.92-06.97	73/79				F 01G 09B 12A		
Serena [C23M]									
	2.0i	07.92-11.01	93-96				F 01G 09D 01N ^H		
Sunny									
	1.6i	12.94→	88			TW	F 01G 09C 0ZS		
		07.97→	88			TW	F 01G 09C 0UX		
	1.6i	01.94→	88			TW	F 01G 09B 0XG		
		01.94-07.97	56				F 01G 09B 13M		
		08.97-09.99	56				F 01G 09B 195		



		S							
◀ NISSAN									
Sunny Hatchback [N14]									
	1.4	ABO	10.92-05.95	58-64			0986 480 945	20,6	F 026 A03 406 ⁶
	1.4i	ABS	10.92-05.95	58-64			F 01G 09C 0SP		F 01G 09C 158 ⁶
	1.6	ABO	10.92-05.95	70/75-81			0986 480 945	20,6	F 026 A03 406 ⁶
	1.6i	ABS	10.92-05.95	70/75-81			F 01G 09C 0SP		F 01G 09C 158 ⁶
	2.0D	ABO	10.90-05.95	55			0986 480 945	20,6	F 026 A03 406 ⁶
		ABS	10.92-05.95	55			F 01G 09C 0SP		F 01G 09C 158 ⁶
	2.0i		10.90-05.94	105					F 01G 09C 159 ⁶
			06.94-09.94	105			F 01G 09C 1FM		F 01G 09C 159 ⁶
	1.4,i		10.92-05.95	58-64			F 01G 09B 13K		
	1.6,i		10.92-05.95	70/75-81			F 01G 09B 13K		
	2.0D		10.92-05.95	55			F 01G 09B 13K		
	1.4,i		10.92-05.95	58-64			F 01G 09E 02Y ^H		
	1.6,i		10.92-05.95	70/75-81			F 01G 09E 02Y ^H		
	2.0D		10.92-05.95	55			F 01G 09E 02Y ^H		
	2.0i		10.90-09.94	105			F 01G 09E 02Y ^H		
Sunny Neo [N16]									
	1.6 i	ABO, ABS	10.00→	81			F 01G 062 0AA		
	1.6 i	ABS	09.03→	81			F 01G 09B 1EB		
	1.6 i		10.00-08.01	81			F 026 A01 913		
			09.01→	81			F 026 A05 944		
	1.6 i		10.00→	81			F 026 A02 609		
Sunny Sedan [N14]									
	1.4	ABO	10.92-05.95	58-64			0986 480 945	20,6	F 026 A03 406 ⁶
	1.4i	ABS	10.92-05.95	58-64			F 01G 09C 0SP		F 01G 09C 158 ⁶
	1.6	ABO	10.92-05.95	70			0986 480 945	20,6	F 026 A03 406 ⁶
	1.6, i, i 4WD, 4WD	ABS	10.90-10.95	66/70/75-81			F 01G 09C 0SP		F 01G 09C 158 ⁶
	1.6i	ABO	10.92-05.95	75-81			0986 480 945	20,6	F 026 A03 406 ⁶
	1.6 i 4WD	ABO	10.92-05.95	75-81					F 026 A03 406 ⁶
	1.6 4WD	ABO	10.90-10.95	66					F 026 A03 406 ⁶
	2.0D	ABO	10.90-05.95	55			0986 480 945	20,6	F 026 A03 406 ⁶
		ABS	10.92-05.95	55			F 01G 09C 0SP		F 01G 09C 158 ⁶
	1.4,i		10.92-05.95	58-64			F 01G 09B 13K		
	1.6, i, i 4WD		10.92-05.95	70/75-81			F 01G 09B 13K		
	2.0D		10.92-05.95	55			F 01G 09B 13K		
	1.4,i		10.92-05.95	58-64			F 01G 09E 02Y ^H		
	1.6,i		10.92-05.95	70/75-81			F 01G 09E 02Y ^H		
	2.0D		10.92-05.95	55			F 01G 09E 02Y ^H		
Teana									
	2.3i		02.03-06.08	127		TW	F 01G 09C 12E		



		S							
	2.3i	02.03-06.08	127			TW	F 01G 09B 1EV F 01G 09B 1EW		
	2.5i	06.08→	136			TW	0 265 230 323 ^T		
	2.5i	06.08→	136				0 265 005 806		
	2.3i	02.03-06.08	127				F 01G 09F OMT		
Teana [J31]									
	2.0	04.06-02.08	100				F 01G 09C 131		F 01G 09C 17A ⁶
	2.3	04.06-02.08	127			LUX	F 01G 062 06J		F 01G 09C 16P ⁶
						LUX	F 01G 09C 131		F 01G 09C 17A ⁶
	3.5	07.06-02.08	180				F 01G 062 06J		F 01G 09C 16P ⁶
	2.0	04.06-02.08	100				F 01G 061 0GS		
	2.3	04.06-02.08	127				F 01G 061 0GS		
	3.5	07.06-02.08	180				F 01G 061 0GT		
	2.3	04.06-02.08	127				F 01G 09F OMT		
	3.5	07.06-02.08	180				F 01G 09F OMT		
Teana [J32]									
	2.5	MFD 02.08→	132-136				0 204 053 075		
		OFD 02.08→	132-136				0 204 053 074		
	3.5	02.08→	180-185				0 204 053 075		
	2.5	02.08→	132-136			TW	0 265 230 323 ^T		
	3.5	02.08→	180-185			TW	0 265 230 324 ^T		
	2.5	02.08→	132-136				0 265 005 806		
	3.5	02.08→	180-185				0 265 005 806		
Teana [J32R]									
	2.5	MFD 06.09→	134				0 204 053 075		
		OFD 06.09→	134				0 204 053 074		
	2.5 4x4	03.10→	123				0 204 053 075		
	3.5	06.09→	183				0 204 053 075		
	3.5	06.09→	183				0 265 230 324 ^T		
	2.5, 4x4	06.09→	123/134				0 265 005 806		
	3.5	06.09→	183				0 265 005 806		
Terrano II [R20]									
	2.4i 4x4	02.93-05.96	91				0 986 480 952	23,8	
		05.96-07.98	87			TW	0 986 480 952	23,8	
		ABS 05.96-10.99	87			JBH, TW	0 986 480 860		
		11.96-12.99	85			JBH	0 986 480 860		















		S							
NISSAN Terrano II [R20]									
	2.7 D Turbo 4x4	02.93-05.96	74					0 986 480 952	23,8
		01.96-05.96	91-92					0 986 480 952	23,8
		07.98-10.99	91-92			AG,JBH		0 986 480 860	
		11.98->	92			JBH		0 986 480 860	
		ABS 06.96-10.99	91-92			GS,JBH		0 986 480 860	
		11.96->	92			JBH		0 986 480 860	
	2.7 D Turbo 4x4	11.96->	92				F 026 A02 597		
	2.4 i 4x4	11.97-10.99	87				0 265 215 437^H		
		11.99-12.06	87				0 265 215 458^B		
	2.7 D Turbo 4x4	11.97-10.99	91-92				0 265 215 437^H		
		11.98-12.99	92				0 265 215 437^H		
		11.98->	92				0 265 215 458^B		
		10.99-02.02	74				0 265 215 458^B		
		11.99-12.06	91-92				0 265 215 458^B		
		3.0 D Turbo 4x4	02.02-12.06	113				0 265 215 458^B	
Trade									
	2.8 D	03.87-12.98	57-60				0 204 162 048		
	2.8 D	03.87-12.98	57-60				0 204 163 055		
	2.0 D	03.87-12.98	41/46				0 204 131 142^A		
	2.8 D	03.87-12.98	57-60				0 204 131 142^A		
	3.0 D, D Turbo	04.93-12.98	63/78				0 204 131 142^A		
Urvan [E24]									
	2.4	11.86-06.97	74		TW		F 01G 09C ONM	F 026 A07 977⁶	
		10.92-06.97	74		TW		F 01G 09C OPG	F 01G 09C 14E⁶	
	2.4 i	05.89-11.95	74-76				F 01G 09C ONN		
	2.5 D	12.88-05.97	59				F 01G 09C ONN		
	2.7 D	11.86-06.97	62		TW		F 01G 09C ONM	F 026 A07 977⁶	
		02.87-06.97	62		TW		F 01G 09C ONL	F 026 A07 977⁶	
		10.92-06.97	62		TW		F 01G 09C OPG	F 01G 09C 14E⁶	
	2.7 D	11.86-06.97	62				F 026 A01 838		
	2.4	11.86-06.97	74				F 026 A02 489		
		2.7 D	04.89-06.97	62				F 026 A02 541	
Vanette [C23]									
	2.0	05.92-09.94			TW		F 01G 09C 0YF		
	2.0	05.92-09.94					F 01G 09B 174		



		S							
Vanette [C220]									
	2.0D	10.90-11.94	44/47-49				0 986 480 686	23,8	
Xterra [N50]									
	4.0 4x4	01.13→	195-198				F 01G 09F 0MT		
X-Trail									
	2.0	08.07→	101		LLE		0 204 023 865		
	2.0i 4WD	10.00-09.03	110				F 026 A05 909		F 01G 09C 165 ⁶
		10.03-12.06	110				F 01G 09C 12U		F 01G 09C 17E ⁶
		01.07-08.07	110				F 01G 062 07K		F 01G 062 08T ⁶
	2.0i 4WD	10.00-08.05	110				F 01G 09B 1FC		
		09.05-08.07	110				F 01G 061 0LK		
	2.0i 4WD	10.00-08.07	110				F 026 A02 594		
X-Trail [T30]									
	2.0i 4x4	11.01→	103		AG		F 01G 09C 0WW		F 01G 09C 165 ⁶
					GS		F 026 A05 909		F 01G 09C 165 ⁶
	2.0 4x2	02.05-12.06	103		LLE		F 01G 062 07H		F 01G 09C 17E ⁶
		01.07-03.07	103		RLE		F 01G 09C 12U		F 01G 09C 17E ⁶
					LLE		F 01G 062 07H		F 01G 062 08T ⁶
					RLE		F 01G 062 07K		F 01G 062 08T ⁶
	2.0 4x4	06.01-01.03	103		GS,LLE,TW				F 01G 09C 167 ⁶
		06.01-09.03	103		AG,LLE				F 01G 09C 165 ⁶
					AG,RLE		F 01G 09C 0WW		F 01G 09C 165 ⁶
					GS,LLE,TW				F 01G 09C 16M ⁶
		10.03-12.06	103		AG,RLE		F 01G 09C 12T		F 01G 09C 17E ⁶
					GS,RLE		F 01G 09C 12U		F 01G 09C 17E ⁶
		10.03-03.07	103		AG,LLE		F 01G 062 07J		F 01G 09C 17E ⁶
					GS,LLE		F 01G 062 07H		F 01G 09C 17E ⁶
		01.07-03.07	103		AG,RLE		F 01G 062 07L		F 01G 062 08T ⁶
					GS,RLE		F 01G 062 07K		F 01G 062 08T ⁶
		MFD 06.01-01.03	103		GS,RLE				F 01G 09C 167 ⁶
		02.03-09.03	103		GS,RLE				F 01G 09C 16M ⁶
		OFD 06.01-09.03	103		GS,RLE		F 026 A05 909		F 01G 09C 165 ⁶
	2.2 D Turbo 4x2	02.05-09.05	100		LLE		F 01G 062 07H		F 01G 09C 17E ⁶
		02.05-10.05	100		RLE		F 01G 09C 12U		F 01G 09C 17E ⁶
		MFD 10.05-03.07	100		LLE				F 01G 09C 16M ⁶
		11.05-03.07	100		RLE				F 01G 09C 16M ⁶
		OFD 10.05-03.07	100		LLE		F 01G 062 07H		F 01G 09C 17E ⁶
		11.05-12.06	100		RLE		F 01G 09C 12U		F 01G 09C 17E ⁶
	2.2 D Turbo 4x2, D Turbo 4x4	OFD 01.07-03.07	100		RLE		F 01G 062 07K		F 01G 062 08T ⁶
	2.2 D Turbo 4x4	MFD 09.02-01.03	84		LLE				F 01G 09C 167 ⁶
					RLE				F 01G 09C 167 ⁶
		02.03-08.06	84		LLE				F 01G 09C 16M ⁶
					RLE				F 01G 09C 16M ⁶
		09.03-03.07	100		LLE				F 01G 09C 16M ⁶
					RLE				F 01G 09C 16M ⁶



													
NISSAN X-Trail [T30]													
2.2 D Turbo 4x4	OFD	06.01-08.06	84		LLE			F 01G 09C 165 ⁶					
								RLE	F 026 A05 909	F 01G 09C 165 ⁶			
		09.03-12.06	100		RLE	F 01G 09C 12U		F 01G 09C 17E ⁶					
		09.03-03.07	100		LLE	F 01G 062 07H		F 01G 09C 17E ⁶					
2.5		12.06→	121			F 01G 062 07J		F 01G 062 08T ⁶					
2.5 4x4	OFD	09.02-09.03	121		AG,LLE			F 01G 09C 165 ⁶					
					AG,RLE	F 01G 09C 0WW	F 01G 09C 165 ⁶						
					GS,LLE		F 01G 09C 165 ⁶						
					GS,RLE	F 026 A05 909	F 01G 09C 165 ⁶						
							F 01G 09C 17E ⁶						
					12.04-10.05	121	GS,RLE,SP	F 01G 09C 12U	F 01G 09C 17E ⁶				
					MFD	10.03-04.04	121	AG,LLE		F 01G 09C 165 ⁶			
						10.03-10.05	121	GS,LLE		F 01G 09C 17E ⁶			
						10.03-03.07	121	AG,RLE		F 01G 09C 16M ⁶			
								GS,RLE		F 01G 09C 16M ⁶			
						05.04-03.07	121	AG,LLE		F 01G 09C 16M ⁶			
						11.05-03.07	121	GS,LLE		F 01G 09C 16M ⁶			
						OFD	10.03-12.06	121	AG,RLE	F 01G 09C 12T	F 01G 09C 17E ⁶		
				GS,RLE	F 01G 09C 12U	F 01G 09C 17E ⁶							
		10.03-03.07	121	AG,LLE	F 01G 062 07J	F 01G 09C 17E ⁶							
				GS,LLE	F 01G 062 07H	F 01G 09C 17E ⁶							
		01.07-03.07	121	AG,RLE	F 01G 062 07L	F 01G 062 08T ⁶							
				GS,RLE	F 01G 062 07K	F 01G 062 08T ⁶							
								F 01G 09B 1FC					
								2.0 4x2	02.05-09.05	103		F 01G 09B 1FC	
								2.0 4x2, 4x4	10.05-03.07	103		F 01G 061 0LK	
								2.0 4x4	10.03-09.05	103		F 01G 09B 1FC	
									MFD	06.01-01.03	103	TW	F 01G 09B 1FD
													F 01G 09B 1FF
										02.03-09.03	103		F 01G 09B 1FF
									OFD	06.01-09.03	103		F 01G 09B 1FC
								2.2 D Turbo 4x2	MFD	09.03-09.05	100		F 01G 09B 1FF
								2.2 D Turbo 4x4		10.05-01.07	100		F 01G 061 0MY
										02.07-03.07	100		F 01G 061 0R7
									OFD	09.03-09.05	100		F 01G 09B 1FC
										10.05-03.07	100		F 01G 061 0LK
2.2 D Turbo 4x4	MFD	09.02-01.03	84		F 01G 09B 1FD								
		02.03-08.06	84		F 01G 09B 1FF								
		OFD	06.01-08.06	84		F 01G 09B 1FC							
2.5		12.06→	121		F 01G 061 0LK								
2.5 4x4	MFD	09.03-04.04	121		AG	F 01G 09B 1FF							
					GS	F 01G 09B 1FE							
						F 01G 09B 1FF							
						F 01G 061 0MY							
						F 01G 061 0R7							
						F 01G 09B 1FC							
						F 01G 09B 1FC							
						F 01G 061 0LK							
						OFD	09.03-10.05	121		F 01G 09B 1FC			
							11.05-03.07	121		F 01G 061 0LK			
					RLE	F 026 A05 944							
					2.2 D Turbo 4x4	06.01-08.06	84	RLE	F 026 A05 944				
					2.5 4x4	09.02-09.03	121	LUX,RLE	F 026 A05 944				
							F 026 A02 594						
							2.5 4x4	09.02-03.07	121		F 026 A02 594		
					GS,RLE	F 01G 09D 0AL ^M							
						LLE	F 01G 09D 0AM ^M						
					2.2 D Turbo 4x2	11.05-03.07	100	LLE	F 01G 09D 0AM ^M				
					2.2 D Turbo 4x2, D Turbo 4x4	01.07-03.07	100	RLE	F 01G 09D 0AV ^M				
					2.2 D Turbo 4x4		09.02-08.06	84	LLE	F 01G 09D 0AM ^M			
	09.03-10.05	100	LLE	F 01G 09D 0AM ^M									

		S							
	2.5 4x4	10.03-10.05	121		LLE	F 01G 09D 0AM ^M			
		01.07-03.07	121		RLE	F 01G 09D 0AV ^M			
	2.0 4x4	06.01-05.02	103		GS	F 01G 09E 02L ^M			
		06.02-09.03	103		GS	0 265 109 741 ^M			
	2.5 4x4	10.03-03.04	121		AG,RLE	F 01G 09E 02T ^M			
					GS,LLE	F 01G 09E 02V ^M			
	2.0 4x4	10.02-09.03	103			F 01G 09F 0MT			
	2.2 D Turbo 4x2, D Turbo 4x4	09.02-03.07	84/100			F 01G 09F 0MT			
	2.5 4x4	09.03-03.07	121			F 01G 09F 0MT			
X-Trail [T31]									
	2.0	04.07-07.10	104-106		LLE	0 204 023 863			
	2.0 dCi	MFD 04.07→	110		LLE	0 204 023 862			
		OFD 04.07→	110		LLE	0 204 023 863			
	2.0 dCi 4x4	MFD 04.07→	110		AG,LLE	0 204 023 864			
					GS,LLE	0 204 023 862			
			127		LLE	0 204 023 862			
		OFD 04.07→	110		AG,LLE	0 204 023 865			
					GS,LLE	0 204 023 863			
			127		LLE	0 204 023 863			
	2.0 4x4	MFD 04.07→	104		CVT,LLE	0 204 023 864			
					GS,LLE	0 204 023 862			
		OFD 04.07→	104		CVT,LLE	0 204 023 865			
					GS,LLE	0 204 023 863			
	2.5 4x4	07.10→	124		LLE	0 204 023 864			
		MFD 04.07-06.10	124		CVT,LLE	0 204 023 864			
					GS,LLE	0 204 023 862			
		OFD 04.07-06.10	124		CVT,LLE	0 204 023 865			
					GS,LLE	0 204 023 863			
X-Trail [T31R]									
	2.0 dCi 4x4	02.10→	110		AG	0 204 023 864			
					GS	0 204 023 862			
			127			0 204 023 862			
	2.0 4x4	MFD 10.09→	104		CVT	0 204 023 864			
					GS	0 204 023 862			
		OFD 10.09→	104		CVT	0 204 023 865			
					GS	0 204 023 863			
	2.5 4x4	10.09-11.10	124		CVT	0 204 023 864			
					GS	0 204 023 862			
		12.10→	124			0 204 023 864			
X-Trail [T32R]									
	1.6 DCi 4WD	12.14→	96			0 204 830 141			
	2.0 2WD	12.14→	106		CVT	0 204 830 142			
	2.0 4WD				GS	0 204 830 141			
	2.5 4WD	12.14→	126			0 204 830 142			
	1.6 DCi 4WD	12.14→	96			0 204 815 532			
	2.0 2WD, 4WD	12.14→	106			0 204 815 532			
	2.5 4WD	12.14→	126			0 204 815 532			



		S				?			
◀ NISSAN									
100 NX [B13]									
	1.6 i	ABO	10.92-10.94	75-81				F 01G 09B 12A	
		ABS	10.92-10.94	75-81				F 01G 09B 13K	
300 ZX [Z32]									
	3.0 i		01.90-11.95	168					F 01G 09C 157 ⁶
	3.0 i		02.94-11.95	168				F 01G 09B 0UB	
350 Z Cabriolet [Z33]									
	3.5		06.02-01.07	206-222		TW		F 01G 062 09D	
			09.06-04.09	230					F 01G 09C 16T
	3.5		09.03-01.07	206-222				F 01G 061 098	
	3.5		06.02-08.05	206		TW		F 01G 09D 0AR ^M	
			09.03-04.09	206-222/ 230		LLE		F 01G 09D 0AR ^M	
						RLE		F 01G 09D 0AK ^M	
	3.5		06.02-04.09	206-222/ 230				F 01G 09F 0MT	
350 Z Coupé [Z33]									
	3.5		09.02-04.09	206-222/ 230					F 01G 09C 16T
	3.5		09.02-01.07	206-222				F 01G 09B 1D8	
	3.5		09.02-04.09	206-222/ 230		LLE		F 01G 09D 0AR ^M	
						RLE		F 01G 09D 0AK ^M	
	3.5		09.02-01.07	206-222				F 01G 09F 0MT	
350 Z [Z33]									
	3.5		12.03→	206				F 01G 09C 18U	F 01G 09C 19E ⁷
	3.5		12.03→	206				F 01G 09B 1D8	
	3.5		12.03→	206				F 01G 09D 0AK ^H	





370 Z Coupé [Z34]

	3.7	10.08→ 04.09-02.13	241-243 241-243	TW LLE RLE	0 204 023 644 0 204 023 644 0 204 023 643	
		03.13→	241-243	LLE,TW RLE,TW	0 204 023 644 0 204 023 643	
	3.7	04.09-11.09 12.09→	241-243 241-243	RLE RLE	0 204 053 269 0 204 719 168	
	3.7	10.08→	241-243	TW	0 265 251 005 ^T 0 265 251 007 ^T	
	3.7	10.08→ 04.09→	241-243 241-243	TW	0 265 005 806 0 265 005 806	
	3.7	04.09-05.11	241-243		0 265 005 546	

370 Z Roadster [Z34]

	3.7	11.09→	241	LLE RLE	0 204 023 644 0 204 023 643	
	3.7	11.09→	241	RLE	0 204 719 169	
	3.7	11.09→	241	TW	0 265 005 806 0 265 005 858	
	3.7	11.09-05.11	241		0 265 005 546	

370Z Coupé [Z34]

	3.7 Nismo	03.13→	253	LLE,TW RLE,TW	0 204 023 644 0 204 023 643	
	3.7 Nismo	03.13→	253	AG	0 265 005 806	

OPEL

Adam

	1.0	07.14→	66/85	LLE,STB RLE,STB 4SB,LLE 4SB,RLE	0 204 803 866 0 204 123 743 0 204 822 479 0 204 123 744	22,2 22,2 23,81
	1.2	03.13→	51	LLE,STB RLE,STB 4SB,LLE 4SB,RLE	0 204 803 866 0 204 123 743 0 204 822 479 0 204 123 744	22,2 22,2 23,81

		S							
◀ OPEL Adam									
	1.4	03.13→	64/74/110			LLE,STB	0 204 803 866	22,2	
	1.4 LPG					RLE,STB	0 204 123 743	22,2	
	1.4 Turbo					4SB,LLE	0 204 822 479		
						4SB,RLE	0 204 123 744	23,81	
	1.0	07.14→	66/85			LLE,STB	0 204 125 870		
						4SB,LLE	0 204 125 869		
	1.2	03.13→	51			LLE,STB	0 204 125 870		
						4SB,LLE	0 204 125 869		
	1.4, LPG, Turbo	03.13→	64/74/110			LLE,STB	0 204 125 870		
						4SB,LLE	0 204 125 869		
	1.0	07.14→	66/85				0 986 486 588	31	
	1.2	03.13→	51	Get.-Nr. F17		MG5	0 986 486 588	31	
	1.4, LPG, Turbo	03.13→	64/74/110	Get.-Nr. F17		MG5	0 986 486 588	31	
Agila [A]									
	1.0 i	ABO 06.00-02.08	43/44				0 204 123 540	20,64	
	1.0 Twinport	ABS 06.00-02.08	43/44			JBH	0 986 480 872	20,6	
	1.2 i	ABO 06.00-02.08	55/59				0 204 123 540	20,64	
	1.2 Twinport	ABS 06.00-02.08	55/59			JBH	0 986 480 872	20,6	
	1.3 CDTI	ABO 08.03-02.08	51				0 204 123 540	20,64	
		ABS 08.03-02.08	51			JBH	0 986 480 872	20,6	
	1.0 i, Twinport	06.00-02.08	43/44				0 204 125 742		
	1.2 i, Twinport	06.00-02.08	55/59				0 204 125 742		
	1.3 CDTI	08.03-02.08	51				0 204 125 742		
	1.0 i, Twinport	06.00-02.08	43/44				0 204 031 174 ^A		
	1.2 i, Twinport	06.00-02.08	55/59				0 204 031 174 ^A		
	1.3 CDTI	08.03-02.08	51				0 204 031 174 ^A		
Agila [B]									
	1.0 Twinport	MFD 03.08→	48-50			LLE	0 204 054 376	22,2	
						RLE	0 204 054 382	22,2	
		OFD 03.08→	48-50			LLE	0 204 054 366	22,2	
						RLE	0 204 051 327	22,2	
	1.2 Twinport	MFD 03.08→	63-69			LLE	0 204 054 376	22,2	
						RLE	0 204 054 382	22,2	
		OFD 03.08→	63-69			LLE	0 204 054 366	22,2	
						RLE	0 204 051 327	22,2	
	1.3 CDTI	MFD 03.08→	55			LLE	0 204 054 376	22,2	
						RLE	0 204 054 382	22,2	
		OFD 03.08→	55			LLE	0 204 054 366	22,2	
						RLE	0 204 051 327	22,2	
	1.0 Twinport	03.08→	48-50	Fg.-Nr. →AM999999			0 204 051 673		
		MFD 03.08→	48-50	Fg.-Nr. BM000001→		SSJ,TW	0 204 719 397		
							0 204 719 401		
						SSJ	0 204 054 136		
		OFD 03.08→	48-50	Fg.-Nr. BM000001→		SSJ,TW	0 204 719 396		
							0 204 719 400		
						SSJ	0 204 719 398		
	1.2 Twinport	03.08→	63-69	Fg.-Nr. →AM999999			0 204 051 673		
		MFD 03.08→	63-69	Fg.-Nr. BM000001→		SSJ,TW	0 204 719 397		
							0 204 719 401		
						SSJ	0 204 054 136		

		S							
1.2 Twinport		OFD 03.08→	63-69	Fg.-Nr. BM000001→	SSJ,TW		0 204 719 396		
							0 204 719 400		
					SSJ		0 204 719 398		
1.3 CDTI		03.08→	55	Fg.-Nr. →AM999999			0 204 051 673		
		MFD 03.08→	55	Fg.-Nr. BM000001→	SSJ,TW		0 204 719 397		
							0 204 719 401		
					SSJ		0 204 054 136		
		OFD 03.08→	55	Fg.-Nr. BM000001→	SSJ,TW		0 204 719 396		
							0 204 719 400		
					SSJ		0 204 719 398		
Antara									
	2.2 CDTI, CDTI 4x4	11.10→	120/135				0 986 486 579	34	
	3.0 V6, V6 4x4	01.12→	183		TW		0 986 486 579	34	
Arena									
	1.9 D	ABS 03.98-08.01	44				0 204 123 409		
	2.5 D	03.98-08.01	55		TW		0 204 123 409		
							0 204 123 651	23,8	
		ABO 03.98-08.01	55	Fg.-Nr. B030138→			0 204 123 651	23,8	
		ABS 03.98-08.01	55	Fg.-Nr. B030138→			0 204 123 409		
Astra Cabrio [F]									
	1.4 i	03.92-02.98	60		JBH,VEA ATE		0 986 480 752	22,2	
		ABO 09.91-02.98	44/60/66		DEL,JBH		0 986 480 130	20,6	
		ABS 09.91-02.98	44/60/66		DEL,JBH		0 986 480 129	22,2	
					JBH ATE		0 986 480 907	22	
	1.6 i	09.91-02.98	52/55/74		DEL,JBH		0 986 480 129	22,2	
					JBH ATE		0 986 480 907	22	
	1.8 i	ABO 09.91-08.98	66/85/92		DEL,JBH		0 986 480 130	20,6	
		ABS 09.91-08.98	66/85/92		DEL,JBH		0 986 480 129	22,2	
					JBH ATE		0 986 480 907	22	
	2.0 i	09.91-02.98	85/100/110		JBH ATE		0 986 480 752	22,2	
		ABS 09.91-02.98	85/100/ 110		DEL,JBH		0 986 480 129	22,2	
					JBH ATE		0 986 480 907	22	
	1.4 i	03.92-02.98	60		RLE ATE		0 986 485 109		
	1.6 i	09.91-02.98	52/55/74		RLE ATE		0 986 485 109		
	1.8 i	09.93-08.98	85/92		RLE ATE		0 986 485 109		
	2.0 i	09.91-02.98	85/100/110		RLE ATE		0 986 485 109		
	1.4 i	09.91-02.98	44/60/66				0 265 208 311 ^H		
	1.6 i	09.91-02.98	52/55/74				0 265 208 311 ^H		
	1.8 i	09.91-08.98	66/85/92				0 265 208 311 ^H		
	2.0 i	09.91-02.98	85/100/110				0 265 208 311 ^H		
Astra Cabrio [G]									
	1.4 i	MFD 09.97-08.05	66		JBH		0 986 481 028	23,81	
		OFD 09.97-08.05	66		JBH		0 986 480 699	23,8	
	1.6 i	09.00-08.05	74		JBH		0 986 480 699	23,8	
		MFD 09.97-08.00	74		JBH		0 986 481 028	23,81	
		OFD 09.97-08.00	74		JBH		0 986 480 699	23,8	
	1.6 Twinport	MFD 03.03-08.05	76		JBH		0 986 481 028	23,81	
		OFD 03.03-08.05	76		JBH		0 986 480 699	23,8	

◀ OPEL Astra Cabrio [G]								
1.7 CDTI	MFD	03.03-08.05	59		JBH	0 986 481 028	23,81	
	OFD	03.03-08.05	59		JBH	0 986 480 699	23,8	
1.8 i		09.00-08.05	92		JBH	0 986 480 699	23,8	
	2.0 Turbo	MFD	03.02-08.05	141-147		JBH	0 986 481 028	23,81
OFD		03.02-08.05	141-147		JBH	0 986 480 699	23,8	
2.2 DTI	MFD	03.02-08.05	92		JBH	0 986 481 028	23,81	
	OFD	03.02-08.05	92		JBH	0 986 480 699	23,8	
2.2 i		09.00-08.05	108		JBH	0 986 480 699	23,8	
	1.4 i		09.97-08.05	66	LLE	0 986 486 068		
	1.6 i, Twinport		09.97-08.05	74/76	LLE	0 986 486 068		
	1.7 CDTI		03.03-08.05	59	LLE	0 986 486 068		
	1.8 i		09.00-08.05	92	LLE	0 986 486 068		
	2.0 Turbo		03.02-08.05	141-147	LLE	0 986 486 068		
	2.2 i		09.00-08.05	108	LLE	0 986 486 068		
	1.4 i		09.97-08.05	66	F13	0 986 486 588	31	
	1.6 i, Twinport		09.97-08.05	74/76	F13	0 986 486 588	31	
	1.7 CDTI		03.03-08.05	59	F13	0 986 486 588	31	
	1.8 i		09.00-08.05	92	F13	0 986 486 588	31	
	1.4 i		09.97-02.05	66		Fg.-Nr. →X2014819, →X5009355, →X6006066, →X8005679	0 265 216 474 ^B	
						Fg.-Nr. X2014820→, X5009356→, X6006067→, X8005680→	0 265 216 652 ^B	
			09.00-08.05	66			0 265 216 652 ^B	
	1.6 i		09.97-08.00	74		Fg.-Nr. →X2014819, →X5009355, →X6006066, →X8005679	0 265 216 474 ^B	
						Fg.-Nr. X2014820→, X5009356→, X6006067→, X8005680→	0 265 216 652 ^B	
			09.00-08.05	74			0 265 216 652 ^B	
	1.6 Twinport		03.03-08.05	76			0 265 202 509 ^T	
	1.7 CDTI		03.03-08.05	59			0 265 216 652 ^B	
	1.8 i		09.00-08.05	92		Fg.-Nr. →12999999, →15999999, →16999999, →18999999, →1B999999	0 265 220 585 ^B	
						Fg.-Nr. 2B000001→2B999999	0 265 202 492 ^T	
						Fg.-Nr. 3B000001→	0 265 202 509 ^T	
	2.0 Turbo		03.02-08.05	141-147		Fg.-Nr. 2B000001→	0 265 220 637 ^F	
						Fg.-Nr. 2B000001→2B999999	0 265 202 492 ^T	
						Fg.-Nr. 3B000001→	0 265 202 509 ^T	
	2.2 DTI		03.02-08.05	92		Fg.-Nr. 2B000001→	0 265 220 637 ^F	
					Fg.-Nr. 2B000001→2B999999	0 265 202 492 ^T		
					Fg.-Nr. 3B000001→	0 265 202 509 ^T		
2.2 i		09.00-08.05	108		Fg.-Nr. →1B999999	0 265 220 585 ^B		
					Fg.-Nr. →2B999999	0 265 202 492 ^T		
					Fg.-Nr. 2B000001→	0 265 220 637 ^F		
					Fg.-Nr. 3B000001→	0 265 202 509 ^T		
	1.6 Twinport		03.03-08.05	76			0 265 005 262	
	1.8 i		09.00-08.05	92			0 265 005 262	
	2.0 Turbo		03.02-08.05	141-147			0 265 005 262	
	2.2 DTI, i		09.00-0, 8.05	92/108			0 265 005 262	
	1.6 Twinport		03.03-08.05	76			0 265 005 435	
	1.8 i		09.00-08.05	92		Fg.-Nr. 1B000001→	0 265 005 433	
						Fg.-Nr. 12000001→, 1H000001→, 22000001→, 25000001→, 26000001→, 28000001→, 2H000001→, 1B000001→	0 265 005 435	
	2.2 DTI		03.02-08.05	92		Fg.-Nr. →YB999999	0 265 005 433	
						Fg.-Nr. 12000001→, 1H000001→, 22000001→, 25000001→, 26000001→, 28000001→, 2H000001→, 1B000001→	0 265 005 435	
2.2 i		09.00-08.05	108			0 265 005 435		



	1.6 Twinport	03.03-08.05	76			0 265 005 303	
	1.8 i	09.00-08.05	92			0 265 005 303	
	2.0 Turbo	03.02-08.05	141-147			0 265 005 303	
	2.2 DTI, i	09.00-08.05	92/108			0 265 005 303	

Astra Caravan [F]



	1.4 i	03.92-02.98	60		JBH,VEA ATE	0 986 480 752	22,2
		ABO 09.91-02.98	44/60/66		DEL,JBH	0 986 480 130	20,6
		ABS 09.91-02.98	44/60/66		DEL,JBH	0 986 480 129	22,2
					JBH ATE	0 986 480 907	22
	1.6 i	09.91-02.98	55/74		DEL,JBH	0 986 480 129	22,2
		09.92-07.96	52		JBH ATE	0 986 480 907	22
		ABO 09.92-07.96	52		DEL,JBH	0 986 480 130	20,6
		ABS 09.92-07.96	52		DEL,JBH	0 986 480 129	22,2
	1.7 D	12.91-02.98	42-44/50/60		JBH,VEA ATE	0 986 480 752	22,2
	1.7 TD	ABO 12.91-02.98	42-44/50/60		DEL,JBH	0 986 480 130	20,6
		ABS 12.91-02.98	42-44/50/60		DEL,JBH	0 986 480 129	22,2
			60		JBH ATE	0 986 480 907	22
	1.8 i	09.95-08.97	82/85		JBH ATE	0 986 480 752	22,2
		ABO 09.91-02.98	66/92		DEL,JBH	0 986 480 130	20,6
		ABS 09.91-02.98	66/82/85/92		DEL,JBH	0 986 480 129	22,2
			92		JBH ATE	0 986 480 907	22
	2.0 i	09.91-02.98	85/100/110		JBH ATE	0 986 480 752	22,2
		ABS 09.91-02.98	85/100/110		DEL,JBH	0 986 480 129	22,2
					JBH ATE	0 986 480 907	22

	1.4 i	03.92-02.98	60		RLE ATE	0 986 485 109	
	1.6 i	09.91-02.98	52/55/74		RLE ATE	0 986 485 109	
	1.7 D, TD	12.91-02.98	42-44/50/60		RLE ATE	0 986 485 109	
	1.8 i	09.93-08.98	82/85/92		RLE ATE	0 986 485 109	
	2.0 i	09.91-02.98	85/100/110		RLE ATE	0 986 485 109	

	1.4 i	09.91-02.98	44/60/66			0 265 208 311 ^H	
	1.6 i	09.91-02.98	52/55/74			0 265 208 311 ^H	
	1.7 D, TD	12.91-02.98	42-44/50/60			0 265 208 311 ^H	
	1.8 i	09.91-08.98	66/82/85/92			0 265 208 311 ^H	
	2.0 i	09.91-02.98	85/100/110			0 265 208 311 ^H	

Astra Caravan [G]





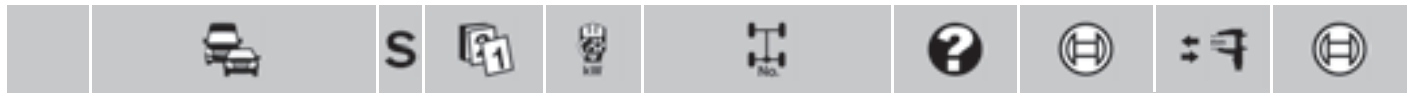







	1.2 i	MFD 09.97-09.03	48/55		JBH	0 986 481 028	23,81
		OFD 09.00-09.03	55	Fg.-Nr. 22000001→, 25000001→, 26000001→, 28000001→, 2H000001→	JBH	0 986 480 699	23,8
	1.4 i	MFD 09.97-07.09	66		JBH	0 986 481 028	23,81
	1.4 Twinport	OFD 09.97-07.09	66		JBH	0 986 480 699	23,8
	1.6 i, i CNG, i Twinport	MFD 09.97-07.09	55/62/69-73/74/76		JBH	0 986 481 028	23,81
		OFD 09.97-07.09	55/62/69-73/74/76		JBH	0 986 480 699	23,8
	1.7 CDTI, DT, DTI	MFD 03.98-07.09	50/55/59		JBH	0 986 481 028	23,81
		OFD 03.98-07.09	50/55/59		JBH	0 986 480 699	23,8
	1.8 i	MFD 09.97-06.04	85/92		JBH	0 986 481 028	23,81
		OFD 09.97-06.04	85/92		JBH	0 986 480 699	23,8
	2.0 DT, DTI, DTL, i, Turbo	MFD 09.97-06.04	60/74/100/118/141-147		JBH	0 986 481 028	23,81
		OFD 09.97-06.04	60/74/100/118/141-147		JBH	0 986 480 699	23,8
	2.2 DTI	MFD 09.00-06.04	92/108		JBH	0 986 481 028	23,81
	2.2 i	OFD 09.00-06.04	92/108		JBH	0 986 480 699	23,8



◀ OPEL Astra Caravan [G]

	1.2 i	09.97-09.03	48/55		LLE	0 986 486 068		
	1.4 i, Twinport	09.97-07.09	66		LLE	0 986 486 068		
	1.6 i, i Twinport	09.97-07.09	55/62/74/76		LLE	0 986 486 068		
	1.7 CDTI, DT, DTI	03.98-07.09	50/55/59		LLE	0 986 486 068		
	1.8 i	09.97-06.04	85/92		LLE	0 986 486 068		
	2.0 DT, DTI, DTL, i, Turbo	09.97-06.04	60/74/100/118/141-147		LLE	0 986 486 068		
	2.2 DTI, i	09.00-06.04	92/108		LLE	0 986 486 068		
	1.2 i	09.97-09.03	48/55		F13	0 986 486 588	31	
	1.4 i, Twinport	09.97-07.09	66		F13	0 986 486 588	31	
	1.6 i	09.97-06.04	74		F13	0 986 486 588	31	
		09.00-06.04	62		F13	0 986 486 588	31	
	1.6 i CNG	09.02-06.04	69-73			0 986 486 588	31	
	1.6 i Twinport	03.03-07.09	76			0 986 486 588	31	
	1.7 CDTI, DT, DTI	03.98-07.09	50/55/59		F13	0 986 486 588	31	
	1.8 i	09.97-06.04	85/92		F13	0 986 486 588	31	
	2.0 DT, DTI, DTL, i	09.97-06.04	60/74/100		F18	0 986 486 593	34	
	2.0 i	10.99-09.02	118		F23	0 986 486 585	34	
		1.2 i	09.97-09.03	48	Fg.-Nr. →X2014819, →X5009355, →X6006066, →X8005679		0 265 216 474 ^B	
					Fg.-Nr. X2014820→, X5009356→, X6006067→, X8005680→		0 265 216 652 ^B	
			09.00-09.03	55			0 265 216 652 ^B	
1.4 i		09.97-09.00	66	Fg.-Nr. →X2014819, →X5009355, →X6006066, →X8005679		0 265 216 474 ^B		
				Fg.-Nr. X2014820→, X5009356→, X6006067→, X8005680→		0 265 216 652 ^B		
		09.00-06.04	66			0 265 216 652 ^B		
1.4 Twinport		09.03-07.09	66			0 265 216 652 ^B		
1.6 i		09.97-08.00	55	Fg.-Nr. →X2014819, →X5009355, →X6006066, →X8005679		0 265 216 474 ^B		
				Fg.-Nr. X2014820→, X5009356→, X6006067→, X8005680→		0 265 216 652 ^B		
		09.97-01.04	74			0 265 202 509 ^T		
		09.97-06.04	74	Fg.-Nr. →X2014819, →X5009355, →X6006066, →X8005679		0 265 216 474 ^B		
				Fg.-Nr. X2014820→, X5009356→, X6006067→, X8005680→		0 265 216 652 ^B		
		09.00-06.04	62			0 265 216 652 ^B		
			74			0 265 216 652 ^B		
				Fg.-Nr. →32035797, →35033917, →38004448		0 265 202 492 ^T		
1.6 i CNG		09.02-06.04	69-73			0 265 202 509 ^T		
						0 265 216 652 ^B		
1.6 i Twinport		03.03-07.09	76			0 265 202 509 ^T		
						0 265 216 652 ^B		
1.7 CDTI, DTI		09.00-07.09	55/59			0 265 216 652 ^B		
1.7 DT		03.98-08.00	50	Fg.-Nr. →X2014819, →X5009355, →X6006066, →X8005679		0 265 216 474 ^B		
				Fg.-Nr. X2014820→, X5009356→, X6006067→, X8005680→		0 265 216 652 ^B		
1.8 i	09.97-08.00	85			0 265 202 458 ^T			
			Fg.-Nr. →X2040738, →X5028417, →X6006066, →X8013993		0 265 220 450 ^F			
			Fg.-Nr. X2040739→, X5028418→, X6006067→, X8013994→		0 265 220 532 ^F			
	09.00-06.04	92	Fg.-Nr. →12999999, →15999999, →16999999, →18999999, →1B999999		0 265 220 585 ^B			
			Fg.-Nr. →32035797, →35033917, →38004448		0 265 202 492 ^T			

		S							
1.8 i	09.00-06.04	92	Fg.-Nr. 22000001→, 25000001→, 26000001→, 28000001→			0 265 220 637 ^F			
			Fg.-Nr. 32035798→, 35033918→, 38004449→			0 265 202 509 ^T			
	03.01-06.04	85	Fg.-Nr. →12999999, →15999999, →16999999, →18999999, →1B999999			0 265 220 585 ^B			
			Fg.-Nr. →32035797, →35033917, →38004448			0 265 202 492 ^T			
			Fg.-Nr. 22000001→, 25000001→, 26000001→, 28000001→			0 265 220 637 ^F			
			Fg.-Nr. 32035798→, 35033918→, 38004449→			0 265 202 509 ^T			
2.0 DT	03.98-08.00	60	Fg.-Nr. →X2014819, →X5009355, →X6006066, →X8005679			0 265 216 474 ^B			
			Fg.-Nr. X2014820→, X5009356→, X6006067→, X8005680→			0 265 216 652 ^B			
2.0 DTI	09.00-06.04	74				0 265 216 652 ^B			
			Fg.-Nr. 22000001→, 25000001→, 26000001→, 28000001→			0 265 220 637 ^F			
2.0 DTL	09.00-06.04	60				0 265 216 652 ^B			
2.0 i	09.97-06.04	100	Fg.-Nr. →X2040738, →X5028417, →X6006066, →X8013993			0 265 220 450 ^F			
			Fg.-Nr. X2040739→, X5028418→, X6006067→, X8013994→			0 265 220 532 ^F			
			10.99-09.02 118			0 265 220 532 ^F			
2.0 Turbo	09.01-06.04	141-147				0 265 220 585 ^B			
			Fg.-Nr. →32035797, →35033917, →38004448			0 265 202 492 ^T			
			Fg.-Nr. 32035798→, 35033918→, 38004449→			0 265 202 509 ^T			
2.2 DTI	09.01-06.04	92				0 265 220 637 ^F			
			Fg.-Nr. →32035797, →35033917, →38004448			0 265 202 492 ^T			
			Fg.-Nr. 32035798→, 35033918→, 38004449→			0 265 202 509 ^T			
2.2 i	09.00-06.04	108	Fg.-Nr. →12999999, →15999999, →16999999, →18999999, →1B999999			0 265 220 585 ^B			
			Fg.-Nr. →32035797, →35033917, →38004448			0 265 202 492 ^T			
				Fg.-Nr. 22000001→, 25000001→, 26000001→, 28000001→			0 265 220 637 ^F		
				Fg.-Nr. 32035798→, 35033918→, 38004449→			0 265 202 509 ^T		
	1.6 i, i CNG, i Twinport	09.00-07.09	69-73/74/76		0 265 005 262				
	1.8 i	09.97-06.04	85/92		0 265 005 262				
	2.0 Turbo	09.01-06.04	141-147		0 265 005 262				
	2.2 DTI	09.01-06.04	92	Fg.-Nr. 22000001→, 2B000001→, 2H000001→, 25000001→, 26000001→, 28000001→		0 265 005 262			
2.2 i	09.00-06.04	108		0 265 005 262					
	1.6 i, i CNG, i Twinport	09.00-07.09	69-73/74/76		0 265 005 435				
	1.8 i	09.97-08.00	85		0 265 005 435				
		09.00-06.04	92		0 265 005 435				
	2.0 Turbo	09.01-06.04	141-147	Fg.-Nr. 12000001→, 1H000001→, 22000001→, 25000001→, 26000001→, 28000001→, 2H000001→, 1B000001→		0 265 005 435			
						0 265 005 435			



◀ OPEL Astra Caravan [G]										
2.2 DTI		09.00-06.04	92/108	Fg.-Nr. 12000001→, 1H000001→,				0 265	005 435	
2.2 i				22000001→, 25000001→, 26000001→,						
				28000001→, 2H000001→, 1B000001→						
1.6 i, i Twinport		09.00-07.09	74/76					0 265	005 303	
1.8 i		09.97-06.04	85/92					0 265	005 303	
2.0 Turbo		09.01-06.04	141-147					0 265	005 303	
2.2 DTI, i		09.00-06.04	92/108					0 265	005 303	
Astra Caravan [H]										
1.2 Twinport	MFD	03.07-03.09	59	Fg.-Nr. →62999999, →65999999, →68999999	JBH,LLE,RLE			0 986	480 856	25,4
				Fg.-Nr. 72000001→, 75000001→, 78000001→	LLE,RLE			0 986	481 059	25,4
	OFD	03.07-03.09	59	Fg.-Nr. →62999999, →65999999, →68999999	JBH,LLE			0 986	480 880	25,4
				Fg.-Nr. 72000001→, 75000001→, 78000001→	LLE			0 986	481 058	25,4
1.3 CDTI	MFD	08.05-03.10	66	Fg.-Nr. →62999999, →65999999, →68999999	JBH,LLE,RLE			0 986	480 856	25,4
				Fg.-Nr. 72000001→, 75000001→, 78000001→	LLE,RLE			0 986	481 059	25,4
	OFD	08.05-03.10	66	Fg.-Nr. →62999999, →65999999, →68999999	JBH,LLE			0 986	480 880	25,4
				Fg.-Nr. 72000001→, 75000001→, 78000001→	LLE			0 986	481 058	25,4
1.4	MFD	08.04-03.10	55/66	Fg.-Nr. →62999999, →65999999, →68999999	JBH,LLE,RLE			0 986	480 856	25,4
1.4 Twinport				Fg.-Nr. 72000001→, 75000001→, 78000001→	LLE,RLE			0 986	481 059	25,4
	OFD	08.04-03.10	55/66	Fg.-Nr. →62999999, →65999999, →68999999	JBH,LLE			0 986	480 880	25,4
				Fg.-Nr. 72000001→, 75000001→, 78000001→	LLE			0 986	481 058	25,4
1.6		01.11→	85		TW			0 986	481 058	25,4
								0 986	481 059	25,4
1.6	MFD	08.04-03.10	77/85/132	Fg.-Nr. →62999999, →65999999, →68999999	JBH,LLE,RLE			0 986	480 856	25,4
1.6 Turbo				Fg.-Nr. 72000001→, 75000001→, 78000001→	LLE,RLE			0 986	481 059	25,4
1.6 Twinport	OFD	08.04-03.10	77/85/132	Fg.-Nr. →62999999, →65999999, →68999999	JBH,LLE			0 986	480 880	25,4
				Fg.-Nr. 72000001→, 75000001→, 78000001→	LLE			0 986	481 058	25,4
1.7 CDTI		02.07→	81/92		TW			0 986	481 058	25,4
								0 986	481 059	25,4
	MFD	08.04-03.10	59/74/81/92	Fg.-Nr. →62999999, →65999999, →68999999	JBH,LLE,RLE			0 986	480 856	25,4
				Fg.-Nr. 72000001→, 75000001→, 78000001→	LLE,RLE			0 986	481 059	25,4
	OFD	08.04-03.10	59/74/81/92	Fg.-Nr. →62999999, →65999999, →68999999	JBH,LLE			0 986	480 880	25,4
				Fg.-Nr. 72000001→, 75000001→, 78000001→	LLE			0 986	481 058	25,4
1.8 i		01.11→	103		TW			0 986	481 058	25,4
								0 986	481 059	25,4
	MFD	08.04-03.10	92/103	Fg.-Nr. →62999999, →65999999, →68999999	JBH,LLE,RLE			0 986	480 856	25,4
				Fg.-Nr. 72000001→, 75000001→, 78000001→	LLE,RLE			0 986	481 059	25,4

		S							
1.8 i	OFD	08.04-03.10	92/103	Fg.-Nr. →62999999, →65999999, →68999999	JBH,LLE		0 986 480 880	25,4	
				Fg.-Nr. 72000001→, 75000001→, 78000001→	LLE		0 986 481 058	25,4	
2.0 Turbo	MFD	08.04-03.10	125/147/ 177	Fg.-Nr. →62999999, →65999999, →68999999	JBH,LLE, RLE		0 986 480 856	25,4	
				Fg.-Nr. 72000001→, 75000001→, 78000001→	LLE,RLE		0 986 481 059	25,4	
	OFD	08.04-03.10	125/147/ 177	Fg.-Nr. →62999999, →65999999, →68999999	JBH,LLE		0 986 480 880	25,4	
				Fg.-Nr. 72000001→, 75000001→, 78000001→	LLE		0 986 481 058	25,4	
1.2 Twinport		03.07-03.09	59		LLE		0 986 486 068		
1.3 CDTI		08.05-03.10	66		LLE		0 986 486 068		
1.4, Twinport		08.04-03.10	55/66		LLE		0 986 486 068		
1.6		03.07-03.10	85		LLE		0 986 486 068		
		01.11→	85		LLE		0 986 486 068		
1.6 Turbo		09.07-03.10	132		LLE		0 986 486 068		
1.6 Twinport		08.04-03.07	77		LLE		0 986 486 068		
		09.07-03.09	77		LLE		0 986 486 068		
1.7 CDTI		08.04→	59/74/81/92		LLE		0 986 486 068		
1.8 i		08.04-02.09	92		LLE		0 986 486 068		
		08.05-03.10	103		LLE		0 986 486 068		
		01.11→	103		LLE		0 986 486 068		
1.9 CDTI		09.04-07.10	74/88/110		LLE		0 986 486 068		
2.0 Turbo		08.04-03.10	125/147/177		LLE		0 986 486 068		
1.2 Twinport		03.07-03.09	59	Get.-Nr. M20	EAY		0 986 486 589	34	
1.3 CDTI		08.05-03.10	66		F13,TW		0 986 486 588	31	
				Get.-Nr. F13	TW		0 986 486 584	31	
				Get.-Nr. M20	EAY		0 986 486 589	34	
				Get.-Nr. M20, Get.-Nr. M32	GS		0 986 486 591	34	
1.4		08.04-03.10	55/66		F13,TW		0 986 486 588	31	
1.4 Twinport				Get.-Nr. F13	TW		0 986 486 584	31	
				Get.-Nr. M20	EAY		0 986 486 589	34	
					GS		0 986 486 591	34	
1.6		03.07-03.10	85		F13,TW		0 986 486 588	31	
				Get.-Nr. F13	TW		0 986 486 584	31	
				Get.-Nr. M20	EAY		0 986 486 589	34	
					GS		0 986 486 591	34	
		01.11→	85	Get.-Nr. F13	GS,TW		0 986 486 584	31	
				Get.-Nr. F13, Get.-Nr. F17	EAY,GS,TW		0 986 486 588	31	
				Get.-Nr. M20	EAY		0 986 486 589	34	
				Get.-Nr. M20, Get.-Nr. M32	GS,TW		0 986 486 591	34	
1.6 Turbo		09.07-03.10	132		F13,TW		0 986 486 588	31	
				Get.-Nr. F13	TW		0 986 486 584	31	
				Get.-Nr. M20	EAY		0 986 486 589	34	
				Get.-Nr. M20, Get.-Nr. M32	GS		0 986 486 591	34	
1.6 Twinport		08.04-03.07	77		F13,TW		0 986 486 588	31	
				Get.-Nr. F13	TW		0 986 486 584	31	
				Get.-Nr. M20	EAY		0 986 486 589	34	
					GS		0 986 486 591	34	
		09.07-03.09	77		F13,TW		0 986 486 588	31	
				Get.-Nr. F13	TW		0 986 486 584	31	
				Get.-Nr. M20	EAY		0 986 486 589	34	
					GS		0 986 486 591	34	
1.7 CDTI		08.04-09.05	59		F13,TW		0 986 486 588	31	
				Get.-Nr. F13	TW		0 986 486 584	31	
				Get.-Nr. M20	EAY		0 986 486 589	34	
					GS		0 986 486 591	34	



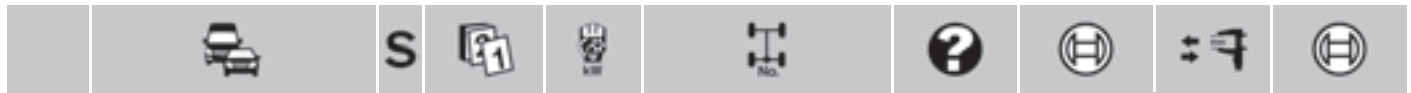

	◀ OPEL Astra Caravan [H]					
1.7 CDTI	08.04-03.07	74		F13,TW	0986 486 588	31
			Get.-Nr. F13	TW	0986 486 584	31
			Get.-Nr. M20	EAY	0986 486 589	34
			Get.-Nr. M20, Get.-Nr. M32	GS	0986 486 591	34
	02.07-03.10	81/92		EAY	0986 486 588	31
				EAY	0986 486 594	34
	02.07→	81/92	Get.-Nr. F13	GS,TW	0986 486 584	31
			Get.-Nr. F13, Get.-Nr. F17	EAY,GS,TW	0986 486 588	31
			Get.-Nr. M20	EAY	0986 486 589	34
				GS,TW	0986 486 591	34
			Get.-Nr. M32	GS,TW	0986 486 594	34
1.8 i	08.04-02.09	92		F13,TW	0986 486 588	31
			Get.-Nr. F13	TW	0986 486 584	31
			Get.-Nr. M20	EAY	0986 486 589	34
				GS	0986 486 591	34
	08.05-03.10	103		F13,TW	0986 486 588	31
			Get.-Nr. F13	TW	0986 486 584	31
			Get.-Nr. M20	EAY	0986 486 589	34
				GS	0986 486 591	34
	01.11→	103	Get.-Nr. F13	GS,TW	0986 486 584	31
			Get.-Nr. F13, Get.-Nr. F17	EAY,GS,TW	0986 486 588	31
			Get.-Nr. M20	EAY,TW	0986 486 589	34
			Get.-Nr. M20, Get.-Nr. M32	GS,TW	0986 486 591	34
1.9 CDTI	09.04-03.10	88/110			0986 486 590	34
	09.05-07.10	74	Get.-Nr. F13	MG5,TW	0986 486 584	31
			Get.-Nr. F13, Get.-Nr. F17	EAY,MG5,TW	0986 486 588	31
			Get.-Nr. M20	EAY	0986 486 589	34
				MG6,TW	0986 486 591	34
			Get.-Nr. M32	MG6,TW	0986 486 590	34
2.0 Turbo	08.04-03.10	125/147/177			0986 486 588	31

Astra Classic Caravan [F]

1.4 i	ABO	09.97-08.02	44	DEL,JBH	0986 480 130	20,6
	ABS	09.97-08.02	44	JBH ATE	0986 480 907	22
1.6 i	ABO	09.97-08.02	55	DEL,JBH	0986 480 130	20,6
			74	DEL,JBH	0986 480 132	22,2
	ABS	09.97-08.02	55/74	JBH ATE	0986 480 907	22

	1.4 i	09.97-08.02	44		0265 208 311^H	
	1.6 i	09.97-08.02	55/74		0265 208 311^H	

Astra Classic [F]

1.4 i	ABO	09.97-08.02	44	DEL,JBH	0986 480 130	20,6
	ABS	09.97-08.02	44	JBH ATE	0986 480 907	22
1.6 i	ABO	09.97-08.02	55	DEL,JBH	0986 480 130	20,6
			74	DEL,JBH	0986 480 132	22,2
	ABS	09.97-08.02	55/74	JBH ATE	0986 480 907	22











	1.4 i	09.97-08.02	44		0265 208 311^H	
	1.6 i	09.97-08.02	55/74		0265 208 311^H	

Astra Coupé [G]

1.6 Twinport	MFD	03.03-02.05	76	JBH	0986 481 028	23,81
	OFD	03.03-02.05	76	JBH	0986 480 699	23,8
1.7 CDTI	MFD	03.03-02.05	59	JBH	0986 481 028	23,81
	OFD	03.03-02.05	59	JBH	0986 480 699	23,8

		S								
1.8 i	MFD	09.97-02.05	85/92			JBH	0 986 481 028	23,81		
	OFD	09.97-02.05	85/92			JBH	0 986 480 699	23,8		
2.0 Turbo	MFD	09.00-02.05	141-147			JBH	0 986 481 028	23,81		
	OFD	09.00-02.05	141-147			JBH	0 986 480 699	23,8		
2.2 DTI	MFD	09.00-02.05	92/108			JBH	0 986 481 028	23,81		
2.2 i	OFD	09.00-02.05	92/108			JBH	0 986 480 699	23,8		
	1.6 Twinport	03.03-02.05	76			LLE	0 986 486 068			
	1.7 CDTI	03.03-02.05	59			LLE	0 986 486 068			
	1.8 i	09.97-02.05	85/92			LLE	0 986 486 068			
	2.0 Turbo	09.00-02.05	141-147			LLE	0 986 486 068			
	2.2 i	09.00-02.05	108			LLE	0 986 486 068			
	1.6 Twinport	03.03-02.05	76			F13	0 986 486 588	31		
	1.7 CDTI	03.03-02.05	59			F13	0 986 486 588	31		
	1.8 i	09.97-02.05	85/92			F13	0 986 486 588	31		
	1.6 Twinport	03.03-02.05	76				0 265 202 509 ^T			
	1.7 CDTI	03.03-02.05	59				0 265 216 652 ^B			
	1.8 i	09.97-08.00	85				0 265 220 532 ^F			
		09.00-02.05	85/92	Fg.-Nr. →12999999, →15999999, →16999999, →18999999, →1B999999			0 265 220 585 ^B			
				Fg.-Nr. 2B000001→2B999999			0 265 202 492 ^T			
				Fg.-Nr. 3B000001→			0 265 202 509 ^T			
	2.0 Turbo	09.00-02.05	141-147	Fg.-Nr. →12999999, →15999999, →16999999, →18999999, →1B999999			0 265 220 585 ^B			
				Fg.-Nr. 2B000001→2B999999			0 265 202 492 ^T			
				Fg.-Nr. 3B000001→			0 265 202 509 ^T			
	2.2 DTI	03.02-02.05	92	Fg.-Nr. 2B000001→			0 265 220 637 ^F			
				Fg.-Nr. 2B000001→2B999999			0 265 202 492 ^T			
				Fg.-Nr. 3B000001→			0 265 202 509 ^T			
	2.2 i	09.00-02.05	108	Fg.-Nr. →1B999999			0 265 220 585 ^B			
Fg.-Nr. →2B999999						0 265 202 492 ^T				
Fg.-Nr. 2B000001→						0 265 220 637 ^F				
			Fg.-Nr. 3B000001→			0 265 202 509 ^T				
	1.8 i	09.00-02.05	85/92				0 265 005 262			
	2.0 Turbo	09.00-02.05	141-147				0 265 005 262			
	2.2 DTI, i	09.00-02.05	92/108				0 265 005 262			
	1.8 i	09.00-02.05	92				0 265 005 433			
		03.01-02.05	85				0 265 005 435			
	2.0 Turbo	09.00-02.05	141-147	Fg.-Nr. 12000001→, 1H000001→, 22000001→, 25000001→, 26000001→, 28000001→, 2H000001→, 1B000001→			0 265 005 435			
				Fg.-Nr. 12000001→, 1H000001→, 22000001→, 25000001→, 26000001→, 28000001→, 2H000001→, 1B000001→			0 265 005 435			
				Fg.-Nr. 12000001→, 1H000001→, 22000001→, 25000001→, 26000001→, 28000001→, 2H000001→, 1B000001→			0 265 005 435			
2.2 i	09.00-02.05	108				0 265 005 435				
	1.6 Twinport	03.03-02.05	76				0 265 005 303			
	1.8 i	09.00-02.05	85/92				0 265 005 303			
	2.0 Turbo	09.00-02.05	141-147				0 265 005 303			
	2.2 DTI, i	09.00-02.05	92/108				0 265 005 303			
Astra [F]										
	1.4 i	03.92-02.98	60			JBH, VEA ATE	0 986 480 752	22,2		
		ABO	09.91-02.98	44/60/66			DEL, JBH	0 986 480 130	20,6	
		ABS	09.91-02.98	44/60/66			DEL, JBH	0 986 480 129	22,2	
							JBH ATE	0 986 480 907	22	

		S								
◀ OPEL Astra [F]										
	1.6 i		09.94-02.98	74		JBH	ATE	0 986 480 907	22	
		ABO	09.91-02.98	52/55		DEL,JBH		0 986 480 130	20,6	
			03.92-02.98	74		DEL,JBH		0 986 480 130	20,6	
			09.94-02.98	74		DEL,JBH		0 986 480 132	22,2	
	ABS		09.91-02.98	52/55		DEL,JBH		0 986 480 129	22,2	
			03.92-02.98	74		DEL,JBH		0 986 480 129	22,2	
						JBH	ATE	0 986 480 907	22	
						DEL,JBH		0 986 480 907	22	
	1.7 D		12.91-08.94	42-44		JBH,VEA	ATE	0 986 480 752	22,2	
	1.7 D	ABO	12.91-02.98	42-44/50/60		DEL,JBH		0 986 480 130	20,6	
1.7 TD	ABS		12.91-02.98	42-44/50/60		DEL,JBH		0 986 480 129	22,2	
						JBH	ATE	0 986 480 907	22	
1.8 i		09.93-08.98	85/92		JBH	ATE	0 986 480 752	22,2		
	ABO	09.91-02.98	66		DEL,JBH		0 986 480 130	20,6		
	ABS		09.91-08.98	66/82/85/92		DEL,JBH		0 986 480 129	22,2	
					JBH	ATE	0 986 480 907	22		
2.0 i		09.91-02.98	85		JBH	ATE	0 986 480 752	22,2		
	ABS		09.91-02.98	85/100/110		DEL,JBH		0 986 480 129	22,2	
						JBH	ATE	0 986 480 907	22	
	1.4 i		03.92-02.98	60		RLE	ATE	0 986 485 109		
	1.7 D		12.91-08.94	42-44		RLE	ATE	0 986 485 109		
	1.8 i		09.93-08.98	85/92		RLE	ATE	0 986 485 109		
	2.0 i		09.91-02.98	85/110		RLE	ATE	0 986 485 109		
	1.4 i		09.91-02.98	44/60/66				0 265 208 311 ^H		
	1.6 i		09.91-02.98	52/55/74				0 265 208 311 ^H		
	1.7 D, TD		12.91-02.98	42-44/50/60				0 265 208 311 ^H		
	1.8 i		09.91-08.98	66/85/92				0 265 208 311 ^H		
	2.0 i		09.91-02.98	85/100/110				0 265 208 311 ^H		
Astra [G]										
	1.2 i	MFD	09.97-09.03	48/55		JBH		0 986 481 028	23,81	
		OFD	09.00-09.03	55	Fg.-Nr. 22000001→, 25000001→, 26000001→, 28000001→, 2H000001→	JBH		0 986 480 699	23,8	
	1.4 i	MFD	09.97-01.04	66		JBH		0 986 481 028	23,81	
		OFD	09.97-01.04	66		JBH		0 986 480 699	23,8	
	1.4 Twinport		09.03-06.09	66		JBH		0 986 480 699	23,8	
	1.6 i		10.99-12.05	74		JBH		0 986 480 699	23,8	
		OFD		09.97-01.04	74		JBH		0 986 480 699	23,8
				09.97-01.05	55/62		JBH		0 986 480 699	23,8
	1.6 i Twinport	OFD	03.03-07.09	76		JBH		0 986 480 699	23,8	
	1.6 i, i Twinport	MFD	09.97-07.09	55/62/74/76		JBH		0 986 481 028	23,81	
	1.7 CDTI, DT, DTI	MFD	03.98-01.04	50/55/59		JBH		0 986 481 028	23,81	
		OFD	03.98-01.04	50/55/59		JBH		0 986 480 699	23,8	
	1.8 i		10.99-12.02	85		JBH		0 986 480 699	23,8	
			01.03-12.05	92		JBH		0 986 480 699	23,8	
		MFD	09.97-01.04	85/92		JBH		0 986 481 028	23,81	
		OFD		09.97-08.00	85		JBH		0 986 480 699	23,8
				09.00-01.04	92		JBH		0 986 480 699	23,8
			03.01-01.04	85		JBH		0 986 480 699	23,8	
	2.0 DT, DTI, DTL	OFD	03.98-01.05	60/74		JBH		0 986 480 699	23,8	
	2.0 DT, DTI, DTL, i, Turbo	MFD	09.97-01.05	60/74/100/118/141-147		JBH		0 986 481 028	23,81	
	2.0 i		10.99-12.01	100		JBH		0 986 480 699	23,8	
OFD		09.97-01.04	100		JBH		0 986 480 699	23,8		
2.0 i, Turbo	OFD	10.99-02.04	118/141-147		JBH		0 986 480 699	23,8		
2.2 DTI	MFD	09.00-01.04	92/108		JBH		0 986 481 028	23,81		
2.2 i	OFD	09.00-01.04	92/108		JBH		0 986 480 699	23,8		

		S							
	1.2 i	09.97-09.03	48/55			LLE	0 986 486 068		
	1.4 i, Twinport	09.97-06.09	66			LLE	0 986 486 068		
	1.6 i, i Twinport	09.97-07.09	55/62/74/76			LLE	0 986 486 068		
	1.7 CDTI, DT, DTI	03.98-01.04	50/55/59			LLE	0 986 486 068		
	1.8 i	09.97-01.04	85/92			LLE	0 986 486 068		
	2.0 DT, DTI, DTL, i, Turbo	09.97-01.05	60/74/100/118/141-147			LLE	0 986 486 068		
	2.2 DTI, i	09.00-01.04	92/108			LLE	0 986 486 068		
	1.2 i	09.97-09.03	48/55			F13	0 986 486 588	31	
	1.4 i	09.97-01.04	66			F13	0 986 486 588	31	
	1.4 Twinport	09.03-06.09	66			TW	0 986 486 584	31	
							0 986 486 588	31	
	1.6 i	09.97-01.05	55/62/74			F13	0 986 486 588	31	
	1.6 i Twinport	03.03-07.09	76				0 986 486 588	31	
	1.7 CDTI, DT, DTI	03.98-01.04	50/55/59			F13	0 986 486 588	31	
	1.8 i	09.97-01.04	85/92			F13	0 986 486 588	31	
	2.0 DT, DTI, DTL, i	09.97-01.05	60/74/100			F18	0 986 486 593	34	
	2.0 i	10.99-09.02	118			F23	0 986 486 585	34	
		1.2 i	09.97-09.03	48	Fg.-Nr. →X2014819, →X5009355, →X6006066, →X8005679			0 265 216 474 ^B	
				Fg.-Nr. X2014820→, X5009356→, X6006067→, X8005680→			0 265 216 652 ^B		
		09.00-09.03	55				0 265 216 652 ^B		
1.4 i		09.97-09.00	66	Fg.-Nr. →X2014819, →X5009355, →X6006066, →X8005679			0 265 216 474 ^B		
				Fg.-Nr. X2014820→, X5009356→, X6006067→, X8005680→			0 265 216 652 ^B		
		09.00-01.04	66				0 265 216 652 ^B		
1.4 Twinport		09.03-06.09	66				0 265 216 652 ^B		
1.6 i		09.97-08.00	55	Fg.-Nr. →X2014819, →X5009355, →X6006066, →X8005679			0 265 216 474 ^B		
				Fg.-Nr. X2014820→, X5009356→, X6006067→, X8005680→			0 265 216 652 ^B		
		09.97-01.04	74	Fg.-Nr. →X2014819, →X5009355, →X6006066, →X8005679			0 265 216 474 ^B		
				Fg.-Nr. X2014820→, X5009356→, X6006067→, X8005680→			0 265 216 652 ^B		
		10.99-12.05	74				0 265 216 652 ^B		
		09.00-01.04	74	Fg.-Nr. →32035797, →35033917, →38004448			0 265 202 492 ^T		
		09.00-01.05	62				0 265 216 652 ^B		
1.6 i Twinport		03.03-07.09	76				0 265 202 509 ^T		
							0 265 216 652 ^B		
1.7 CDTI, DTI		09.00-01.04	55/59				0 265 216 652 ^B		
1.7 DT		03.98-08.00	50	Fg.-Nr. →X2014819, →X5009355, →X6006066, →X8005679			0 265 216 474 ^B		
				Fg.-Nr. X2014820→, X5009356→, X6006067→, X8005680→			0 265 216 652 ^B		
1.8 i		09.97-08.00	85				0 265 202 458 ^T		
			Fg.-Nr. →X2040738, →X5028417, →X6006066, →X8013993			0 265 220 450 ^F			
			Fg.-Nr. X2040739→, X5028418→, X6006067→, X8013994→			0 265 220 532 ^F			
	10.99-12.02	85				0 265 216 652 ^B			
	09.00-01.04	92	Fg.-Nr. →12999999, →15999999, →16999999, →18999999, →1B999999			0 265 220 585 ^B			
			Fg.-Nr. →32035797, →35033917, →38004448			0 265 202 492 ^T			
			Fg.-Nr. 22000001→, 25000001→, 26000001→, 28000001→			0 265 220 637 ^F			
			Fg.-Nr. 32035798→, 35033918→, 38004449→			0 265 202 509 ^T			



		S										
◀ OPEL Astra [G]												
	1.8 i	03.01-01.04	85	Fg.-Nr. →12999999, →15999999, →16999999, →18999999, →1B999999			0 265 220 585 ^B					
				Fg.-Nr. →32035797, →35033917, →38004448			0 265 202 492 ^T					
				Fg.-Nr. 22000001→, 25000001→, 26000001→, 28000001→			0 265 220 637 ^F					
				Fg.-Nr. 32035798→, 35033918→, 38004449→			0 265 202 509 ^T					
				01.03-12.05 92			0 265 220 637 ^F					
	2.0 DT	03.98-08.00	60	Fg.-Nr. →X2014819, →X5009355, →X6006066, →X8005679			0 265 216 474 ^B					
				Fg.-Nr. X2014820→, X5009356→, X6006067→, X8005680→			0 265 216 652 ^B					
	2.0 DTI	09.99-01.05	74	Fg.-Nr. 22000001→, 25000001→, 26000001→, 28000001→			0 265 216 652 ^B					
							0 265 220 637 ^F					
	2.0 DTL	09.00-01.04	60				0 265 216 652 ^B					
							0 265 216 652 ^B					
	2.0 i	09.97-01.04	100	Fg.-Nr. →X2040738, →X5028417, →X6006066, →X8013993			0 265 220 450 ^F					
				Fg.-Nr. X2040739→, X5028418→, X6006067→, X8013994→			0 265 220 532 ^F					
		10.99-12.01		100				0 265 216 652 ^B				
		10.99-09.02		118				0 265 220 532 ^F				
	2.0 Turbo	09.02-02.04	141-147	Fg.-Nr. →32035797, →35033917, →38004448			0 265 220 585 ^B					
				Fg.-Nr. 32035798→, 35033918→, 38004449→			0 265 202 492 ^T					
							0 265 202 509 ^T					
	2.2 DTI	09.01-01.04	92	Fg.-Nr. →32035797, →35033917, →38004448			0 265 220 637 ^F					
				Fg.-Nr. →32035797, →35033917, →38004448			0 265 202 492 ^T					
				Fg.-Nr. 32035798→, 35033918→, 38004449→			0 265 202 509 ^T					
	2.2 i	09.00-01.04	108	Fg.-Nr. →32035797, →35033917, →38004448			0 265 220 585 ^B					
				Fg.-Nr. 22000001→, 25000001→, 26000001→, 28000001→			0 265 202 492 ^T					
				Fg.-Nr. 22000001→, 25000001→, 26000001→, 28000001→			0 265 220 637 ^F					
				Fg.-Nr. 32035798→, 35033918→, 38004449→			0 265 202 509 ^T					
	1.6 i, i Twinport	09.00-07.09	74/76				0 265 005 262					
				09.97-01.04	85/92				0 265 005 262			
									0 265 005 262			
									0 265 005 262			
									0 265 005 262			
09.01-01.04	92	Fg.-Nr. 22000001→, 2B000001→, 2H000001→, 25000001→, 26000001→, 28000001→			0 265 005 262							
					0 265 005 262							
	1.6 i, i Twinport	09.00-07.09	74/76				0 265 005 435					
				09.97-08.00	85				0 265 005 435			
									0 265 005 435			
									0 265 005 435			
									0 265 005 435			
03.01-01.04	85	Fg.-Nr. 12000001→, 1H000001→, 22000001→, 25000001→, 26000001→, 28000001→, 2H000001→, 1B000001→			0 265 005 435							
					0 265 005 435							
	2.0 Turbo	09.02-02.04	141-147				0 265 005 435					
							0 265 005 435					
	2.2 DTI	09.00-01.04	92/108	Fg.-Nr. 12000001→, 1H000001→, 22000001→, 25000001→, 26000001→, 28000001→, 2H000001→, 1B000001→			0 265 005 435					
							0 265 005 435					
	1.6 i, i Twinport	09.00-07.09	74/76				0 265 005 303					
				09.97-01.04	85/92				0 265 005 303			

		S							
2.0 Turbo		09.02-02.04	141-147				0 265 005 303		
2.2 DTI, i		09.00-01.04	92/108				0 265 005 303		
Astra GTC [H]									
	1.3 CDTI	MFD 06.05-02.09	66	Fg.-Nr. →62999999, →65999999, →68999999	JBH,LLE, RLE		0 986 480 856	25,4	
				Fg.-Nr. 72000001→, 75000001→, 78000001→	LLE,RLE		0 986 481 059	25,4	
		OFD 06.05-02.09	66	Fg.-Nr. →62999999, →65999999, →68999999	JBH,LLE		0 986 480 880	25,4	
				Fg.-Nr. 72000001→, 75000001→, 78000001→	LLE		0 986 481 058	25,4	
	1.4 Twinport	MFD 03.05-03.09	55/66	Fg.-Nr. →62999999, →65999999, →68999999	JBH,LLE, RLE		0 986 480 856	25,4	
				Fg.-Nr. 72000001→, 75000001→, 78000001→	LLE,RLE		0 986 481 059	25,4	
		OFD 03.05-03.09	55/66	Fg.-Nr. →62999999, →65999999, →68999999	JBH,LLE		0 986 480 880	25,4	
				Fg.-Nr. 72000001→, 75000001→, 78000001→	LLE		0 986 481 058	25,4	
	1.6 i	MFD 12.06-09.09	85	Fg.-Nr. →62999999, →65999999, →68999999	JBH,LLE, RLE		0 986 480 856	25,4	
				Fg.-Nr. 72000001→, 75000001→, 78000001→	LLE,RLE		0 986 481 059	25,4	
		01.11-12.12	85				0 986 481 059	25,4	
	1.6 i, Turbo	01.11-12.12	85/132		TW		0 986 481 058	25,4	
	1.6 i	OFD 03.05-09.09	77/85	Fg.-Nr. →62999999, →65999999, →68999999	JBH,LLE		0 986 480 880	25,4	
	1.6 Twinport			Fg.-Nr. 72000001→, 75000001→, 78000001→	LLE		0 986 481 058	25,4	
	1.6 Turbo	MFD 02.07-09.10	132	Fg.-Nr. →62999999, →65999999, →68999999, →6G999999	JBH		0 986 480 856	25,4	
				Fg.-Nr. 72000001→, 75000001→, 78000001→, 7G000001→, 8B000001→			0 986 481 059	25,4	
		01.11-12.12	132				0 986 481 059	25,4	
		OFD 02.07-09.10	132	Fg.-Nr. →62999999, →65999999, →68999999, →6G999999	JBH		0 986 480 880	25,4	
				Fg.-Nr. 72000001→, 75000001→, 78000001→, 7G000001→, 8B000001→			0 986 481 058	25,4	
	1.6 Twinport	MFD 03.05-03.08	77	Fg.-Nr. →62999999, →65999999, →68999999	JBH,LLE, RLE		0 986 480 856	25,4	
				Fg.-Nr. 72000001→, 75000001→, 78000001→	LLE,RLE		0 986 481 059	25,4	
	1.7 CDTI	10.09-12.12	81		TW		0 986 481 058	25,4	
							0 986 481 059	25,4	
		MFD 03.05-09.09	59/74/81/ 92	Fg.-Nr. →62999999, →65999999, →68999999	JBH,LLE, RLE		0 986 480 856	25,4	
				Fg.-Nr. 72000001→, 75000001→, 78000001→	LLE,RLE		0 986 481 059	25,4	
		OFD 03.05-09.09	59/74/81/ 92	Fg.-Nr. →62999999, →65999999, →68999999	JBH,LLE		0 986 480 880	25,4	
				Fg.-Nr. 72000001→, 75000001→, 78000001→	LLE		0 986 481 058	25,4	





◀ OPEL Astra GTC [H]

	1.8 i	01.11-12.12	103		TW	0986 481 058	25,4	
		MFD 03.05-03.08	92	Fg.-Nr. →62999999, →65999999, →68999999	JBH,LLE, RLE	0986 480 856	25,4	
				Fg.-Nr. 72000001→, 75000001→, 78000001→	LLE,RLE	0986 481 059	25,4	
		11.07-12.10	103	Fg.-Nr. →62999999, →65999999, →68999999, →6G999999	JBH	0986 480 856	25,4	
				Fg.-Nr. 72000001→, 75000001→, 78000001→, 7G000001→, 8B000001→		0986 481 059	25,4	
		01.11-12.12	103			0986 481 059	25,4	
		OFD 03.05-03.08	92	Fg.-Nr. →62999999, →65999999, →68999999	JBH,LLE	0986 480 880	25,4	
				Fg.-Nr. 72000001→, 75000001→, 78000001→	LLE	0986 481 058	25,4	
		11.07-12.10	103	Fg.-Nr. →62999999, →65999999, →68999999, →6G999999	JBH	0986 480 880	25,4	
				Fg.-Nr. 72000001→, 75000001→, 78000001→, 7G000001→, 8B000001→		0986 481 058	25,4	
		2.0 Turbo	MFD 03.05-09.09	125/147/ 177	Fg.-Nr. →62999999, →65999999, →68999999	JBH,LLE, RLE	0986 480 856	25,4
					Fg.-Nr. 72000001→, 75000001→, 78000001→	LLE,RLE	0986 481 059	25,4
OFD 03.05-09.09	125/147/ 177		Fg.-Nr. →62999999, →65999999, →68999999	JBH,LLE	0986 480 880	25,4		
			Fg.-Nr. 72000001→, 75000001→, 78000001→	LLE	0986 481 058	25,4		
	1.3 CDTI	06.05-02.09	66		LLE	0986 486 068		
	1.4 Twinport	03.05-03.09	55/66		LLE	0986 486 068		
	1.6 i	12.06-09.09	85		LLE	0986 486 068		
		01.11-12.12	85		LLE	0986 486 068		
	1.6 Turbo	02.07-09.10	132		LLE	0986 486 068		
		01.11-12.12	132		LLE	0986 486 068		
	1.6 Twinport	03.05-03.08	77		LLE	0986 486 068		
	1.7 CDTI	03.05-12.12	59/74/81/92		LLE	0986 486 068		
	1.8 i	03.05-12.12	92/103		LLE	0986 486 068		
	1.9, CDTI	03.05-07.10	74/88/110		LLE	0986 486 068		
	2.0 Turbo	03.05-09.09	125/147/177		LLE	0986 486 068		
		1.3 CDTI	06.05-02.09	66		F13,TW	0986 486 588	31
					Get.-Nr. F13	TW	0986 486 584	31
					Get.-Nr. M20	EAY	0986 486 589	34
					Get.-Nr. M20, Get.-Nr. M32	GS	0986 486 591	34
		1.4 Twinport	03.05-03.09	55/66		F13,TW	0986 486 588	31
Get.-Nr. F13					TW	0986 486 584	31	
Get.-Nr. M20					EAY	0986 486 589	34	
					GS	0986 486 591	34	
1.6 i		12.06-09.09	85		F13,TW	0986 486 588	31	
				Get.-Nr. F13	TW	0986 486 584	31	
				Get.-Nr. M20	EAY	0986 486 589	34	
					GS	0986 486 591	34	
		01.11-12.12	85		F13,TW	0986 486 588	31	
				Get.-Nr. F13	GS,TW	0986 486 584	31	
				Get.-Nr. F13, Get.-Nr. F17	EAY,GS,TW	0986 486 588	31	
				Get.-Nr. M20	EAY,TW	0986 486 589	34	
1.6 Turbo		02.07-09.10	132		GS,TW	0986 486 591	34	
				Get.-Nr. F13	GS,TW	0986 486 584	31	
				Get.-Nr. F13, Get.-Nr. F17	EAY,GS,TW	0986 486 588	31	
				Get.-Nr. M20	EAY	0986 486 589	34	
				GS,TW	0986 486 591	34		
				MG6	0986 486 591	34		

		S								
1.6 Turbo	01.11-12.12	132	Get.-Nr. F13	GS,TW	0 986 486 584	31				
			Get.-Nr. F13, Get.-Nr. F17	EAY,GS,TW	0 986 486 588	31				
			Get.-Nr. M20	EAY,TW	0 986 486 589	34				
					GS,TW	0 986 486 591	34			
1.6 Twinport	03.05-03.08	77		F13,TW	0 986 486 588	31				
			Get.-Nr. F13	TW	0 986 486 584	31				
			Get.-Nr. M20	EAY	0 986 486 589	34				
				GS	0 986 486 591	34				
1.7 CDTI	03.05-03.07	59		F13,TW	0 986 486 588	31				
			Get.-Nr. F13	TW	0 986 486 584	31				
			Get.-Nr. M20	EAY	0 986 486 589	34				
				GS	0 986 486 591	34				
	09.05-03.07	74		F13,TW	0 986 486 588	31				
Get.-Nr. F13			TW	0 986 486 584	31					
Get.-Nr. M20			EAY	0 986 486 589	34					
			Get.-Nr. M20, Get.-Nr. M32	GS	0 986 486 591	34				
	02.07-03.09	92		F13,TW	0 986 486 588	31				
Get.-Nr. F13			TW	0 986 486 584	31					
Get.-Nr. M20			EAY	0 986 486 589	34					
				GS	0 986 486 591	34				
	02.07-09.09	81		F13,TW	0 986 486 588	31				
Get.-Nr. F13			TW	0 986 486 584	31					
Get.-Nr. M20			GS	0 986 486 591	34					
			Get.-Nr. M32		0 986 486 594	34				
	02.07-12.12	81	Get.-Nr. M20	EAY	0 986 486 589	34				
10.09-12.12			81	Get.-Nr. F13	MG5,TW	0 986 486 584	31			
				Get.-Nr. F13, Get.-Nr. F17	EAY,MG5,TW	0 986 486 588	31			
	Get.-Nr. M20	MG6,TW		0 986 486 591	34					
			Get.-Nr. M32	MG6,TW	0 986 486 594	34				
1.8 i	03.05-03.08	92		F13,TW	0 986 486 588	31				
			Get.-Nr. F13	TW	0 986 486 584	31				
			Get.-Nr. M20	EAY	0 986 486 589	34				
				GS	0 986 486 591	34				
	11.07-12.10	103	Get.-Nr. F13	MG5,TW	0 986 486 584	31				
Get.-Nr. F13, Get.-Nr. F17			EAY,MG5,TW	0 986 486 588	31					
Get.-Nr. M20			EAY	0 986 486 589	34					
				MG6	0 986 486 591	34				
	01.11-12.12	103	Get.-Nr. F13	GS,TW	0 986 486 584	31				
Get.-Nr. F13, Get.-Nr. F17			EAY,GS,TW	0 986 486 588	31					
Get.-Nr. M20			EAY,TW	0 986 486 589	34					
				GS,TW	0 986 486 591	34				
1.9	07.05-07.10	74	Get.-Nr. F13	MG5,TW	0 986 486 584	31				
			Get.-Nr. F13, Get.-Nr. F17	EAY,MG5,TW	0 986 486 588	31				
			Get.-Nr. M20	EAY	0 986 486 589	34				
				MG6,TW	0 986 486 591	34				
			Get.-Nr. M32	MG6,TW	0 986 486 590	34				
	88	88	Get.-Nr. F13	MG5,TW	0 986 486 584	31				
Get.-Nr. F13, Get.-Nr. F17			EAY,MG5,TW	0 986 486 588	31					
Get.-Nr. M20			MG6,TW	0 986 486 591	34					
			Get.-Nr. M32	MG6,TW	0 986 486 590	34				
1.9, CDTI	03.05-07.10	88	Get.-Nr. M20	EAY	0 986 486 589	34				
1.9 CDTI	03.05-03.08	88		F13,TW	0 986 486 588	31				
			Get.-Nr. F13	TW	0 986 486 584	31				
			Get.-Nr. M20	GS	0 986 486 591	34				
			Get.-Nr. M32		0 986 486 590	34				
	03.05-09.09	110		F13,TW	0 986 486 588	31				
Get.-Nr. F13			TW	0 986 486 584	31					
Get.-Nr. M20			EAY	0 986 486 589	34					
				GS	0 986 486 591	34				
			Get.-Nr. M32		0 986 486 590	34				



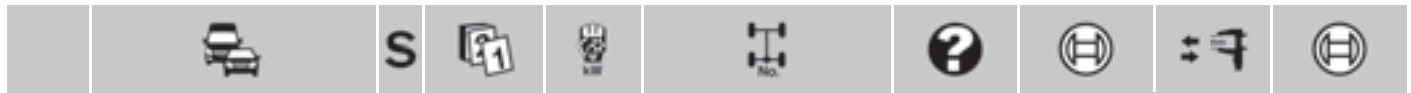

◀ OPEL Astra GTC [H]							
2.0 Turbo	03.05-09.09	125/147		F13,TW	0986	486 588	31
			Get.-Nr. F13	TW	0986	486 584	31
			Get.-Nr. M20	EAY	0986	486 589	34
			Get.-Nr. M20, Get.-Nr. M32	GS	0986	486 591	34
	08.05-03.09	177		F13,TW	0986	486 588	31
			Get.-Nr. F13	TW	0986	486 584	31
			Get.-Nr. M20	EAY	0986	486 589	34
				GS	0986	486 591	34
			Get.-Nr. M32		0986	486 590	34

Astra GTC [J]

1.4	09.11→	74	Get.-Nr. F17	TW	0986	486 588	31
	1.4 Turbo	09.11→	88/103	Get.-Nr. F17	TW	0986	486 588
			Get.-Nr. F17	MG5,TW	0986	486 588	31
1.6 Turbo	09.11→	132	Get.-Nr. F17	TW	0986	486 588	31
	04.13→	125		MG5,TW	0986	486 588	31
	09.13→	147	Get.-Nr. F17	MG5,TW	0986	486 588	31
1.7	11.11→	81/96	Get.-Nr. F17	TW	0986	486 588	31
1.8	11.11→	103	Get.-Nr. F17	TW	0986	486 588	31
2.0	09.11→	96/121/143	Get.-Nr. F17	TW	0986	486 588	31
2.0 Turbo	06.12→	206	Get.-Nr. F17	TW	0986	486 588	31
	03.15→	206	Get.-Nr. F17	MG5,TW	0986	486 588	31

Astra [H]

1.2 i Twinport	MFD	03.07-03.09	59	Fg.-Nr. →62999999, →65999999, →68999999	JBH,LLE, RLE	0986	480 856	25,4
				Fg.-Nr. 72000001→, 75000001→, 78000001→	LLE,RLE	0986	481 059	25,4
	OFD	03.07-03.09	59	Fg.-Nr. →62999999, →65999999, →68999999	JBH,LLE	0986	480 880	25,4
				Fg.-Nr. 72000001→, 75000001→, 78000001→	LLE	0986	481 058	25,4
1.3 CDTI	MFD	08.05-03.10	66	Fg.-Nr. →62999999, →65999999, →68999999	JBH,LLE, RLE	0986	480 856	25,4
				Fg.-Nr. 72000001→, 75000001→, 78000001→	LLE,RLE	0986	481 059	25,4
	OFD	08.05-03.10	66	Fg.-Nr. →62999999, →65999999, →68999999	JBH,LLE	0986	480 880	25,4
				Fg.-Nr. 72000001→, 75000001→, 78000001→	LLE	0986	481 058	25,4
1.4 i 1.4 Twinport	MFD	03.04-03.10	55/66	Fg.-Nr. →62999999, →65999999, →68999999	JBH,LLE, RLE	0986	480 856	25,4
				Fg.-Nr. 72000001→, 75000001→, 78000001→	LLE,RLE	0986	481 059	25,4
	OFD	03.04-03.10	55/66	Fg.-Nr. →62999999, →65999999, →68999999	JBH,LLE	0986	480 880	25,4
				Fg.-Nr. 72000001→, 75000001→, 78000001→	LLE	0986	481 058	25,4
1.6		07.10→	85		TW	0986	481 058	25,4
						0986	481 059	25,4
1.6, Turbo, Twinport	MFD	03.04-03.10	77/85/132	Fg.-Nr. →62999999, →65999999, →68999999	JBH,LLE, RLE	0986	480 856	25,4
				Fg.-Nr. 72000001→, 75000001→, 78000001→	LLE,RLE	0986	481 059	25,4
	OFD	03.04-03.10	77/85/132	Fg.-Nr. →62999999, →65999999, →68999999	JBH,LLE	0986	480 880	25,4
				Fg.-Nr. 72000001→, 75000001→, 78000001→	LLE	0986	481 058	25,4

		S							
1.7 CDTI		04.09→	92			TW		0 986 481 058	25,4
								0 986 481 059	25,4
	MFD	03.04-03.10	59/74/81/92	Fg.-Nr. →62999999, →65999999, →68999999	JBH,LLE, RLE	LLE,RLE		0 986 480 856	25,4
				Fg.-Nr. 72000001→, 75000001→, 78000001→				0 986 481 059	25,4
OFD	03.04-03.10	59/74/81/92	Fg.-Nr. →62999999, →65999999, →68999999	JBH,LLE	LLE		0 986 480 880	25,4	
			Fg.-Nr. 72000001→, 75000001→, 78000001→				0 986 481 058	25,4	
1.8		07.10→	103			TW		0 986 481 058	25,4
								0 986 481 059	25,4
1.8 i	MFD	03.04-03.10	92/103	Fg.-Nr. →62999999, →65999999, →68999999	JBH,LLE, RLE	LLE,RLE		0 986 480 856	25,4
				Fg.-Nr. 72000001→, 75000001→, 78000001→				0 986 481 059	25,4
	OFD	03.04-03.10	92/103	Fg.-Nr. →62999999, →65999999, →68999999	JBH,LLE	LLE		0 986 480 880	25,4
				Fg.-Nr. 72000001→, 75000001→, 78000001→				0 986 481 058	25,4
2.0 Turbo	MFD	03.04-03.10	125/147/177	Fg.-Nr. →62999999, →65999999, →68999999	JBH,LLE, RLE	LLE,RLE		0 986 480 856	25,4
				Fg.-Nr. 72000001→, 75000001→, 78000001→				0 986 481 059	25,4
	OFD	03.04-03.10	125/147/177	Fg.-Nr. →62999999, →65999999, →68999999	JBH,LLE	LLE		0 986 480 880	25,4
				Fg.-Nr. 72000001→, 75000001→, 78000001→				0 986 481 058	25,4
2.2 Direct	MFD	04.04-03.10	110	Fg.-Nr. →62999999, →65999999, →68999999, →6G999999	JBH			0 986 480 856	25,4
				Fg.-Nr. 72000001→, 75000001→, 78000001→, 7G000001→, 8B000001→				0 986 481 059	25,4
	OFD	04.04-03.10	110	Fg.-Nr. →62999999, →65999999, →68999999, →6G999999	JBH			0 986 480 880	25,4
				Fg.-Nr. 72000001→, 75000001→, 78000001→, 7G000001→, 8B000001→				0 986 481 058	25,4
	1.2 i Twinport	03.07-03.09	59			LLE		0 986 486 068	
	1.3 CDTI	08.05-03.10	66			LLE		0 986 486 068	
	1.4 i, Twinport	03.04-03.10	55/66			LLE		0 986 486 068	
	1.6	01.07-03.10	85			LLE		0 986 486 068	
		07.10→	85			LLE		0 986 486 068	
	1.6 Turbo	02.07-03.10	132			LLE		0 986 486 068	
	1.6 Twinport	03.04-03.09	77			LLE		0 986 486 068	
	1.7 CDTI	03.04-08.07	59/74			LLE		0 986 486 068	
		04.09→	92			LLE		0 986 486 068	
	1.8	07.10→	103			LLE		0 986 486 068	
	1.8 i	03.04-02.09	92			LLE		0 986 486 068	
		08.05-03.10	103			LLE		0 986 486 068	
	1.9 CDTI	04.04-03.10	74/88/110			LLE		0 986 486 068	
	2.0 Turbo	03.04-03.10	125/147/177			LLE		0 986 486 068	
	2.2 Direct	04.04-03.10	110			LLE		0 986 486 068	
		1.2 i Twinport	03.07-03.09	59	Get.-Nr. M20	EAY			0 986 486 589
1.3 CDTI		08.05-03.10	66		F13,TW			0 986 486 588	31
				Get.-Nr. F13	TW		0 986 486 584	31	
				Get.-Nr. M20	EAY		0 986 486 589	34	
				Get.-Nr. M20, Get.-Nr. M32	GS		0 986 486 591	34	

		S								
◀ OPEL Astra [H]										
1.4 i		03.04-03.10	55/66			F13,TW	0986 486 588	31		
1.4 Twinport				Get.-Nr. F13		TW	0986 486 584	31		
				Get.-Nr. M20		EAY	0986 486 589	34		
						GS	0986 486 591	34		
1.6		01.07-03.10	85			F13,TW	0986 486 588	31		
				Get.-Nr. F13		TW	0986 486 584	31		
				Get.-Nr. M20		EAY	0986 486 589	34		
						GS	0986 486 591	34		
		07.10→	85		Get.-Nr. F13		GS,TW	0986 486 584	31	
					Get.-Nr. F13, Get.-Nr. F17		EAY,GS,TW	0986 486 588	31	
1.6 Turbo		02.07-03.10	132			F13,TW	0986 486 588	31		
				Get.-Nr. F13		TW	0986 486 584	31		
				Get.-Nr. M20		EAY	0986 486 589	34		
				Get.-Nr. M20, Get.-Nr. M32		GS	0986 486 591	34		
1.6 Twinport		03.04-03.09	77			F13,TW	0986 486 588	31		
				Get.-Nr. F13		TW	0986 486 584	31		
				Get.-Nr. M20		EAY	0986 486 589	34		
						GS	0986 486 591	34		
1.7 CDTI		03.04-09.05	59			F13,TW	0986 486 588	31		
				Get.-Nr. F13		TW	0986 486 584	31		
				Get.-Nr. M20		EAY	0986 486 589	34		
						GS	0986 486 591	34		
		03.04-08.07	74			F13,TW	0986 486 588	31		
				Get.-Nr. F13		TW	0986 486 584	31		
				Get.-Nr. M20		EAY	0986 486 589	34		
				Get.-Nr. M20, Get.-Nr. M32		GS	0986 486 591	34		
		02.07-03.10	81			EAY	0986 486 588	31		
			92			EAY	0986 486 594	34		
						EAY	0986 486 588	31		
						EAY	0986 486 594	34		
1.8		04.09→	92	Get.-Nr. F13		MG5,TW	0986 486 584	31		
				Get.-Nr. F13, Get.-Nr. F17		EAY,MG5,TW	0986 486 588	31		
				Get.-Nr. M20		EAY	0986 486 589	34		
						MG6,TW	0986 486 591	34		
				Get.-Nr. M32		MG6,TW	0986 486 594	34		
		07.10→	103	Get.-Nr. F13		GS,TW	0986 486 584	31		
				Get.-Nr. F13, Get.-Nr. F17		EAY,GS,TW	0986 486 588	31		
				Get.-Nr. M20		EAY	0986 486 589	34		
1.8 i		03.04-02.09	92			F13,TW	0986 486 588	31		
				Get.-Nr. F13		TW	0986 486 584	31		
				Get.-Nr. M20		EAY	0986 486 589	34		
						GS	0986 486 591	34		
		08.05-03.10	103			F13,TW	0986 486 588	31		
				Get.-Nr. F13		TW	0986 486 584	31		
1.9 CDTI		04.04-03.10	88/110				0986 486 590	34		
		10.05-09.09	74	Get.-Nr. F13		MG5,TW	0986 486 584	31		
				Get.-Nr. F13, Get.-Nr. F17		EAY,MG5,TW	0986 486 588	31		
				Get.-Nr. M20		EAY	0986 486 589	34		
						MG6,TW	0986 486 591	34		
				Get.-Nr. M32		MG6,TW	0986 486 590	34		
2.0 Turbo		03.04-03.10	125/147/177				0986 486 588	31		
2.2 Direct		04.04-03.10	110	Get.-Nr. F13		MG5,TW	0986 486 584	31		
				Get.-Nr. F13, Get.-Nr. F17		EAY,MG5,TW	0986 486 588	31		
				Get.-Nr. M20		EAY,TW	0986 486 589	34		
					MG6	0986 486 591	34			



Astra [J]

	1.3 CDTI	09.09→	66-70	Get.-Nr. F17	TW	0 986 486 588	31
	1.4 , i, i Turbo, Turbo	09.09→	64/74/88/	Get.-Nr. F17	TW	0 986 486 588	31
	1.6 , CDTI, GTC, i, i Turbo, Turbo	09.09→	81/85/100/ 125/132	Get.-Nr. F17	TW	0 986 486 588	31
	1.7 CDTI	09.09→	81/92/96	Get.-Nr. F17	TW	0 986 486 588	31
		10.10→	74		MG5,TW	0 986 486 588	31
	2.0 CDTI	09.09→	118/121/ 143	Get.-Nr. F17	TW	0 986 486 588	31

Astra Limousine [J]

	1.6 CDTI	12.13→	81/100	Get.-Nr. F17	TW	0 986 486 588	31

Astra Sporte Tourer [J]

	1.4 i Turbo	03.15→	88	Get.-Nr. F17	MG5,TW	0 986 486 588	31

Astra Sports Tourer [J]

	1.3 CDTI	09.10→	67-70	Get.-Nr. F17	TW	0 986 486 588	31
	1.4 i Turbo	09.10→	103	Get.-Nr. F17	TW	0 986 486 588	31
		03.15→	103	Get.-Nr. F17	MG5,TW	0 986 486 588	31
	1.4 , i Turbo	09.10→	74/88	Get.-Nr. F17	TW	0 986 486 588	31
	1.6 CDTI	10.13→	100	Get.-Nr. F17	TW	0 986 486 588	31
		02.14→	81	Get.-Nr. F17	TW	0 986 486 588	31
	1.6 i	09.10→	85	Get.-Nr. F17	TW	0 986 486 588	31
		03.15→	85	Get.-Nr. F17	MG5,TW	0 986 486 588	31
	1.6 i Turbo	09.10→	132	Get.-Nr. F17	TW	0 986 486 588	31
	1.6 Turbo	04.13→	125	Get.-Nr. F17	TW	0 986 486 588	31
		03.15→	125	Get.-Nr. F17	MG5,TW	0 986 486 588	31
	1.7 CDTI	09.10→	81/92/96	Get.-Nr. F17	TW	0 986 486 588	31
		10.10→	74		MG5,TW	0 986 486 588	31
	2.0 CDTI	09.10→	118/121/ 143	Get.-Nr. F17	TW	0 986 486 588	31

Astra TwinTop [H]

	1.6 i	MFD 09.05-03.08	76-77	Fg.-Nr. →62999999, →65999999, →68999999	JBH,LLE, RLE	0 986 480 856	25,4
				Fg.-Nr. 72000001→, 75000001→, 78000001→	LLE,RLE	0 986 481 059	25,4
		01.07-10.10	85			0 986 481 059	25,4
				Fg.-Nr. →62999999, →65999999, →68999999, →6G999999	JBH	0 986 480 856	25,4
		OFD 09.05-03.08	76-77	Fg.-Nr. →62999999, →65999999, →68999999	JBH,LLE	0 986 480 880	25,4
				Fg.-Nr. 72000001→, 75000001→, 78000001→	LLE	0 986 481 058	25,4
		01.07-10.10	85			0 986 481 058	25,4
				Fg.-Nr. →62999999, →65999999, →68999999, →6G999999	JBH	0 986 480 880	25,4



		S							
	◀ OPEL Astra TwinTop [H]								
1.6 i Turbo	MFD	02.07-10.10	132	Fg.-Nr. →62999999, →65999999, →68999999, →6G999999	JBH		0986 480 856	25,4	
				Fg.-Nr. 72000001→, 75000001→, 78000001→, 7G000001→, 8B000001→			0986 481 059	25,4	
	OFD	02.07-10.10	132	Fg.-Nr. →62999999, →65999999, →68999999, →6G999999	JBH		0986 480 880	25,4	
				Fg.-Nr. 72000001→, 75000001→, 78000001→, 7G000001→, 8B000001→			0986 481 058	25,4	
1.6 Turbo	MFD	02.07-10.10	132				0986 481 059	25,4	
	OFD	02.07-10.10	132				0986 481 058	25,4	
1.8 i	MFD	09.05-10.10	103	Fg.-Nr. →62999999, →65999999, →68999999, →6G999999	JBH		0986 480 856	25,4	
				Fg.-Nr. 72000001→, 75000001→, 78000001→, 7G000001→, 8B000001→			0986 481 059	25,4	
	OFD	09.05-10.10	103	Fg.-Nr. →62999999, →65999999, →68999999, →6G999999	JBH		0986 480 880	25,4	
				Fg.-Nr. 72000001→, 75000001→, 78000001→, 7G000001→, 8B000001→			0986 481 058	25,4	
2.0 i Turbo	MFD	09.05-02.09	125	Fg.-Nr. →62999999, →65999999, →68999999	JBH,LLE, RLE		0986 480 856	25,4	
				Fg.-Nr. 72000001→, 75000001→, 78000001→	LLE,RLE		0986 481 059	25,4	
		09.05-10.10	147	Fg.-Nr. →62999999, →65999999, →68999999, →6G999999	JBH		0986 480 856	25,4	
				Fg.-Nr. 72000001→, 75000001→, 78000001→, 7G000001→, 8B000001→			0986 481 059	25,4	
	OFD	09.05-02.09	125	Fg.-Nr. →62999999, →65999999, →68999999	JBH,LLE		0986 480 880	25,4	
				Fg.-Nr. 72000001→, 75000001→, 78000001→	LLE		0986 481 058	25,4	
		09.05-10.10	147	Fg.-Nr. →62999999, →65999999, →68999999, →6G999999	JBH		0986 480 880	25,4	
				Fg.-Nr. 72000001→, 75000001→, 78000001→, 7G000001→, 8B000001→			0986 481 058	25,4	
	1.6 i, i Turbo, Turbo	09.05-10.10	76-77/85/132		LLE		0986 486 068		
	1.8 i	09.05-10.10	103		LLE		0986 486 068		
	1.9 CDTi	09.05-10.10	110		LLE		0986 486 068		
	2.0 i Turbo	09.05-10.10	125/147		LLE		0986 486 068		
	1.6 i	09.05-03.08	76-77		F13,TW		0986 486 588	31	
				Get.-Nr. F13	TW		0986 486 584	31	
				Get.-Nr. M20	EAY		0986 486 589	34	
	01.07-10.10	85		GS		0986 486 591	34		
				MG6		0986 486 591	34		
			Get.-Nr. F13	MG5,TW		0986 486 584	31		
			Get.-Nr. F13, Get.-Nr. F17	EAY,MG5,TW		0986 486 588	31		
			Get.-Nr. M20	EAY		0986 486 589	34		

		S							
1.6i Turbo	02.07-10.10	132	Get.-Nr. F13	MG5,TW	0 986 486 584	31			
			Get.-Nr. F13, Get.-Nr. F17	EAY, MG5, TW	0 986 486 588	31			
			Get.-Nr. M20	EAY	0 986 486 589	34			
1.6 Turbo	02.07-10.10	132	Get.-Nr. F13	GS, TW	0 986 486 584	31			
			Get.-Nr. F13, Get.-Nr. F17	EAY, GS, TW	0 986 486 588	31			
			Get.-Nr. M20	EAY, TW	0 986 486 589	34			
				GS, TW	0 986 486 591	34			
1.8i	09.05-10.10	103	Get.-Nr. F13	GS, TW	0 986 486 584	31			
				MG5, TW	0 986 486 584	31			
			Get.-Nr. F13, Get.-Nr. F17	EAY, GS, TW	0 986 486 588	31			
				EAY, MG5, TW	0 986 486 588	31			
			Get.-Nr. M20	EAY	0 986 486 589	34			
				EAY, TW	0 986 486 589	34			
1.9 CDTi	09.05-10.10	110	Get.-Nr. F13	MG5, TW	0 986 486 584	31			
			Get.-Nr. F13, Get.-Nr. F17	EAY, MG5, TW	0 986 486 588	31			
			Get.-Nr. M20	EAY	0 986 486 589	34			
				MG6, TW	0 986 486 591	34			
2.0i Turbo	09.05-02.09	125		F13, TW	0 986 486 588	31			
			Get.-Nr. F13	TW	0 986 486 584	31			
2.0i Turbo	09.05-10.10	147	Get.-Nr. M20	EAY	0 986 486 589	34			
			Get.-Nr. M20, Get.-Nr. M32	GS	0 986 486 591	34			
			Get.-Nr. F13	MG5, TW	0 986 486 584	31			
			Get.-Nr. F13, Get.-Nr. F17	EAY, MG5, TW	0 986 486 588	31			
			Get.-Nr. M20	EAY	0 986 486 589	34			
			Get.-Nr. M20, Get.-Nr. M32	MG6	0 986 486 591	34			

Calibra

	2.0i	06.90-03.97	85/100/110	DEL, JBH	0 986 480 129	22,2					
				JBH ATE	0 986 480 907	22					
				JBH ATE	0 986 480 758	23,8					
	2.5i V6	04.93-03.97	125	JBH, LLE ATE	0 986 480 758	23,8					
	2.0i	ABO 06.90-03.97	85/100/110	RLE ATE	0 986 485 109						
				2.0i Turbo	03.92-03.97	150	RLE ATE	0 986 485 109			
				2.5i V6	04.93-03.97	125	RLE ATE	0 986 485 109			
	2.0i	06.90-03.97	85/100/110/150	Fg.-Nr. L1000001→M1299999	AA	0 265 201 048 ^H					
				2.0i Turbo	Fg.-Nr. N1000001→T1001897		0 265 208 311 ^H				
				2.5i V6	04.93-03.97	125	Fg.-Nr. L1000001→M1299999	AA	0 265 201 048 ^H		
				Fg.-Nr. N1000001→T1001897		0 265 208 311 ^H					
	2.0i	06.90-03.97	85/110/150	Fg.-Nr. L1000001→M1299999	NAA	0 265 103 038 ^H					
				2.0i Turbo							

Campo Pick-Up [TF0]

	3.1 TD	10.95-08.97	80		0 204 123 508				
	2.3, i	09.91-09.96	65-72		0 986 486 036	19,05			
				2.5 TD	10.89-08.97	56	0 986 486 036	19,05	



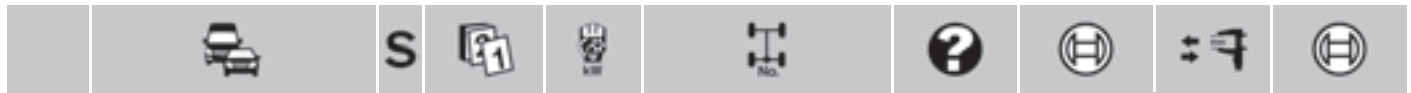

◀ OPEL

Combo



	1.2 i	ABO 09.94-10.01 33		JBH, LLE	0 986 480 130	20,6
		ABS 09.94-10.01 33		JBH, LLE	0 986 480 818	22
	1.4 i	ABO 09.94-10.01 44/60		JBH, LLE	0 986 480 130	20,6
		08.99-10.01 66		JBH, LLE	0 986 480 130	20,6
		08.08 → 66		JBH, LLE	0 986 480 130	20,6
		ABS 09.94-10.01 44/60		JBH, LLE	0 986 480 818	22
		08.99-10.01 66		JBH, LLE	0 986 480 818	22
		08.08 → 66		JBH, LLE	0 986 480 818	22
	1.7 D	ABO 09.94-10.01 44		JBH, LLE	0 986 480 130	20,6
		ABS 09.94-10.01 44		JBH, LLE	0 986 480 818	22

	1.2 i	09.94-10.01 33	Fg.-Nr. T3000001→	BO	0 265 216 410^B	
	1.4 i	09.94-10.01 44/60	Fg.-Nr. T3000001→	BO	0 265 216 410^B	
	1.7 D	09.94-10.01 44	Fg.-Nr. T3000001→	BO	0 265 216 410^B	

Combo [Tour]



	1.3 CDTI	ABO 09.04-09.07 51			0 204 123 662	22,2	
		10.05-01.12 55		TW	0 204 123 659	22,2	
					0 204 123 662	22,2	
		MFD 09.04-01.12 51/55		STB	0 204 123 639	22,2	
				4SB	0 204 123 637	23,8	
		OFD 09.04-01.12 51/55		STB	0 204 123 640	22,2	
				4SB	F 026 003 638	23,81	
		1.4 i Twinport	ABO 09.04-01.11 66		TW	0 204 123 659	22,2
					4SB, TW	0 204 123 662	22,2
			MFD 09.04-01.11 66		STB	0 204 123 639	22,2
					4SB	0 204 123 637	23,8
			OFD 09.04-01.11 66		STB	0 204 123 640	22,2
			4SB	F 026 003 638	23,81		
1.6 CNG	ABO 04.05-05.06 71	Fg.-Nr. 43000001→			0 204 123 662	22,2	
		Fg.-Nr. 43000001→, 44000001→, 46000001→	STB		0 204 123 659	22,2	
		Fg.-Nr. 44000001→, 46000001→	STB		0 204 123 659	22,2	
	06.06-01.11 69		TW		0 204 123 659	22,2	
					0 204 123 662	22,2	
	ABS 06.06-01.11 69				F 026 003 638	23,81	
	MFD 04.05-05.06 71	Fg.-Nr. 43000001→, 44000001→, 46000001→	STB		0 204 123 637	23,8	
	OFD 04.05-05.06 71	Fg.-Nr. 43000001→, 44000001→, 46000001→	STB		F 026 003 638	23,81	
				0 204 123 640	22,2		
1.6 i	10.01-08.04 64		DEL, JBH	0 986 480 859	22		
1.7 CDTI	ABO 09.04-01.11 74		TW		0 204 123 659	22,2	
					0 204 123 662	22,2	
	MFD 09.04-01.11 74		STB		0 204 123 639	22,2	
			4SB		0 204 123 637	23,8	
	OFD 09.04-01.11 74		STB		0 204 123 640	22,2	
			4SB		F 026 003 638	23,81	
1.7 DI, DTI	10.01-08.04 48/55		DEL, JBH	0 986 480 859	22		

	1.3 CDTI	10.05-01.12 55		4SB, TW	0 204 125 812		
					0 204 777 301		
		ABO 09.04-09.07 51				0 204 125 812	
		10.05-01.12 55		STB		0 204 125 812	
		ABS 09.04-09.07 51				0 204 125 813	
		10.05-01.12 55		STB, TW		0 204 125 813	
				0 204 777 297			

		S							
1.4i Twinport		09.04-01.11	66			4SB,TW	0 204 125 812		
							0 204 777 301		
	ABO	09.04-01.11	66			STB	0 204 125 812		
	ABS	09.04-01.11	66			STB,TW	0 204 125 813		
1.6 CNG		04.05-05.06	71			Fg.-Nr. 43000001→, 44000001→,46000001→	0 204 125 812		
		06.06-01.11	69				0 204 125 812		
	ABS	04.05-05.06	71			Fg.-Nr. 43000001→, 44000001→,46000001→	0 204 125 813		
		06.06-01.11	69				0 204 777 301		
1.6i	ABO	10.01-08.04	64			Fg.-Nr. 43000001→, 44000001→,46000001→	0 204 125 812		
	ABS	10.01-08.04	64			Fg.-Nr. 43000001→, 44000001→,46000001→	0 204 125 813		
1.7 CDTI		09.04-01.11	74			4SB	0 204 125 812		
	ABO	09.04-01.11	74			STB	0 204 125 812		
	ABS	09.04-01.11	74			STB	0 204 125 813		
1.7 DI	ABO	10.01-08.04	48/55			Fg.-Nr. 43000001→, 44000001→,46000001→	0 204 125 812		
1.7 DTI	ABS	10.01-08.04	48/55			Fg.-Nr. 43000001→, 44000001→,46000001→	0 204 125 813		
	1.3 CDTI	09.04-01.12	51/55				0 986 486 588	31	
	1.4i Twinport	09.04-01.11	66			EAY	0 986 486 588	31	
						GS	0 986 486 584	31	
	1.6 CNG	04.05-01.11	69/71				0 986 486 588	31	
	1.6i	10.01-08.04	64				0 986 486 588	31	
	1.7 DI, DTI	10.01-08.04	48/55				0 986 486 588	31	
	1.3 CDTI	09.04-09.07	51			EAY	0 265 231 444 ^B		
						GS	0 265 231 307 ^B		
						Fg.-Nr. →43999999, →44999999, →46999999			
						GS	0 265 232 213 ^B		
						Fg.-Nr. 53000001→, 54000001→,56000001→			
		10.05-01.12	55				0 265 232 213 ^B		
	1.4i Twinport	09.04-01.11	66				0 265 234 340 ^T		
						Fg.-Nr. 5300000→, 54000001→,56000001→	GS	0 265 232 213 ^B	
	1.6 CNG	04.05-05.06	71			Fg.-Nr. 53000001→, 54000001→,56000001→		0 265 232 213 ^B	
		06.06-01.11	69					0 265 232 213 ^B	
1.6i	10.01-08.04	64			Fg.-Nr. →43999999, →44999999, →46999999	GS	0 265 231 307 ^B		
1.7 CDTI	09.04-01.11	74					0 265 234 340 ^T		
					Fg.-Nr. 54000001→, 56000001→		0 265 232 215 ^B		
1.7 DI	10.01-08.04	48/55			Fg.-Nr. →43999999, →44999999, →46999999	GS	0 265 231 307 ^B		
1.7 DTI									
	1.6 CNG	04.05-05.06	71				0 265 005 303		
Corsa									
	1.4i	10.02-12.06	66			DEL,JBH	0 986 480 859	22	
	1.4i	10.02-12.06	66				1 273 004 227 ^H		

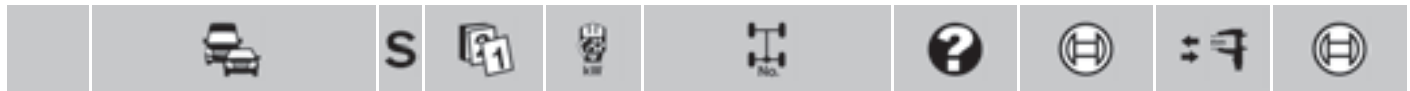

◀ OPEL

Corsa [A]



	1.0 S	09.82-08.94	33		JBH,K04	0986 480 095	20,64				
					JBH,K05	0986 480 496	20,64				
					JBH,K08	0986 480 483	20,64				
					Fg.-Nr. →J4999999	JBH,K06	0986 480 095	20,64			
						JBH,K11	0986 480 616	20,64			
					Fg.-Nr. K4000001→	B05,JBH	0986 480 128	20,6			
						JBH,K16	0986 480 116	20,64			
						JBH,K07	0986 480 117	20,64			
						Fg.-Nr. K4000001→	JBH,K16	0986 480 116	20,64		
							JBH,K08	0986 480 483	20,64		
						Fg.-Nr. →J4999999	JBH,K11	0986 480 616	20,64		
							JBH,K07	0986 480 117	20,64		
						Fg.-Nr. K4000001→	JBH,K16	0986 480 116	20,64		
						09.85-08.94	51	Fg.-Nr. →J4999999	JBH,K11	0986 480 616	20,64
								JBH,K16	0986 480 116	20,64	
	1.4	01.90-08.94	40-44/53/60	Fg.-Nr. K4000001→	JBH,K16	0986 480 116	20,64				
	1.4 i										
	1.5 D	09.87-08.94	37/49		JBH,K07	0986 480 117	20,64				
	1.5 TD			Fg.-Nr. →J4999999	JBH,K11	0986 480 616	20,64				
				Fg.-Nr. K4000001→	JBH,K16	0986 480 116	20,64				
	1.6 i	05.88-08.94	74		JBH,K07	0986 480 117	20,64				
				Fg.-Nr. →J4999999	JBH,K11	0986 480 616	20,64				
				Fg.-Nr. K4000001→	JBH,K16	0986 480 116	20,64				
		04.89-08.94	55	Fg.-Nr. →J4999999	JBH,K11	0986 480 616	20,64				
				Fg.-Nr. K4000001→	JBH,K16	0986 480 116	20,64				

	1.0 S	09.82-08.94	33		B01,B02	0986 485 006	
	1.2, i	01.87-08.94	33		B02	0986 485 006	
	1.2, S	09.82-08.94	37-44		B01,B02	0986 485 006	
	1.3 S	09.82-08.94	51		B01,B02	0986 485 006	
	1.4, i	01.90-08.94	40-44/53		B02	0986 485 006	
	1.4 i	09.91-08.94	60			0986 485 009	
	1.5 D, TD	09.87-08.94	37/49			0986 485 009	
	1.6 i	05.88-08.94	55/74			0986 485 009	

Corsa [B]



	1.0 i	ABo	09.96-09.00	40		JBH,LLE	0986 480 130	20,6
		ABS	09.96-09.00	40		JBH,LLE	0986 480 818	22
	1.2 i	ABo	03.93-08.00	33/48		JBH,LLE	0986 480 130	20,6
		ABS	03.93-08.00	33/48		JBH,LLE	0986 480 818	22
	1.4 i		10.02-12.03	65		DEL,JBH	0986 480 859	22
		ABo	03.93-09.00	44/60/63/66		JBH,LLE	0986 480 130	20,6
		ABS	03.93-09.00	44/60/63/66		JBH,LLE	0986 480 818	22
	1.5 D, TD, XD, XTD	ABo	03.93-08.00	37/49		JBH,LLE	0986 480 130	20,6
		ABS	03.93-08.00	37/49		JBH,LLE	0986 480 818	22
	1.6 GSi, i, i GSi	ABo	03.93-08.00	74/78/80		JBH,LLE	0986 480 130	20,6
		ABS	03.93-08.00	74/78/80		JBH,LLE	0986 480 818	22
	1.7 D	ABo	03.93-08.00	44		JBH,LLE	0986 480 130	20,6
ABS		03.93-08.00	44		JBH,LLE	0986 480 818	22	

	1.0 i	09.96-09.00	40	Fg.-Nr. T3000001→	BO	0265 216 410^B		
	1.2 i	03.93-08.00	33/48	Fg.-Nr. T3000001→	BO	0265 216 410^B		
	1.4 i	03.93-09.00	44/60/63/66	Fg.-Nr. T3000001→		BO	0265 216 410^B	
	1.5 D, TD, XD, XTD	03.93-08.00	37/49	Fg.-Nr. T3000001→	BO	0265 216 410^B		
1.6 GSi, i, i GSi	03.93-08.00	74/78/80	Fg.-Nr. T3000001→	BO	0265 216 410^B			
1.7 D	03.93-08.00	44	Fg.-Nr. T3000001→	BO	0265 216 410^B			



	1.4 i		10.02-12.03	65			1 273 004 227^H	
--	--------------	--	-------------	----	--	--	----------------------------------	--

Corsa [C]



	1.0 i 12V		09.00-08.03	43		DEL,JBH	0 986 480 859	22
	1.0 Twinport	MFD	09.03-09.06	44		STB	0 204 123 639	22,2
						4SB	0 204 123 637	23,8
		OFD	09.03-09.06	44		STB	0 204 123 640	22,2
						4SB	F 026 003 638	23,81
	1.2 i Twinport	MFD	07.04-09.06	59		STB	0 204 123 639	22,2
						4SB	0 204 123 637	23,8
		OFD	07.04-09.06	59		STB	0 204 123 640	22,2
						4SB	F 026 003 638	23,81
	1.2 i 16V		09.00-06.04	55	Fg.-Nr. →33999999, →34999999, →36999999	DEL,JBH	0 986 480 859	22
		MFD	09.00-06.04	55	Fg.-Nr. 34000001→, 44000001→, 46000001→	STB	0 204 123 637	23,8
						STB	0 204 123 639	22,2
		OFD	09.00-06.04	55	Fg.-Nr. 34000001→, 44000001→, 46000001→	STB	F 026 003 638	23,81
						STB	0 204 123 640	22,2
	1.3 CDTI	MFD	09.03-09.06	51/55		STB	0 204 123 639	22,2
						4SB	0 204 123 637	23,8
		OFD	09.03-09.06	51/55		STB	0 204 123 640	22,2
						4SB	F 026 003 638	23,81
	1.4 i Utility		10.08-06.10	66		DEL,JBH	0 986 480 859	22
	1.4 i 16V		09.00-08.03	66		DEL,JBH	0 986 480 859	22
	1.4 Twinport	MFD	09.03-09.06	66		STB	0 204 123 639	22,2
						4SB	0 204 123 637	23,8
		OFD	09.03-09.06	66		STB	0 204 123 640	22,2
						4SB	F 026 003 638	23,81
	1.6 i		09.01-08.05	62	Fg.-Nr. →33999999, →34999999, →36999999	DEL,JBH	0 986 480 859	22
		MFD	09.01-08.05	62	Fg.-Nr. 34000001→, 44000001→, 46000001→	STB	0 204 123 637	23,8
						STB	0 204 123 639	22,2
		OFD	09.01-08.05	62	Fg.-Nr. 34000001→, 44000001→, 46000001→	STB	0 204 123 640	22,2
						STB	0 204 123 640	22,2
	1.7 CDTI	MFD	09.03-09.06	74		STB	0 204 123 639	22,2
						4SB	0 204 123 637	23,8
		OFD	09.03-09.06	74		STB	0 204 123 640	22,2
						4SB	F 026 003 638	23,81
	1.7 DI		09.00-08.03	48	Fg.-Nr. →33999999, →34999999, →36999999	DEL,JBH	0 986 480 859	22
	1.7 DI	MFD	09.00-08.03	48/55	Fg.-Nr. 34000001→, 44000001→, 46000001→	STB	0 204 123 637	23,8
	1.7 DTI					STB	0 204 123 639	22,2
		OFD	09.00-08.03	48/55	Fg.-Nr. 34000001→, 44000001→, 46000001→	STB	F 026 003 638	23,81
						STB	0 204 123 640	22,2
	1.7 DTi		10.02-12.05	55		DEL,JBH	0 986 480 859	22
	1.7 DTI		09.00-08.03	55	Fg.-Nr. →33999999, →34999999, →36999999	DEL,JBH	0 986 480 859	22
	1.8 i Utility		10.02-06.10	79		DEL,JBH	0 986 480 859	22
	1.8 i 16V	MFD	09.01-08.05	92	Fg.-Nr. 34000001→, 44000001→, 46000001→	STB	0 204 123 637	23,8
						STB	0 204 123 639	22,2
		OFD	09.01-08.05	92	Fg.-Nr. 34000001→, 44000001→, 46000001→	STB	F 026 003 638	23,81
						STB	0 204 123 640	22,2

	1.0 Twinport	ABO	09.03-09.06	44	Fg.-Nr. 43000001→, 44000001→, 46000001→		0 204 125 812	
		ABS	09.03-09.06	44	Fg.-Nr. 43000001→, 44000001→, 46000001→		0 204 125 813	
	1.2 i Twinport	ABO	09.00-09.06	55/59	Fg.-Nr. 43000001→, 44000001→, 46000001→		0 204 125 812	
	1.2 i 16V							

		S							
◀ OPEL Corsa [C]									
1.2 i Twinport	ABS	09.00-09.06	55/59	Fg.-Nr. 43000001→, 44000001→, 46000001→			0 204 125 813		
1.2 i 16V									
1.3 CDTI	ABO	09.03-09.06	51/55	Fg.-Nr. 43000001→, 44000001→, 46000001→			0 204 125 812		
	ABS	09.03-09.06	51/55	Fg.-Nr. 43000001→, 44000001→, 46000001→			0 204 125 813		
1.4 Twinport	ABO	09.03-09.06	66	Fg.-Nr. 43000001→, 44000001→, 46000001→			0 204 125 812		
	ABS	09.03-09.06	66	Fg.-Nr. 43000001→, 44000001→, 46000001→			0 204 125 813		
1.6 i	ABO	09.01-08.05	62	Fg.-Nr. 43000001→, 44000001→, 46000001→			0 204 125 812		
	ABS	09.01-08.05	62	Fg.-Nr. 43000001→, 44000001→, 46000001→			0 204 125 813		
1.7 CDTI, DI, DTI	ABO	09.00-09.06	48/55/74	Fg.-Nr. 43000001→, 44000001→, 46000001→			0 204 125 812		
	ABS	09.00-09.06	48/55/74	Fg.-Nr. 43000001→, 44000001→, 46000001→			0 204 125 813		
1.8 i Utility		01.02-06.10	79				0 204 125 812		
	1.0 i 12V		09.00-09.06	43/44	EAY		0 986 486 588	31	
	1.0 Twinport				GS		0 986 486 584	31	
	1.2 i Twinport		09.00-09.06	55/59	EAY		0 986 486 588	31	
	1.2 i 16V				GS		0 986 486 584	31	
	1.3 CDTI		09.03-09.06	51/55			0 986 486 588	31	
	1.4 i 16V		09.00-08.03	66			0 986 486 584	31	
	1.4 Twinport		09.03-09.06	66	EAY		0 986 486 588	31	
					GS		0 986 486 584	31	
	1.6 i		09.01-08.05	62			0 986 486 588	31	
	1.7 DI		09.00-08.03	48			0 986 486 584	31	
	1.7 DTI		09.00-08.03	55			0 986 486 588	31	
	1.8 i 16V		09.01-08.05	92			0 986 486 588	31	
	1.4 i 16V		09.00-08.03	66			0 204 031 108 ^A		
	1.7 DI, DTI		09.00-08.03	48/55			0 204 031 108 ^A		
	1.0 i 12V		09.00-08.03	43	STB		0 265 216 479 ^B		
	1.0 Twinport		09.03-09.06	44			0 265 231 307 ^B		
							0 265 234 340 ^T		
	1.2 i Twinport		07.04-09.06	59			0 265 234 340 ^T		
					Fg.-Nr. 53000001→, 54000001→, 56000001→	GS	0 265 232 213 ^B		
	1.2 i 16V		09.00-06.04	55	Fg.-Nr. →33999999, →34999999, →36999999	STB	0 265 216 479 ^B		
					Fg.-Nr. 43000001→, 44000001→, 46000001→	STB	0 265 216 479 ^B		
	1.3 CDTI		09.03-09.06	51			0 265 231 307 ^B		
							0 265 234 340 ^T		
			09.05-09.06	55	Fg.-Nr. 53000001→, 54000001→, 56000001→		0 265 232 213 ^B		
	1.4 i 16V		09.00-08.03	66		STB	0 265 216 479 ^B		
	1.4 Twinport		09.03-09.06	66			0 265 231 307 ^B		
							0 265 234 340 ^T		
	1.6 i		09.01-08.05	62			0 265 234 340 ^T		
					Fg.-Nr. →33999999, →34999999, →36999999	STB	0 265 216 479 ^B		
					Fg.-Nr. 43000001→, 44000001→, 46000001→		0 265 231 307 ^B		
	1.7 CDTI		09.03-09.06	74			0 265 231 444 ^B		
							0 265 234 340 ^T		
	1.7 DI		09.00-08.03	48/55	Fg.-Nr. →33999999, →34999999, →36999999	STB	0 265 216 479 ^B		
	1.7 DTI								

		S							
	1.8 i Utility	01.02-06.10	79						0 265 216 479 ^B
	1.8 i 16V	09.01-08.05	92						0 265 234 340 ^T
						Fg.-Nr. →33999999, →34999999, →36999999			0 265 220 659 ^F
						Fg.-Nr. 54000001→, 56000001→			0 265 232 215 ^B
	1.8 i Utility	10.02-06.10	79						1 273 004 227 ^H
	1.0 Twinport	09.03-09.06	44						0 265 005 270
	1.2 i Twinport, i 16V	09.00-09.06	55/59						0 265 005 270
	1.3 CDTI	09.03-09.06	51						0 265 005 270
	1.4 Twinport	09.03-09.06	66						0 265 005 270
	1.6 i	09.01-08.05	62						0 265 005 270
	1.7 CDTI	09.03-09.06	74						0 265 005 270
	1.8 i 16V	09.01-08.05	92						0 265 005 270
	1.0 Twinport	09.03-09.06	44						0 265 005 303
	1.2 i Twinport	07.04-09.06	59						0 265 005 303
	1.3 CDTI	09.03-09.06	51/55						0 265 005 303
	1.4 Twinport	09.03-09.06	66						0 265 005 303
	1.6 i	09.01-08.05	62						0 265 005 303
	1.7 CDTI, DI, DTI	09.00-09.06	48/55/74						0 265 005 303
	1.8 i 16V	09.01-08.05	92						0 265 005 303
Corsa [D]									
	1.0 Twinport	MFD 07.06-10.09	44			LLE		0 204 123 739	22,2
						RLE		0 204 123 743	22,2
		12.09→	48			LLE		0 204 123 739	22,2
						RLE		0 204 123 743	22,2
		OFD 07.06-10.09	44			LLE		0 204 123 738	22,2
						RLE		0 204 123 742	22,2
		12.09→	48			LLE		0 204 123 738	22,2
						RLE		0 204 123 742	22,2
	1.2 LPG	MFD 07.06→	51/57/59/			LLE		0 204 123 739	22,2
	1.2 Twinport		63			RLE		0 204 123 743	22,2
		OFD 07.06→	51/57/59/			LLE		0 204 123 738	22,2
			63			RLE		0 204 123 742	22,2
	1.3 CDTI	MFD 07.06→	55/66/70			LLE		0 204 123 739	22,2
						RLE		0 204 123 743	22,2
		OFD 07.06→	55/66/70			LLE		0 204 123 738	22,2
						RLE		0 204 123 742	22,2
	1.4 LPG	MFD 07.06→	64/66/74			LLE		0 204 123 739	22,2
	1.4 Twinport					RLE		0 204 123 743	22,2
		OFD 07.06→	64/66/74			LLE		0 204 123 738	22,2
						RLE		0 204 123 742	22,2
	1.4 Twinport Turbo	MFD 07.12→	88			LLE		0 204 123 740	23,81
						RLE		0 204 123 744	23,81
		OFD 07.12→	88			LLE		0 204 123 741	23,81
						RLE		0 204 123 745	23,81
	1.6 i OPC Turbo	MFD 02.07→	110/141/			LLE		0 204 123 740	23,81
	1.6 i Turbo		155			RLE		0 204 123 744	23,81
		OFD 02.07→	110/141/			LLE		0 204 123 741	23,81
			155			RLE		0 204 123 745	23,81
	1.7 CDTI	MFD 07.06→	92/96			LLE		0 204 123 740	23,81
						RLE		0 204 123 744	23,81
		OFD 07.06→	92/96			LLE		0 204 123 741	23,81
						RLE		0 204 123 745	23,81



◀ OPEL Corsa [D]

	1.0 Twinport	MFD 07.06-10.09	44	LLE	0 204 125 870			
		12.09→	48	LLE	0 204 125 870			
		OFD 07.06-10.09	44	LLE,TW	0 204 125 870			
				RLE,TW	0 204 776 113			
		12.09→	48	LLE,TW	0 204 125 870			
				RLE,TW	0 204 776 113			
	1.2 LPG	MFD 09.09-12.11	57	LLE	0 204 125 870			
		OFD 09.09-12.11	57	LLE,TW	0 204 125 870			
	1.2 Twinport	MFD 07.06-12.11	59	LLE	0 204 125 870			
			12.09→	51	LLE	0 204 125 870		
			63	LLE	0 204 125 870			
			OFD 07.06-12.11	59	LLE,TW	0 204 125 870		
				RLE,TW	0 204 776 113			
12.09→			51	LLE,TW	0 204 125 870			
63			LLE,TW	0 204 776 113				
			LLE,TW	0 204 125 870				
			LLE,TW	0 204 776 113				
			LLE,TW	0 204 125 870				
			LLE,TW	0 204 776 113				
			LLE,TW	0 204 125 870				
1.3 CDTI	07.06-06.10	55	LLE,TW	0 204 125 870				
			RLE,TW	0 204 776 113				
	07.06-07.10	66	LLE	0 204 125 870				
		12.09→	70	LLE,TW	0 204 125 870			
			RLE,TW	0 204 776 113				
	01.11→	55	LLE,TW	0 204 125 870				
		RLE,TW	0 204 776 113					
1.4 LPG	MFD 09.09-11.10	64	LLE	0 204 125 870				
	OFD 09.09-11.10	64	LLE,TW	0 204 125 870				
1.4 LPG	OFD 09.09→	64	LLE,TW	0 204 776 113				
1.4 Twinport			RLE,TW	0 204 776 113				
1.4 Twinport	MFD 07.06-11.10	66	LLE	0 204 125 870				
		12.09→	64	LLE	0 204 125 870			
		74	LLE	0 204 125 870				
	OFD 07.06-11.10	66	LLE,TW	0 204 125 870				
				RLE,TW	0 204 776 113			
		12.09→	64	LLE,TW	0 204 125 870			
			LLE,TW	0 204 125 870				
			RLE,TW	0 204 776 113				
1.4 Twinport Turbo	07.12→	88	LLE	0 204 125 869				
1.6 i OPC Turbo, i Turbo	02.07→	110/141/155	LLE	0 204 125 869				
1.7 CDTI	07.06→	92/96	LLE	0 204 125 869				
	1.0 Twinport	07.06-10.09	44	Get.-Nr. F13	GS	0 986 486 584	31	
					Get.-Nr. F13, Get.-Nr. F17	EAY,GS,TW	0 986 486 588	31
					Get.-Nr. M20	EAY	0 986 486 589	34
						GS	0 986 486 591	34
			12.09→	48	Get.-Nr. F13	MG5,TW	0 986 486 584	31
						Get.-Nr. F13, Get.-Nr. F17	EAY,MG5,TW	0 986 486 588
				Get.-Nr. M20	EAY	0 986 486 589	34	
				Get.-Nr. M20, Get.-Nr. M32	MG6	0 986 486 591	34	

		S							
1.2 LPG		07.06→	51/57/59/	Get.-Nr. F13	MG5,TW	0 986 486 584	31		
1.2 Twinport			63	Get.-Nr. F13, Get.-Nr. F17	EAY, MG5, TW	0 986 486 588	31		
				Get.-Nr. M20	EAY	0 986 486 589	34		
				Get.-Nr. M20, Get.-Nr. M32	MG6	0 986 486 591	34		
1.3 CDTI		07.06-06.10	55	Get.-Nr. F13	GS, TW	0 986 486 584	31		
				Get.-Nr. F13, Get.-Nr. F17	EAY, GS, TW	0 986 486 588	31		
				Get.-Nr. M20	EAY, TW	0 986 486 589	34		
					GS, TW	0 986 486 591	34		
		07.06-07.10	66	Get.-Nr. F13	GS	0 986 486 584	31		
				Get.-Nr. F13, Get.-Nr. F17	EAY, GS, TW	0 986 486 588	31		
				Get.-Nr. M20	EAY	0 986 486 589	34		
					GS	0 986 486 591	34		
		10.06-02.09	66		F13	0 986 486 588	31		
		12.09→	70	Get.-Nr. F13	GS, TW	0 986 486 584	31		
				Get.-Nr. F13, Get.-Nr. F17	EAY, GS, TW	0 986 486 588	31		
				Get.-Nr. M20	EAY, TW	0 986 486 589	34		
					GS, TW	0 986 486 591	34		
		01.11→	55	Get.-Nr. F13	GS, TW	0 986 486 584	31		
				Get.-Nr. F13, Get.-Nr. F17	EAY, GS, TW	0 986 486 588	31		
				Get.-Nr. M20	EAY, TW	0 986 486 589	34		
					GS, TW	0 986 486 591	34		
1.4 LPG		09.09-11.10	64	Get.-Nr. M20	MG6	0 986 486 591	34		
1.4 LPG		09.09→	64	Get.-Nr. F13	MG5, TW	0 986 486 584	31		
1.4 Twinport				Get.-Nr. F13, Get.-Nr. F17	EAY, MG5, TW	0 986 486 588	31		
				Get.-Nr. M20	EAY	0 986 486 589	34		
1.4 Twinport		07.06-11.10	66	Get.-Nr. F13	MG5, TW	0 986 486 584	31		
				Get.-Nr. F13, Get.-Nr. F17	EAY, MG5, TW	0 986 486 588	31		
				Get.-Nr. M20	EAY	0 986 486 589	34		
					MG6	0 986 486 591	34		
		12.09→	64	Get.-Nr. M20, Get.-Nr. M32	MG6	0 986 486 591	34		
1.4 Twinport		12.09→	74/88	Get.-Nr. F13	MG5, TW	0 986 486 584	31		
1.4 Twinport Turbo				Get.-Nr. F13, Get.-Nr. F17	EAY, MG5, TW	0 986 486 588	31		
				Get.-Nr. M20	EAY	0 986 486 589	34		
				Get.-Nr. M20, Get.-Nr. M32	MG6	0 986 486 591	34		
1.6 i OPC Turbo		02.07-10.09	141	Get.-Nr. F13	TW	0 986 486 584	31		
				Get.-Nr. F13, Get.-Nr. F17	TW	0 986 486 588	31		
				Get.-Nr. M20, Get.-Nr. M32	GS	0 986 486 591	34		
		02.07→	141	Get.-Nr. M20	EAY	0 986 486 589	34		
		11.09→	141	Get.-Nr. F13	MG5, TW	0 986 486 584	31		
				Get.-Nr. F13, Get.-Nr. F17	EAY, MG5, TW	0 986 486 588	31		
				Get.-Nr. M20, Get.-Nr. M32	MG6	0 986 486 591	34		
		10.11→	155	Get.-Nr. F13	MG5, TW	0 986 486 584	31		
				Get.-Nr. F13, Get.-Nr. F17	EAY, MG5, TW	0 986 486 588	31		
				Get.-Nr. M20	EAY	0 986 486 589	34		
				Get.-Nr. M20, Get.-Nr. M32	MG6	0 986 486 591	34		
1.6 i Turbo		02.07-10.09	110		EAY	0 986 486 589	34		
				Get.-Nr. F13	GS	0 986 486 584	31		
				Get.-Nr. F13, Get.-Nr. F17	EAY, GS, TW	0 986 486 588	31		
				Get.-Nr. M20, Get.-Nr. M32	GS	0 986 486 591	34		
		11.09→	110	Get.-Nr. F13	MG5, TW	0 986 486 584	31		
				Get.-Nr. F13, Get.-Nr. F17	EAY, MG5, TW	0 986 486 588	31		
				Get.-Nr. M20	EAY	0 986 486 589	34		
				Get.-Nr. M20, Get.-Nr. M32	MG6	0 986 486 591	34		
1.7 CDTI		07.06-02.09	92		F13	0 986 486 588	31		
				Get.-Nr. F13	GS	0 986 486 584	31		
				Get.-Nr. M20	EAY	0 986 486 589	34		
					GS	0 986 486 591	34		
		07.06-06.10	92	Get.-Nr. F13	GS, TW	0 986 486 584	31		
				Get.-Nr. F13, Get.-Nr. F17	EAY, GS, TW	0 986 486 588	31		
				Get.-Nr. M20	EAY, TW	0 986 486 589	34		
					GS, TW	0 986 486 591	34		
				Get.-Nr. M32	GS, TW	0 986 486 594	34		



◀ OPEL Corsa [D]									
1.7 CDTI	12.09→	96	Get.-Nr. F13	GS,TW	0 986 486 584	31			
			Get.-Nr. F13, Get.-Nr. F17	EAY,GS,TW	0 986 486 588	31			
			Get.-Nr. M20	EAY,TW	0 986 486 589	34			
				GS,TW	0 986 486 591	34			
			Get.-Nr. M32	GS,TW	0 986 486 594	34			
1.0 Twinport	07.06-10.09	44	Fg.-Nr. →74999999, →76999999		0 265 232 239 ^B				
			Fg.-Nr. →84999999, →86999999	MBH	0 265 230 288 ^T				
			Fg.-Nr. B4000001→, B6000001→	MBH	0 265 230 286 ^T				
			Fg.-Nr. B4000001→, B6000001→	MBH	0 265 251 871 ^T				
			Fg.-Nr. B4000001→, B6000001→	MBH	0 265 251 870 ^T				
	12.09→	48		SSJ	0 265 232 239 ^B				
			Fg.-Nr. B4000001→, B6000001→	SSJ	0 265 232 289 ^B				
			Fg.-Nr. B4000001→, B6000001→	MBH	0 265 251 871 ^T				
			Fg.-Nr. B4000001→, B6000001→	MBH	0 265 251 870 ^T				
			Fg.-Nr. B4000001→, B6000001→	SSJ	0 265 232 289 ^B				
1.2 LPG	09.09→	51/57		SSJ	0 265 232 289 ^B				
1.2 Twinport			Fg.-Nr. B4000001→, B6000001→	MBH	0 265 251 871 ^T				
			Fg.-Nr. B4000001→, B6000001→	MBH	0 265 251 870 ^T				
1.2 Twinport	07.06-12.11	59	Fg.-Nr. →74999999, →76999999		0 265 232 239 ^B				
			Fg.-Nr. →84999999, →86999999	MBH	0 265 230 288 ^T				
			Fg.-Nr. B4000001→, → B6000001	MBH	0 265 230 286 ^T				
			Fg.-Nr. B4000001→, → B6000001	MBH	0 265 251 871 ^T				
			Fg.-Nr. B4000001→, → B6000001	MBH	0 265 251 870 ^T				
	12.09→	63		SSJ	0 265 232 239 ^B				
			Fg.-Nr. B4000001→, B6000001→	SSJ	0 265 232 289 ^B				
			Fg.-Nr. B4000001→, B6000001→	MBH	0 265 251 871 ^T				
			Fg.-Nr. B4000001→, B6000001→	MBH	0 265 251 870 ^T				
			Fg.-Nr. B4000001→, B6000001→	SSJ	0 265 232 289 ^B				
1.3 CDTI	07.06-06.10	55	Fg.-Nr. →74999999, →76999999		0 265 232 239 ^B				
			Fg.-Nr. →84999999, →86999999	MBH	0 265 230 288 ^T				
			Fg.-Nr. B4000001→, B6000001→	MBH	0 265 230 286 ^T				
			Fg.-Nr. B4000001→, B6000001→	MBH	0 265 251 871 ^T				
			Fg.-Nr. B4000001→, B6000001→	MBH	0 265 251 870 ^T				
	07.06-07.10	66		SSJ	0 265 232 239 ^B				
			Fg.-Nr. →74999999, →76999999		0 265 232 239 ^B				
			Fg.-Nr. →84999999, →86999999	MBH	0 265 230 288 ^T				
			Fg.-Nr. →84999999, →86999999	MBH	0 265 230 286 ^T				
			Fg.-Nr. 84000001→84999999, 86000001→86999999		0 265 232 239 ^B				
	10.06-02.09	66		SSJ	0 265 232 289 ^B				
			Fg.-Nr. 94000001→, 96000001→	SSJ	0 265 232 289 ^B				
			Fg.-Nr. 94000001→, 96000001→	MBH	0 265 230 288 ^T				
			Fg.-Nr. 94000001→, 96000001→	MBH	0 265 230 286 ^T				
			Fg.-Nr. 94000001→, 96000001→	RDK	0 265 232 239 ^T				
12.09-09.10	70		RDK	0 265 231 844 ^T					
		Fg.-Nr. 94000001→, 96000001→	SSJ	0 265 232 289 ^B					
		Fg.-Nr. 94000001→, 96000001→	SSJ	0 265 232 289 ^B					
		Fg.-Nr. 94000001→, 96000001→	SSJ	0 265 232 289 ^B					
		Fg.-Nr. 94000001→, 96000001→	SSJ	0 265 232 289 ^B					
10.10→	70	Fg.-Nr. B4000001→, B6000001→	MBH	0 265 251 871 ^T					
		Fg.-Nr. B4000001→, B6000001→	MBH	0 265 251 870 ^T					
		Fg.-Nr. B4000001→, B6000001→	MBH	0 265 251 871 ^T					
01.11→	55		MBH	0 265 251 871 ^T					
			MBH	0 265 251 870 ^T					
			SSJ	0 265 232 289 ^B					
1.4 LPG	09.09-11.10	64		SSJ	0 265 232 289 ^B				

		S										
1.4 Twinport	07.06-11.10	66	Fg.-Nr. →74999999, →76999999					0 265 232 239 ^B				
			Fg.-Nr. →84999999, →86999999	MBH			0 265 230 288 ^T					
				MBH			0 265 230 286 ^T					
			Fg.-Nr. 84000001→84999999, 86000001→86999999				0 265 232 239 ^B					
			Fg.-Nr. 94000001→, 96000001→	SSJ			0 265 232 289 ^B					
			12.09→	64			SSJ		0 265 232 289 ^B			
					Fg.-Nr. B4000001→, B6000001→	MBH			0 265 251 871 ^T			
						MBH			0 265 251 870 ^T			
				74			SSJ		0 265 232 289 ^B			
					Fg.-Nr. B4000001→, B6000001→	MBH			0 265 251 871 ^T			
			MBH			0 265 251 870 ^T						
1.4 Twinport Turbo	07.12→	88					MBH	0 265 251 871 ^T				
							MBH	0 265 251 870 ^T				
							SSJ	0 265 232 289 ^B				
1.6 i OPC Turbo	02.07-10.09	141	Fg.-Nr. →74999999, →76999999					0 265 232 239 ^B				
			Fg.-Nr. →84999999, →86999999	MBH			0 265 230 288 ^T					
				MBH			0 265 230 286 ^T					
			Fg.-Nr. 84000001→84999999, 86000001→86999999				0 265 232 239 ^B					
			Fg.-Nr. 94000001→, 96000001→	SSJ			0 265 232 289 ^B					
			11.09→	141			SSJ		0 265 232 289 ^B			
					Fg.-Nr. B4000001→, B6000001→	MBH			0 265 251 871 ^T			
						MBH			0 265 251 870 ^T			
				10.11→	155				MBH	0 265 251 871 ^T		
									MBH	0 265 251 870 ^T		
						SSJ	0 265 232 289 ^B					
1.6 i Turbo	02.07-10.09	110	Fg.-Nr. →84999999, →86999999	MBH				0 265 230 288 ^T				
				MBH			0 265 230 286 ^T					
			Fg.-Nr. 94000001→, 96000001→	SSJ			0 265 232 289 ^B					
			11.09→	110			SSJ		0 265 232 289 ^B			
					Fg.-Nr. B4000001→, B6000001→	MBH			0 265 251 871 ^T			
			MBH			0 265 251 870 ^T						
1.7 CDTI	07.06-02.09	92					MBH	0 265 230 288 ^T				
							MBH	0 265 230 286 ^T				
							RDK		0 265 232 239 ^T			
							RDK		0 265 231 844 ^T			
	07.06-06.10	92	Fg.-Nr. →74999999, →76999999				TW		0 265 232 239 ^B			
			Fg.-Nr. →84999999, →86999999	MBH				0 265 230 288 ^T				
				MBH				0 265 230 286 ^T				
			Fg.-Nr. B4000001→, B6000001→	MBH				0 265 251 871 ^T				
				MBH				0 265 251 870 ^T				
		Fg.-Nr. 84000001→84999999, 86000001→86999999					0 265 232 239 ^B					
		Fg.-Nr. 94000001→, 96000001→	SSJ				0 265 232 289 ^B					
12.09→	96					SSJ	0 265 232 289 ^B					
		Fg.-Nr. B4000001→, B6000001→	MBH				0 265 251 871 ^T					
			MBH				0 265 251 870 ^T					
	1.2 Twinport	12.09→	51/63					MBH	0 265 005 657			
								MBH	0 265 005 816			
1.3 CDTI	10.06-02.09	66						MBH	0 265 005 657			
							MBH	0 265 005 816				
1.7 CDTI	07.06-02.09	92						MBH	0 265 005 657			
							MBH	0 265 005 816				





◀ OPEL

Corsa [E]



	1.0	10.14→	66/85	LLE,STB	0 204 803 866	22,2
				RLE,STB	0 204 123 743	22,2
				4SB,LLE	0 204 822 479	
				4SB,RLE	0 204 123 744	23,81
	1.2	10.14→	51	LLE,STB	0 204 803 866	22,2
				RLE,STB	0 204 123 743	22,2
				4SB,LLE	0 204 822 479	
				4SB,RLE	0 204 123 744	23,81
	1.3	10.14→	55/70	LLE,STB	0 204 803 866	22,2
				RLE,STB	0 204 123 743	22,2
				4SB,LLE	0 204 822 479	
				4SB,RLE	0 204 123 744	23,81
	1.4	10.14→	55/66/74/ 110	LLE,STB	0 204 803 866	22,2
				RLE,STB	0 204 123 743	22,2
				4SB,LLE	0 204 822 479	
				4SB,RLE	0 204 123 744	23,81
	1.6	03.15→	148-152	LLE,STB	0 204 803 866	22,2
				RLE,STB	0 204 123 743	22,2
				4SB,LLE	0 204 822 479	
				4SB,RLE	0 204 123 744	23,81

	1.0	10.14→	66/85	LLE,STB	0 204 125 870	
				4SB,LLE,VSP	0 204 125 869	
				4SB,LLE,SBJ	0 204 831 726	
				4SB,RLE,SBJ	0 204 831 728	
	1.2	10.14→	51	LLE,STB	0 204 125 870	
				4SB,LLE,VSP	0 204 125 869	
				4SB,LLE,SBJ	0 204 831 726	
				4SB,RLE,SBJ	0 204 831 728	
	1.3	10.14→	55/70	LLE,STB	0 204 125 870	
				4SB,LLE,VSP	0 204 125 869	
				4SB,LLE,SBJ	0 204 831 726	
				4SB,RLE,SBJ	0 204 831 728	
	1.4	10.14→	55/66/74/ 110	LLE,STB	0 204 125 870	
				4SB,LLE,VSP	0 204 125 869	
				4SB,LLE,SBJ	0 204 831 726	
				4SB,RLE,SBJ	0 204 831 728	
	1.6	03.15→	148-152	LLE,STB	0 204 125 870	
				4SB,LLE,VSP	0 204 125 869	
				4SB,LLE,SBJ	0 204 831 726	
				4SB,RLE,SBJ	0 204 831 728	

	1.6	03.15→	148-152	Get.-Nr. M32	MG6	0 986 486 591	34
--	------------	--------	---------	--------------	-----	----------------------	----

Frontera [A]



	2.0 i	02.95-08.98	85	Fg.-Nr. TV815830→	LLE	0 204 123 508	
				Fg.-Nr. TV818522→	RLE	0 204 123 508	
	2.2 i	02.95-08.98	100	Fg.-Nr. TV815830→	LLE	0 204 123 508	
				Fg.-Nr. TV818522→	RLE	0 204 123 508	
	2.5 TDS Turbo	06.96-08.98	85	Fg.-Nr. TV814227→	LLE	0 204 123 508	
				Fg.-Nr. TV822888→	RLE	0 204 123 508	
	2.8 TDI	02.95-08.98	83	Fg.-Nr. TV814227→	LLE	0 204 123 508	
				Fg.-Nr. TV822888→	RLE	0 204 123 508	



Insignia Sports Tourer [35]

	1.6	02.09→	85/132	Fg.-Nr. →91999999			0 265 005 543	
	1.8	02.09→	103	Fg.-Nr. →91999999			0 265 005 543	
	2.0 CDTI, CDTI 4x4, Turbo, Turbo 4x4	02.09→	81/96/118/ 140-143/ 162/184		TW		0 265 005 543	
	2.8 Turbo 4x4	02.09→	191/239	Fg.-Nr. →91999999			0 265 005 543	

Insignia [68]

	1.6	09.08→	85/132	Fg.-Nr. →91999999			0 265 005 543	
	1.8	09.08→	103	Fg.-Nr. →91999999			0 265 005 543	
	2.0 CDTI, CDTI 4x4, Turbo, Turbo 4x4	09.08→	81/96/118/ 140-143/ 162/184		TW		0 265 005 543	
	2.8 Turbo 4x4	09.08→	191/239	Fg.-Nr. →91999999			0 265 005 543	

Insignia [69]

	1.6	09.08→	85/132	Fg.-Nr. →91999999			0 265 005 543	
	1.8	09.08→	103	Fg.-Nr. →91999999			0 265 005 543	
	2.0 CDTI, CDTI 4x4, Turbo, Turbo 4x4	09.08→	81/96/118/ 140-143/ 162/184		TW		0 265 005 543	
	2.8 Turbo 4x4	09.08→	191/239	Fg.-Nr. →91999999			0 265 005 543	

Meriva [A]

	1.3 CDTI	MFD 09.03-03.10	51/55	Fg.-Nr. →44999999	JBH		0 986 480 884	23,8
				Fg.-Nr. 54000001→64999999			0 204 123 663	23,8
		OFD 09.03-03.10	51/55	Fg.-Nr. →44999999	JBH		0 986 480 885	23,8
				Fg.-Nr. 54000001→64999999			0 204 123 664	23,8
	1.4 i Twinport	MFD 07.04-03.10	66	Fg.-Nr. →44999999	JBH		0 986 480 884	23,8
				Fg.-Nr. 54000001→64999999			0 204 123 663	23,8
		OFD 07.04-03.10	66	Fg.-Nr. →44999999	JBH		0 986 480 885	23,8
				Fg.-Nr. 54000001→64999999			0 204 123 664	23,8
	1.6 i	MFD 03.03-03.10	64/74/77/	Fg.-Nr. →44999999	JBH		0 986 480 884	23,8
	1.6 i OPC Turbo		132	Fg.-Nr. 54000001→64999999			0 204 123 663	23,8
	1.6 i 16V Twinport	OFD 03.03-03.10	64/74/77/	Fg.-Nr. →44999999	JBH		0 986 480 885	23,8
			132	Fg.-Nr. 54000001→64999999			0 204 123 664	23,8
	1.7 CDTI	MFD 03.03-03.10	55/74/92	Fg.-Nr. →44999999	JBH		0 986 480 884	23,8
	1.7 DTI			Fg.-Nr. 54000001→64999999			0 204 123 663	23,8
		OFD 03.03-03.10	55/74/92	Fg.-Nr. →44999999	JBH		0 986 480 885	23,8
				Fg.-Nr. 54000001→64999999			0 204 123 664	23,8
	1.8 i 16V	MFD 03.03-03.10	92	Fg.-Nr. →44999999	JBH		0 986 480 884	23,8
				Fg.-Nr. 54000001→64999999			0 204 123 663	23,8
		OFD 03.03-03.10	92	Fg.-Nr. →44999999	JBH		0 986 480 885	23,8
				Fg.-Nr. 54000001→64999999			0 204 123 664	23,8
	1.3 CDTI	09.03-03.10	51/55	Fg.-Nr. 54000001→64999999			0 204 125 827	
	1.4 i Twinport	07.04-03.10	66	Fg.-Nr. 54000001→64999999			0 204 125 827	
	1.6 i, i OPC Turbo, i 16V Twinport	03.03-03.10	64/74/77/ 132	Fg.-Nr. 54000001→64999999			0 204 125 827	
	1.7 CDTI, DTI	03.03-03.10	55/74/92	Fg.-Nr. 54000001→64999999			0 204 125 827	
	1.8 i 16V	03.03-03.10	92	Fg.-Nr. 54000001→64999999			0 204 125 827	



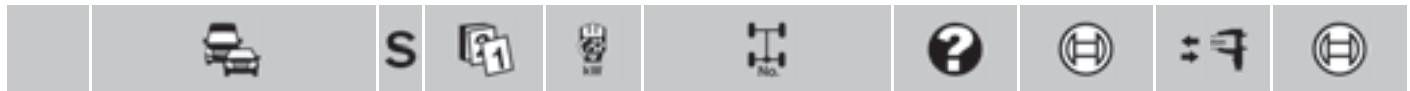

◀ OPEL Meriva [A]

	1.3 CDTI	09.03-03.10	51/55		0 986 486 588	31					
	1.4 i Twinport	07.04-03.10	66		0 986 486 588	31					
	1.6 i, i OPC Turbo, i 16V Twinport	03.03-03.10	64/74/77/132		0 986 486 588	31					
	1.7 CDTI, DTI	03.03-09.09	55/74		0 986 486 588	31					
	1.8 i 16V	03.03-03.10	92		0 986 486 588	31					
	1.3 CDTI	09.03-03.10	51/55	Fg.-Nr. →44999999	0 265 202 503 ^T						
					0 265 216 479 ^B						
						0 265 220 659 ^F					
						0 265 232 213 ^B					
						0 265 234 340 ^T					
	1.4 i Twinport	07.04-03.10	66	Fg.-Nr. 54000001→	0 265 232 213 ^B						
					0 265 234 340 ^T						
	1.6 i	03.03-03.10	64/74/77/132	Fg.-Nr. →44999999	0 265 202 503 ^T						
					0 265 216 479 ^B						
					0 265 220 659 ^F						
						0 265 232 213 ^B					
						0 265 234 340 ^T					
	1.6 i OPC Turbo	03.03-03.10	64/74/77/132	Fg.-Nr. →44999999	0 265 202 503 ^T						
					0 265 216 479 ^B						
					0 265 220 659 ^F						
						0 265 232 213 ^B					
						0 265 234 340 ^T					
	1.6 i 16V Twinport	03.03-03.10	92	Fg.-Nr. →44999999	0 265 202 503 ^T						
					0 265 216 479 ^B						
					0 265 220 659 ^F						
					0 265 232 213 ^B						
					0 265 234 340 ^T						
1.7 CDTI	09.03-09.09	74	Fg.-Nr. →44999999	0 265 202 503 ^T							
				0 265 216 479 ^B							
				0 265 220 659 ^F							
					0 265 232 213 ^B						
					0 265 234 340 ^T						
1.7 DTI	03.03-09.05	55	Fg.-Nr. →44999999	0 265 216 479 ^B							
				0 265 202 503 ^T							
				0 265 220 659 ^F							
					0 265 234 340 ^T						
					0 265 232 213 ^B						
1.7 DTI	03.03-09.05	55	Fg.-Nr. →44999999	0 265 216 479 ^B							
				0 265 202 503 ^T							
				0 265 220 659 ^F							
					0 265 234 340 ^T						
					0 265 232 213 ^B						
1.8 i 16V	03.03-03.10	92	Fg.-Nr. →44999999	0 265 202 503 ^T							
				0 265 216 479 ^B							
				0 265 220 659 ^F							
					0 265 232 213 ^B						
					0 265 234 340 ^T						
	1.3 CDTI	09.03-03.10	51/55	Fg.-Nr. →44999999	0 265 005 262						
										0 265 005 270	
										0 265 005 657	
						0 265 005 816					
	1.4 i Twinport	07.04-03.10	66	Fg.-Nr. →44999999	0 265 005 262						
										0 265 005 270	
										0 265 005 657	
						0 265 005 816					
	1.6 i	03.03-03.10	64/74/77/132	Fg.-Nr. →44999999	0 265 005 262						
										0 265 005 270	
										0 265 005 657	
						0 265 005 816					
	1.6 i OPC Turbo	03.03-03.10	64/74/77/132	Fg.-Nr. 54000001→54999999	0 265 005 262						
										0 265 005 270	
										0 265 005 657	
						0 265 005 816					
	1.6 i 16V Twinport	03.03-03.10	92	Fg.-Nr. 64000001→	0 265 005 657						
										0 265 005 816	
										0 265 005 262	
						0 265 005 270					
1.7 CDTI	03.03-03.10	55/74/92	Fg.-Nr. →44999999	0 265 005 262							
									0 265 005 270		
									0 265 005 657		
					0 265 005 816						
1.7 DTI	03.03-03.10	55/74/92	Fg.-Nr. 54000001→54999999	0 265 005 262							
									0 265 005 270		
									0 265 005 657		
					0 265 005 816						
1.8 i 16V	03.03-03.10	92	Fg.-Nr. →44999999	0 265 005 262							
									0 265 005 270		
									0 265 005 657		
					0 265 005 816						
	1.3 CDTI	09.03-03.10	51/55		0 265 005 303						
	1.4 i Twinport	07.04-03.10	66		0 265 005 303						
	1.6 i, i OPC Turbo, i 16V Twinport	03.03-03.10	64/74/77/132		0 265 005 303						
	1.7 CDTI, DTI	03.03-03.10	55/74/92		0 265 005 303						
	1.8 i 16V	03.03-03.10	92		0 265 005 303						



Meriva [B]

	1.4 ecoFLEX	04.10→	88	Get.-Nr. F13, Get.-Nr. F17 Get.-Nr. M32	TW TW	0 986 486 588 0 986 486 591	31 34
		10.12→	88			0 986 486 591	34
	1.4 Ecotec	04.10→	74			0 986 486 588	31
	1.4 Ecotec, Turbo	04.10→	103			0 986 486 591	34
	1.6 CDTI	10.13→	70/81/100			0 986 486 590	34
	1.7 CDTI	06.10→	74/81/96			0 986 486 590	34

Mokka

	1.4 Turbo ecoFLEX	03.15→	103	Fg.-Nr. →EB999999, Get.-Nr. M32	MG6,TW	0 986 486 590 0 986 486 591	34 34
	1.4 Turbo ecoFLEX	01.13→	103	Get.-Nr. M32	MG6,TW	0 986 486 590 0 986 486 591	34 34
	1.4 Turbo ecoFLEX 4x4	09.12→	103	Get.-Nr. M32	MG6,TW	0 986 486 590 0 986 486 591	34 34
		03.15→	103	Fg.-Nr. →EB999999, Get.-Nr. M32	MG6,TW	0 986 486 590 0 986 486 591	34 34
	1.6 ecoFLEX	09.12→	85	Get.-Nr. M32	MG6,TW	0 986 486 590 0 986 486 591	34 34
		03.15→	85	Fg.-Nr. →EB999999, Get.-Nr. M32	MG6,TW	0 986 486 590 0 986 486 591	34 34
	1.7 CDTI ecoFLEX	09.12→	96	Get.-Nr. M32	MG6,TW	0 986 486 590 0 986 486 591	34 34
	1.8	09.12→	103	Get.-Nr. M32	MG6,TW	0 986 486 590	34
	1.8 4x4					0 986 486 591	34

Monterey [A]

	3.1 TD	10.95-12.97	84			0 204 123 508	
	3.2 i	10.95-12.97	130			0 204 123 508	

Monterey [B]

	3.0 DTI	02.98-12.99	117			0 204 123 508	
	3.5 iV6	02.98-12.99	158			0 204 123 508	

Movano [A]

	1.9 D	ABO 01.99-10.05	59/60	Fg.-Nr. →3V999999, →3Y999999		0 204 123 651	23,8
	1.9 DTI	ABS 01.99-10.05	59/60	Fg.-Nr. →3V999999, →3Y999999		0 204 123 409	
	2.2 DTI	ABO 09.00-10.05	66	Fg.-Nr. →3V999999, →3Y999999		0 204 123 651	23,8
		ABS 09.00-10.05	66	Fg.-Nr. →3V999999, →3Y999999		0 204 123 409	
	2.5 D	ABO 10.98-03.10	59/73-74/ 84	Fg.-Nr. →3V999999, →3Y999999		0 204 123 651	23,8
	2.5 DTI	ABS 10.98-03.10	59/73-74	Fg.-Nr. →3V999999, →3Y999999		0 204 123 409	
	2.5 DTI	ABS 10.01-10.07	84	Fg.-Nr. →3V999999, →3Y999999		0 204 123 409	
		08.06-03.10	88/107	Fg.-Nr. →B519999, →B669999, →B519999, →B630000, →B540000		0 204 123 409	
				Fg.-Nr. B537017→, B847869→, B527378→, B794001→, B560939→		0 204 123 763	23,81
		09.06-06.10	74	Fg.-Nr. →B519999, →B669999, →B519999, →B630000, →B540000		0 204 123 409	
				Fg.-Nr. B537017→, B847869→, B527378→, B794001→, B560939→		0 204 123 763	23,81



		S								
◀ OPEL Movano [A]										
	2.8 DTI	ABO	06.98-09.02	84	Fg.-Nr. →3V999999, →3Y999999		0 204 123 651	23,8		
		ABS	06.98-09.02	84	Fg.-Nr. →3V999999, →3Y999999		0 204 123 409			
	3.0 CDTI	ABO	03.03-10.05	100	Fg.-Nr. →3V999999, →3Y999999		0 204 123 651	23,8		
		ABS	03.03-10.05	100	Fg.-Nr. →3V999999, →3Y999999		0 204 123 409			
	1.9 D, DTI		01.99-10.05	59/60			0 986 486 596	27		
	2.2 DTI		09.00-10.05	66			0 986 486 596	27		
	2.5 DTI		10.01-10.07	84			0 986 486 596	27		
			10.01-03.10	73-74			0 986 486 596	27		
			08.06-03.10	88/107	TW		0 986 486 596	27		
			09.06-06.10	74	Y32		0 986 486 596	27		
	2.8 DTI		06.98-09.02	84			0 986 486 596	27		
3.0 CDTI		03.03-10.05	100			0 986 486 596	27			
Omega [A]										
	1.8		09.86-03.94	60/65/66/85	JBH,LKO ATE		0 986 480 751	19		
	1.8 i				LLE ATE		0 986 480 750	19		
	1.8 S	ABO	09.86-03.94	60/65/66/85	JBH,RLE		0 986 480 644	22,2		
		ABS	09.86-03.94	60/65/66/85	JBH,LLE		0 986 480 892	19		
	2.0 i		09.86-03.94	85/90	JBH,RLE		0 986 480 643	20,6		
		ABS	09.86-03.94	85/90	JBH,LLE		0 986 480 751	19		
	2.3 D		09.86-03.94	54/74	JBH,LKO ATE		0 986 480 751	19		
		2.3 TD			LLE ATE		0 986 480 750	19		
	2.4 i	ABO	09.88-03.94	92	JBH,LLE		0 986 480 751	19		
		ABS	09.88-03.94	92	JBH,RLE		0 986 480 644	22,2		
	2.6 i		09.90-03.94	110	LLE ATE		0 986 480 756	20,6		
		3.0 i	ABS	01.88-03.94	130/147-150	LLE ATE		0 986 480 756	20,6	
	1.8, i, S		09.86-03.94	60/65/66/85	V02 ATE		0 986 485 100			
	2.0 i		09.86-03.94	85/90	V02 ATE		0 986 485 100			
	2.3 D, TD		09.86-03.94	54/74	V02 ATE		0 986 485 100			
	2.4 i		09.88-03.94	92	V02 ATE		0 986 485 100			
	2.6 i		09.90-03.94	110	KOB,V02 ATE		0 986 485 100			
	3.0 i, i Evol. 500		01.88-03.94	130/147-150/169	KOB,V02 ATE		0 986 485 100			
	3.6 i		01.90-03.94	277-281	KOB,V02 ATE		0 986 485 100			
	1.8, i, S		09.86-03.94	60/65/66/85			0 265 200 041 ^H			
	2.0 i		09.86-03.94	85/90			0 265 200 041 ^H			
	2.3 D, TD		09.86-03.94	54/74			0 265 200 041 ^H			
	2.4 i		09.88-03.94	92			0 265 200 041 ^H			
	1.8, i, S		09.86-03.94	60/65/66/85	Fg.-Nr. →K1000098		0 265 103 016 ^H			
	2.0 i				Fg.-Nr. K1000099→		0 265 103 034 ^H			
						Fg.-Nr. →K1000098		0 265 103 016 ^H		
	2.3 D		09.86-03.94	54/74	Fg.-Nr. →K1000098		0 265 103 016 ^H			
	2.3 TD				Fg.-Nr. K1000099→		0 265 103 034 ^H			
	2.4 i					Fg.-Nr. →K1000098		0 265 103 016 ^H		
						Fg.-Nr. K1000099→		0 265 103 034 ^H		
2.6 i		09.90-03.94	110	Fg.-Nr. →K1000098		0 265 103 016 ^H				
3.0 i					Fg.-Nr. K1000099→		0 265 103 034 ^H			
			01.88-03.94	130/147-150	Fg.-Nr. →K1000098		0 265 103 016 ^H			
					Fg.-Nr. K1000099→		0 265 103 034 ^H			



Omega [B]



	2.0 DTI Turbo, i	OFD	09.93-08.00	74/85/100	Fg.-Nr. W1000001→	LLE	0 986 480 846	25,4
	2.0 i		09.93-08.99	85/100	Fg.-Nr. →V1999999	ERH,LLE	0 986 480 134	25,4
						LLE	0 986 480 133	23,8
	2.2 DTI		06.00-07.03	88		LLE	0 986 480 846	25,4
	2.2 i	OFD	09.99-09.03	103-106			0 986 480 846	25,4
	2.5 DTI Turbo	OFD	06.01-09.03	110			0 986 480 846	25,4
	2.5 i	OFD	04.94-11.00	125	Fg.-Nr. W1000001→	LLE	0 986 480 846	25,4
	2.5 i, TD		04.94-02.01	96/125	Fg.-Nr. →V1999999	LLE	0 986 480 134	25,4
	2.5 TD	OFD	04.94-02.01	96	Fg.-Nr. W1000001→	LLE	0 986 480 846	25,4
	2.6 i	OFD	09.00-09.03	132			0 986 480 846	25,4
	3.0 i		04.94-02.01	155	Fg.-Nr. →V1999999	LLE	0 986 480 134	25,4
		OFD	04.94-02.01	155	Fg.-Nr. W1000001→	LLE	0 986 480 846	25,4
	3.2 i	OFD	09.00-09.03	160			0 986 480 846	25,4

	2.0 DTI Turbo, i		09.93-08.00	74/85/100			0 986 486 036	19,05
	2.2 DTI, i		09.99-09.03	88/103-106			0 986 486 036	19,05
	2.5 DTI Turbo		06.01-09.03	110			0 986 486 036	19,05
	2.5 i		04.94-11.00	125			0 986 486 036	19,05
	2.5 TD		04.94-02.01	96			0 986 486 036	19,05
	2.6 i		09.00-09.03	132			0 986 486 036	19,05
	3.0 i		04.94-02.01	155			0 986 486 036	19,05
	3.2 i		09.00-09.03	160			0 986 486 036	19,05

	2.0 DTI Turbo		09.97-08.00	74			0 265 216 473 ^B		
	2.0 i		09.93-08.99	100	Fg.-Nr. W1000001→		0 265 216 473 ^B		
						Fg.-Nr. Y1000001→	TW	0 265 216 475 ^H	
			04.94-08.98	85	Fg.-Nr. W1000001→		0 265 216 473 ^B		
	2.2 DTI, i		09.99-09.03	88/103-106	Fg.-Nr. Y1000001→		0 265 216 475 ^H		
	2.5 DTI Turbo		06.01-09.03	110				0 265 220 645 ^J	
			MFD	06.01-09.03	110			0 265 202 513 ^J	
	2.5 i		04.94-11.00	125	Fg.-Nr. W1000001→		0 265 220 449 ^F		
	2.5 TD		04.94-02.01	96	Fg.-Nr. W1000001→			0 265 216 473 ^B	
				04.96-11.00	96	Fg.-Nr. Y1000001→	TW	0 265 216 475 ^H	
	2.6 i		09.00-09.03	132				0 265 220 645 ^J	
			MFD	09.00-09.03	132			0 265 202 513 ^J	
	3.0 i		04.94-02.01	155	Fg.-Nr. W1000001→		0 265 220 449 ^F		
	3.2 i		09.00-09.03	160				0 265 220 645 ^J	
			MFD	09.00-09.03	160			0 265 202 513 ^J	

	2.5 DTI Turbo	OFD	06.01-09.03	110		TEI	1 273 004 599 ^J	
	2.6 i	OFD	09.00-09.03	132		TEI	1 273 004 599 ^J	
	3.2 i	OFD	09.00-09.03	160		TEI	1 273 004 599 ^J	

Signum



	1.8 i	MFD	05.03-02.05	90		JBH,LLE	0 986 480 993	25,4	
						JBH,RLE	0 986 480 837		
			09.05-09.08	103		JBH,LLE	0 986 480 993	25,4	
						JBH,RLE	0 986 480 837		
			OFD	05.03-02.05	90		JBH,LLE	0 986 480 858	25,4
				09.05-09.08	103		JBH,LLE	0 986 480 858	25,4
	1.9 CDTI	MFD	04.04-09.08	74/88/110		JBH,LLE	0 986 480 993	25,4	
						JBH,RLE	0 986 480 837		
			OFD	04.04-09.08	88/110		JBH,LLE	0 986 480 858	25,4
	2.0 DTI	MFD	05.03-09.08	74/129		JBH,LLE	0 986 480 993	25,4	
						JBH,RLE	0 986 480 837		
	2.0 Turbo		OFD	05.03-09.08	74/129		JBH,LLE	0 986 480 858	25,4

		S							
◀ OPEL Signum									
		2.2 Direct	MFD	05.03-09.08	86-92/114		JBH,LLE	0986 480 993	25,4
		2.2 DTI					JBH,RLE	0986 480 837	
			OFD	05.03-09.08	86-92/114		JBH,LLE	0986 480 858	25,4
		3.0 CDTI	MFD	05.03-09.08	130-135		JBH,LLE	0986 480 993	25,4
							JBH,RLE	0986 480 837	
			OFD	05.03-09.08	130-135		JBH,LLE	0986 480 858	25,4
		3.2 V6	MFD	05.03-09.05	155		JBH,LLE	0986 480 993	25,4
							JBH,RLE	0986 480 837	
			OFD	05.03-09.05	155		JBH,LLE	0986 480 858	25,4
		1.8 i		05.03-02.05	90		LLE	0986 486 110	15,87
				09.05-09.08	103		LLE	0986 486 110	15,87
		1.9 CDTI		04.04-09.08	74/88/110		LLE	0986 486 110	15,87
		2.0 DTI, Turbo		05.03-09.08	74/129		LLE	0986 486 110	15,87
		2.2 Direct, DTI		05.03-09.08	86-92/114		LLE	0986 486 110	15,87
		2.8 V6 Turbo		09.05-09.08	169/184		LLE	0986 486 110	15,87
		3.0 CDTI		05.03-09.08	130-135		LLE	0986 486 110	15,87
		3.2 V6		05.03-09.05	155		LLE	0986 486 110	15,87
		1.8 i		05.03-02.05	90		KGH,MG5	0986 486 588	31
							LGH,MG5	0986 486 579	34
				09.05-09.08	103		KGH,MG5	0986 486 588	31
							LGH,MG5	0986 486 579	34
		2.0 DTI		05.03-09.05	74			0986 486 579	34
		2.0 Turbo		05.03-09.08	129		LGH,MG5	0986 486 579	34
		2.2 Direct, DTI		05.03-09.08	86-92/114			0986 486 579	34
		2.8 V6 Turbo		09.05-09.08	169/184			0986 486 579	34
		3.0 CDTI		05.03-09.05	130-135		LGH,MG5	0986 486 579	34
		3.2 V6		05.03-09.05	155			0986 486 579	34
Sintra									
		2.2 i 16V, TD		09.96-09.99	85/104		JBH,RLE	0986 480 942	23,8
		3.0 i 24V		09.96-09.99	148		JBH,RLE	0986 480 942	23,8
		2.2 i 16V, TD		09.96-09.99	85/104			0986 486 585	34
		3.0 i 24V		09.96-09.99	148			0986 486 585	34
Tigra [A]									
		1.4 i	ABO	09.94-08.99	63-66		JBH,LLE	0986 480 130	20,6
			ABS	09.94-08.99	63-66		JBH,LLE	0986 480 818	22
		1.6 i	ABO	09.94-08.99	74/78		JBH,LLE	0986 480 130	20,6
		1.6 i 16V	ABS	09.94-08.99	74/78		JBH,LLE	0986 480 818	22
		1.4 i		09.94-08.99	63-66	Fg.-Nr. T3000001→, T4000001→, T6000001→		0 265 216 410 ^B	
		1.6 i, i 16V		09.94-08.99	74/78	Fg.-Nr. T3000001→, T4000001→, T6000001→		0 265 216 410 ^B	
Tigra TwinTop [B]									
		1.3 CDTI	MFD	06.04-03.09	51			0 204 123 637	23,8
			OFD	06.04-03.09	51			F 026 003 638	23,81
		1.4 i	MFD	06.04-12.09	66			0 204 123 637	23,8
			OFD	06.04-12.09	66			F 026 003 638	23,81
		1.8 i	MFD	06.04-12.09	92			0 204 123 637	23,8
			OFD	06.04-12.09	92			F 026 003 638	23,81

		S								
	1.3 CDTI	06.04-03.09	51						0 204 125 812	
	1.4 i	06.04-12.09	66						0 204 125 812	
	1.8 i	06.04-12.09	92						0 204 125 812	
	1.3 CDTI	06.04-03.09	51						0 986 486 588	31
	1.4 i	06.04-12.09	66				EAY		0 986 486 588	31
							EAY		0 986 486 584	31
	1.8 i	06.04-12.09	92						0 986 486 588	31
	1.3 CDTI	06.04-03.09	51						0 265 232 215 ^B	
						Fg.-Nr. →5E999999			0 265 234 340 ^T	
						Fg.-Nr. 6E000001→			0 265 234 340 ^T	
	1.4 i	06.04-12.09	66						0 265 232 213 ^B	
							EAY		0 265 231 444 ^B	
							GS		0 265 231 307 ^B	
						Fg.-Nr. →5E999999			0 265 234 340 ^T	
						Fg.-Nr. 6E000001→			0 265 234 340 ^T	
1.8 i	06.04-12.09	92						0 265 232 215 ^B		
						Fg.-Nr. →5E999999			0 265 234 340 ^T	
						Fg.-Nr. 6E000001→			0 265 234 340 ^T	
	1.3 CDTI	06.04-03.09	51						0 265 005 270	
	1.4 i	06.04-12.09	66						0 265 005 270	
	1.8 i	06.04-12.09	92						0 265 005 270	
	1.3 CDTI	06.04-03.09	51						0 265 005 303	
	1.4 i	06.04-12.09	66						0 265 005 303	
	1.8 i	06.04-12.09	92						0 265 005 303	
Vectra [A]										
	1.6 i	ABO 09.92-08.95	55			Fg.-Nr. P1000001→ R7999999	DEL,JBH		0 986 480 130	20,6
						Fg.-Nr. S1000001→	DEL,JBH		0 986 480 132	22,2
			09.93-08.95	52			Fg.-Nr. →N5999999	DEL,JBH	0 986 480 114	20,64
						Fg.-Nr. P1000001→	DEL,JBH		0 986 480 130	20,6
	1.6 i KAT	ABO 09.88-08.95	55-60			Fg.-Nr. →N5999999	DEL,JBH		0 986 480 114	20,64
	1.6 S					Fg.-Nr. P1000001→	DEL,JBH		0 986 480 130	20,6
	1.6 i, i KAT, S	ABS 09.88-08.95	52/55-60				DEL,JBH		0 986 480 129	22,2
	1.6						JBH ATE		0 986 480 907	22
	1.7 D	ABO 10.88-08.95	42/60			Fg.-Nr. →N5999999	DEL,JBH		0 986 480 114	20,64
	1.7 TD					Fg.-Nr. P1000001→ R7999999	DEL,JBH		0 986 480 130	20,6
						Fg.-Nr. S1000001→	DEL,JBH		0 986 480 132	22,2
		ABS 10.88-08.95	42/60				DEL,JBH		0 986 480 129	22,2
							JBH ATE		0 986 480 907	22
	1.8	ABO 09.89-08.95	66			Fg.-Nr. →N5999999	DEL,JBH		0 986 480 114	20,64
	1.8 i					Fg.-Nr. S1000001→	DEL,JBH		0 986 480 132	22,2
	1.8, i, S, S 4x4, 4x4	ABS 09.88-08.95	65/66				DEL,JBH		0 986 480 129	22,2
							JBH ATE		0 986 480 907	22
	1.8, i, 4x4	ABO 09.89-08.95	66			Fg.-Nr. P1000001→ R7999999	DEL,JBH		0 986 480 130	20,6
	1.8 S	ABO 09.88-08.95	65			Fg.-Nr. →N5999999	DEL,JBH		0 986 480 114	20,64
						Fg.-Nr. P1000001→ R7999999	DEL,JBH		0 986 480 130	20,6
						Fg.-Nr. S1000001→	DEL,JBH		0 986 480 132	22,2
1.8 S 4x4	ABO 01.89-08.95	65				JBH ATE		0 986 480 752	22,2	
					Fg.-Nr. P1000001→ R7999999	DEL,JBH		0 986 480 130	20,6	
2.0 i	ABO 09.88-08.95	74-85				JBH ATE		0 986 480 752	22,2	
					Fg.-Nr. →N5999999	DEL		0 986 480 115	22,22	
					Fg.-Nr. P1000001→	DEL,JBH		0 986 480 131	22,2	













		S							
◀ OPEL Vectra [A]									
2.0 i	ABO	09.88-08.95	95			DEL	0986 480 115	22,22	
						JBH	ATE 0986 480 752	22,2	
2.0 i, i 4x4, i 16V	ABS	09.88-08.95	74-85/95/ 100/110			DEL, JBH	0986 480 129	22,2	
						JBH	ATE 0986 480 907	22	
2.0 i 4x4	ABO	01.89-08.95	85			DEL, JBH	0986 480 132	22,2	
						JBH	ATE 0986 480 752	22,2	
						Fg.-Nr. P1000001→	DEL, JBH	0986 480 131	22,2
			95			JBH	ATE 0986 480 752	22,2	
2.0 i 4x4 Turbo		09.92-08.95	150			JBH	ATE 0986 480 758	23,8	
2.0 i 16V	ABO	09.92-08.95	110			JBH	ATE 0986 480 752	22,2	
						Fg.-Nr. →N5999999	DEL	0986 480 115	22,22
						Fg.-Nr. P1000001→	DEL, JBH	0986 480 131	22,2
			11.93-08.95	100		AA, DEL, JBH	0986 480 132	22,2	
						AA, DEL, JBH	0986 480 131	22,2	
2.5 i		02.93-08.95	125			JBH, LLE	ATE 0986 480 758	23,8	
1.6 i, i KAT, S	ABS	09.88-08.95	52/55-60			RLE	ATE 0986 485 109		
1.7 D, TD	ABS	10.88-08.95	42/60			RLE	ATE 0986 485 109		
1.8, i	ABS	09.89-08.95	66			RLE	ATE 0986 485 109		
1.8 S	ABS	09.88-08.95	65			RLE	ATE 0986 485 109		
1.8 S 4x4		01.89-08.95	65			AA, RLE	ATE 0986 485 109		
1.8 4x4		09.89-08.95	66			AA, RLE	ATE 0986 485 109		
2.0 i	ABS	09.88-08.95	74-85			RLE	ATE 0986 485 109		
			95			RLE	ATE 0986 485 109		
2.0 i 4x4		01.89-08.95	85			AA, RLE	ATE 0986 485 109		
			95			AA, RLE	ATE 0986 485 109		
2.0 i 4x4 Turbo		09.92-08.95	150			AA, RLE	ATE 0986 485 109		
2.0 i 16V	ABS	09.92-08.95	100/110			RLE	ATE 0986 485 109		
2.5 i	ABS	02.93-08.95	125			RLE	ATE 0986 485 109		
1.6 i, i KAT, S		09.88-08.95	52/55-60	Fg.-Nr. →MV999999, →M1999999, →N5000039			0265 201 048 ^H		
				Fg.-Nr. NV000001→, 0→ N1000001→, N500004			0265 208 311 ^H		
1.7 D		10.88-08.95	42/60	Fg.-Nr. →MV999999, →M1999999, →N5000039			0265 201 048 ^H		
1.7 TD				Fg.-Nr. NV000001→, N1000001→, N5000040→			0265 208 311 ^H		
1.8, i, S, S 4x4, 4x4		09.88-08.95	65/66	Fg.-Nr. →MV999999, →M1999999, →N5000039			0265 201 048 ^H		
				Fg.-Nr. NV000001→, N1000001→, N5000040→			0265 208 311 ^H		
2.0 i, i 4x4, i 4x4 Turbo, i 16V		09.88-08.95	74-85/95/ 100/110/ 150	Fg.-Nr. →MV999999, →M1999999, →N5000039			0265 201 048 ^H		
				Fg.-Nr. NV000001→, N1000001→, N5000040→			0265 208 311 ^H		
2.5 i		02.93-08.95	125	Fg.-Nr. →MV999999, →M1999999, →N5000039			0265 201 048 ^H		
				Fg.-Nr. NV000001→, N1000001→, N5000040→			0265 208 311 ^H		
1.6 i		09.88-08.95	52/55-60	Fg.-Nr. →MV235527, →L1999999, →L5999999			0265 100 039 ^H		
1.6 i KAT									
1.6 S				Fg.-Nr. MV235528→MV999999, M1000001→M1999999, M5000001→N5000039			0265 103 038 ^H		
1.7 D		10.88-08.95	42/60	Fg.-Nr. →MV235527, →L1999999, →L5999999			0265 100 039 ^H		
1.7 TD				Fg.-Nr. MV235528→MV999999, M1000001→M1999999, M5000001→N5000039			0265 103 038 ^H		

		S							
1.8		09.88-08.95	65/66	Fg.-Nr. →MV235527, →L1999999, →L5999999		0 265 100 039^H			
1.8 i									
1.8 S				Fg.-Nr. MV235528→MV999999, M1000001→M1999999, M5000001→N5000039		0 265 103 038^H			
2.0 i		09.88-08.95	74-85/95/	Fg.-Nr. →MV235527, →L1999999, →L5999999		0 265 100 039^H			
2.0 i 16V			100/110						
				Fg.-Nr. MV235528→MV999999, M1000001→M1999999, M5000001→N5000039		0 265 103 038^H			

Vectra [B]

1.6 i		09.95-07.03	55/74	Fg.-Nr. →W1285446, →W5276825, →W7154258	JBH, LLE	0 986 480 684	22,2		
1.6 i 16V									
				Fg.-Nr. →W7999999, XL000001→	JBH, RLE	0 986 480 684	22,2		
				Fg.-Nr. W1285447→ W1999999, W7154259→ W7999999, XL000001→	JBH, LLE	0 986 480 010	20,64		
1.7 TD		09.95-09.98	60	Fg.-Nr. →W1285446, →W5276825, →W7154258	JBH, LLE	0 986 480 684	22,2		
				Fg.-Nr. →W7999999, XL000001→	JBH, RLE	0 986 480 684	22,2		
				Fg.-Nr. W1285447→ W1999999, W7154259→ W7999999, XL000001→	JBH, LLE	0 986 480 010	20,64		
1.8 i 16V		09.95-09.00	85	Fg.-Nr. →W1285446, →W5276825, →W7154258	JBH, LLE	0 986 480 684	22,2		
				Fg.-Nr. →W7999999, XL000001→	JBH, RLE	0 986 480 684	22,2		
				Fg.-Nr. W1285447 →W1999999, W7154259→ W7999999, XL000001→	JBH, LLE	0 986 480 010	20,64		
		03.01-09.02	92		JBH, LLE	0 986 480 493	20,64		
2.0 DI		09.95-08.03	60/74/82	Fg.-Nr. →W1285446, →W5276825, →W7154258	JBH, LLE	0 986 480 684	22,2		
2.0 DTI									
2.0 i				Fg.-Nr. →W7999999, XL000001→	JBH, RLE	0 986 480 684	22,2		
				Fg.-Nr. W1285447→ W1999999, W7154259→ W7999999, XL000001→	JBH, LLE	0 986 480 010	20,64		
2.0 i		09.95-09.02	100		HWL, JBH	0 986 480 929	22,2		
2.0 i 16V				Fg.-Nr. →W1285446, →W5276825, →W7154258	JBH, LLE	0 986 480 920	23,81		
					JBH, RLE	0 986 480 929	22,2		
2.2 DTI		09.00-09.03	92		JBH, LLE	0 986 480 493	20,64		
2.2 i		06.00-09.02	106		HWL, JBH	0 986 480 929	22,2		
					JBH, LLE	0 986 480 944	25,4		
2.2 i 16V		09.00-09.03	108		JBH, LLE	0 986 480 493	20,64		
2.5 i V6		09.95-09.00	125-143		HWL, JBH	0 986 480 929	22,2		
				Fg.-Nr. →W1285446, →W5276825, →W7154258	JBH, LLE	0 986 480 920	23,81		
				Fg.-Nr. W1285447→, W7154259→	JBH, RLE	0 986 480 929	22,2		
					JBH, LLE	0 986 480 944	25,4		
2.6 V6		09.00-09.02	130		HWL, JBH	0 986 480 929	22,2		
					JBH, LLE	0 986 480 944	25,4		
1.6 i		09.95-07.03	55/74	Fg.-Nr. W1285447→, W7154259→, XL470221→		0 986 486 095	15,87		
1.6 i 16V									
1.7 TD		09.95-09.98	60	Fg.-Nr. W1285447→, W7154259→		0 986 486 095	15,87		

			S								
◀ OPEL Vectra [B]											
	1.8 i 16V	09.95-09.00	85	Fg.-Nr. W1285447→, W7154259→, XL470221→				0986 486 095	15,87		
		09.98-08.00	85					0986 486 095	15,87		
		09.00-09.03	92					0986 486 095	15,87		
	2.0 DI	09.96-09.03	60/74	Fg.-Nr. W1285447→, W7154259→				0986 486 095	15,87		
	2.0 DTI										
	2.0 i	09.95-09.02	82/100	Fg.-Nr. W1285447→, W7154259→, XL470221→				0986 486 095	15,87		
	2.0 i 16V										
	2.2 DTI	09.00-09.03	92					0986 486 095	15,87		
	2.2 i	06.00-09.02	106	Fg.-Nr. W1285447→, W7154259→, XL470221→				0986 486 095	15,87		
	2.2 i 16V	09.00-09.03	108					0986 486 095	15,87		
	2.5 i V6	09.95-09.00	125-143	Fg.-Nr. W1285447→, W7154259→, XL470221→				0986 486 095	15,87		
	2.6 V6	09.00-09.02	130	Fg.-Nr. W1285447→, W7154259→, XL470221→				0986 486 095	15,87		
	1.6 i	09.95-07.03	55			F18		0986 486 593	34		
		09.96-07.03	55	Get.-Nr. F23				0986 486 588	31		
	1.6 i 16V	09.95-09.02	74	Get.-Nr. F23				0986 486 588	31		
	1.7 TD	09.95-09.98	60					0986 486 593	34		
	1.8 i 16V	09.95-09.00	85	Get.-Nr. F18				0986 486 593	34		
		09.98-08.00	85	Get.-Nr. F23				0986 486 588	31		
		09.00-09.03	92	Get.-Nr. F23				0986 486 588	31		
	2.0 DI, DTI	09.96-09.03	60/74			F18		0986 486 593	34		
	2.0 i, i 16V	09.95-09.02	82/100					0986 486 593	34		
	2.2 i	06.00-09.02	106			F18		0986 486 593	34		
	2.0 i	09.95-09.02	100	Fg.-Nr. →W1285446, →W5276825, →W7154258				0265 220 025 ^F			
				Fg.-Nr. W1285447→, W7154259→, WP000001→				0265 220 458 ^F			
	2.2 i	06.00-09.02	106					0265 220 458 ^F			
	2.2 i 16V	09.00-09.03	108					0265 220 583 ^F			
	2.5 i V6	09.95-09.00	125-143	Fg.-Nr. →W1285446, →W5276825, →W7154258				0265 220 025 ^F			
				Fg.-Nr. W1285447→, W7154259→, WP000001→				0265 220 458 ^F			
2.6 V6	09.00-09.02	130					0265 220 583 ^F				
Vectra [C]											
	1.6 i	MFD	09.01-10.08	74-77			JBH, LLE	LUC	0986 480 993	25,4	
		1.6 i GTS	OFD	09.01-10.08	74-77			JBH, RLE	LUC	0986 480 837	
	1.8 i	MFD	09.01-10.08	81/90/103				JBH, LLE	LUC	0986 480 993	25,4
		1.8 i GTS	OFD	09.01-10.08	81/90/103			JBH, RLE	LUC	0986 480 837	
	1.9 CDTI	MFD	04.04-10.08	74/88/110				JBH, LLE		0986 480 993	25,4
		1.9 CDTI GTS	OFD	04.04-10.08	74/88/110			JBH, RLE		0986 480 837	
	2.0 DTI	MFD	04.02-09.05	74				JBH, LLE	LUC	0986 480 993	25,4
		2.0 DTI GTS	OFD	04.02-09.05	74			JBH, RLE	LUC	0986 480 837	
	2.2 Direct, Direct GTS, DTI, DTI GTS, i, i GTS	MFD	09.01-10.08	86-92/108/ 110-114				JBH, LLE	LUC	0986 480 993	25,4
		OFD	09.01-10.08	86-92/108/ 110-114				JBH, RLE	LUC	0986 480 837	
	3.0 CDTI	MFD	03.03-10.08	130/135				JBH, LLE	LUC	0986 480 993	25,4
		3.0 CDTI GTS	OFD	03.03-10.08	130/135			JBH, RLE	LUC	0986 480 837	
			OFD	03.03-10.08	130/135			JBH, LLE	LUC	0986 480 858	25,4

		S							
3.2i		MFD	08.02-09.05	155		JBH,LLE	LUC	0 986 480 993	25,4
3.2i GTS						JBH,RLE	LUC	0 986 480 837	
		OFD	08.02-09.05	155		JBH,LLE	LUC	0 986 480 858	25,4
	1.6i, i GTS		09.01-10.08	74/77		LLE		0 986 486 110	15,87
	1.8i, i GTS		09.01-10.08	81/90/103		LLE		0 986 486 110	15,87
	1.9 CDTI, CDTI GTS		04.04-10.08	74/88/110		LLE		0 986 486 110	15,87
	2.0 DTI, DTI GTS, Turbo, Turbo GTS		04.02-10.08	74/129		LLE		0 986 486 110	15,87
	2.2 Direct, Direct GTS, DTI, DTI GTS, i, i GTS		09.01-10.08	86-92/108/ 110-114		LLE		0 986 486 110	15,87
	2.8 GTS Turbo, Turbo		08.05-10.08	169/184-188/206		LLE		0 986 486 110	15,87
	3.0 CDTI, CDTI GTS		03.03-10.08	130/135		LLE		0 986 486 110	15,87
	3.2i, i GTS		08.02-09.05	155		LLE		0 986 486 110	15,87
	1.6i, i GTS		09.01-10.08	74/77		F13		0 986 486 588	31
	1.8i, i GTS		09.01-10.08	81/90/103		F13		0 986 486 588	31
	1.9 CDTI, CDTI GTS		04.04-10.08	74/88/110		F13		0 986 486 588	31
	2.0 DTI, DTI GTS, Turbo, Turbo GTS		04.02-10.08	74/129		F13		0 986 486 588	31
	2.2 Direct, Direct GTS		09.03-10.08	110-114		F13		0 986 486 588	31
	2.2 DTI, DTI GTS		04.02-09.05	86-92		F13		0 986 486 588	31
	2.2i		09.01-09.05	108	Get.-Nr. F17	EAY, MG5, TW		0 986 486 588	31
					Get.-Nr. F40	MG6		0 986 486 579	34
	2.2i GTS		09.01-09.05	108		F13		0 986 486 588	31
	3.0 CDTI, CDTI GTS		03.03-10.08	130/135		F13		0 986 486 588	31
	3.2i, i GTS		08.02-09.05	155		F13		0 986 486 588	31
Vectra Caravan [B]									
									
	1.6i		09.95-07.02	55/74	Fg.-Nr. →W1285446,	JBH,LLE		0 986 480 684	22,2
	1.6i 16V				→W5276825, →W7154258				
					Fg.-Nr. →W7999999,	JBH,RLE		0 986 480 684	22,2
					XL000001→				
					Fg.-Nr. W1285447→	JBH,LLE		0 986 480 010	20,64
					W1999999, W7154259→				
					W7999999, XL000001→				
	1.7 TD		09.95-09.98	60	Fg.-Nr. →W1285446,	JBH,LLE		0 986 480 684	22,2
					→W5276825, →W7154258				
					Fg.-Nr. →W7999999,	JBH,RLE		0 986 480 684	22,2
					XL000001→				
					Fg.-Nr. W1285447→	JBH,LLE		0 986 480 010	20,64
					W1999999, W7154259→				
					W7999999, XL000001→				
	1.8i 16V		09.95-09.00	85	Fg.-Nr. →W1285446,	JBH,LLE		0 986 480 684	22,2
					→W5276825, →W7154258				
					Fg.-Nr. →W7999999,	JBH,RLE		0 986 480 684	22,2
					XL000001→				
					Fg.-Nr. W1285447→	JBH,LLE		0 986 480 010	20,64
					W1999999, W7154259→				
					W7999999, XL000001→				
			03.01-09.02	92		JBH,LLE		0 986 480 493	20,64
	2.0 DI		09.95-08.03	60/74/82	Fg.-Nr. →W1285446,	JBH,LLE		0 986 480 684	22,2
	2.0 DTI				→W5276825, →W7154258				
	2.0i				Fg.-Nr. →W7999999,	JBH,RLE		0 986 480 684	22,2
					XL000001→				
					Fg.-Nr. W1285447→	JBH,LLE		0 986 480 010	20,64
					W1999999, W7154259→				
					W7999999, XL000001→				
	2.0i		09.95-09.02	100		HWL, JBH		0 986 480 929	22,2
	2.0i 16V				Fg.-Nr. →W1285446,	JBH,LLE		0 986 480 920	23,81
					→W5276825, →W7154258	JBH,RLE		0 986 480 929	22,2
	2.2 DTI, i 16V		09.00-09.03	92/108		JBH,LLE		0 986 480 493	20,64



			S							
◀ OPEL Vectra Caravan [B]										
	2.5 iV6	09.96-06.00	125-143			HWL,JBH	0986 480 929	22,2		
					Fg.-Nr. →W1285446,	JBH,LLE	0986 480 920	23,81		
					→W5276825, →W7154258	JBH,RLE	0986 480 929	22,2		
					Fg.-Nr. W1285447→,	JBH,LLE	0986 480 944	25,4		
					W7154259→					
	2.6 V6	09.00-09.02	130			HWL,JBH	0986 480 929	22,2		
						JBH,LLE	0986 480 944	25,4		
	1.6 i	09.95-09.02	55/74		Fg.-Nr. W1285447→,		0986 486 095	15,87		
	1.6 i 16V				W7154259→, XL470221→					
	1.7 TD	09.95-09.98	60		Fg.-Nr. W1285447→, W7154259→		0986 486 095	15,87		
	1.8 i 16V	09.95-09.00	85		Fg.-Nr. W1285447→,		0986 486 095	15,87		
					W7154259→, XL470221→					
			09.98-08.00	85			0986 486 095	15,87		
			09.00-09.03	92			0986 486 095	15,87		
	2.0 DI, DTI	09.96-09.03	60/74		Fg.-Nr. W1285447→, W7154259→		0986 486 095	15,87		
	2.0 i	09.95-09.02	82/100		Fg.-Nr. W1285447→, W7154259→,		0986 486 095	15,87		
	2.0 i 16V				XL470221→					
	2.2 DTI, i 16V	09.00-09.03	92/108				0986 486 095	15,87		
	2.5 iV6	09.96-06.00	125-143		Fg.-Nr. W1285447→, W7154259→,		0986 486 095	15,87		
					XL470221→					
	2.6 V6	09.00-09.02	130		Fg.-Nr. W1285447→, W7154259→,		0986 486 095	15,87		
					XL470221→					
	1.6 i	09.95-07.00	55			F18	0986 486 593	34		
		09.96-09.00	55		Get.-Nr. F23		0986 486 588	31		
	1.6 i 16V	09.96-09.02	74		Get.-Nr. F23		0986 486 588	31		
	1.7 TD	09.95-09.98	60				0986 486 593	34		
	1.8 i 16V	09.95-09.00	85		Get.-Nr. F18		0986 486 593	34		
		09.98-08.00	85		Get.-Nr. F23		0986 486 588	31		
		09.00-09.03	92		Get.-Nr. F23		0986 486 588	31		
	2.0 DI, DTI	09.96-09.03	60/74			F18	0986 486 593	34		
	2.0 i, i 16V	09.95-09.02	82/100				0986 486 593	34		
	2.0 i	09.95-09.02	100		Fg.-Nr. →W1285446, →W5276825,		0 265 220 025 ^F			
	2.0 i 16V				→W7154258					
					Fg.-Nr. W1285447→, W7154259→,		0 265 220 458 ^F			
					WP000001→					
	2.2 i 16V	09.00-09.03	108				0 265 220 583 ^F			
2.5 iV6	09.96-06.00	125-143		Fg.-Nr. →W1285446, →W5276825,		0 265 220 025 ^F				
				→W7154258						
				Fg.-Nr. W1285447→, W7154259→,		0 265 220 458 ^F				
				WP000001→						
2.6 V6	09.00-09.02	130				0 265 220 583 ^F				
Vectra Caravan [C]										
	1.6 i	MFD 09.03-10.08	74-77			JBH,LLE LUC	0986 480 993	25,4		
						JBH,RLE LUC	0986 480 837			
		OFD 09.03-10.08	74-77			JBH,LLE LUC	0986 480 858	25,4		
	1.8 i	MFD 09.03-10.08	81/90/103			JBH,LLE LUC	0986 480 993	25,4		
						JBH,RLE LUC	0986 480 837			
		OFD 09.03-10.08	81/90/103			JBH,LLE LUC	0986 480 858	25,4		
	1.9 CDTI	MFD 04.04-10.08	74/88/110			JBH,LLE	0986 480 993	25,4		
						JBH,RLE	0986 480 837			
		OFD 04.04-10.08	74/88/110			JBH,LLE	0986 480 858	25,4		
	2.0 DTI	MFD 09.03-10.08	74/129			JBH,LLE LUC	0986 480 993	25,4		
	2.0 Turbo					JBH,RLE LUC	0986 480 837			
		OFD 09.03-10.08	74/129			JBH,LLE LUC	0986 480 858	25,4		
	2.2 Direct	MFD 09.03-10.08	86-92/108/110-114			JBH,LLE LUC	0986 480 993	25,4		
	2.2 DTI					JBH,RLE LUC	0986 480 837			
	2.2 i	OFD 09.03-10.08	86-92/108/110-114			JBH,LLE LUC	0986 480 858	25,4		

		S								
3.0 CDTI	MFD	09.03-10.08	130/135			JBH,LLE	LUC	0 986 480 993	25,4	
						JBH,RLE	LUC	0 986 480 837		
3.2 i	OFD	09.03-10.08	130/135			JBH,LLE	LUC	0 986 480 858	25,4	
	MFD	09.03-09.05	155			JBH,LLE	LUC	0 986 480 993	25,4	
						JBH,RLE	LUC	0 986 480 837		
	OFD	09.03-09.05	155			JBH,LLE	LUC	0 986 480 858	25,4	
	1.6 i	09.03-10.08	74-77			LLE		0 986 486 110	15,87	
	1.8 i	09.03-10.08	81/90/103			LLE		0 986 486 110	15,87	
	1.9 CDTI	04.04-10.08	74/88/110			LLE		0 986 486 110	15,87	
	2.0 DTI, Turbo	09.03-10.08	74/129			LLE		0 986 486 110	15,87	
	2.2 Direct, DTI, i	09.03-10.08	86-92/108/110-114			LLE		0 986 486 110	15,87	
	2.8 Turbo	08.05-10.08	169/184-188/206			LLE		0 986 486 110	15,87	
	3.0 CDTI	09.03-10.08	130/135			LLE		0 986 486 110	15,87	
	3.2 i	09.03-09.05	155			LLE		0 986 486 110	15,87	
		1.6 i	09.03-10.08	74-77			F13		0 986 486 588	31
1.8 i		09.03-10.08	81/90/103			F13		0 986 486 588	31	
1.9 CDTI		04.04-10.08	74/88/110			F13		0 986 486 588	31	
2.0 DTI, Turbo		09.03-10.08	74/129			F13		0 986 486 588	31	
2.2 Direct, DTI, i		09.03-10.08	86-92/108/ 110-114			F13		0 986 486 588	31	
3.0 CDTI		09.03-10.08	130/135			F13		0 986 486 588	31	
3.2 i		09.03-09.05	155			F13		0 986 486 588	31	
Vivaro										
	1.9 CDTI	MFD	03.01-08.06	60/74		JBH		0 986 480 827	25,4	
	1.9 DTI	OFD	03.01-08.06	60/74	Fg.-Nr. →4V602167	JBH,LLE		0 986 480 887	20,6	
						JBH,RLE		0 986 480 831	25,4	
					Fg.-Nr. 4V602168→	JBH,LLE		0 986 480 999	20,64	
						JBH,RLE		0 986 480 828	25,4	
2.0 CDTI	ABO	08.06→	66/84					0 986 481 052	20,6	
	ABS,	08.06→	66/84					0 986 481 050	20,6	
	OAS									
	ASR	08.06→	66/84					0 986 481 051	20,6	
2.0 16V	ABO	03.01→	86-88	Fg.-Nr. 7V600001→, 7Y000001→				0 986 481 052	20,6	
	ABS,	03.01→	86-88	Fg.-Nr. 7V600001→, 7Y000001→				0 986 481 050	20,6	
	OAS									
	ASR	03.01→	86-88	Fg.-Nr. →6V699999	JBH			0 986 480 827	25,4	
				Fg.-Nr. 7V600001→, 7Y000001→				0 986 481 051	20,6	
	OAS	03.01→	86-88	Fg.-Nr. →4V602167	JBH			0 986 480 831	25,4	
				Fg.-Nr. 4V602168→	JBH			0 986 480 828	25,4	
				6V699999						
2.5 CDTI	ABO	08.06→	107					0 986 481 052	20,6	
	ABS,	08.06→	107					0 986 481 050	20,6	
	OAS									
		ASR	08.06→	107					0 986 481 051	20,6
		MFD	09.02-08.06	99			JBH		0 986 480 827	25,4
		OAS	09.02-08.06	99	Fg.-Nr. →4V602167	JBH			0 986 480 831	25,4
	OFD	09.02-08.06	99	Fg.-Nr. 4V602168→	JBH			0 986 480 828	25,4	
	1.9 CDTI, DTI	03.01-08.06	60/74			LLE		0 986 486 147	15,87	
	2.0 CDTI	08.06→	66/84	Fg.-Nr. →6V999999, →6Y999999		LLE		0 986 486 147	15,87	
				Fg.-Nr. 7V000001→, 7Y000001→		LLE		0 986 486 147	15,87	
			12.10→	66/84			LLE		0 986 486 147	15,87
2.0 16V		03.01→	86-88	Fg.-Nr. →6V999999, →6Y999999		LLE		0 986 486 147	15,87	
				Fg.-Nr. 7V000001→, 7Y000001→		LLE		0 986 486 147	15,87	

		S							
◀ OPEL Vivaro									
	2.5 CDTI	09.02-06.08	84/99			LLE	0986 486 147	15,87	
		08.06→	107	Fg.-Nr. →6V999999, →6Y999999		LLE	0986 486 147	15,87	
				Fg.-Nr. 7V000001→, 7Y000001→		LLE	0986 486 147	15,87	
Zafira [A]									
	1.6 i	MFD	03.99-07.05	69-73/74		JBH	0986 481 028	23,81	
	1.6 i CNG	OFD	03.99-07.05	69-73/74		JBH	0986 480 699	23,8	
	1.8 i	MFD	03.99-07.05	85/92		JBH	0986 481 028	23,81	
		OFD	03.99-07.05	85/92		JBH	0986 480 699	23,8	
	2.0 DI, DTI, Turbo	MFD	03.99-07.05	60/74/141-147		JBH	0986 481 028	23,81	
		OFD	03.99-07.05	60/74/141-147		JBH	0986 480 699	23,8	
	2.2	MFD	09.00-07.05	92/108		JBH	0986 481 028	23,81	
	2.2 DTI	OFD	09.00-07.05	92/108		JBH	0986 480 699	23,8	
	1.6 i, i CNG		03.99-07.05	69-73/74		LLE	0986 486 063	15,87	
	1.8 i		03.99-07.05	85/92		LLE	0986 486 063	15,87	
	2.0 DI, DTI, Turbo		03.99-07.05	60/74/141-147		LLE	0986 486 063	15,87	
	2.2, DTI		09.00-07.05	92/108		LLE	0986 486 063	15,87	
	1.6 i		03.99-07.05	74		F13	0986 486 588	31	
	1.8 i		03.99-07.05	85/92		F13	0986 486 588	31	
	2.0 DI		03.99-07.05	60/74		F18	0986 486 593	34	
	2.0 DTI								
	2.2		09.00-07.05	108		F18	0986 486 593	34	
	1.6 i, i CNG		03.99-07.05	69-73/74			0265 216 652 ^B		
	1.8 i		03.99-08.00	85			0265 202 458 ^T		
							0265 216 652 ^B		
							0265 220 532 ^F		
			09.00-07.05	92	Fg.-Nr. →12999999, →1H999999		0265 220 585 ^B		
					Fg.-Nr. 2H000001→		0265 220 637 ^F		
					Fg.-Nr. 2H000001→2H999999		0265 202 492 ^T		
					Fg.-Nr. 3H000001→		0265 202 509 ^T		
	2.0 DI, DTI		03.99-07.05	60/74			0265 216 652 ^B		
	2.0 Turbo		09.01-07.05	141-147	Fg.-Nr. →12999999, →1H999999		0265 220 585 ^B		
					Fg.-Nr. 2H000001→		0265 220 637 ^F		
					Fg.-Nr. 2H000001→2H999999		0265 202 492 ^T		
					Fg.-Nr. 3H000001→		0265 202 509 ^T		
	2.2		09.00-07.05	108	Fg.-Nr. →12999999, →1H999999		0265 220 585 ^B		
					Fg.-Nr. 2H000001→		0265 220 637 ^F		
					Fg.-Nr. 2H000001→2H999999		0265 202 492 ^T		
					Fg.-Nr. 3H000001→		0265 202 509 ^T		
	2.2 DTI		03.02-07.05	92	Fg.-Nr. 2H000001→		0265 220 637 ^F		
					Fg.-Nr. 2H000001→2H999999		0265 202 492 ^T		
					Fg.-Nr. 3H000001→		0265 202 509 ^T		
	1.8 i		09.00-07.05	92			0265 005 262		
	2.0 Turbo		09.01-07.05	141-147			0265 005 262		
	2.2, DTI		09.00-07.05	92/108			0265 005 262		
	1.8 i		03.99-08.00	85	Fg.-Nr. →Y2999999, →YH999999		0265 005 433		
			09.00-07.05	92			0265 005 435		
	2.0 Turbo		09.01-07.05	141-147			0265 005 435		
	2.2, DTI		09.00-07.05	92/108			0265 005 435		
	1.8 i		03.99-07.05	85/92			0265 005 303		
	2.0 Turbo		09.01-07.05	141-147			0265 005 303		
	2.2, DTI		09.00-07.05	92/108			0265 005 303		



Zafira [B]

	1.6 i	03.07→	85		RLE	0 986 481 059	25,4
	1.8 i, LPG	09.09→	88/101-103		RLE	0 986 481 059	25,4
	2.0 i Turbo	07.05-12.10	147/177	Fg.-Nr. →62999999, →6G999999	JBH,RLE	0 986 480 856	25,4
				Fg.-Nr. 72000001→, 7G000001→	RLE	0 986 481 059	25,4
	1.6 CNG, CNG Turbo, i	07.05→	69-71/77/85/110		LLE	0 986 486 063	15,87
	1.7 CDTI	03.08→	81/92		LLE	0 986 486 063	15,87
	1.8 i, LPG	07.05→	88/101-103		LLE	0 986 486 063	15,87
	1.9 CDTI	07.05-12.10	74/88/110		LLE	0 986 486 063	15,87
	2.0 i Turbo	07.05-12.10	147/177		LLE	0 986 486 063	15,87
	2.2 i Direct	07.05-12.10	110		LLE	0 986 486 063	15,87
	1.6 CNG Turbo	03.09→	110		EAY	0 986 486 588	31
					MG5	0 986 486 588	31
					MG6	0 986 486 591	34
	1.6 CNG, i	07.05→	69-71/77/85			0 986 486 588	31
	1.7 CDTI	03.08-07.12	81			0 986 486 588	31
		03.08→	81		EAY, MG5	0 986 486 588	31
					MG6	0 986 486 594	34
			92		EAY, MG5	0 986 486 588	31
					MG6	0 986 486 594	34
	1.8 i, LPG	07.05→	88/101-103			0 986 486 588	31
	1.9 CDTI	07.05-12.10	74/88/110		TW	0 986 486 588	31
						0 986 486 590	34
	2.0 i Turbo	07.05-12.10	147		EAY, MG5	0 986 486 588	31
				Get.-Nr. M32	MG6	0 986 486 591	34
		01.06-12.10	177		EAY	0 986 486 588	31
				Get.-Nr. F17	MG5	0 986 486 588	31
				Get.-Nr. M32	MG6	0 986 486 590	34
	2.2 i Direct	07.05-12.10	110		EAY, MG5	0 986 486 588	31
				Get.-Nr. M32	MG6	0 986 486 591	34

PEUGEOT

Boxer

	2.8 D, D Turbo, HDI	ABO 01.02-09.09	66/77/93			0 204 123 616	25,4
					JBH, L02, LLE	F 026 003 313	25,4
		ABS 01.02-09.09	66/77/93			0 204 123 615	25,4
	2.8 D	01.02-09.09	66/77/93			0 204 125 801	
	2.8 D Turbo			Fg.-Nr. →15064995	L03	0 204 125 445	
	2.8 HDI			Fg.-Nr. →15984271	L02	0 204 125 746	
				Fg.-Nr. 15984272→		0 204 125 772	
	2.8 D, D Turbo, HDI	01.02-09.09	66/77/93	Fg.-Nr. 15445358→	L02	0 265 216 530^B	
					L03	0 265 216 436^B	

Boxer [U3]

	1.9 D	ABO 07.98-02.02	50		JBH, L02, LLE	F 026 003 313	25,4
					L02, RLE	0 204 123 314	25,4
					L03, RLE	0 204 123 325	23,8
		ABS 07.98-02.02	50			F 026 003 315	25,4





◀ PEUGEOT Boxer [U3]							
1.9 D 1.9 D Turbo	ABO	02.94-12.94	51/66/68		JBH,L03,LLE	F 026 003 318	22,2
					L03,RLE	0 204 123 319	22,2
		02.94-02.02	51/66/68		JBH,L02,LLE	F 026 003 313	25,4
					L02,RLE	0 204 123 314	25,4
		01.95-02.02	51/66/68		L03,RLE	0 204 123 325	23,8
ABS	02.94-12.94	51/66/68			L03	0 204 123 320	22,2
	02.94-02.02	51/66/68				F 026 003 315	25,4
2.0 2.0 i	ABO	02.94-12.94	79/80-81		JBH,L03,LLE	F 026 003 318	22,2
					L03,RLE	0 204 123 319	22,2
		02.94-02.02	79/80-81		JBH,L02,LLE	F 026 003 313	25,4
					L02,RLE	0 204 123 314	25,4
		01.95-02.02	79/80-81		L03,RLE	0 204 123 325	23,8
ABS	02.94-12.94	79/80-81			L03	0 204 123 320	22,2
	02.94-02.02	79/80-81				F 026 003 315	25,4
2.0 HDi	ABO	09.01-02.02	62		JBH,L02,LLE	F 026 003 313	25,4
					L02,RLE	0 204 123 314	25,4
					L03,RLE	0 204 123 325	23,8
ABS	09.01-02.02	62			F 026 003 315	25,4	
2.5 D	ABO	01.99-02.02	62		JBH,L02,LLE	F 026 003 313	25,4
					L02,RLE	0 204 123 314	25,4
					L03,RLE	0 204 123 325	23,8
ABS	01.99-02.02	62			F 026 003 315	25,4	
2.5 D 2.5 D Turbo	ABO	02.94-12.94	63/76-77		JBH,L03,LLE	F 026 003 318	22,2
					L03,RLE	0 204 123 319	22,2
		02.94-02.02	63/76-77		JBH,L02,LLE	F 026 003 313	25,4
					L02,RLE	0 204 123 314	25,4
		01.95-02.02	63/76-77		L03,RLE	0 204 123 325	23,8
ABS	02.94-12.94	63/76-77			L03	0 204 123 320	22,2
	02.94-02.02	63/76-77				F 026 003 315	25,4
2.5 TDi	ABO	10.96-02.02	79-81		JBH,L02,LLE	F 026 003 313	25,4
					L02,RLE	0 204 123 314	25,4
					L03,RLE	0 204 123 325	23,8
ABS	10.96-02.02	79-81			F 026 003 315	25,4	
2.8 D, D Turbo, HDi	ABO	01.99-02.02	64/90/94		JBH,L02,LLE	F 026 003 313	25,4
					L02,RLE	0 204 123 314	25,4
					L03,RLE	0 204 123 325	23,8
ABS	01.99-02.02	64/90/94			F 026 003 315	25,4	

1.9 D 1.9 D Turbo	02.94-02.02	50/51/66/	Fg.-Nr. →15064995	L03	0 204 125 445
		68	Fg.-Nr. →15984271	L02,LLE	0 204 125 746
			Fg.-Nr. 15064996→	L03,LLE	0 204 125 746
			15984271		
			Fg.-Nr. 15687087→	RLE	0 204 125 746
		15984271			
		Fg.-Nr. 15984272→	LLE	0 204 125 772	
			L02,RLE	0 204 125 772	
			L03,RLE	0 204 125 773	
2.0 2.0 i	02.94-02.02	79/80-81	Fg.-Nr. →15064995	L03	0 204 125 445
			Fg.-Nr. →15984271	L02	0 204 125 746
			Fg.-Nr. 15064996→	L03	0 204 125 746
			15984271		
			Fg.-Nr. 15984272→		0 204 125 772
2.0 HDi	09.01-02.02	62	Fg.-Nr. →15984271		0 204 125 746
			Fg.-Nr. 15984272→		0 204 125 772
2.5 D	01.99-02.02	62	Fg.-Nr. →15984271		0 204 125 746
			Fg.-Nr. 15984272→		0 204 125 772
2.5 D 2.5 D Turbo	02.94-02.02	63/76-77	Fg.-Nr. →15064995	L03	0 204 125 445
			Fg.-Nr. →15984271	L02	0 204 125 746
			Fg.-Nr. 15064996→	L03	0 204 125 746
			15984271		
			Fg.-Nr. 15984272→		0 204 125 772
2.5 TDi	10.96-02.02	79-81	Fg.-Nr. →15984271		0 204 125 746
			Fg.-Nr. 15984272→		0 204 125 772

		S							
2.8 D, D Turbo, HDi		01.99-02.02	64/90/94	Fg.-Nr. →15984271 Fg.-Nr. 15984272→			0 204 125 746 0 204 125 772		
1.9 D	ABO	02.94-02.02	50/51/66/68				0 204 131 232 ^A		
1.9 D Turbo	ABS	02.94-06.97	51/66/68	Fg.-Nr. →15445357			0 204 131 217 ^A		
2.0	ABO	02.94-02.02	79/80-81				0 204 131 232 ^A		
2.0 i	ABS	02.94-06.97	79/80-81	Fg.-Nr. →15445357			0 204 131 217 ^A		
2.5 D, D Turbo, TDi	ABO	02.94-02.02	62/63/76-77/ 79-81				0 204 131 232 ^A		
	ABS	02.94-06.97	63/76-77/ 79-81	Fg.-Nr. →15445357			0 204 131 217 ^A		
2.8 D, D Turbo	ABO	01.99-02.02	64/90				0 204 131 232 ^A		
1.9 D		02.94-02.02	50/51/66/ 68	Fg.-Nr. 15445358→	L02		0 265 216 530 ^B		
1.9 D Turbo					L03		0 265 216 436 ^B		
2.0, HDi, i		02.94-02.02	62/79/ 80-81	Fg.-Nr. 15445358→	L02		0 265 216 530 ^B		
					L03		0 265 216 436 ^B		
2.5 D, D Turbo, TDi		02.94-02.02	62/63/ 76-77/79-81	Fg.-Nr. 15445358→	L02		0 265 216 530 ^B		
					L03		0 265 216 436 ^B		
2.8 D, D Turbo, HDi		01.99-02.02	64/90/94	Fg.-Nr. 15445358→	L02		0 265 216 530 ^B		
					L03		0 265 216 436 ^B		
1.9 D		02.94-02.02	50/51/66/ 68	Fg.-Nr. 15445358→	L03		1 273 004 168 ^H		
1.9 D Turbo									
2.0, HDi, i		02.94-02.02	62/79/ 80-81	Fg.-Nr. 15445358→	L03		1 273 004 168 ^H		
2.5 D		02.94-02.02	62/63/ 76-77/ 79-81	Fg.-Nr. 15445358→	L03		1 273 004 168 ^H		
2.5 D Turbo									
2.5 TDi									
2.8 D, D Turbo, HDi		01.99-02.02	64/90/94	Fg.-Nr. 15445358→	L03		1 273 004 168 ^H		
Boxer [U5]									
2.0 HDi	ABO	02.02-05.06	62/80-81				0 204 123 616	25,4	
2.0 i	ABS	02.02-05.06	62/80-81				0 204 123 615	25,4	
2.2 HDi	ABO	02.02-05.06	74				0 204 123 616	25,4	
	ABS	02.02-05.06	74				0 204 123 615	25,4	
2.3 HDi	ABO	02.02-05.06	81				0 204 123 616	25,4	
	ABS	02.02-05.06	81				0 204 123 615	25,4	
2.8 D Turbo	ABO	02.02-05.06	90/94/107				0 204 123 616	25,4	
2.8 HDi	ABS	02.02-05.06	90/94/107				0 204 123 615	25,4	
2.0 HDi		02.02-05.06	62/80-81				0 204 125 801		
2.0 i									
2.2 HDi		02.02-05.06	74				0 204 125 801		
2.3 HDi		02.02-05.06	81				0 204 125 801		
2.8 D Turbo, HDi		02.02-05.06	90/94/107				0 204 125 801		
2.0 HDi		02.02-05.06	62			FGN,L02	0 204 031 185 ^A		
						L02,VFG	0 204 031 202 ^A		
						L06	0 204 031 182 ^A		
						L07,VFG	0 204 031 184 ^A		
2.0 i		02.02-05.06	80-81			FGN,L02	0 204 031 185 ^A		
						FGN,L07	0 204 031 183 ^A		
						L02,VFG	0 204 031 202 ^A		
						L06	0 204 031 182 ^A		
						L07,VFG	0 204 031 184 ^A		
2.2 HDi		02.02-05.06	74			FGN,L02	0 204 031 185 ^A		
						FGN,L07	0 204 031 183 ^A		
						L02,VFG	0 204 031 202 ^A		
						L06	0 204 031 182 ^A		
						L07,VFG	0 204 031 184 ^A		



PEUGEOT Boxer [U5]									
2.3 HDi		02.02-05.06		81		FGN,L02		0 204 031 185 ^A	
						FGN,L07		0 204 031 183 ^A	
						L02,VFG		0 204 031 202 ^A	
						L06		0 204 031 182 ^A	
						L07,VFG		0 204 031 184 ^A	
2.8 D Turbo		02.02-05.06		90/94/107		FGN,L02		0 204 031 185 ^A	
2.8 HDi						FGN,L07		0 204 031 183 ^A	
						L02,VFG		0 204 031 202 ^A	
						L06		0 204 031 182 ^A	
						L07,VFG		0 204 031 184 ^A	
Boxer [U9]									
2.2 HDi		MFD 06.06→		74/81/88/		2X6,G12,L07		0 204 123 721	
				95/96/110		2X8,G12,L20		0 204 123 719	
		OFD 06.06→		74/81/88/		2X6,G10,L07		0 204 123 718	
				95/96/110		2X8,G10,L20		0 204 123 720	
3.0 HDi		MFD 06.06→		107/115/		2X6,G12,L07		0 204 123 721	
				116/130		2X8,G12,L20		0 204 123 719	
		OFD 06.06→		107/115/		2X6,G10,L07		0 204 123 718	
				116/130		2X8,G10,L20		0 204 123 720	
Expert [G9]									
1.6 HDi		02.07-07.08		66		Org.-Nr. →11556		0 265 234 213 ^T	
		08.08-06.10		66		Org.-Nr. 11557→12256		0 265 251 176 ^T	
2.0 HDi		04.10-06.10		120		Org.-Nr. →12256		0 265 251 176 ^T	
2.0 HDi		02.07-07.08		88/100/103		Org.-Nr. →11556		0 265 234 213 ^T	
2.0 16V		08.08-06.10		88/100/103		Org.-Nr. 11557→12256		0 265 251 176 ^T	
1.6 HDi		02.07-11.07		66		Org.-Nr. →11318		0 265 005 606	
		12.07-07.08		66		Org.-Nr. 11319→11556		0 265 005 724	
		08.08→		66		Org.-Nr. 11557→		0 265 005 765	
		12.10→		66				0 265 005 765	
2.0 HDi		02.07-11.07		88		Org.-Nr. →11318		0 265 005 606	
		12.07-07.08		88		Org.-Nr. 11319→11556		0 265 005 724	
		08.08→		88		Org.-Nr. 11557→		0 265 005 765	
		04.10→		120				0 265 005 765	
		07.11→		72				0 265 005 765	
				94				0 265 005 765	
2.0 HDi		02.07-11.07		100/103		Org.-Nr. →11318		0 265 005 606	
2.0 16V		12.07-07.08		100/103		Org.-Nr. 11319→11556		0 265 005 724	
		08.08→		100/103		Org.-Nr. 11557→		0 265 005 765	
Expert [U64]									
1.6 i		ABO 09.95-05.99		58		Org.-Nr. →8206		0 204 124 073 ⁶	
						JBH		F 026 003 166	
		09.95-05.00		58				23,8	
						JBH		F 026 003 188	
		06.99-05.00		58		Org.-Nr. 8207→		22,2	
						JBH		F 026 003 517	
		ABS 09.95-05.99		58		Org.-Nr. →8206		23,81	
								0 204 123 182	
								23,8	
						JBH		F 026 003 518	
								22,2	
		06.99-05.00		58		Org.-Nr. 8207→		23,81	
						JBH		F 026 003 516	
								22,2	
								F 026 003 518	
1.8 i		ABO 09.96-05.99		70		Org.-Nr. →8206		0 204 124 073 ⁶	
						JBH		F 026 003 166	
		09.96-01.07		70				23,8	
						JBH		F 026 003 188	
								22,2	

		S							
1.8 i	ABO	06.99-01.07	70	Org.-Nr. 8207→	JBH	F 026 003 517	23,81		
	ABS	09.96-05.99	70	Org.-Nr. →8206		0 204 123 182	23,8		
		09.96-01.07	70						0 204 124 136 ⁶
		06.99-01.07	70	Org.-Nr. 8207→	JBH	F 026 003 518	22,2		
1.9 D	ABO	09.95-05.99	51-52	Org.-Nr. →8206	JBH	F 026 003 516	23,81		0 204 124 073 ⁶
		09.95-08.01	51-52		JBH	F 026 003 166	23,8		0 204 124 059 ⁶
		06.99-08.01	51-52	Org.-Nr. 8207→	JBH	F 026 003 188	22,2		
		06.99-08.01	51-52	Org.-Nr. 8207→	JBH	F 026 003 517	23,81		
		09.01-01.07	52		JBH	F 026 003 188	22,2		
						F 026 003 517	23,81		
	ABS	09.95-05.99	51-52	Org.-Nr. →8206		0 204 123 182	23,8		0 204 124 136 ⁶
		06.99-08.01	51-52	Org.-Nr. 8207→	JBH	F 026 003 518	22,2		
		06.99-08.01	51-52	Org.-Nr. 8207→	JBH	F 026 003 516	23,81		
		09.01-01.07	52		JBH	F 026 003 518	22,2		
1.9 D Turbo	ABO	09.95-07.98	68						0 204 124 059 ⁶
					JBH	F 026 003 166	23,8		0 204 124 073 ⁶
						F 026 003 188	22,2		
		09.95-05.99	66-68	Org.-Nr. →8206	JBH	F 026 003 166	23,8		0 204 124 073 ⁶
		09.95-05.00	66-68		JBH	F 026 003 188	22,2		0 204 124 059 ⁶
		06.99-05.00	66-68	Org.-Nr. 8207→	JBH	F 026 003 517	23,81		
	ABS	09.95-07.98	68			0 204 123 182	23,8		0 204 124 136 ⁶
					JBH	F 026 003 518	22,2		
		09.95-05.99	66-68	Org.-Nr. →8206		0 204 123 182	23,8		0 204 124 136 ⁶
					JBH	F 026 003 518	22,2		
2.0 HDi 2.0 i 16V	ABO	10.99-01.07	70/80/81/100		JBH	F 026 003 517	23,81		
	ABS	10.99-01.07	70/80/81/100		JBH	F 026 003 516	23,81		
	1.6 i	09.95-05.00	58		B2D,FCC	0 204 125 715			
					FCC,LLE	0 204 125 714			
					RLE	0 204 125 109			
	1.8 i	09.96-01.07	70		B2D,FCC	0 204 125 715			
					FCC,LLE	0 204 125 714			
					RLE	0 204 125 109			
	1.9 D 1.9 D Turbo	09.95-01.07	51-52/ 66-68		B2D,FCC	0 204 125 715			
					FCC,LLE	0 204 125 714			
					RLE	0 204 125 109			
	2.0 HDi 2.0 i 16V	10.99-01.07	70/80/81/ 100		B2D,FCC	0 204 125 715			
				FCC,LLE	0 204 125 714				
				RLE	0 204 125 109				
	1.6 i	09.95-05.00	58			0 204 131 085 ^A			
	1.8 i	09.96-01.07	70			0 204 131 085 ^A			
	1.9 D, D Turbo	09.95-01.07	51-52/66-68			0 204 131 085 ^A			
	2.0 HDi, i 16V	10.99-01.07	70/80/81/100			0 204 131 085 ^A			
	1.6 i	06.97-12.99	58	Org.-Nr. 7481→8420		0 265 216 496 ^B			
		01.00-05.00	58	Org.-Nr. 8421→		0 265 216 725 ^B			
	1.8 i	06.97-12.99	70	Org.-Nr. 7481→8420		0 265 216 496 ^B			
		01.00-01.07	70	Org.-Nr. 8421→		0 265 216 725 ^B			





PEUGEOT Expert [U64]						
1.9 D	06.97-12.99	51-52	Org.-Nr. 7481→8420			0 265 216 496^B
	01.00-08.01	51-52	Org.-Nr. 8421→			0 265 216 725^B
	09.01-01.07	52				0 265 216 725^B
1.9 D Turbo	06.97-07.98	68	Org.-Nr. 7481→			0 265 216 496^B
	06.97-12.99	66-68	Org.-Nr. 7481→8420			0 265 216 496^B
	01.00-05.00	66-68	Org.-Nr. 8421→			0 265 216 725^B
2.0 HDi	10.99-12.99	70/80	Org.-Nr. 7481→8420			0 265 216 496^B
	01.00-01.07	70/80	Org.-Nr. 8421→			0 265 216 725^B
2.0 HDi, i 16V	03.00-01.07	81/100				0 265 216 725^B

P 4

	1.2	10.86-12.96	36			0 204 163 020
	2.5 D	10.86-12.96	56			0 204 163 020

Partner

	1.8 i	ABO 10.99-12.03	66			0 204 123 373 23,81
		ABS 10.99-12.03	66			F 026 003 350 23,81
	1.9 D	ABO 10.99→	51			0 204 123 373 23,81
	1.8 i	07.00-12.03	66	Org.-Nr. 8610→	BO	0 204 125 764
	1.8 i	10.99-12.03	66		FEN,KOB	0 986 482 029^A
					FEN,LWG	0 986 482 030^A
	1.8 i	10.99-12.03	66			0 265 216 721^B
	2.0 HDi	05.02-08.06	66			0 265 216 484^B
	1.8 i	10.99-12.03	66		TEI	0 273 004 112^H

Partner [B9]

	1.6 BlueHDi, HDi	05.08→	55			0 986 486 616 19
	1.6 BlueHDi, HDi, VTi, 16V	05.08→	72/73/80-81/82/84/88			0 986 486 616 19
	1.6 HDi	05.08→	66/68			0 986 486 616 19
		07.10→	66/68	GS		0 986 486 616 19
	1.6 16V	05.08-02.12	66/68			0 986 486 616 19
	1.6 HDi	05.08-10.08	55/66/80-81	Org.-Nr. →11682		0 265 232 520^B
	1.6 16V	05.08-11.08	55/66/80-81	Org.-Nr. →11682	TW	0 265 230 509^T
	1.6 HDi	05.08-11.08	55/66/80-81	Org.-Nr. →11682		0 265 005 715
	1.6 16V					

Partner [M4]

	Electrique	ABO 01.98-06.00	24	Org.-Nr. →8609		0 204 124 073⁶	
					JBH	F 026 003 190 23,8	
			07.00-08.02	24	Org.-Nr. 8610→		0 204 123 373 23,81
		ABS 01.98-06.00	24	Org.-Nr. →8609	JBH,LLE	F 026 003 192 23,8	
			07.00-08.02	24	Org.-Nr. 8610→	RLE	0 204 123 341 23,8
					F 026 003 350 23,81		

		S								
1.1i	ABO	07.96-06.00	44	Org.-Nr. →8609					0 204 124 073 ⁶	
					JBH	F 026 003 190	23,8			
		07.00-08.02	44	Org.-Nr. 8610→			0 204 123 373	23,81		
		09.00-08.02	44				0 204 123 373	23,81		
	ABS	07.96-06.00	44	Org.-Nr. →8609		JBH,LLE	F 026 003 192	23,8		
						RLE	0 204 123 341	23,8		
1.4	ABO	11.96-06.00	51-52	Org.-Nr. →8609					0 204 124 073 ⁶	
					JBH	F 026 003 190	23,8			
		07.00-08.02	51-52	Org.-Nr. 8610→			0 204 123 373	23,81		
	ABS	11.96-06.00	51-52	Org.-Nr. →8609		JBH,LLE	F 026 003 192	23,8		
						RLE	0 204 123 341	23,8		
		07.00-08.02	51-52	Org.-Nr. 8610→			F 026 003 350	23,81		
1.4i	ABO	07.96-06.00	55	Org.-Nr. →8609					0 204 124 073 ⁶	
					JBH	F 026 003 190	23,8			
		07.00-08.02	55	Org.-Nr. 8610→			0 204 123 373	23,81		
		09.00-08.02	55				0 204 123 373	23,81		
	ABS	07.96-06.00	55	Org.-Nr. →8609		JBH,LLE	F 026 003 192	23,8		
						RLE	0 204 123 341	23,8		
1.6i 16V	ABO	09.00-08.02	80							
							0 204 123 373	23,81		
	ABS	09.00-08.02	80							
							F 026 003 350	23,81		
1.8D	ABO	07.96-06.00	43-44/66	Org.-Nr. →8609					0 204 124 073 ⁶	
					JBH	F 026 003 190	23,8			
		07.00-08.02	43-44/66	Org.-Nr. 8610→			0 204 123 373	23,81		
	ABS	07.96-06.00	43-44/66	Org.-Nr. →8609		JBH,LLE	F 026 003 192	23,8		
						RLE	0 204 123 341	23,8		
		07.00-08.02	43-44/66	Org.-Nr. 8610→			F 026 003 350	23,81		
1.9D	ABO	07.96-06.00	50/51	Org.-Nr. →8609					0 204 124 073 ⁶	
					JBH	F 026 003 190	23,8			
		07.00-08.02	50/51	Org.-Nr. 8610→			0 204 123 373	23,81		
		09.00-08.02	52				0 204 123 373	23,81		
	ABS	07.96-06.00	50/51	Org.-Nr. →8609		JBH,LLE	F 026 003 192	23,8		
						RLE	0 204 123 341	23,8		
2.0 HDi	ABO	12.99-08.02	66							
							0 204 123 373	23,81		
	ABS	12.99-08.02	66							
							F 026 003 350	23,81		
Electrique		01.98-06.00	24	Org.-Nr. →8609					0 204 125 134	
		07.00-08.02	24	Org.-Nr. 8610→		BO			0 204 125 764	
	1.1i	07.96-06.00	44	Org.-Nr. →8609						0 204 125 134
		07.00-08.02	44	Org.-Nr. 8610→			BO			0 204 125 764
		09.00-08.02	44				BO			0 204 125 764
	1.4	11.96-06.00	51-52	Org.-Nr. →8609						0 204 125 134
		07.00-08.02	51-52	Org.-Nr. 8610→			BO			0 204 125 764
	1.4i	07.96-06.00	55	Org.-Nr. →8609						0 204 125 134
		07.00-08.02	55	Org.-Nr. 8610→			BO			0 204 125 764
		09.00-08.02	55				BO			0 204 125 764
	1.6i 16V	09.00-08.02	80						0 204 125 764	
	1.8D	07.96-06.00	43-44/66	Org.-Nr. →8609					0 204 125 134	
	1.8i	07.00-08.02	43-44/66	Org.-Nr. 8610→			BO		0 204 125 764	
	1.9D	07.96-06.00	50/51	Org.-Nr. →8609						0 204 125 134
		07.00-08.02	50/51	Org.-Nr. 8610→			BO			0 204 125 764
09.00-08.02		52				BO			0 204 125 764	
2.0 HDi	12.99-08.02	66						0 204 125 514		
Electrique		01.98-08.02	24						0 986 482 031 ^A	
	1.1i	07.96-08.02	44			FEN,KOB			0 986 482 029 ^A	
						FEN,LWG			0 986 482 030 ^A	
						L01,LWG			0 986 482 031 ^A	





PEUGEOT Partner [M4]

1.4	07.96-08.02	51-52/55	FEN,KOB	0 986 482 029 ^A
1.4 i			FEN,LWG	0 986 482 030 ^A
			L01,LWG	0 986 482 031 ^A
1.6 i 16V	09.00-08.02	80	FEN,KOB	0 986 482 029 ^A
			FEN,LWG	0 986 482 030 ^A
			L01,LWG	0 986 482 031 ^A
1.8 D	07.96-08.02	43-44/66	FEN,KOB	0 986 482 029 ^A
1.8 i			FEN,LWG	0 986 482 030 ^A
			L01,LWG	0 986 482 031 ^A
1.9 D	07.96-08.02	50	FEN,KOB	0 986 482 029 ^A
			FEN,LWG	0 986 482 030 ^A
		51	FEN,KOB	0 986 482 029 ^A
			FEN,LWG	0 986 482 030 ^A
			L01,LWG	0 986 482 031 ^A
	09.00-08.02	52	FEN,KOB	0 986 482 029 ^A
			FEN,LWG	0 986 482 030 ^A
2.0 HDi	12.99-08.02	66	FEN,KOB	0 986 482 029 ^A
			FEN,LWG	0 986 482 030 ^A

Electric

1.1 i	01.98-08.02	24		0 265 216 721 ^B
1.4, i	07.96-08.02	44		0 265 216 721 ^B
1.6 i 16V	07.96-08.02	51-52/55		0 265 216 721 ^B
1.8 D, i	09.00-08.02	80		0 265 216 721 ^B
1.9 D	07.96-08.02	43-44/66		0 265 216 721 ^B
2.0 HDi	07.96-08.02	50/51/52		0 265 216 721 ^B
	12.99-08.02	66		0 265 216 721 ^B

Electric

1.1 i	01.98-08.02	24	TEI	0 273 004 112 ^H
1.4, i	07.96-08.02	44	TEI	0 273 004 112 ^H
1.6 i 16V	07.96-08.02	51-52/55	TEI	0 273 004 112 ^H
1.8 D, i	09.00-08.02	80	TEI	0 273 004 112 ^H
1.9 D	07.96-08.02	43-44/66	TEI	0 273 004 112 ^H
2.0 HDi	07.96-08.02	50/51/52	TEI	0 273 004 112 ^H
	12.99-08.02	66	TEI	0 273 004 112 ^H

Partner [M5]

Electric

1.1 i	ABO	09.02-04.08	28		0 204 123 373	23,81
	ABS	09.02-04.08	28		F 026 003 350	23,81
1.4 i	ABO	09.02-10.05	44		0 204 123 373	23,81
	ABS	09.02-10.05	44		F 026 003 350	23,81
1.6 HDi	ABO	09.02-04.08	55		0 204 123 373	23,81
	ABS	09.02-04.08	55		F 026 003 350	23,81
1.6 i 16V	ABO	09.02-04.08	66/80		0 204 123 373	23,81
	ABS	09.02-04.08	66/80		F 026 003 350	23,81
	MFD	09.02-04.08	66/80	LLE	0 204 123 644	23,8
				RLE	0 204 123 645	23,8
1.9 D	ABO	09.02-03.07	52		0 204 123 373	23,81
	ABS	09.02-03.07	52		F 026 003 350	23,81
2.0 HDi	ABO	09.02-07.06	66		0 204 123 373	23,81
	ABS	09.02-07.06	66		F 026 003 350	23,81
	MFD	09.02-07.06	66	LLE	0 204 123 644	23,8
				RLE	0 204 123 645	23,8

Electric









1.1 i		09.02-03.04	44	Org.-Nr. →9974	RLE	0 204 125 805
		09.02-10.05	44		LLE	0 204 125 804
		04.04-10.05	44	Org.-Nr. 9975 →	RLE	0 204 125 804
1.4 i		09.02-03.04	55	Org.-Nr. →9974	RLE	0 204 125 805
		09.02-04.08	55			0 204 125 804
					LLE	0 204 125 804

		S							
1.4 i		04.04-04.08	55	Org.-Nr. 9975→	RLE		0 204 125 804		
1.6 HDi		07.05-10.11	55/66				0 204 125 804		
1.6 i 16V		09.02-03.04	80	Org.-Nr. →9974	RLE		0 204 125 805		
		09.02-04.08	80		LLE		0 204 125 804		
		04.04-04.08	80	Org.-Nr. 9975→	RLE		0 204 125 804		
1.9 D		09.02-03.04	52	Org.-Nr. →9974	RLE		0 204 125 805		
		09.02-03.07	52		LLE		0 204 125 804		
		04.04-03.07	52	Org.-Nr. 9975→	RLE		0 204 125 804		
2.0 HDi		09.02-03.04	66	Org.-Nr. →9974	RLE		0 204 125 805		
		09.02-07.06	66		LLE		0 204 125 804		
		04.04-07.06	66	Org.-Nr. 9975→	RLE		0 204 125 804		
Electric		09.02-04.08	28		FEN,TW		0 986 482 030 ^A		
							0 986 482 031 ^A		
1.1 i		09.02-10.05	44		FEN,KOB		0 986 482 029 ^A		
					FEN,LWG		0 986 482 030 ^A		
1.4 i		09.02-04.08	55		FEN,KOB		0 986 482 029 ^A		
					FEN,LWG		0 986 482 030 ^A		
1.6 HDi		09.05-04.08	66		FEN		0 986 482 031 ^A		
1.6 i 16V		09.02-04.08	80		FEN,KOB		0 986 482 029 ^A		
					FEN,LWG		0 986 482 030 ^A		
1.9 D		09.02-03.07	52		FEN,KOB		0 986 482 029 ^A		
					FEN,LWG		0 986 482 030 ^A		
2.0 HDi		09.02-07.06	66		FEN,KOB		0 986 482 029 ^A		
					FEN,LWG		0 986 482 030 ^A		
Electric		09.02-11.04	28	Org.-Nr. →10220			0 265 216 721 ^B		
		12.04-12.07	28	Org.-Nr. 10221→11346			0 265 231 523 ^B		
1.1 i		09.02-11.04	44	Org.-Nr. →10220			0 265 216 721 ^B		
		12.04-10.05	44	Org.-Nr. 10221→			0 265 231 523 ^B		
1.4 i		09.02-11.04	55	Org.-Nr. →10220			0 265 216 721 ^B		
		12.04-12.07	55	Org.-Nr. 10221→11346			0 265 231 523 ^B		
1.6 HDi		07.05-12.07	55	Org.-Nr. →11346			0 265 231 523 ^B		
		09.05-12.07	66	Org.-Nr. →11346			0 265 231 523 ^B		
							0 265 234 061 ^T		
1.6 i 16V		09.02-11.04	80	Org.-Nr. →10220			0 265 216 721 ^B		
		12.04-12.07	80	Org.-Nr. 10221→11346			0 265 225 130 ^T		
							0 265 231 523 ^B		
							0 265 234 061 ^T		
1.9 D		09.02-11.04	52	Org.-Nr. →10220			0 265 216 721 ^B		
		12.04-03.07	52	Org.-Nr. 10221→			0 265 231 523 ^B		
2.0 HDi		09.02-11.04	66	Org.-Nr. →10220			0 265 216 721 ^B		
		12.04-07.06	66	Org.-Nr. 10221→			0 265 225 130 ^T		
							0 265 231 523 ^B		
							0 265 234 061 ^T		
1.6 HDi		09.02-12.07	66/80	Org.-Nr. →11346			0 265 005 290		
1.6 i 16V		01.08-04.08	66/80	Org.-Nr. 11347→			0 265 005 758		
2.0 HDi		09.02-07.06	66				0 265 005 290		
Ranch [M4]									
1.4 i	ABO	07.97-06.00	55	Org.-Nr. →8609					0 204 124 073 ⁶
		07.00-08.02	55	Org.-Nr. 8610→	JBH	F 026 003 190	23,8		
	ABS	07.97-06.00	55	Org.-Nr. →8609	JBH,LLE	F 026 003 192	23,8		
		07.00-08.02	55	Org.-Nr. 8610→	RLE	0 204 123 341	23,8		
		07.00-08.02	55	Org.-Nr. 8610→		F 026 003 350	23,81		
1.9 D	ABO	07.97-10.98	51						0 204 124 073 ⁶
		11.98-06.00	51	Org.-Nr. →8609	JBH	F 026 003 190	23,8		0 204 124 073 ⁶
					JBH	F 026 003 190	23,8		



		S							
PEUGEOT Ranch [M4]									
	1.9D	ABO	07.00-08.02	51	Org.-Nr. 8610→		0 204 123 373	23,81	
		ABS	07.97-10.98	51		JBH,LLE	F 026 003 192	23,8	
						RLE	0 204 123 341	23,8	
			11.98-06.00	51	Org.-Nr. →8609	JBH,LLE	F 026 003 192	23,8	
			07.00-08.02	51	Org.-Nr. 8610→	RLE	0 204 123 341	23,8	
						F 026 003 350	23,81		
	1.4 i		07.97-06.00	55	Org.-Nr. →8609		0 204 125 134		
			07.00-08.02	55	Org.-Nr. 8610→	BO	0 204 125 764		
	1.9D		07.97-10.98	51			0 204 125 134		
			11.98-06.00	51	Org.-Nr. →8609		0 204 125 134		
			07.00-08.02	51	Org.-Nr. 8610→	BO	0 204 125 764		
	1.4 i		07.97-08.02	55		FEN,KOB	0 986 482 029 ^A		
						FEN,LWG	0 986 482 030 ^A		
	1.9D		07.97-10.98	51		L01,LWG	0 986 482 031 ^A		
			07.97-08.02	51		FEN,KOB	0 986 482 029 ^A		
						FEN,LWG	0 986 482 030 ^A		
	1.4 i		07.97-08.02	55			0 265 216 721 ^B		
		1.9D	07.97-08.02	51			0 265 216 721 ^B		
	1.4 i		07.97-08.02	55		TEI	0 273 004 112 ^H		
		1.9D	07.97-08.02	51		TEI	0 273 004 112 ^H		
RCZ R [T75]									
	1.6 THP		09.13→	199			0 204 718 072		
			1.6 THP	09.13→	199			0 204 718 070	
	1.6 THP	09.13→	199				0 265 005 765		
RCZ [T75]									
	1.6 THP		01.10→	110/115/120			0 204 123 736	23,81	
							0 204 718 072		
		2.0 HDi	01.10→	120		Y61	0 204 123 736	23,81	
					302	0 204 718 072			
	1.6 THP		01.10→	110/115/120			0 204 125 902		
							0 204 718 070		
		2.0 HDi	01.10→	120		Y61	0 204 718 070		
					302	0 204 125 902			
	2.0 HDi	01.10→	120				0 986 486 616	19	
	1.6 THP		01.10→	110/115/120/147			0 265 005 765		
		2.0 HDi	01.10→	120			0 265 005 765		
106 [S1]									
	1.0		09.91-04.96	33/37					0 204 124 068 ⁶
		1.0 i				BSY			0 204 124 069 ⁶



		S							
1.0		09.91-04.96	33/37			JBH	F 026 003 103	19	
1.0i							ATE F 026 003 243	20,6	
							BSY F 026 003 180	20,6	
1.0i	ABS	07.92-04.96	33/37						0 204 124 064 ⁶
1.1		09.91-04.96	40-44						0 204 124 068 ⁶
1.1i							BSY		0 204 124 069 ⁶
						JBH	F 026 003 103	19	
							ATE F 026 003 243	20,6	
							BSY F 026 003 180	20,6	
1.1i	ABS	08.92-04.96	40-44						0 204 124 064 ⁶
1.3i		10.93-04.96	72-74				BSY		0 204 124 069 ⁶
						JBH	BSY F 026 003 180	20,6	
	ABS	10.93-04.96	72-74						0 204 124 064 ⁶
1.4		09.91-04.96	37/44/						0 204 124 068 ⁶
1.4D			55-56			JBH	F 026 003 103	19	
1.4i	ABS	09.91-04.96	37/44/55-56/69/72						0 204 124 064 ⁶
1.4i		09.91-04.96	69/72				BSY		0 204 124 069 ⁶
						JBH	BSY F 026 003 180	20,6	
1.5D		07.94-04.96	40-42						0 204 124 068 ⁶
						JBH	F 026 003 103	19	
	ABS	07.94-04.96	40-42						0 204 124 064 ⁶
1.6i		06.93-04.96	65-66						0 204 124 068 ⁶
			76-77				BSY		0 204 124 069 ⁶
						JBH	BSY F 026 003 180	20,6	
	ABS	06.93-04.96	65-66/76-77						0 204 124 064 ⁶
 1.0		09.91-04.96	33/37			BD7,LLE	0 204 125 102		
1.0i						BD7,RLE	0 204 125 094		
						BD8,LLE	0 204 125 104		
						BD8,RLE	0 204 125 216		
1.1		09.91-04.96	40-44			BD7,LLE	0 204 125 102		
1.1i						BD7,RLE	0 204 125 094		
						BD8,LLE	0 204 125 104		
						BD8,RLE	0 204 125 216		
1.3i		10.93-04.96	72-74			BD8,LLE	0 204 125 104		
						BD8,RLE	0 204 125 216		
1.4		07.92-04.96	44			BD7,LLE	0 204 125 102		
						BD8,LLE	0 204 125 104		
1.4		09.91-04.96	55			BD7,LLE	0 204 125 102		
1.4i						BD7,RLE	0 204 125 094		
						BD8,LLE	0 204 125 104		
						BD8,RLE	0 204 125 216		
1.4D		09.92-04.96	37			BD7,LLE	0 204 125 102		
						BD7,RLE	0 204 125 094		
						BD8,LLE	0 204 125 104		
						BD8,RLE	0 204 125 216		
1.4i		09.91-04.96	69/72			BD8,LLE	0 204 125 104		
						BD8,RLE	0 204 125 216		
		12.92-04.96	55-56			BD7,LLE	0 204 125 102		
						BD8,LLE	0 204 125 104		
						BD8,RLE	0 204 125 216		
1.5D		07.94-04.96	40-42			BD7,LLE	0 204 125 102		
						BD7,RLE	0 204 125 094		
						BD8,LLE	0 204 125 104		
						BD8,RLE	0 204 125 216		
1.6i		06.93-04.96	65-66			BD7,LLE	0 204 125 102		
						BD7,RLE	0 204 125 094		
						BD8,LLE	0 204 125 104		
						BD8,RLE	0 204 125 216		
			76-77			BD8,LLE	0 204 125 104		
						BD8,RLE	0 204 125 216		





◀ PEUGEOT 106 [S1]

	1.0 i	ABS	07.92-04.96	33/37		0 204 131 065	
	1.1 i	ABS	08.92-04.96	40-44		0 204 131 065	
	1.3 i	ABS	10.93-04.96	72-74		0 204 131 065	
	1.4, D, i	ABS	09.91-04.96	37/44/55-56/69/72		0 204 131 065	
	1.5 D	ABS	07.94-04.96	40-42		0 204 131 065	
	1.6 i	ABS	06.93-04.96	65-66/76-77		0 204 131 065	

106 [S2]



	Electric	ABO	07.95-05.05	11-20	JBH	F 026 003 342	20,6	
	1.0 i		05.96-05.05	33/37	BSY			0 204 124 143 ⁶
		ABO	05.96-05.05	33/37	JBH	F 026 003 207	19	
		ABS	05.96-05.05	33/37	JBH	F 026 003 342	20,6	
		ABS	05.96-05.05	33/37	JBH	F 026 003 208	20,6	
	1.1 i		05.96-05.05	40-44	BSY			0 204 124 143 ⁶
		ABO	05.96-05.05	40	JBH	F 026 003 207	19	
				40-44	JBH	F 026 003 342	20,6	
				44	JBH	F 026 003 342	20,6	
			03.00-05.05	44	JBH	F 026 003 342	20,6	
		ABS	05.96-05.05	40-44	JBH	F 026 003 208	20,6	
	1.4	ABO	05.96-05.05	55				0 204 124 143 ⁶
					JBH	F 026 003 207	19	
		ABS	05.96-05.05	55	JBH	F 026 003 208	20,6	
	1.4 i		05.96-05.05	55	BSY			0 204 124 143 ⁶
					JBH	F 026 003 207	19	
		ABS	05.96-05.05	55	JBH	F 026 003 208	20,6	
	1.5 D		05.96-05.05	40-42	BSY			0 204 124 143 ⁶
					JBH	F 026 003 207	19	
		ABS	05.96-05.05	40-42	JBH	F 026 003 208	20,6	
	1.6 i	ABO	05.96-05.05	65-66	JBH	F 026 003 342	20,6	
				74-77	JBH	F 026 003 342	20,6	
					BSY	F 026 003 342	20,6	
		ABS	05.96-05.05	65-66/74-77	JBH	F 026 003 208	20,6	
	1.6 i 16S	ABO	05.96-05.05	87-88	JBH	F 026 003 342	20,6	

	Electric		05.96-05.05	11-20	BD8,LLE	0 204 125 484	
	1.0 i		05.96-05.05	33/37	BD7,LLE	0 204 125 485	
					BD7,RLE	0 204 125 094	
					BD8,LLE	0 204 125 484	
					BD8,RLE	0 204 125 216	
	1.1 i		05.96-05.05	40-44	BD7,LLE	0 204 125 485	
					BD7,RLE	0 204 125 094	
					BD8,LLE	0 204 125 484	
					BD8,RLE	0 204 125 216	
	1.4 i		05.96-05.05	55	BD7,LLE	0 204 125 485	
					BD7,RLE	0 204 125 094	
					BD8,LLE	0 204 125 484	
					BD8,RLE	0 204 125 216	
	1.5 D		05.96-05.05	40-42	BD7,LLE	0 204 125 485	
					BD7,RLE	0 204 125 094	
					BD8,LLE	0 204 125 484	
					BD8,RLE	0 204 125 216	
	1.6 i		05.96-05.05	65-66/74-77/	BD8,LLE	0 204 125 484	
	1.6 i 16S			87-88	BD8,RLE	0 204 125 216	

	1.0 i	ABS	05.96-05.05	33/37	HTB	0 204 131 093	
	1.1 i	ABS	05.96-05.05	40-44	HTB	0 204 131 093	
	1.4, i	ABS	05.96-05.05	55	HTB	0 204 131 093	
	1.5 D	ABS	05.96-05.05	40-42	HTB	0 204 131 093	
	1.6 i	ABS	05.96-05.05	65-66	HTB	0 204 131 093	
	1.6 i, i 16S		05.96-05.05	74-77/87-88	SBR	0 204 131 092	



107 [B0]

	1.0	MFD 06.05→	50		LLE	0 204 123 787	20,64
					RLE	0 204 123 786	20,64
		OFD 06.05→	50		LLE	0 204 123 667	20,6
					RLE	0 204 123 666	20,6
	1.4 HDi	MFD 06.05→	40		LLE	0 204 123 787	20,64
					RLE	0 204 123 786	20,64
		OFD 06.05→	40		LLE	0 204 123 667	20,6
					RLE	0 204 123 666	20,6
	1.0	06.05-08.10	50		LLE	0 204 125 831	
					RLE	0 204 125 830	
		09.10-09.10	50	Org.-Nr. →12333	LLE	0 204 125 831	
					RLE	0 204 125 830	
		MFD 10.10→	50	Org.-Nr. 12334→	LLE	0 204 125 831	
					RLE	0 204 125 830	
		OFD 10.10→	50	Org.-Nr. 12334→	LLE	0 204 744 467	
					RLE	0 204 744 465	
	1.4 HDi	06.05-09.10	40	Org.-Nr. →12333	LLE	0 204 125 831	
					RLE	0 204 125 830	
		MFD 10.10→	40	Org.-Nr. 12334→	LLE	0 204 125 831	
					RLE	0 204 125 830	
		OFD 10.10→	40	Org.-Nr. 12334→	LLE	0 204 744 467	
					RLE	0 204 744 465	
	1.0	06.05-08.10	50			0 265 231 580^B	
		09.10-02.12	50	Org.-Nr. →12872		0 265 231 580^B	
	1.4 HDi	06.05-02.12	40	Org.-Nr. →12872		0 265 231 580^B	

108 [B3]

	1.0	MFD 02.14→	50		LLE	0 204 822 666	20,64
					RLE	0 204 822 668	20,64
		OFD 02.14→	50		LLE	0 204 822 665	20,64
					RLE	0 204 822 667	20,64
	1.2 VTi	MFD 02.14→	60		LLE	0 204 822 666	20,64
					RLE	0 204 822 668	20,64
		OFD 02.14→	60		LLE	0 204 822 665	20,64
					RLE	0 204 822 667	20,64
	1.0	MFD 02.14→	50		LLE,SSJ	0 204 822 655	
					LLE,SSJ	0 204 822 653	
					RLE,SSJ	0 204 822 661	
					RLE,SSJ	0 204 822 659	
		OFD 02.14→	50		LLE	0 204 822 651	
					RLE	0 204 822 657	
	1.2 VTi	MFD 02.14→	60		LLE,SSJ	0 204 822 655	
					LLE,SSJ	0 204 822 653	
					RLE,SSJ	0 204 822 661	
					RLE,SSJ	0 204 822 659	
		OFD 02.14→	60		LLE	0 204 822 651	
					RLE	0 204 822 657	

205

	1.0	10.87-09.98	33-37		AS4		0 204 124 068⁶
	1.0i				AS4,JBH	F 026 003 103	19



		S							
◀ PEUGEOT 205									
1.0		ABO	10.87-09.98	33-37		AS4	BRB, BSY		0 204 124 069 ⁶
1.0 i						AS4,JBH	ATE BRB, BSY	F 026 003 243 F 026 003 180	20,6 20,6
		ABS	10.90-09.98	33-37		RLE		0 204 123 172	20,6
1.1 i			07.89-09.98	44		AS4			0 204 124 068 ⁶
						AS4,JBH		F 026 003 103	19
		ABO	07.89-09.98	44		AS4	BRB, BSY		0 204 124 069 ⁶
						AS4,JBH	ATE BRB, BSY	F 026 003 243 F 026 003 180	20,6 20,6
		ABS	10.90-09.98	44		RLE		0 204 123 172	20,6
1.4			10.87-09.98	44-50/		AS4			0 204 124 068 ⁶
1.4 i				55-58		AS4,JBH		F 026 003 103	19
		ABO	10.87-09.98	44-50/ 55-58		AS4	BRB, BSY		0 204 124 069 ⁶
						AS4,JBH	ATE BRB, BSY	F 026 003 243 F 026 003 180	20,6 20,6
		ABS	10.90-09.98	44/55-58		RLE		0 204 123 172	20,6
1.6			11.90-09.98	53-58/65/ 83		AS4			0 204 124 068 ⁶
1.6 i						AS4,JBH		F 026 003 103	19
		ABO	11.90-09.98	53-58/65/ 83		AS4	BRB, BSY		0 204 124 069 ⁶
						AS4,JBH	ATE BRB, BSY	F 026 003 243 F 026 003 180	20,6 20,6
		ABS	11.90-09.98	53-58/65/83		RLE		0 204 123 172	20,6
1.8 D Turbo		ABS	10.90-09.98	58		RLE		0 204 123 172	20,6
1.8 D			07.87-12.98	44/58		AS4			0 204 124 068 ⁶
1.8 D Turbo						AS4,JBH		F 026 003 103	19
		ABO	07.87-12.98	44/58		AS4	BRB, BSY		0 204 124 069 ⁶
						AS4,JBH	ATE BRB, BSY	F 026 003 243 F 026 003 180	20,6 20,6
1.9 D			10.87-09.98	47/75/88/ 90-94		AS4			0 204 124 068 ⁶
1.9 i						AS4,JBH		F 026 003 103	19
		ABO	10.87-09.98	47/75/88/ 90-94		AS4	BRB, BSY		0 204 124 069 ⁶
						AS4,JBH	ATE BRB, BSY	F 026 003 243 F 026 003 180	20,6 20,6
		ABS	10.90-09.98	47/75/88/90-94		RLE		0 204 123 172	20,6
1.0		ABO	10.87-09.98	33-37				0 204 125 058	
1.0 i		ABS	10.87-09.98	33-37				0 204 125 134	
1.1 i		ABO	07.89-09.98	44				0 204 125 058	
		ABS	07.89-09.98	44				0 204 125 134	
1.4		ABO	10.87-12.94	44-50/55				0 204 125 058	
1.4, i		ABS	10.87-09.98	44-50/55-58				0 204 125 134	
1.6		ABO	11.90-09.98	53-58				0 204 125 058	
1.6, i		ABS	11.90-09.98	53-58/65/83				0 204 125 134	
1.8 D		ABO	07.87-12.98	44/58				0 204 125 058	
1.8 D Turbo		ABS	07.87-12.98	44/58				0 204 125 134	
1.9 D		ABO	10.87-09.98	47				0 204 125 058	
1.9 D, i		ABS	10.87-09.98	47/75/88/90-94				0 204 125 134	
1.9 i			10.90-09.98	75/88/90-94			BSY	0 204 125 079	



	1.0		10.87-09.98	33-37		LWG		0 204 131 086 ^A	
	1.0i	ABS	10.87-09.98	33-37				0 204 131 052 ^A	
	1.1i		07.89-09.98	44		LWG		0 204 131 086 ^A	
		ABS	07.89-09.98	44				0 204 131 052 ^A	
	1.4		10.87-09.98	44/55-58		LWG		0 204 131 086 ^A	
		ABS	10.87-09.98	44-50/55-58				0 204 131 052 ^A	
	1.6		11.90-09.98	53-58		LWG		0 204 131 086 ^A	
		ABS	11.90-09.98	53-58/65				0 204 131 052 ^A	
	1.6i		11.90-09.98	65/83				0 986 482 009	
							LWG		0 204 131 086 ^A
	1.8D	ABS	07.87-12.98	44				0 204 131 052 ^A	
			01.90-09.98	58		LWG		0 204 131 086 ^A	
	1.8D Turbo					LWG		0 204 131 064 ^A	
						LWG		0 204 131 086 ^A	
	1.9D		10.87-09.98	47		LWG		0 204 131 086 ^A	
		ABS	10.87-09.98	47				0 204 131 052 ^A	
	1.9i		10.87-10.94	75				0 986 482 009	
							LWG		0 204 131 086 ^A
	1.9i		10.87-09.98	88/90-94		LWG		0 204 131 086 ^A	
								Fg.-Nr. →S 1811241	0 204 131 049
							Fg.-Nr. →S 1831920	0 204 131 049	
							Fg.-Nr. S 1811241→	0 204 131 048	
							Fg.-Nr. S 1831921→	0 204 131 048	

205 Pickup

	1.8D		05.85-09.98	44		AS4			0 204 124 068 ⁶
						AS4, JBH	F 026 003 103	19	
	1.8D	ABO	05.85-09.98	44		AS4	BRB, BSY		0 204 124 069 ⁶
						AS4, JBH	ATE	F 026 003 243	20,6
							BRB, BSY	F 026 003 180	20,6
	1.8D	ABS	10.90-09.98	44		RLE		0 204 123 172	20,6
									0 204 124 064 ⁶

	1.8D	ABO	05.85-09.98	44				0 204 125 058	
		ABS	05.85-09.98	44				0 204 125 134	

	1.8D	ABS	05.85-09.98	44				0 204 131 052 ^A	
--	------	-----	-------------	----	--	--	--	----------------------------	--

206

	1.0i 16V	ABO	06.01-12.05	52		JBH	ATE	0 986 480 939	20,64
							BSY	F 026 003 419	20,64
	1.4i	ABO	02.04-12.05	55		JBH	ATE	0 986 480 939	20,64
							BSY	F 026 003 419	20,64
	1.6i	ABS	02.04-12.05	55		JBH	ATE	0 986 480 854	22,2
		ABO	10.99-10.03	65		JBH	ATE	0 986 480 939	20,64
							BSY	F 026 003 419	20,64
		ABS	10.99-10.03	65		JBH	ATE	0 986 480 854	22,2

	1.0i 16V	ABO	06.01-12.05	52			BSY	0 204 125 605	
	1.4i	ABO	02.04-12.05	55			BSY	0 204 125 605	
	1.6i	ABO	10.99-10.03	65			BSY	0 204 125 605	

	1.4i	ABO	02.04-12.05	55				0 204 031 110 ^A	
		ABS	02.04-12.05	55				0 204 031 109 ^A	
	1.6i	ABO	10.99-10.03	65				0 204 031 110 ^A	
		ABS	10.99-10.03	65				0 204 031 109 ^A	



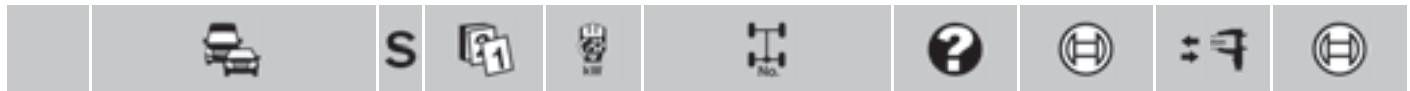

◀ PEUGEOT

206 CC [T1]



	1.6 HDi	OFD	06.05-03.07	80	JBH, KZO	0 986 480 854	22,2
	1.6 i 16V	ABO	09.00-03.07	80	GS, JBH	0 986 480 854	22,2
		OFD	09.00-03.07	80	GS, JBH	F 026 003 502	22,2
	2.0 i S16		09.00-03.07	100	JBH ATE	0 986 480 854	22,2

	1.6 i 16V	ABO	09.00-03.07	80		0 204 031 181	
--	-----------	-----	-------------	----	--	---------------	--

206 Sedan [T1]



	1.4	ABO	02.06-03.09	55	GS, JBH ATE	0 986 480 939	20,64
					BO	F 026 003 419	20,64
		ABS	02.06-03.09	55	GS, JBH ATE	0 986 480 854	22,2
	1.4 HDi 16V	ABO	09.08-12.10	50	JBH, TW	F 026 003 419	20,64

						0 986 480 939	20,64
					JBH	0 986 480 854	22,2

	1.4		02.06-03.09	55	GS BO	0 204 125 605	
--	-----	--	-------------	----	-------	---------------	--

	1.4	ABO	02.06-03.09	55		0 204 031 110 ^A	
		ABS	02.06-03.09	55		0 204 031 109 ^A	

206 SW



	1.4 i	ABO	03.05-12.05	55	JBH ATE	0 986 480 939	20,64
					BSY	F 026 003 419	20,64
	1.6 i 16V	ABO	03.04-04.05	79	JBH ATE	F 026 003 502	22,2

		ABS	03.04-04.05	79	JBH ATE	0 986 480 854	22,2
--	--	-----	-------------	----	---------	---------------	------

	1.4 i	ABO	03.05-12.05	55		BSY	0 204 125 605
--	-------	-----	-------------	----	--	-----	---------------

	1.4 i	ABO	03.05-12.05	55		0 204 031 110 ^A	
		ABS	03.05-12.05	55		0 204 031 109 ^A	

	1.6 i 16V	ABO	03.04-04.05	79		0 204 031 109 ^A	
--	-----------	-----	-------------	----	--	----------------------------	--

206 SW [T1]















	1.1 i		03.02-10.05	44	JBH	0 986 480 854	22,2
	1.4 HDi		03.02-12.06	50	JBH	0 986 480 854	22,2
	1.4 i		03.02-12.06	55	GS, JBH	0 986 480 854	22,2
	1.4 i 16V	ABO	10.03-05.06	65	JBH	F 026 003 502	22,2
		ABS	10.03-05.06	65	JBH	0 986 480 854	22,2
	1.6 HDi	OFD	05.04-12.06	80	JBH, KZO	0 986 480 854	22,2
	1.6 i 16V		03.02-12.06	80	GS, JBH	0 986 480 854	22,2
	2.0 HDi, i S16		03.02-10.05	66/100	JBH	0 986 480 854	22,2

206 [T1]



	1.1 i	ABO	06.98-10.05	40/44	JBH ATE	0 986 480 939	20,64
					BO	F 026 003 419	20,64
		ABS	06.98-10.05	40/44	JBH ATE	0 986 480 854	22,2

		S													
1.4		ABO	03.00-02.09	55		JBH	ATE	0 986 480 939	20,64						
							BO	F 026 003 419	20,64						
1.4 HDi		ABO	09.01-02.09	50		JBH	ATE	0 986 480 939	20,64						
							BO	F 026 003 419	20,64						
1.4 i		ABO	06.98-02.09	55		GS,JBH	ATE	0 986 480 939	20,64						
							BO	F 026 003 419	20,64						
1.4 i 16V		ABO	10.03-05.06	65		JBH		F 026 003 502	22,2						
							ABS	0 986 480 854	22,2						
1.6 HDi		OFD	05.04-03.07	80		JBH,KZO		0 986 480 854	22,2						
1.6 i		ABO	06.98-08.07	66		GS,JBH	ATE	0 986 480 939	20,64						
							BO	F 026 003 419	20,64						
1.6 i 16V		ABO	03.00-08.07	80		GS,JBH		0 986 480 854	22,2						
							OFD	F 026 003 502	22,2						
1.9 D		ABO	06.98-03.06	51/52		JBH,KZO	BO	F 026 003 419	20,64						
			06.98-03.06	51/52			ATE	0 986 480 939	20,64						
			06.98-03.06	51/52			ATE	0 986 480 854	22,2						
2.0 HDi		ABO	04.99-10.05	66		JBH,KZO	ATE	0 986 480 939	20,64						
							ABS	0 986 480 854	22,2						
2.0 iS16			01.99-11.04	99/100		JBH	ATE	0 986 480 854	22,2						
		ABO	06.98-10.05	40/44			BO	0 204 125 604							
							1.4	ABO	03.00-02.09	55		BO	0 204 125 821		
							1.4 HDi	ABO	09.01-02.09	50		BSY	0 204 125 605		
							1.4 i		06.98-02.09	55		GS	BO	0 204 125 605	
							1.6 i		06.98-08.07	66		GS	BO	0 204 125 605	
1.9 D	ABO	06.98-03.06	51/52		KZO	BSY	0 204 125 605								
		ABO	06.98-10.05	40/44				0 204 031 110 ^A							
							ABS	06.98-10.05	40/44		0 204 031 109 ^A				
							1.4 HDi, i	ABO	06.98-02.09	50/55			0 204 031 110 ^A		
							1.4 i	ABS	06.98-02.09	55			0 204 031 109 ^A		
							1.6 i	ABO	06.98-08.07	66			0 204 031 110 ^A		
							ABS	06.98-08.07	66			0 204 031 109 ^A			
							1.6 i 16V	ABO	03.00-08.07	80			0 204 031 109 ^A		
							1.9 D	ABO	06.98-03.06	51/52			0 204 031 110 ^A		
							ABS	06.98-03.06	51/52			0 204 031 109 ^A			
							2.0 HDi		04.99-10.05	66			0 204 031 109 ^A		
206+ [T3E]															
		ABO	03.09→	44		JBH	ATE	0 986 480 939	20,64						
							BO	F 026 003 419	20,64						
							ABS	03.09→	44		JBH	0 986 480 854	22,2		
							1.4	ABO	03.09→	50/54/55		JBH	ATE	0 986 480 939	20,64
							1.4 HDi					BO	F 026 003 419	20,64	
	OFD	03.09→	50/54/55		JBH	0 986 480 854	22,2								
		ABO	03.09→	44			BO	0 204 125 821							
							1.4, HDi	ABO	03.09→	50/54/55		BO	0 204 125 821		
			03.09→	44				0 204 031 110 ^A							
							1.4, HDi		03.09→	50/54/55		0 204 031 110 ^A			
							1.6		02.11→	80		0 204 031 110 ^A			



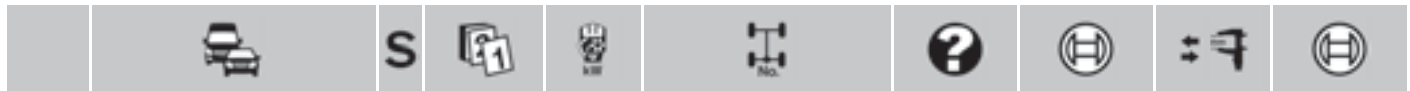

◀ PEUGEOT

208



	1.0 VTi	MFD 01.12→	50			0 204 123 811	22,2
		OFD 01.12→	50			0 204 123 809	22,2
	1.2 VTi	01.14→	60			0 204 123 811	22,2
		MFD 01.12→	60			0 204 123 811	22,2
		OFD 01.12→	60			0 204 123 809	22,2
	1.0 VTi	MFD 01.12-07.13	50	Org.-Nr. →13397		0 204 720 419	
		OFD 01.12-05.13	50	Org.-Nr. →13341		0 204 720 418	
	1.2 VTi	MFD 01.12-07.13	60	Org.-Nr. →13397		0 204 720 419	
		OFD 01.12-05.13	60	Org.-Nr. →13341		0 204 720 418	

301 [M3]



	1.2 VTi	MFD 09.12→	52			0 204 123 811	22,2
		OFD 09.12-05.13	52	Org.-Nr. →13341		0 204 123 809	22,2
	1.6 HDi	OFD 09.12-05.13	68	Org.-Nr. →13341		0 204 123 809	22,2
	1.6 VTi	MFD 09.12→	85			0 204 123 811	22,2
		OFD 09.12-05.13	85	Org.-Nr. →13341		0 204 123 809	22,2
		06.13→	85	Org.-Nr. 13342→	AG	0 204 123 809	22,2
	1.2 VTi	MFD 09.12→	52			0 204 720 419	
		OFD 09.12→	52		AG	0 204 720 418	
	1.6 HDi	MFD 09.12→	68/85			0 204 720 419	
	1.6 VTi	OFD 09.12→	68/85		AG	0 204 720 418	

306



	1.8 i	ABO 03.97-03.07	74		JBH	ATE 0 986 480 939	20,64
						BSY F 026 003 349	20,64
		ABS 03.97-03.07	74		JBH	ATE 0 986 480 854	22,2
						BSY F 026 003 501	
	1.8 i	03.97-03.07	74			BO 0 204 125 514	
	1.8 i	03.97-03.07	74			0 204 131 270 ^A	
	1.8 i	03.97-03.07	74		BKR,STB	0 265 216 723 ^B	
		05.97-03.07	74		BKR,STB	0 265 216 483 ^B	

306 Break [N5]



	1.4	ABO 05.97-03.02	55		JBH	ATE F 026 003 502	22,2
		ABS 05.97-03.02	55		LLE	BSY F 026 003 350	23,81
	1.6 i	ABO 05.97-03.02	65-66/74		JBH	ATE F 026 003 502	22,2
		ABS 05.97-03.02	65-66/74		LLE	BSY F 026 003 350	23,81
	1.8 i	ABO 05.97-03.02	74-76/81		LLE	BSY 0 204 123 373	23,81
	1.8 i 16V	ABS 05.97-03.02	74-76/81		LLE	BSY F 026 003 350	23,81
	1.9 D	ABO 05.97-03.02	50/51/52		JBH,LLE	ATE F 026 003 502	22,2
	1.9 D Turbo	ABO 05.97-03.02	55/66		LLE	BSY 0 204 123 373	23,81
	1.9 D, D Turbo	ABS 05.97-03.02	50/51/52/55/66		LLE	BSY F 026 003 350	23,81
	2.0 HDi	ABO 05.97-03.02	66/97-99		LLE	BSY 0 204 123 373	23,81
	2.0 i 16V	ABS 05.97-03.02	66/97-99		LLE	BSY F 026 003 350	23,81



	1.4	ABS	05.97-03.02	55		LLE	BSY	0 204 125 514	
	1.4, i	ABS	05.97-03.02	55		RLE	BSY	0 204 125 134	
	1.4 i			10.00-03.02	55		LLE	BO	0 204 125 514
			ABO	10.00-03.02	55		RLE	BSY	0 204 125 514
			ABS	05.97-03.02	55		LLE	BSY	0 204 125 514
	1.6 i			10.00-03.02	74		LLE	BO	0 204 125 514
			ABO	10.00-03.02	74		RLE	BSY	0 204 125 514
			ABS	05.97-10.00	65-66		LLE	BSY	0 204 125 514
				10.00-03.02	74		RLE	BSY	0 204 125 134
	1.8 i		05.97-03.02	74-76/81		BD9,RLE		0 204 125 134	
	1.8 i 16V	ABS	05.97-03.02	74-76/81		LLE	BSY	0 204 125 514	
	1.9 D	ABS	05.97-03.02	50/51/52		LLE	BSY	0 204 125 514	
						RLE	BSY	0 204 125 134	
	1.9 D Turbo		05.97-03.02	55/66		BD9,RLE		0 204 125 134	
		ABS	05.97-03.02	55/66		LLE	BSY	0 204 125 514	
2.0 HDi		06.99-03.02	66		BD9,LLE		0 204 125 514		
					BD9,RLE		0 204 125 134		
2.0 i 16V		05.97-03.02	97-99		BD9,RLE		0 204 125 134		
	ABS	05.97-03.02	97-99		LLE	BSY	0 204 125 514		

	1.4		06.98-03.02	55	Org.-Nr. 7847→			0 204 131 270^A	
	1.4	ABO	05.97-05.98	55	Org.-Nr. →7846	VFG		0 204 131 269^A	
	1.4 i	ABS	05.97-05.98	55	Org.-Nr. →7846	NOR		0 204 131 268^A	
	1.4 i			06.98-03.02	55	Org.-Nr. 7847→			0 204 131 270^A
				10.00-03.02	55				0 204 131 270^A
	1.6 i			06.98-10.00	65-66	Org.-Nr. 7847→			0 204 131 270^A
				10.00-03.02	74				0 204 131 270^A
			ABO	05.97-05.98	65-66	Org.-Nr. →7846	VFG		0 204 131 269^A
		ABS	05.97-05.98	65-66	Org.-Nr. →7846	NOR		0 204 131 268^A	
	1.8 i		05.97-05.98	74-76	Org.-Nr. →7846	NOR		0 204 131 268^A	
				06.98-03.02	74-76	Org.-Nr. 7847→	VFG		0 204 131 269^A
								0 204 131 270^A	
	1.8 i 16V		05.97-03.02	81				0 204 131 271^A	
	1.9 D		06.98-03.02	50	Org.-Nr. 7847→			0 204 131 270^A	
				51	Org.-Nr. 7847→			0 204 131 270^A	
				09.98-03.02	51				0 204 131 270^A
				09.99-03.02	52				0 204 131 270^A
			ABO	05.97-05.98	50/51	Org.-Nr. →7846	VFG		0 204 131 269^A
		ABS	05.97-05.98	50/51	Org.-Nr. →7846	NOR		0 204 131 268^A	
	1.9 D Turbo		05.97-05.98	66	Org.-Nr. →7846			0 204 131 268^A	
			06.98-03.02	55	Org.-Nr. 7847→			0 204 131 270^A	
				66	Org.-Nr. 7847→			0 204 131 270^A	
	2.0 HDi		06.99-03.02	66				0 204 131 270^A	
	2.0 i 16V		05.97-03.02	97-99				0 204 131 271^A	

	1.4		05.97-03.02	55		BKR,STB		0 265 216 554^B	
	1.4 i					BKR,STB		0 265 216 723^B	
	1.6 i		05.97-03.02	65-66/74			BKR,STB		0 265 216 554^B
							BKR,STB		0 265 216 723^B
	1.8 i		05.97-03.02	74-76			BKR,STB		0 265 216 554^B
							BKR,STB		0 265 216 723^B
	1.8 i 16V		05.97-06.00	81	Org.-Nr. →8609	4SB,BKR		0 265 216 699^B	
			05.97-03.02	81		4SB,BKR		0 265 216 484^B	
			07.00-03.02	81	Org.-Nr. 8610→	4SB,BKR		0 265 216 723^B	
	1.9 D		05.97-03.02	50/51/52/		BKR,STB		0 265 216 554^B	
	1.9 D Turbo			55/66		BKR,STB		0 265 216 723^B	
	2.0 HDi		05.97-06.00	66/97-99	Org.-Nr. →8609	4SB,BKR		0 265 216 699^B	
	2.0 i 16V		05.97-03.02	66/97-99		4SB,BKR		0 265 216 484^B	
			07.00-03.02	66/97-99	Org.-Nr. 8610→	4SB,BKR		0 265 216 723^B	



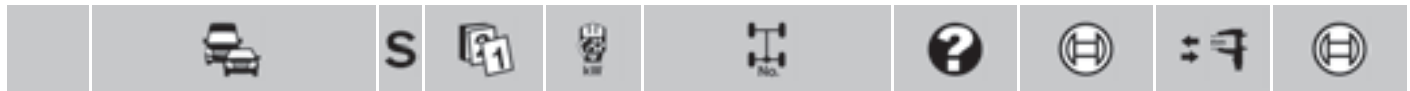

◀ PEUGEOT

306 Cabriolet [N3]



	1.6 i	ABO	01.93-04.97	65-66	Fg.-Nr. →31153000	JBH	F 026	003 170	20,6	
					Fg.-Nr. S31153001→	JBH,LLE	ATE	0986	480 835	20,6
					Fg.-Nr. 31153001→	JBH	BSY	F 026	003 342	20,6
	ABS	01.93-04.97	65-66	Fg.-Nr. →30209024		BSY	0 204	123 172	20,6	0 204 124 064⁶
				Fg.-Nr. 30209025→31153000		BSY				0 204 124 063⁶
					JBH	BSY	F 026	003 174	22,2	
1.8 i	ABO	01.93-04.97	74-76	Fg.-Nr. →31153000	JBH	F 026	003 170	20,6		
				Fg.-Nr. S31153001→	JBH,LLE	ATE	0986	480 835	20,6	
				Fg.-Nr. 31153001→	JBH	BSY	F 026	003 342	20,6	
	ABS	01.93-04.97	74-76	Fg.-Nr. →30209024		BSY	0 204	123 172	20,6	0 204 124 064⁶
				Fg.-Nr. 30209025→31153000		BSY			0 204 124 063⁶	
					JBH	BSY	F 026	003 174	22,2	
2.0 i		08.93-04.97	89-90			BSY			0 204 124 063⁶	
					JBH	BSY	F 026	003 174	22,2	

	1.6 i	ABO	01.93-04.97	65-66		BD8	BSY	0 204	125 079
					Fg.-Nr. →31153000	TD8	ATE	0986	485 105
	ABS	01.93-04.97	65-66	Fg.-Nr. →31153000		BSY	0 204	125 134	
1.8 i	ABS	01.93-04.97	74-76	Fg.-Nr. →31153000		BSY	0 204	125 134	
2.0 i		08.93-04.97	89-90			BSY	0 204	125 134	

	1.6 i	ABS	01.93-04.97	65-66				0 204	131 048
	1.8 i	ABS	01.93-04.97	74-76				0 204	131 067^A
	2.0 i	ABO	08.93-04.97	89-90				0 204	131 069
		ABS	08.93-04.97	89-90				0 204	131 067^A

	1.6 i		01.93-09.95	65-66		BO	0 265	208 321^B
						BO	0 265	216 340^B
	1.8 i		01.93-09.95	74-76		BO	0 265	208 321^B
						BO	0 265	216 340^B
	2.0 i		08.93-09.95	89-90		BO	0 265	208 321^B
						BO	0 265	216 340^B

	1.6 i		01.93-09.95	65-66		TEI	BO	2 267	000 735^H
						HTB	BO	1 267	000 828^H
	1.8 i		01.93-09.95	74-76		TEI	BO	2 267	000 735^H
						HTB	BO	1 267	000 828^H
	2.0 i		08.93-09.95	89-90		TEI	BO	2 267	000 735^H
						SBR,TEI		1 267	000 821^H

306 Cabriolet [N5]



	1.6 i	ABO	05.97-02.98	65-66	Org.-Nr. →7737	JBH	ATE	0986	480 835	20,6	
							BSY	F 026	003 342	20,6	
		ABS	05.97-05.00	65-66	Org.-Nr. →8575	JBH,LLE	ATE	0986	480 854	22,2	
							BSY	F 026	003 501		
				06.00-10.03	65-66	Org.-Nr. 8576→	LLE	BSY	F 026	003 350	23,81
				10.00-10.03	74		LLE	BSY	F 026	003 350	23,81
	1.8 i	ABO	05.97-10.03	74-76		JBH	BSY	F 026	003 342	20,6	
	1.8 i	ABS	05.97-05.00	74-76/81	Org.-Nr. →8575	JBH,LLE	ATE	0986	480 854	22,2	
	1.8 i 16V			06.00-10.03	74-76/81	Org.-Nr. 8576→	LLE	BSY	F 026	003 501	23,81
	1.8 i 16V	ABO	05.97-02.98	81	Org.-Nr. →7744	JBH	BSY	F 026	003 174	22,2	
	2.0 i 16V	ABO	05.97-02.98	97-99	Org.-Nr. →7744	JBH	BSY	F 026	003 174	22,2	
						ABS	05.97-05.00	97-99	Org.-Nr. →8575	JBH,LLE	ATE
						BSY	F 026	003 501			
			06.00-10.03	97-99	Org.-Nr. 8576→	LLE	BSY	F 026	003 350	23,81	



	1.6i	10.00-10.03	74		LLE	BO	0 204 125 514		
		ABO 05.97-02.98	65-66	Org.-Nr. →7737	LLE	BSY	0 204 125 079		
		03.98-10.03	65-66	Org.-Nr. 7738→	LLE	BSY	0 204 125 134		
		10.00-10.03	74		LLE	BSY	0 204 125 134		
					RLE	BSY	0 204 125 514		
		ABS 06.00-10.03	65-66	Org.-Nr. 8576→	LLE	BSY	0 204 125 514		
					RLE	BSY	0 204 125 134		
		10.00-10.03	74		RLE	BSY	0 204 125 134		
		1.8i	ABO 05.97-10.03	74-76			BSY	0 204 125 134	
		1.8i	ABS 06.00-10.03	74-76/81	Org.-Nr. 8576→	LLE	BSY	0 204 125 514	
1.8i 16V				RLE	BSY	0 204 125 134			
1.8i 16V	ABO 05.97-02.98	81	Org.-Nr. →7744		BSY	0 204 125 134			
2.0i 16V	ABO 05.97-02.98	97-99	Org.-Nr. →7744	LLE	BSY	0 204 125 134			
	ABS 06.00-10.03	97-99	Org.-Nr. 8576→	LLE	BSY	0 204 125 514			
				RLE	BSY	0 204 125 134			













	1.6i	10.00-10.03	74				0 204 131 270 ^A		
		ABS 05.97-05.98	65-66	Org.-Nr. →7846	NOR		0 204 131 268 ^A		
					VFG		0 204 131 269 ^A		
		06.98-10.03	65-66	Org.-Nr. 7847→			0 204 131 270 ^A		
		1.8i	ABS 05.97-05.98	74-76	Org.-Nr. →7846	NOR		0 204 131 268 ^A	
					VFG		0 204 131 269 ^A		
		06.98-10.03	74-76	Org.-Nr. 7847→			0 204 131 270 ^A		
		1.8i 16V	05.97-05.98	81	Org.-Nr. →7846	NOR		0 204 131 268 ^A	
					VFG		0 204 131 269 ^A		
		06.98-10.03	81	Org.-Nr. 7847→			0 204 131 270 ^A		
2.0i 16V	05.97-05.98	97-99	Org.-Nr. →7846	NOR		0 204 131 268 ^A			
	06.98-10.03	97-99	Org.-Nr. 7847→			0 204 131 270 ^A			

	1.6i	05.97-10.03	65-66/74		BKR,STB		0 265 216 483 ^B		
		1.8i	05.97-10.03	74-76		BKR,STB		0 265 216 483 ^B	
		1.8i 16V	05.97-06.00	81	Org.-Nr. →8609	4SB,BKR		0 265 216 699 ^B	
			05.97-10.03	81		4SB,BKR		0 265 216 484 ^B	
			07.00-10.03	81	Org.-Nr. 8610→	4SB,BKR		0 265 216 723 ^B	
		2.0i 16V	05.97-06.00	97-99	Org.-Nr. →8609	4SB,BKR		0 265 216 699 ^B	
			05.97-10.03	97-99		4SB,BKR		0 265 216 484 ^B	
			07.00-10.03	97-99	Org.-Nr. 8610→	4SB,BKR		0 265 216 723 ^B	

306 [N3]

	1.1i	ABO 01.93-04.97	40/44	Fg.-Nr. →31153000	LWG	BSY		0 204 124 069 ⁶				
					JBH,LWG	BSY	F 026 003 170	20,6				
					LWG	BSY		0 204 124 068 ⁶				
					JBH,LWG	BSY	F 026 003 168	19				
					JBH	ATE	F 026 003 168	19				
					1.4	01.93-04.97	44/55	Fg.-Nr. →31153000	FAH,LWG			0 204 124 069 ⁶
					1.4i			Fg.-Nr. 31153001→	FAH,JBH,LWG		F 026 003 170	20,6
								Fg.-Nr. 31153001→	FAH,JBH,LWG		F 026 003 342	20,6
								Fg.-Nr. 31153000	LWG	BSY		0 204 124 068 ⁶
								Fg.-Nr. →31153000	JBH,LWG	BSY	F 026 003 168	19
								Fg.-Nr. S31153001→	JBH	ATE	F 026 003 168	19
								Fg.-Nr. 31153001→	JBH,LLE	ATE	0 986 480 835	20,6
								Fg.-Nr. 31153001→	LWG	BSY		0 204 124 143 ⁶
								Fg.-Nr. 31153001→	JBH,LWG	BSY	F 026 003 207	19
						ABS 01.93-04.97	44/55	Fg.-Nr. →30209024		BSY	0 204 123 172	20,6
			Fg.-Nr. 30209025→31153000		BSY			0 204 124 063 ⁶				
				JBH	BSY	F 026 003 174	22,2					

		S							
◀ PEUGEOT 306 [N3]									
1.6 i	ABO	01.93-04.97	65-66	Fg.-Nr. →31153000	JBH	ATE	F 026	003 170	20,6
						BSY	F 026	003 170	20,6
				Fg.-Nr. S31153001→	JBH,LLE	ATE	0986	480 835	20,6
				Fg.-Nr. 31153001→	JBH	BSY	F 026	003 342	20,6
ABS	01.93-04.97	65-66	Fg.-Nr. →30209024	Fg.-Nr. 30209025→31153000	JBH	BSY	0 204	123 172	20,6
						BSY			0 204 124 064 ⁶
					JBH	BSY	F 026	003 174	22,2
1.8 D	ABO	01.93-04.97	44/74-76	Fg.-Nr. →31153000	JBH	ATE	F 026	003 170	20,6
1.8 i				Fg.-Nr. S31153001→	JBH,LLE	ATE	0986	480 835	20,6
						BSY	F 026	003 342	20,6
	ABS	01.93-04.97	44/74-76	Fg.-Nr. →30209024	JBH	BSY	0 204	123 172	20,6
				Fg.-Nr. 30209025→31153000	JBH	BSY			0 204 124 063 ⁶
					JBH	BSY	F 026	003 174	22,2
1.9 D	ABS	05.93-04.97	47-48	Fg.-Nr. →30209024	JBH	BSY	0 204	123 172	20,6
				Fg.-Nr. 30209025→31153000	JBH	BSY			0 204 124 063 ⁶
					JBH	BSY	F 026	003 174	22,2
			51	Fg.-Nr. →30209024	JBH	BSY	0 204	123 172	20,6
				Fg.-Nr. 30209025→31153000	JBH	BSY			0 204 124 063 ⁶
					JBH	BSY	F 026	003 174	22,2
		07.94-04.97	50	Fg.-Nr. 30209025→31153000	JBH	BSY			0 204 124 063 ⁶
					JBH	BSY	F 026	003 174	22,2
1.9 D Turbo	ABS	05.93-04.97	66-67/68	Fg.-Nr. →S31153000	JBH	BSY			0 204 124 063 ⁶
					JBH	BSY	F 026	003 174	22,2
1.9 D	ABO	05.93-04.97	47-48/50/	Fg.-Nr. →31153000	JBH	ATE	F 026	003 170	20,6
1.9 D Turbo			51/66-67/		JBH	BSY	F 026	003 170	20,6
			68	Fg.-Nr. S31153001→	JBH,LLE	ATE	0986	480 835	20,6
				Fg.-Nr. 31153001→	JBH	BSY	F 026	003 342	20,6
2.0 i		08.93-04.97	89-90/			BSY			0 204 124 063 ⁶
2.0 i 16V			110-114		JBH	BSY	F 026	003 174	22,2
2.0 i 16V	ABS	07.96-04.97	120			LLE	BSY	0 204	123 343
						RLE	BSY	0 204	123 344
1.1 i	ABO	01.93-04.97	40/44			BD8	BSY	0 204	125 079
						LLE	ATE	0986	485 104
						BSY	0 204	125 134	
1.4	ABO	01.93-04.97	44		BD8	BSY	0 204	125 079	
1.4	ABO	01.93-04.97	55		BD8	BSY	0 204	125 079	
1.4 i				Fg.-Nr. →S31153000	TD8	ATE	0986	485 104	
1.6 i	ABO	01.93-04.97	65-66	Fg.-Nr. →31153000	JBH	BD8	BSY	0 204	125 079
						TD8	ATE	0986	485 105
	ABS	01.93-04.97	65-66	Fg.-Nr. →31153000	JBH	BSY	0 204	125 134	
1.8 D	ABO	05.93-04.97	44	Fg.-Nr. →31153000	JBH	BSY	0 204	125 079	
					TD8	ATE	0986	485 105	
1.8 i	ABS	01.93-04.97	74-76	Fg.-Nr. →31153000	JBH	BSY	0 204	125 134	
1.9 D	ABO	05.93-04.97	47-48/50/	Fg.-Nr. →31153000	JBH	BSY	0 204	125 079	
1.9 D Turbo			51/66-67/		TD8	ATE	0986	485 105	
			68						
	ABS	05.93-04.97	47-48/50/	Fg.-Nr. →31153000	JBH	BSY	0 204	125 134	
			51/66-67/						
			68						
2.0 i		08.93-04.97	89-90/110-114/			BSY	0 204	125 134	
2.0 i 16V			120						
1.1 i		01.93-04.97	40/44			LWG		0 204	131 067 ^A
						LWG		0 204	131 067 ^A
1.4		01.93-04.97	55			LWG		0 204	131 067 ^A
1.4 i	ABS	01.93-04.97	44/55					0 204	131 048
1.6 i	ABS	01.93-04.97	65-66					0 204	131 048
1.8 D		05.93-04.97	44			LWG		0 204	131 067 ^A
1.8 i	ABS	01.93-04.97	74-76					0 204	131 067 ^A
1.9 D		05.93-04.97	47-48/50/51			LWG		0 204	131 067 ^A
						LWG		0 204	131 067 ^A
	ABS	05.93-04.97	47-48/50/51					0 204	131 048
1.9 D Turbo	ABS	05.93-04.97	66-67/68					0 204	131 067 ^A

		S							
2.0i		ABO	08.93-04.97	89-90/110-114			0 204 131 069		
2.0i 16V		ABS	08.93-04.97	89-90/110-114			0 204 131 067 ^A		
2.0i 16V		ABS	07.96-04.97	120			0 204 131 256 ^A		
 1.1i			01.93-09.95	40/44		BO	0 265 208 321 ^B		
			10.95-04.97	40/44		BO	0 265 216 340 ^B		
1.4			01.93-09.95	44/55		BO	0 265 208 321 ^B		
1.4i			10.95-04.97	44/55		BO	0 265 216 340 ^B		
1.6i			01.93-09.95	65-66		BO	0 265 208 321 ^B		
			10.95-04.97	65-66		BO	0 265 216 340 ^B		
1.8D			01.93-09.95	44/74-76		BO	0 265 208 321 ^B		
1.8i			10.95-04.97	44/74-76		BO	0 265 216 340 ^B		
1.9D			05.93-09.95	47-48		BO	0 265 208 321 ^B		
1.9D			05.93-09.95	50/51/66-67/68		BO	0 265 208 321 ^B		
1.9D Turbo			10.95-04.97	50/51/66-67/68		BO	0 265 216 340 ^B		
2.0i			08.93-09.95	89-90/110-114		BO	0 265 208 321 ^B		
2.0i 16V			10.95-04.97	89-90/110-114		BO	0 265 216 340 ^B		
2.0i 16V			07.96-04.97	120		BO	0 265 216 340 ^B		
 1.1i			01.93-09.95	40/44	TEI	BO	2 267 000 735 ^H		
			10.95-04.97	40/44	HTB	BO	1 267 000 828 ^H		
1.4			01.93-09.95	44/55	TEI	BO	2 267 000 735 ^H		
1.4i			10.95-04.97	44/55	HTB	BO	1 267 000 828 ^H		
1.6i			01.93-09.95	65-66	TEI	BO	2 267 000 735 ^H		
			10.95-04.97	65-66	HTB	BO	1 267 000 828 ^H		
1.8D			01.93-09.95	44/74-76	TEI	BO	2 267 000 735 ^H		
1.8i			10.95-04.97	44/74-76	HTB	BO	1 267 000 828 ^H		
1.9D			05.93-09.95	47-48	TEI	BO	2 267 000 735 ^H		
1.9D			05.93-09.95	50/51/66-67/68	TEI	BO	2 267 000 735 ^H		
1.9D Turbo			10.95-04.97	50/51/66-67/68	HTB	BO	1 267 000 828 ^H		
2.0i			08.93-09.95	89-90/110-114	TEI	BO	2 267 000 735 ^H		
2.0i 16V			10.95-04.97	89-90/110-114	SBR,TEI		1 267 000 821 ^H		
2.0i 16V			07.96-04.97	120	SBR,TEI		1 267 000 821 ^H		
306 [N5]									
									
 1.4		ABS	06.00-10.03	55	Org.-Nr. 8576→	LLE	BSY	F 026 003 350	23,81
1.4		ABO	05.97-10.03	55		JBH	ATE	0 986 480 939	20,64
1.4i							BSY	F 026 003 349	20,64
		ABS	05.97-05.00	55	Org.-Nr. →8575	JBH,LLE	ATE	0 986 480 854	22,2
							BSY	F 026 003 501	
1.4i		ABS	06.00-10.03	55	Org.-Nr. 8576→	LLE	BSY	F 026 003 350	23,81
			10.00-10.03	55		LLE	BSY	F 026 003 350	23,81
1.6i		ABO	05.97-10.03	65-66/74		JBH	ATE	0 986 480 939	20,64
							BSY	F 026 003 349	20,64
		ABS	05.97-05.00	65-66	Org.-Nr. →8575	JBH,LLE	ATE	0 986 480 854	22,2
							BSY	F 026 003 501	
			06.00-10.03	65-66	Org.-Nr. 8576→	LLE	BSY	F 026 003 350	23,81
			10.00-10.03	74		LLE	BSY	F 026 003 350	23,81
1.8D		ABO	05.97-10.03	44/74-76		JBH,LLE	ATE	0 986 480 939	20,64
1.8i							BSY	F 026 003 349	20,64
						JBH,RLE	BSY	F 026 003 342	20,6
1.8D, i, i 16V		ABS	05.97-05.00	44/74-76/ 81	Org.-Nr. →8575	JBH,LLE	ATE	0 986 480 854	22,2
			06.00-10.03	44/74-76/ 81	Org.-Nr. 8576→	LLE	BSY	F 026 003 350	23,81
1.8i 16V		ABO	05.97-10.03	81		JBH,LLE	ATE	F 026 003 502	22,2
1.9D		ABO	05.97-10.03	50/51		JBH,LLE	ATE	0 986 480 939	20,64
							BSY	F 026 003 349	20,64
						JBH,RLE	BSY	F 026 003 342	20,6
			09.99-10.03	52		JBH,LLE	ATE	0 986 480 939	20,64
							BSY	F 026 003 349	20,64





	◀ PEUGEOT 306 [N5]									
1.9 D	ABS	05.97-05.00	50/51	Org.-Nr. →8575	JBH,LLE	ATE	0986 480 854	22,2		
						BSY	F 026 003 501			
		09.99-05.00	52	Org.-Nr. →8575	JBH,LLE	ATE	0986 480 854	22,2		
		06.00-10.03	50/51	Org.-Nr. 8576→	LLE	BSY	F 026 003 350	23,81		
1.9 D Turbo	ABO	05.97-10.03	55/66		JBH,LLE	ATE	F 026 003 502	22,2		
	ABS	05.97-05.00	55/66	Org.-Nr. →8575	JBH,LLE	ATE	0986 480 854	22,2		
			06.00-10.03	55/66	Org.-Nr. 8576→	LLE	BSY	F 026 003 350	23,81	
2.0 HDi	ABO	05.97-10.03	66/97-99		JBH,LLE	ATE	F 026 003 502	22,2		
2.0 i 16V	ABS	05.97-05.00	66/97-99	Org.-Nr. →8575	JBH,LLE	ATE	0986 480 854	22,2		
			06.00-10.03	66/97-99	Org.-Nr. 8576→	LLE	BSY	F 026 003 501		
		06.00-10.03	66/97-99	Org.-Nr. 8576→	LLE	BSY	F 026 003 350	23,81		
2.0 i 16V	ABO	05.97-10.03	120			BSY	0 204 123 373	23,81		
	ABS	05.97-10.03	120		LLE	BSY	F 026 003 350	23,81		

	1.4	ABO	05.97-10.03	55			BSY	0 204 125 514		
		ABS	06.00-10.03	55	Org.-Nr. 8576→	LLE	BSY	0 204 125 514		
						RLE	BSY	0 204 125 134		
1.4 i			10.00-10.03	55		LLE	BO	0 204 125 514		
	ABO	05.97-10.03	55			BSY	0 204 125 514			
			10.00-10.03	55		RLE	BSY	0 204 125 514		
ABS	06.00-10.03	55	Org.-Nr. 8576→	LLE	BSY	0 204 125 514				
					RLE	BSY	0 204 125 134			
		10.00-10.03	55		RLE	BSY	0 204 125 134			
1.6 i			10.00-10.03	74		LLE	BO	0 204 125 514		
	ABO	05.97-10.03	65-66			BSY	0 204 125 514			
			10.00-10.03	74		RLE	BSY	0 204 125 514		
ABS	06.00-10.03	65-66	Org.-Nr. 8576→	LLE	BSY	0 204 125 514				
					RLE	BSY	0 204 125 134			
		10.00-10.03	74		RLE	BSY	0 204 125 134			
1.8 D	ABO	05.97-10.03	44		LLE	BSY	0 204 125 514			
					RLE	BSY	0 204 125 134			
1.8 i	ABO	05.97-10.03	74-76			BSY	0 204 125 134			
1.8 i	ABS	06.00-10.03	74-76/81	Org.-Nr. 8576→	LLE	BSY	0 204 125 514			
1.8 i 16V					RLE	BSY	0 204 125 134			
1.9 D	ABO	05.97-10.03	50/51		LLE	BSY	0 204 125 514			
			09.99-10.03	52		LLE	BSY	0 204 125 514		
	ABS	06.00-10.03	51/52	Org.-Nr. 8576→	LLE	BSY	0 204 125 514			
2.0 HDi	ABS	06.00-10.03	66/97-99	Org.-Nr. 8576→	LLE	BSY	0 204 125 514			
2.0 i 16V					RLE	BSY	0 204 125 134			
2.0 i 16V		05.97-10.03	120		LLE		0 204 125 514			
					RLE		0 204 125 134			

	1.4	ABS	05.97-05.98	55	Org.-Nr. →7846	VFG		0 204 131 269 ^A				
			06.98-10.03	55	Org.-Nr. 7847→			0 204 131 270 ^A				
1.4, i	ABS	05.97-05.98	55	Org.-Nr. →7846	NOR			0 204 131 268 ^A				
1.4 i			05.97-05.98	55	Org.-Nr. →7846	LWG		0 204 131 269 ^A				
			06.98-10.03	55	Org.-Nr. 7847→			0 204 131 270 ^A				
			10.00-10.03	55				0 204 131 270 ^A				
ABS	05.97-05.98	55	Org.-Nr. →7846	VFG			0 204 131 269 ^A					
					1.6 i	10.00-10.03	74			0 204 131 270 ^A		
					ABS	05.97-05.98	65-66	Org.-Nr. →7846	NOR		0 204 131 268 ^A	
	06.98-10.03	65-66	Org.-Nr. 7847→	VFG			0 204 131 269 ^A					
1.8 D			06.98-10.03	44	Org.-Nr. 7847→			0 204 131 270 ^A				
			ABS	05.97-05.98	44	Org.-Nr. →7846	LWG		0 204 131 269 ^A			
					NOR		0 204 131 268 ^A					
					VFG		0 204 131 269 ^A					
1.8 i	ABS	05.97-05.98	74-76	Org.-Nr. →7846	NOR			0 204 131 268 ^A				
						VFG		0 204 131 269 ^A				
			06.98-10.03	74-76	Org.-Nr. 7847→			0 204 131 270 ^A				

	S							
1.8 i 16V	05.97-05.98	81	Org.-Nr. →7846	NOR	0 204 131 268 ^A			
				VFG	0 204 131 269 ^A			
1.9 D	06.98-10.03	81	Org.-Nr. 7847→		0 204 131 270 ^A			
	06.98-10.03	50	Org.-Nr. 7847→		0 204 131 270 ^A			
		51	Org.-Nr. 7847→		0 204 131 270 ^A			
	09.98-10.03	51			0 204 131 270 ^A			
	09.99-10.03	52			0 204 131 270 ^A			
1.9 D Turbo	05.97-05.98	66	Org.-Nr. →7846	NOR	0 204 131 268 ^A			
	06.98-10.03	55	Org.-Nr. 7847→		0 204 131 270 ^A			
2.0 HDi	06.99-10.03	66	Org.-Nr. 7847→		0 204 131 270 ^A			
	06.99-10.03	66			0 204 131 270 ^A			
2.0 i 16V	05.97-05.98	97-99	Org.-Nr. →7846	NOR	0 204 131 268 ^A			
	05.97-10.03	120			0 204 131 271 ^A			
	06.98-10.03	97-99	Org.-Nr. 7847→		0 204 131 270 ^A			
1.4	05.97-10.03	55		BKR,STB	0 265 216 483 ^B			
	05.97-10.03	55		BKR,STB	0 265 216 723 ^B			
1.6 i	05.97-10.03	65-66/74		BKR,STB	0 265 216 483 ^B			
	05.97-10.03	65-66/74		BKR,STB	0 265 216 723 ^B			
1.8 D	05.97-10.03	44/74-76		BKR,STB	0 265 216 483 ^B			
1.8 i	05.97-10.03	44/74-76		BKR,STB	0 265 216 723 ^B			
1.8 i 16V	05.97-06.00	81	Org.-Nr. →8609	4SB,BKR	0 265 216 699 ^B			
	05.97-10.03	81		4SB,BKR	0 265 216 484 ^B			
	07.00-10.03	81	Org.-Nr. 8610→	4SB,BKR	0 265 216 723 ^B			
1.9 D	05.97-10.03	50/51/52/		BKR,STB	0 265 216 483 ^B			
1.9 D Turbo	05.97-10.03	55/66		BKR,STB	0 265 216 723 ^B			
2.0 HDi	05.97-06.00	66/97-99/	Org.-Nr. →8609	4SB,BKR	0 265 216 699 ^B			
2.0 i 16V	05.97-10.03	120		4SB,BKR	0 265 216 484 ^B			
	05.97-10.03	66/97-99/		4SB,BKR	0 265 216 484 ^B			
	07.00-10.03	66/97-99/	Org.-Nr. 8610→	4SB,BKR	0 265 216 723 ^B			
		120						
307 Break/SW [T5]								
1.4 HDi, i	03.02-05.05	50/55			0 204 123 597	22,2		
	MFD 11.03-05.05	65			0 204 123 658	23,8		
1.4 i 16V	OFD 11.03-05.05	65			0 204 123 597	22,2		
	03.02-05.05	65			0 204 123 597	22,2		
1.6 HDi	MFD 02.04-05.05	66			0 204 123 658	23,8		
		80			0 204 123 658	23,8		
	OFD 02.04-04.05	66	Org.-Nr. →10397		0 204 123 595	23,81		
		80			0 204 123 595	23,81		
		05.05-05.05	66	Org.-Nr. 10398→		0 204 123 597	22,2	
1.6 i	03.02-05.05	80		TW	0 204 123 595	23,81		
		80			0 204 123 596	23,81		
		80			0 204 123 598	22,2		
		80			0 204 123 658	23,8		
2.0 HDi	03.02-05.05	66		KZO	0 204 123 597	22,2		
		66		KZO	0 204 123 596	23,81		
		79		FAH,KZO	0 204 123 597	22,2		
		79		FAH,KZO	0 204 123 595	23,81		
		79		FAH,KZO	0 204 123 596	23,81		
2.0 HDi	03.02-05.05	100		TW	0 204 123 595	23,81		
2.0 i	03.02-05.05	100			0 204 123 596	23,81		
	03.02-05.05	100			0 204 123 658	23,8		
1.4 HDi, i	03.02-05.05	50/55			0 204 125 776			
	MFD 11.03-05.05	65			0 204 125 823			
	OFD 11.03-05.05	65			0 204 125 776			



◀ PEUGEOT 307 Break/SW [T5]									
1.6 HDi	MFD	02.04-05.05	66					0 204 125 823	
			80					0 204 125 823	
	OFD	02.04-04.05	66	Org.-Nr. →10397				0 204 125 777	
		02.04-05.05	80					0 204 125 777	
		05.05-05.05	66	Org.-Nr. 10398→				0 204 125 776	
1.6 i		03.02-05.05	80					0 204 125 823	
						25D		0 204 125 777	
2.0 HDi		03.02-05.05	66					0 204 125 776	
						KZO		0 204 125 777	
			79					0 204 125 776	
						25D		0 204 125 777	
2.0 HDi		03.02-05.05	100				0 204 125 823		
2.0 i						25D	0 204 125 777		
1.4 HDi		03.02-05.05	50					0 265 216 758 ^H	
								0 265 225 189 ^M	
								0 265 231 487 ^H	
								0 265 234 459 ^M	
1.4 i		03.02-05.05	55					0 265 216 758 ^H	
								0 265 231 487 ^H	
1.4 i 16V		11.03-05.05	65					0 265 231 487 ^H	
								0 265 234 459 ^M	
1.6 HDi		02.04-05.05	66					0 265 231 487 ^B	
			80					0 265 231 487 ^H	
								0 265 234 459 ^M	
		02.05-05.05	66	Org.-Nr. 10283→				0 265 234 459 ^T	
1.6 i		03.02-05.05	80					0 265 216 758 ^H	
								0 265 225 189 ^M	
								0 265 231 487 ^H	
								0 265 234 459 ^M	
2.0 HDi		03.02-05.05	66/79					0 265 216 758 ^H	
								0 265 225 189 ^M	
								0 265 231 487 ^H	
								0 265 234 459 ^M	
								0 265 225 189 ^M	
		10.03-05.05	100					0 265 234 459 ^M	
2.0 i		03.02-05.05	100					0 265 231 487 ^B	
								0 265 231 487 ^H	
								0 265 234 459 ^T	
1.4 HDi, i 16V		03.02-05.05	50/65					0 265 005 290	
	1.6 HDi, i	03.02-05.05	66/80					0 265 005 290	
		03.02-05.05	66/79/100					0 265 005 290	

307 Break/SW [T6]

307 Break/SW [T6]										
1.4 i	MFD	06.05-05.08	65					0 204 123 658	23,8	
	OFD	06.05-05.08	65					0 204 123 597	22,2	
	1.6 HDi		06.07-07.07	66	Org.-Nr. →11192				0 204 123 595	23,81
		MFD	06.05-07.07	66	Org.-Nr. →11192				0 204 123 658	23,8
			08.07-05.08	66	Org.-Nr. 11193→				0 204 123 736	23,81
		OFD	06.05-07.07	66	Org.-Nr. →11192				0 204 123 597	22,2
			08.07-05.08	66	Org.-Nr. 11193→				0 204 123 737	
	1.6 HDi	MFD	06.05-12.09	80				0 204 123 658	23,8	
	1.6 i 16V	OFD	06.05-12.09	80			AG	0 204 123 596	23,81	
	1.6 i 16V BioFlex						GS	0 204 123 595	23,81	
	2.0 HDi		06.05-05.08	100				0 204 123 658	23,8	
	2.0 i	MFD	06.05-05.08	103					0 204 123 658	23,8
		OFD	06.05-05.08	103				AG	0 204 123 596	23,81
							GS	0 204 123 595	23,81	

		S							
	1.4 i	MFD	06.05-05.08	65			0 204 125 823		
		OFD	06.05-05.08	65			0 204 125 776		
	1.6 HDi		06.05-05.08	66			0 204 125 823		
		MFD	06.07-07.07	66	Org.-Nr. →11192		0 204 125 823		
			08.07-05.08	66	Org.-Nr. 11193→		0 204 125 902		
		OFD	06.05-05.08	66			0 204 125 776		
	1.6 HDi, i 16V, i 16V BioFlex	MFD	06.05-12.09	80			0 204 125 823		
		OFD	06.05-12.09	80			0 204 125 777		
			06.07-07.07	66	Org.-Nr. →11192		0 204 125 777		
	2.0 HDi		06.05-05.08	100			0 204 125 823		
MFD		06.05-05.08	103			0 204 125 823			
2.0 i		06.05-05.08	103			0 204 125 901			
	OFD	06.05-05.08	103			0 204 125 777			
	1.4 i		06.05-05.08	65			0 265 231 487^B		
							0 265 234 459^T		
	1.6 HDi, i 16V, i 16V BioFlex		06.05-12.09	66/80			0 265 231 487^B		
							0 265 234 459^T		
2.0 HDi		06.05-05.08	100/103			0 265 231 487^B			
						0 265 234 459^T			
	1.4 i		06.05-05.08	65			0 265 005 606		
		1.6 HDi		06.05-05.08	66			0 265 005 606	
			06.07-05.08	66			0 265 005 765		
	1.6 HDi, i 16V, i 16V BioFlex		06.05-12.09	80			0 265 005 606		
2.0 HDi, i		06.05-05.08	100/103			0 265 005 606			
307 CC [T5]									
	2.0 i		10.03-05.05	100		TW	0 204 123 595	23,81	
							0 204 123 596	23,81	
							0 204 123 658	23,8	
2.0 i Sport		10.03-05.05	130			TW	0 204 123 595	23,81	
							0 204 123 658	23,8	
	2.0 i		10.03-05.05	100/130			0 204 125 823		
		2.0 i Sport					25D	0 204 125 777	
	2.0 i		10.03-05.05	100		TW	0 265 225 216^M		
							0 265 216 758^H		
							0 265 231 487^B		
							0 265 231 487^H		
							0 265 234 459^M		
						0 265 234 459^T			
	2.0 i Sport	10.03-05.05	130			TW	0 265 225 216^M		
						0 265 216 758^H			
						0 265 231 487^H			
						0 265 234 459^M			
	2.0 i		10.03-05.05	100/130			0 265 005 290		
		2.0 i Sport							
307 CC [T6]									
	1.6 i	MFD	06.05-03.09	80			0 204 123 658	23,8	
		OFD	06.05-03.09	80			AG	0 204 123 596	23,81
							GS	0 204 123 595	23,81
2.0 HDi		06.05-07.07	100/130	Org.-Nr. →11192			0 204 123 658	23,8	
	2.0 i Sport	08.07-03.09	100/130	Org.-Nr. 11193→			0 204 123 736	23,81	



			S								
PEUGEOT 307 CC [T6]											
	2.0 i	MFD	06.05-07.07	103	Org.-Nr. →11192 88, →11192 89			0 204 123 658	23,8		
			08.07-03.09	103	Org.-Nr. 11187 UW→, 11193 88→, 11193 89→			0 204 123 736	23,81		
		OFD	06.05-07.07	103	Org.-Nr. →11192 88,	GS		0 204 123 595	23,81		
					→11192 89						
					Org.-Nr. →11192 89,	AG		0 204 123 596	23,81		
			→11192 88								
			08.07-03.09	103	Org.-Nr. 11187 UW→, 11193 89→, 11193 88→			0 204 123 737			
	1.6 i	MFD	06.05-03.09	80				0 204 125 823			
		OFD	06.05-03.09	80				0 204 125 777			
	2.0 HDi		06.05-07.07	100/130	Org.-Nr. →11192			0 204 125 823			
	2.0 i Sport		08.07-03.09	100/130	Org.-Nr. 11193→			0 204 125 902			
	2.0 i	MFD	06.05-03.09	103	Org.-Nr. 10367 88→, 10367 88→			0 204 125 823			
	OFD	06.05-03.09	103	Org.-Nr. 10367 88→, 10367 89→			0 204 125 777				
	1.6 i		06.05-03.09	80			TW	0 265 231 487 ^B			
								0 265 234 459 ^T			
	2.0 HDi, i, i Sport		06.05-03.09	100/103/130			TW	0 265 231 487 ^B			
								0 265 234 459 ^T			
	1.6 i		06.05-03.09	80			TW	0 265 005 606			
								0 265 005 765			
	2.0 HDi, i, i Sport		06.05-03.09	100/103/130			TW	0 265 005 606			
								0 265 005 765			
307 Sedan [T6]											
	2.0 i 16V	MFD	08.07-01.12	105	Org.-Nr. 11193→			0 204 123 736	23,81		
		OFD	08.06-01.12	105			AG	0 204 123 596	23,81		
							GS	0 204 123 595	23,81		
			08.07-01.12	105	Org.-Nr. 11193→			0 204 123 737			
	2.0 i 16V	MFD	08.06-07.07	105	Org.-Nr. →11192			0 204 125 823			
			08.07-01.12	105	Org.-Nr. 11193→			0 204 125 902			
		OFD	08.06-07.07	105	Org.-Nr. →11192			0 204 125 777			
			08.07-01.12	105	Org.-Nr. 11193→			0 204 125 901			
307 [T5]											
	1.4 HDi		10.01-05.05	50				0 204 123 597	22,2		
	1.4 i		08.00-05.05	55			TW	0 204 123 597	22,2		
								0 204 123 658	23,8		
	1.4 i 16V	MFD	11.03-05.05	65				0 204 123 658	23,8		
		OFD	11.03-05.05	65				0 204 123 597	22,2		
	1.6 HDi	MFD	02.04-05.05	66				0 204 123 658	23,8		
				80				0 204 123 658	23,8		
		OFD	02.04-04.05	66	Org.-Nr. →10397			0 204 123 595	23,81		
			02.04-05.05	80				0 204 123 595	23,81		
			05.05-05.05	66	Org.-Nr. 10398→			0 204 123 597	22,2		
	1.6 i		08.00-05.05	80			TW	0 204 123 595	23,81		
								0 204 123 596	23,81		
								0 204 123 598	22,2		
								0 204 123 658	23,8		
	1.6 i 16V		06.04-04.06	81	Org.-Nr. →09927			0 204 123 598	22,2		
					Org.-Nr. 09928→			0 204 123 595	23,81		
	2.0 HDi		08.00-05.05	66			KZØ	0 204 123 597	22,2		
							KZO	0 204 123 596	23,81		

		S							
2.0 HDi		03.02-05.05	79			FAH, KZO	0 204 123 597	22,2	
						FAH, KZO	0 204 123 595	23,81	
						FAH, KZO	0 204 123 596	23,81	
2.0 HDi		08.00-05.05	100			TW	0 204 123 595	23,81	
2.0 i							0 204 123 596	23,81	
							0 204 123 658	23,8	
2.0 i 16V		MFD 06.04-04.06	105				0 204 123 658	23,8	
		OFD 06.04-04.06	105			AG	0 204 123 596	23,81	
						GS	0 204 123 595	23,81	
1.4 HDi		10.01-05.05	50				0 204 125 776		
1.4 i		08.00-05.05	55				0 204 125 823		
						225	0 204 125 776		
1.4 i 16V		MFD 11.03-05.05	65				0 204 125 823		
		OFD 11.03-05.05	65				0 204 125 776		
1.6 HDi		MFD 02.04-05.05	66				0 204 125 823		
			80				0 204 125 823		
		OFD 02.04-04.05	66	Org.-Nr. →10397			0 204 125 777		
		02.04-05.05	80				0 204 125 777		
		05.05-05.05	66	Org.-Nr. 10398→			0 204 125 776		
1.6 i		08.00-05.05	80				0 204 125 823		
						25D	0 204 125 777		
1.6 i 16V		MFD 06.04-04.06	81				0 204 125 823		
		OFD 06.04-04.06	81				0 204 125 777		
2.0 HDi		08.00-05.05	66			KZO	0 204 125 776		
						KZO	0 204 125 777		
		03.02-05.05	79			225	0 204 125 776		
						25D	0 204 125 777		
2.0 HDi		08.00-05.05	100				0 204 125 823		
2.0 i						25D	0 204 125 777		
2.0 i 16V		MFD 06.04-04.06	105				0 204 125 823		
		OFD 06.04-04.06	105				0 204 125 777		
1.4 HDi		08.00-05.05	50/55			TW	0 265 216 758 ^H		
1.4 i							0 265 225 189 ^M		
							0 265 231 565 ^H		
							0 265 234 459 ^M		
1.4 i 16V		11.03-05.05	65				0 265 231 565 ^H		
							0 265 234 459 ^M		
1.6 HDi		02.04-05.05	66			TW	0 265 231 487 ^B		
			80				0 265 231 565 ^H		
							0 265 234 459 ^M		
		02.05-05.05	66	Org.-Nr. 10283→			0 265 234 459 ^T		
1.6 i		08.00-05.05	80			TW	0 265 231 487 ^B		
							0 265 234 459 ^T		
1.6 i 16V		06.04-04.06	81				0 265 231 487 ^B		
						TW	0 265 216 758 ^H		
2.0 HDi		08.00-05.05	66/79			TW	0 265 216 758 ^H		
							0 265 225 189 ^M		
							0 265 231 565 ^H		
							0 265 234 459 ^M		
		10.03-05.05	100			TW	0 265 225 189 ^M		
							0 265 234 459 ^M		
2.0 i		08.00-05.05	100			TW	0 265 231 487 ^B		
							0 265 234 459 ^T		
2.0 i 16V		06.04-04.06	105				0 265 231 487 ^B		
						TW	0 265 216 758 ^H		
1.4 HDi, i, i 16V		08.00-05.05	50/55/65				0 265 005 290		
1.6 HDi, i		08.00-05.05	66/80				0 265 005 290		
2.0 HDi, i		08.00-05.05	66/79/100				0 265 005 290		



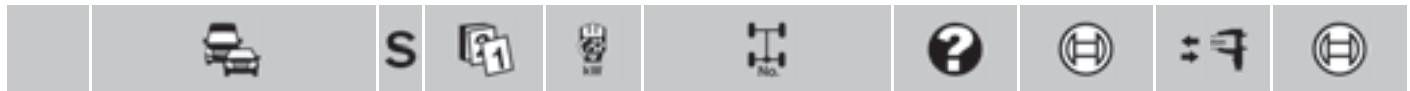

◀ PEUGEOT

307 [T6]



	1.4 i	MFD	06.05-08.07	65		0 204 123 658	23,8
		OFD	06.05-08.07	65		0 204 123 597	22,2
1.6 HDi	05.06-07.07	66	Org.-Nr. →11192		0 204 123 595	23,81	
		MFD	06.05-08.07	66		0 204 123 658	23,8
	08.07-08.07	66	Org.-Nr. 11193→		0 204 123 736	23,81	
		OFD	06.05-08.07	66		0 204 123 597	22,2
1.6 HDi	08.07-08.07	66	Org.-Nr. 11193→		0 204 123 737		
		MFD	06.05-08.07	80		0 204 123 658	23,8
1.6 i	06.05-08.07	80		AG	0 204 123 596	23,81	
		OFD	06.05-08.07	80		0 204 123 595	23,81
2.0 HDi, i	06.05-08.07	100/130			0 204 123 658	23,8	
		MFD	06.05-07.07	103	Org.-Nr. →11192 88, →11192 89	0 204 123 658	23,8
2.0 i	08.07-08.07	103	Org.-Nr. 11187 UW→, 11193 88→, 11193 89→		0 204 123 736	23,81	
		OFD	06.05-07.07	103	Org.-Nr. →11192 88, →11192 89	0 204 123 595	23,81
	08.07-08.07	103	Org.-Nr. →11192 89, →11192 88	AG	0 204 123 596	23,81	
		OFD	06.05-07.07	103	Org.-Nr. 11187 UW→, 11193 89→, 11193 88→	0 204 123 737	

	1.4 i	MFD	06.05-08.07	65		0 204 125 823	
		OFD	06.05-08.07	65		0 204 125 776	
1.6 HDi	06.05-08.07	66			0 204 125 823		
		MFD	06.05-08.07	66	Org.-Nr. 11193→	0 204 125 902	
	08.07-08.07	66	Org.-Nr. 11193→		0 204 125 776		
		OFD	06.05-08.07	66		0 204 125 776	
1.6 HDi	05.06-07.07	66	Org.-Nr. →11192		0 204 125 777		
		MFD	06.05-08.07	80		0 204 125 823	
1.6 i	06.05-08.07	80			0 204 125 901		
		OFD	06.05-08.07	80		0 204 125 777	
2.0 HDi, i	06.05-08.07	100/130			0 204 125 823		
		MFD	06.05-08.07	103		0 204 125 823	
2.0 i	06.05-08.07	103			0 204 125 777		
		OFD	06.05-08.07	103			

	1.4 i	06.05-08.07		65		0 265 231 487 ^B	
						0 265 234 459 ^T	
1.6 HDi	06.05-08.07	66			0 265 231 487 ^B		
		80			0 265 234 459 ^T		
	06.05-08.07	80		TW	0 265 231 487 ^B		
		100			0 265 234 459 ^T		
2.0 HDi	06.05-08.07	100			0 265 231 487 ^B		
		130			0 265 234 459 ^T		
2.0 i	06.05-12.06	103			0 265 231 487 ^B		
		103		TW	0 265 234 459 ^T		

	1.4 i	06.05-08.07		65		0 265 005 606	
						0 265 005 606	
1.6 HDi	06.05-08.07	66			0 265 005 606		
		80			0 265 005 606		
1.6 i	04.07-08.07	66			0 265 005 765		
		80		TW	0 265 005 606		
2.0 HDi	06.05-08.07	100			0 265 005 765		
		100			0 265 005 606		
2.0 i	06.05-12.06	130			0 265 005 606		
		103		TW	0 265 005 606		
						0 265 005 765	



308 CC [T7]



	1.6 HDi	MFD 03.09→	82/84/88/103		0 204 123 736	23,81	
	1.6 THP	OFD 03.09→	82/84/88/		0 204 123 737		
	1.6 VTi		103/110				
	1.6 THP		09.09→	115/120		0 204 123 736	23,81
			01.11→	110		0 204 123 736	23,81
		MFD 03.09→		110		0 204 123 736	23,81
	1.6 THP GTi		05.10→	147		0 204 718 072	
	2.0 HDi		09.09→	110/120		0 204 123 736	23,81
			05.11→	100		0 204 123 736	23,81
		MFD 03.09→		100		0 204 123 736	23,81
			103		0 204 123 736	23,81	
	OFD 03.09→		100/103		0 204 123 737		

	1.6 THP		09.09-07.10	115	Org.-Nr. →12291	0 204 125 904		
			08.10→	115	Org.-Nr. 12292→	0 204 125 902		
			01.11→	110		0 204 125 902		
				120		0 204 125 902		
		MFD 03.09-07.10		103/110	Org.-Nr. →12291	0 204 125 904		
			08.10→	103/110	Org.-Nr. 12292→	0 204 125 902		
		OFD 03.09-07.10		103/110	Org.-Nr. →12291	0 204 125 903		
			08.10→	103/110	Org.-Nr. 12292→	0 204 125 901		
		1.6 THP GTi		05.10→	147		0 204 718 070	
		1.6 VTi	MFD 03.09→		88		0 204 125 902	
			OFD 03.09→		88		0 204 125 901	
		2.0 HDi		09.09-07.10	120	Org.-Nr. →12291	0 204 125 904	
				08.10→	120	Org.-Nr. 12292→	0 204 125 902	
				05.11→	100		0 204 125 902	
			MFD 03.09-07.10		100/103	Org.-Nr. →12291	0 204 125 904	
				08.10→	100/103	Org.-Nr. 12292→	0 204 125 902	
			OFD 03.09-07.10		100/103	Org.-Nr. →12291	0 204 125 903	
			08.10→	100/103	Org.-Nr. 12292→	0 204 125 901		

	2.0 HDi		03.09→	100/103/ 110/120		0 986 486 616	19
--	----------------	--	--------	---------------------	--	----------------------	----

	2.0 HDi		03.09→	100		0 265 230 502 ^T	
--	----------------	--	--------	-----	--	-----------------------------------	--

	1.6 HDi, THP, THP GTi, VTi		03.09→	82/84/88/103/110/115/120/147		0 265 005 765	
	2.0 HDi		03.09→	100/103/110/120		0 265 005 765	

308 SW [T7]



	1.4	MFD 05.08-01.14	70/72		0 204 123 736	23,81	
	1.4 VTi	OFD 05.08-01.14	70/72		0 204 123 737		
	1.6, BioFlex, HDi, THP, VTi	MFD 05.08-01.14	66/68/80/82/84/88/103		0 204 123 736	23,81	
		OFD 05.08-01.14	66/68/80/82/84/88/103/110/128		0 204 123 737		
	1.6 THP		04.10-01.14	115/120		0 204 123 736	23,81
			01.11-01.14	110		0 204 123 736	23,81
		MFD 05.08-04.10		110		0 204 123 736	23,81
				128		0 204 123 736	23,81
	2.0	MFD 05.08-01.14	100-103		0 204 123 736	23,81	
	2.0 HDi	OFD 05.08-01.14	100-103		0 204 123 737		
2.0 HDi		09.09-01.14	110/120		0 204 123 736	23,81	

	1.4	MFD 05.08-03.10	70		0 204 125 904	
		OFD 05.08-03.10	70		0 204 125 903	





◀ PEUGEOT 308 SW [T7]										
1.4 VTi	MFD	04.10-07.10	72	Org.-Nr. →12291		0 204 125 904				
		08.10-01.14	72	Org.-Nr. 12292→		0 204 125 902				
	OFD	04.10-07.10	72	Org.-Nr. →12291		0 204 125 903				
		08.10-01.14	72	Org.-Nr. 12292→		0 204 125 901				
1.6	MFD	05.08-01.14	88			0 204 125 904				
	OFD	05.08-01.14	88			0 204 125 903				
1.6 BioFlex	MFD	03.09-07.10	82	Org.-Nr. →12291		0 204 125 904				
1.6 HDi		08.10-03.13	82	Org.-Nr. 12292→		0 204 125 902				
	OFD	03.09-07.10	82	Org.-Nr. →12291		0 204 125 903				
		08.10-03.13	82	Org.-Nr. 12292→		0 204 125 901				
1.6 HDi	MFD	05.08-03.10	66			0 204 125 904				
			80			0 204 125 904				
		06.10-07.10	68	Org.-Nr. →12291		0 204 125 904				
		08.10-01.14	68	Org.-Nr. 12292→		0 204 125 902				
		11.10-01.14	80			0 204 125 902				
		01.11-01.14	68			0 204 125 902				
		01.13-01.14	84			0 204 125 902				
	OFD	05.08-03.10	66				0 204 125 903			
			80				0 204 125 903			
		06.10-07.10	68	Org.-Nr. →12291			0 204 125 903			
		08.10-01.14	68	Org.-Nr. 12292→			0 204 125 901			
		11.10-01.14	80				0 204 125 901			
		01.11-01.14	68				0 204 125 901			
		01.13-01.14	84				0 204 125 901			
1.6 THP		04.10-07.10	115	Org.-Nr. →12291		0 204 125 904				
		08.10-01.14	115	Org.-Nr. 12292→		0 204 125 902				
		01.11-01.14	110			0 204 125 902				
	MFD	05.08-04.10	103			TW	0 204 125 902			
			110			TW	0 204 125 902			
			128				0 204 125 904			
		05.08-04.10	103/110			TW	0 204 125 901			
	OFD		128				0 204 125 903			
			103				0 204 125 902			
			110				0 204 125 902			
			128				0 204 125 904			
1.6 VTi	MFD	12.09-07.10	88	Org.-Nr. →12291		0 204 125 904				
		08.10-01.14	88	Org.-Nr. 12292→		0 204 125 902				
		01.11-01.14	88			0 204 125 902				
	OFD	12.09-07.10	88	Org.-Nr. →12291		0 204 125 903				
		08.10-01.14	88	Org.-Nr. 12292→		0 204 125 901				
		01.11-01.14	88			0 204 125 901				
2.0	MFD	05.08-07.10	100-103	Org.-Nr. →12291		0 204 125 904				
		08.10-01.14	100-103	Org.-Nr. 12292→		0 204 125 902				
2.0 HDi	OFD	05.08-07.10	100-103	Org.-Nr. →12291		0 204 125 903				
		08.10-01.14	100-103	Org.-Nr. 12292→		0 204 125 901				
2.0 HDi		09.09-07.10	120	Org.-Nr. →12291		0 204 125 904				
		08.10-01.14	120	Org.-Nr. 12292→		0 204 125 902				
		10.10-01.14	110			0 204 125 902				
2.0 HDi		03.09-01.14	100-103	Org.-Nr. 11760→		0 986 486 616	19			
		09.09-01.14	110/120			0 986 486 616	19			
1.4		05.08-07.09	70	Org.-Nr. →11920		0 265 232 440 ^B				
		05.08-03.10	70			0 265 230 502 ^T				
1.6		05.08-07.09	66/80/82/	Org.-Nr. →11920		0 265 232 440 ^B				
1.6 BioFlex			88/103/							
1.6 HDi			110/128							
1.6 THP		05.08-01.14	66/80/82/88/			0 265 230 502 ^T				
			103/110/128							
2.0		05.08-07.09	103	Org.-Nr. →11920		0 265 232 440 ^B				
		05.08-04.12	103			0 265 230 502 ^T				

2.0 HDi	05.08-07.09	100-103	Org.-Nr. →11920			0 265 232 440 ^B		
	05.08-01.14	100-103			EU5	0 265 230 502 ^T		
1.4	05.08-11.08	70	Org.-Nr. →11682, Get.-Nr. MC manual			0 265 005 715		
			Org.-Nr. →11682, Get.-Nr. MC manual			0 265 005 765		
	12.08-03.10	70	Org.-Nr. 11683→			0 265 005 765		
1.4 VTi	04.10-01.14	72				0 265 005 765		
1.6	05.08-11.08	88	Org.-Nr. →11682, Get.-Nr. MC manual			0 265 005 715		
			Org.-Nr. →11682, Get.-Nr. MC manual			0 265 005 765		
	12.08-01.14	88	Org.-Nr. 11683→			0 265 005 765		
1.6 BioFlex, HDi	03.09-01.14	82/84				0 265 005 765		
1.6 HDi	05.08-11.08	66	Org.-Nr. →11682, Get.-Nr. MC manual			0 265 005 715		
			Org.-Nr. →11682, Get.-Nr. MC manual			0 265 005 765		
		80	Org.-Nr. →11682, Get.-Nr. MC manual			0 265 005 715		
			Org.-Nr. →11682, Get.-Nr. MC manual			0 265 005 765		
	12.08-03.10	66	Org.-Nr. 11683→			0 265 005 765		
		80	Org.-Nr. 11683→			0 265 005 765		
	06.10-01.14	68				0 265 005 765		
	11.10-01.14	80				0 265 005 765		
1.6 THP	05.08-11.08	103	Org.-Nr. →11682, Get.-Nr. MC manual			0 265 005 715		
			Org.-Nr. →11682, Get.-Nr. MC manual			0 265 005 765		
		110	Org.-Nr. →11682, Get.-Nr. MC manual			0 265 005 715		
			Org.-Nr. →11682, Get.-Nr. MC manual			0 265 005 765		
		128	Org.-Nr. →11682, Get.-Nr. MC manual			0 265 005 715		
			Org.-Nr. →11682, Get.-Nr. MC manual			0 265 005 765		
	12.08-04.10	103	Org.-Nr. 11683→			0 265 005 765		
		110	Org.-Nr. 11683→			0 265 005 765		
		128	Org.-Nr. 11683→			0 265 005 765		
	04.10-01.14	115/120				0 265 005 765		
	01.11-01.14	110				0 265 005 765		
1.6 VTi	12.09-01.14	88				0 265 005 765		
2.0	05.08-11.08	100-103	Org.-Nr. →11682, Get.-Nr. MC manual			0 265 005 715		
2.0 HDi			Org.-Nr. →11682, Get.-Nr. MC manual			0 265 005 765		
	12.08-01.14	100-103	Org.-Nr. 11683→			0 265 005 765		
2.0 HDi	09.09-01.14	110/120				0 265 005 765		
308 [T7]								
1.4	MFD 09.07-06.13	70/72				0 204 123 736	23,81	
1.4 VTi	OFD 09.07-06.13	70/72				0 204 123 737		
1.6, HDi, i Flex, THP, VTi	MFD 09.07→	66/68/80/82/84/85-90/103				0 204 123 736	23,81	
	OFD 09.07→	66/68/80/82/84/85-90/103/110/128				0 204 123 737		
1.6 GTi THP	05.10-06.13	147				0 204 718 072		
1.6 THP	04.10-06.13	115/120				0 204 123 736	23,81	
	01.11-06.13	110				0 204 123 736	23,81	
	MFD 09.07-04.10	110				0 204 123 736	23,81	
	03.08-04.10	128				0 204 123 736	23,81	
2.0	MFD 09.07-06.13	100-103				0 204 123 736	23,81	
2.0 HDi	OFD 09.07-06.13	100-103				0 204 123 737		
2.0 HDi	03.10-06.13	110/120				0 204 123 736	23,81	
1.4	MFD 09.07-06.13	70/72				0 204 125 902		
1.4 VTi	OFD 09.07-06.13	70/72				0 204 125 901		
1.6, HDi, THP, VTi	MFD 09.07-06.13	66/68/80/82/84/88/103				0 204 125 902		
	OFD 09.07-06.13	66/68/80/82/84/88/103/110/128				0 204 125 901		
1.6 GTi THP	05.10-06.13	147				0 204 718 070		
1.6 THP	04.10-06.13	115/120				0 204 125 902		
	01.11-06.13	110				0 204 125 902		
	MFD 09.07-04.10	110				0 204 125 902		
	03.08-04.10	128				0 204 125 902		



















PEUGEOT 308 [T7]

2.0	MFD	09.07-06.13	100-103		0 204 125 902	
2.0 HDi	OFD	09.07-06.13	100-103		0 204 125 901	
2.0 HDi		03.10-06.13	110/120		0 204 125 902	
	2.0 HDi	03.09-06.13	100-103	Org.-Nr. 11760 →	0 986 486 616	19
		03.10-06.13	110/120		0 986 486 616	19
	1.4	09.07-07.09	70	Org.-Nr. →11920	0 265 232 440 ^B	
		09.07-03.10	70		0 265 230 502 ^T	
	1.6	09.07-07.09	66/80/88/	Org.-Nr. →11920	0 265 232 440 ^B	
	1.6 HDi		103/110/			
	1.6 THP		128			
		09.07-06.13	66/80/88/103/		0 265 230 502 ^T	
			110/128			
	2.0	07.08-07.09	103	Org.-Nr. →11920	0 265 232 440 ^B	
		07.08-04.12	103		0 265 230 502 ^T	
	2.0 HDi	09.07-07.09	100-103	Org.-Nr. →11920	0 265 232 440 ^B	
	09.07-06.13	100-103		EU5 0 265 230 502 ^T		
	1.4	09.07-11.08	70	Org.-Nr. →11682, Get.-Nr. MC manual	0 265 005 715	
				Org.-Nr. →11682, Get.-Nr. MC manual	0 265 005 765	
		12.08-03.10	70	Org.-Nr. 11683 →	0 265 005 765	
	1.4 VTi	04.10-06.13	72		0 265 005 765	
	1.6	09.07-11.08	88	Org.-Nr. →11682, Get.-Nr. MC manual	0 265 005 715	
				Org.-Nr. →11682, Get.-Nr. MC manual	0 265 005 765	
		07.08-11.08	80	Org.-Nr. →11682, Get.-Nr. MC manual	0 265 005 765	
		12.08-04.12	80	Org.-Nr. 11683 →	0 265 005 765	
		12.08-06.13	88	Org.-Nr. 11683 →	0 265 005 765	
	1.6, HDi	09.07-11.08	80	Org.-Nr. →11682, Get.-Nr. MC manual	0 265 005 715	
	1.6 GTi THP	05.10-06.13	147		0 265 005 765	
	1.6 HDi	09.07-11.08	66	Org.-Nr. →11682, Get.-Nr. MC manual	0 265 005 715	
			80	Org.-Nr. →11682, Get.-Nr. MC manual	0 265 005 765	
		12.08-03.10	66	Org.-Nr. 11683 →	0 265 005 765	
			80	Org.-Nr. 11683 →	0 265 005 765	
		04.10-06.13	68		0 265 005 765	
			82/84		0 265 005 765	
		11.10-06.13	80		0 265 005 765	
	1.6 THP	09.07-11.08	110	Org.-Nr. →11682, Get.-Nr. MC manual	0 265 005 715	
				Org.-Nr. →11682, Get.-Nr. MC manual	0 265 005 765	
		11.07-11.08	103	Org.-Nr. →11682, Get.-Nr. MC manual	0 265 005 715	
				Org.-Nr. →11682, Get.-Nr. MC manual	0 265 005 765	
		03.08-11.08	128	Org.-Nr. →11682, Get.-Nr. MC manual	0 265 005 715	
				Org.-Nr. →11682, Get.-Nr. MC manual	0 265 005 765	
		12.08-04.10	103	Org.-Nr. 11683 →	0 265 005 765	
			110	Org.-Nr. 11683 →	0 265 005 765	
			128	Org.-Nr. 11683 →	0 265 005 765	
		04.10-06.13	115/120		0 265 005 765	
		01.11-06.13	110		0 265 005 765	
	1.6 VTi	12.09-06.13	88		0 265 005 765	
2.0	09.07-11.08	100-103	Org.-Nr. →11682, Get.-Nr. MC manual	0 265 005 715		
2.0 HDi			Org.-Nr. →11682, Get.-Nr. MC manual	0 265 005 765		
	12.08-06.13	100-103	Org.-Nr. 11683 →	0 265 005 765		
2.0 HDi	03.10-06.13	110/120		0 265 005 765		

405 Break [4]

	1.4	ABO	06.92-04.97	55		F 026 003 096	20,6
	1.4 i	ABS	06.92-04.97	55	JBH	F 026 003 142	22,2
	1.6	ABO	06.92-04.97	65-66/68		F 026 003 096	20,6
	1.6 i	ABS	06.92-04.97	65-66/68	JBH	F 026 003 142	22,2

		S							
1.8 i		ABO	06.92-04.97	74-76			F 026 003 096	20,6	
		ABS	06.92-04.97	74-76		JBH	F 026 003 142	22,2	
1.9, D, D Turbo, i		ABS	06.92-04.97	47/50/51-52/66-68/71/80/89		JBH	F 026 003 142	22,2	
1.9, i		ABO	06.92-04.97	71/80/89			F 026 003 096	20,6	
1.9 D, D Turbo		ABO	06.92-04.97	47/50/51-52/66-68		JBH	0 986 480 906	20	
2.0 i		ABO	06.92-04.97	89-91		JBH	0 986 480 906	20	
2.0 i 4x4		ABS	06.92-04.97	89-91		JBH	F 026 003 142	22,2	
 1.4, i		ABO	06.92-04.97	55			0 204 125 059		
1.6, i		ABO	06.92-04.97	65-66/68			0 204 125 059		
1.8 i		ABO	06.92-04.97	74-76			0 204 125 059		
1.9, i		ABO	06.92-04.97	71/80/89			0 204 125 059		
 1.4, i			06.92-04.97	55			0 986 482 005^A		
1.6, i			06.92-04.97	65-66/68			0 986 482 005^A		
1.8 i			06.92-04.97	74-76			0 986 482 005^A		
1.9, D, D Turbo, i			06.92-04.97	47/50/51-52/66-68/71/80/89			0 986 482 005^A		
2.0 i			06.92-04.97	89-91			0 986 482 005^A		
 1.4, i			06.92-04.97	55		BO	0 265 208 305^H		
1.6, i			06.92-04.97	65-66/68		BO	0 265 208 305^H		
1.8 i			06.92-04.97	74-76		BO	0 265 208 305^H		
1.9, D, D Turbo, i			06.92-04.97	47/50/51-52/66-68/71/80/89		BO	0 265 208 305^H		
2.0 i			06.92-04.97	89-91		BO	0 265 208 305^H		
2.0 i 4x4			06.92-04.97	89-91		BO	0 265 201 056^H		
 1.4			06.92-05.94	55		SHY,TEI	2 267 000 734^H		
1.4 i			06.92-04.97	55		SHX,TEI	2 267 000 732^H		
1.6			06.92-05.94	65-66/68		SHY,TEI	2 267 000 734^H		
1.6 i			06.92-04.97	65-66/68		SHX,TEI	2 267 000 732^H		
1.6 i			09.94-04.97	65		SHX,TEI	2 267 000 732^H		
1.8 i			06.92-05.94	74-76		SHY,TEI	2 267 000 734^H		
			06.92-04.97	74-76		SHX,TEI	2 267 000 732^H		
1.9, D, D Turbo, i			06.92-05.94	51-52/66-68/71/80/89		SHY,TEI	2 267 000 734^H		
			06.92-04.97	51-52/66-68/71/80/89		SHX,TEI	2 267 000 732^H		
1.9 D			06.92-05.94	47		SHY,TEI	2 267 000 734^H		
			06.92-06.94	47		SHX,TEI	2 267 000 732^H		
			07.94-04.97	50		SHX,TEI	2 267 000 732^H		
2.0 i			06.92-05.94	89-91		SHY,TEI	2 267 000 734^H		
			06.92-04.97	89-91		SHX,TEI	2 267 000 732^H		
2.0 i 4x4			06.92-04.97	89-91		BO	0 265 100 073^H		
 1.9 i			06.92-04.97	89			0 265 005 111		
2.0 i			06.92-04.97	89-91			0 265 005 111		
405 [4]									
									
 1.4		ABO	06.92-04.97	55			F 026 003 096	20,6	
1.4 i		ABS	06.92-04.97	55		JBH	F 026 003 142	22,2	
1.6		ABO	06.92-04.97	65-66/68			F 026 003 096	20,6	
1.6 i		ABS	06.92-04.97	65-66/68		JBH	F 026 003 142	22,2	
1.8 i		ABO	06.92-04.97	74-76			F 026 003 096	20,6	
		ABS	06.92-04.97	74-76		JBH	F 026 003 142	22,2	
1.9, D, D Turbo, i		ABS	06.92-04.97	47/50/51-52/66-68/71/80/89		JBH	F 026 003 142	22,2	
1.9, i		ABO	06.92-04.97	71/80/89			F 026 003 096	20,6	
1.9 D, D Turbo		ABO	06.92-04.97	47/50/51-52/66-68		JBH	0 986 480 906	20	
2.0 i T16 4x4			09.92-04.97	144-159			0 204 123 162	23,8	
2.0 i, i Mi16, i 4x4		ABO	06.92-04.97	89-91/110-118		JBH	0 986 480 906	20	
		ABS	06.92-04.97	89-91/110-118		JBH	F 026 003 142	22,2	





◀ PEUGEOT 405 [4]

	1.4, i	ABO	06.92-04.97	55		0 204 125 059	
	1.6, i	ABO	06.92-04.97	65-66/68		0 204 125 059	
	1.8 i	ABO	06.92-04.97	74-76		0 204 125 059	
	1.9, i	ABO	06.92-04.97	71/80/89		0 204 125 059	
	1.4, i		06.92-04.97	55		0 986 482 005 ^A	
	1.6, i		06.92-04.97	65-66/68		0 986 482 005 ^A	
	1.8 i		06.92-04.97	74-76		0 986 482 005 ^A	
	1.9, D, D Turbo, i		06.92-04.97	47/50/51-52/66-68/71/80/89		0 986 482 005 ^A	
	2.0 i, i Mi16		06.92-04.97	89-91/110-118		0 986 482 005 ^A	
	1.4, i		06.92-04.97	55	BO	0 265 208 305 ^H	
	1.6, i		06.92-04.97	65-66/68	BO	0 265 208 305 ^H	
	1.8 i		06.92-04.97	74-76	BO	0 265 208 305 ^H	
	1.9, D, D Turbo, i		06.92-04.97	47/50/51-52/66-68/71/80/89	BO	0 265 208 305 ^H	
	2.0 i		06.92-04.97	89-91	BO	0 265 208 305 ^H	
	2.0 i Mi16		01.93-04.97	110-118	BO	0 265 208 305 ^H	
	2.0 i T16 4x4		09.92-04.97	144-159	BO	0 265 201 056 ^H	
	2.0 i 4x4		06.92-04.97	89-91	BO	0 265 201 056 ^H	
	1.4		06.92-05.94	55	SHY,TEI	2 267 000 734 ^H	
	1.4 i		06.92-04.97	55	SHX,TEI	2 267 000 732 ^H	
	1.6		06.92-05.94	65-66/68	SHY,TEI	2 267 000 734 ^H	
	1.6 i		06.92-04.97	65-66/68	SHX,TEI	2 267 000 732 ^H	
	1.8 i		06.92-05.94	74-76	SHY,TEI	2 267 000 734 ^H	
			06.92-04.97	74-76	SHX,TEI	2 267 000 732 ^H	
	1.9, D, D Turbo, i		06.92-05.94	51-52/66-68/71/80/89	SHY,TEI	2 267 000 734 ^H	
			06.92-04.97	51-52/66-68/71/80/89	SHX,TEI	2 267 000 732 ^H	
	1.9 D		06.92-05.94	47	SHY,TEI	2 267 000 734 ^H	
			06.92-06.94	47	SHX,TEI	2 267 000 732 ^H	
			07.94-04.97	50	SHX,TEI	2 267 000 732 ^H	
	2.0 i		06.92-05.94	89-91	SHY,TEI	2 267 000 734 ^H	
			06.92-04.97	89-91	SHX,TEI	2 267 000 732 ^H	
	2.0 i Mi16		01.93-05.94	110-118	SHY,TEI	2 267 000 734 ^H	
			01.93-04.97	110-118	SHX,TEI	2 267 000 732 ^H	
2.0 i T16 4x4		09.92-04.97	144-159	BO	0 265 100 073 ^H		
2.0 i 4x4		06.92-04.97	89-91	BO	0 265 100 073 ^H		
	1.9 i		06.92-04.97	89		0 265 005 111	
	2.0 i, i Mi16, i T16 4x4, i 4x4		06.92-04.97	89-91/110-118/ 144-159		0 265 005 111	

405 [15]



	1.6	ABO	08.92-05.97	80		F 026 003 096	20,6
		ABS	08.92-05.97	80	JBH	F 026 003 142	22,2
	1.6	ABO	08.92-05.97	80		0 204 125 059	
	1.6		08.92-05.97	80		0 986 482 005 ^A	
	1.6		08.92-05.97	80		0 265 208 305 ^H	
	1.6		08.92-05.97	80		0 273 004 088 ^H	



406 Break [D8]

Engine	Year	Model	Code	Part	Price	Notes	
	1.8 i	ABO 10.96-03.99	66/74-76/			0 204 124 073 ⁶	
	1.8 i 16V		81-82	JBH	F 026 003 190	23,8	
		ABS 10.96-01.99	66/74-76/81-82	JBH	F 026 003 192	23,8	
	1.9 D Turbo	ABO 10.96-03.99	55/66-68				0 204 124 073 ⁶
				JBH	F 026 003 190	23,8	
		ABS 10.96-01.99	55/66-68	JBH	F 026 003 192	23,8	
	2.0 HDi	10.98-03.99	80		F 026 003 511	23,81	
	2.0 i Turbo	ABS 10.96-01.99	104-110	JBH	F 026 003 192	23,8	
	2.0 i Turbo	ABO 10.96-03.99	97-99/				0 204 124 073 ⁶
	2.0 i 16V		104-110	JBH	F 026 003 190	23,8	
	2.0 i 16V	ABS 10.96-03.99	97-99	JBH	F 026 003 192	23,8	
	2.1 D Turbo	ABO 10.96-03.99	80-81				0 204 124 073 ⁶
				JBH	F 026 003 190	23,8	
		ABS 10.96-03.99	80-81	JBH	F 026 003 192	23,8	
	3.0 i	ABO 10.96-03.99	140-143				0 204 124 073 ⁶
			JBH	F 026 003 190	23,8		
	ABS 10.96-03.99	140-143	JBH	F 026 003 192	23,8		
	1.8 i	10.96-03.99	66/74-76/	LLE	0 204 125 139		
	1.8 i 16V		81-82	RLE	0 204 125 141		
	1.9 D Turbo	10.96-03.99	55/66-68				
				LLE	0 204 125 139		
				RLE	0 204 125 141		
	2.0 HDi	10.96-03.99	80/97-99	LLE	0 204 125 139		
	2.0 i 16V			RLE	0 204 125 141		
	2.0 i Turbo	10.96-03.99	104-110				
				LLE	0 204 125 145		
				RLE	0 204 125 143		
	2.1 D Turbo	10.96-03.99	80-81				
				LLE	0 204 125 139		
				RLE	0 204 125 141		
	3.0 i	10.96-03.99	140-143				
				LLE	0 204 125 145		
			RLE	0 204 125 143			
	1.8 i	09.97-06.98	66	Org.-Nr. 7511→		0 265 216 482 ^B	
		07.98-03.99	66		BKR	0 265 216 641 ^B	
	1.8 i	10.96-06.97	74-76/	Org.-Nr. →7510			0 265 216 303 ^H
		1.8 i 16V		81-82			
		07.97-06.98	74-76/	Org.-Nr. 7511→			0 265 216 482 ^B
			81-82				
		07.98-03.99	74-76/81-82		BKR	0 265 216 641 ^B	
	1.9 D Turbo	10.96-06.97	55/66-68	Org.-Nr. →7510			0 265 216 303 ^H
		07.97-06.98	55/66-68	Org.-Nr. 7511→			0 265 216 482 ^B
		07.98-03.99	55/66-68		BKR	0 265 216 641 ^B	
	2.0 HDi	10.98-03.99	80			0 265 216 641 ^B	
	2.0 i Turbo	10.96-06.97	97-99/	Org.-Nr. →7510			0 265 216 303 ^H
	2.0 i 16V		104-110				
		07.97-06.98	97-99/	Org.-Nr. 7511→			0 265 216 482 ^B
			104-110				
	07.98-03.99	97-99/104-110				0 265 216 641 ^B	
2.1 D Turbo	10.96-06.97	80-81	Org.-Nr. →7510			0 265 216 303 ^H	
	07.97-06.98	80-81	Org.-Nr. 7511→			0 265 216 482 ^B	
	07.98-03.99	80-81				0 265 216 641 ^B	
3.0 i	10.96-06.97	140-143	Org.-Nr. →7510			0 265 216 303 ^H	
	07.97-06.98	140-143	Org.-Nr. 7511→			0 265 216 482 ^B	
	07.98-03.99	140-143				0 265 216 641 ^B	
	1.8 i, i 16V	10.96-06.97	74-76/	Org.-Nr. →7510		0 273 004 093 ^H	
			81-82				
	OAS 10.96-06.97	74-76/	Org.-Nr. →7510	TEI	1 267 000 820 ^H		
		81-82					





PEUGEOT 406 Break [D8]

1.9 D Turbo	10.96-06.97	55/66-68	Org.-Nr. →7510		0 273 004 093^H
	OAS 10.96-06.97	55/66-68	Org.-Nr. →7510	TEI	1 267 000 820^H
2.0 i Turbo	10.96-06.97	97-99/	Org.-Nr. →7510		0 273 004 093^H
		104-110			
2.0 i 16V	10.96-06.97	97-99/	Org.-Nr. →7510	TEI	1 267 000 820^H
		104-110			
2.1 D Turbo	10.96-06.97	80-81	Org.-Nr. →7510		0 273 004 093^H
	OAS 10.96-06.97	80-81	Org.-Nr. →7510	TEI	1 267 000 820^H
3.0 i	10.96-06.97	140-143	Org.-Nr. →7510		0 273 004 093^H
	OAS 10.96-06.97	140-143	Org.-Nr. →7510	TEI	1 267 000 820^H

406 Break [D9]



1.8 i	ABO 04.99-06.04	66/74-76/81/85		JBH BO	F 026 003 512	23,81
	ABS 04.99-06.04	66/74-76/81/85			BO F 026 003 511	23,81
	OFD 04.99-06.04	66/74-76/81/85		JBH ATE	F 026 003 942	23,81
2.0 HDi, HPI, i 16V	ABO 04.99-06.04	66/79/80/97/99/100/103		JBH BO	F 026 003 512	23,81
	ABS 04.99-06.04	66/79/80/97/99/100/103			BO F 026 003 511	23,81
	OFD 04.99-06.04	66/79/80/97/99/100/103		JBH ATE	F 026 003 942	23,81
2.2 HDi	ABO 04.99-06.04	98/116		JBH BO	F 026 003 512	23,81
	ABS 04.99-06.04	98/116			BO F 026 003 511	23,81
2.2 i 16V	04.99-06.04	98/116		JBH ATE	F 026 003 942	23,81
	OFD 04.99-06.04	98/116			ATE F 026 003 942	23,81
3.0 i	ABO 04.99-06.04	140/150		JBH BO	F 026 003 512	23,81
	ABS 04.99-06.04	140/150			BO F 026 003 511	23,81
	OFD 04.99-06.04	140/150		JBH ATE	F 026 003 942	23,81

1.8 i	04.99-06.04	66/74-76/		LLE BO	0 204 125 139
		81		RLE BO	0 204 125 141
2.0 HDi	04.99-06.04	66/79/80/		LLE BO	0 204 125 139
		97/99/100		RLE BO	0 204 125 141
2.2 i 16V	04.99-06.04	116		LLE BO	0 204 125 145
				RLE BO	0 204 125 143
3.0 i	04.99-06.04	140/150		LLE BO	0 204 125 145
				RLE BO	0 204 125 143

1.8 i	04.99-06.04	66/74-76/			0 265 202 419^M
		81/85			0 265 216 544^B
2.0 HDi, HPI, i 16V	04.99-06.04	66/79/80/97/			0 265 202 419^M
		99/100/103			0 265 216 544^B
2.2 HDi	04.99-06.04	98/116			0 265 202 419^M
2.2 i 16V					0 265 216 544^B
3.0 i	04.99-06.04	140/150			0 265 202 419^M
					0 265 216 544^B



1.8 i, i 16V	04.99-06.04	66/74-76/81/85			0 265 109 089^M
2.0 HDi, HPI, i 16V	04.99-06.04	66/79/80/97/99/100/103			0 265 109 089^M
2.2 HDi, i 16V	04.99-06.04	98/116			0 265 109 089^M
3.0 i	04.99-06.04	140/150			0 265 109 089^M



1.8 i, i 16V	04.99-09.01	66/74-76/	Org.-Nr. →9064		0 265 005 290
	10.01-06.04	66/74-76/	Org.-Nr. 9065→		0 265 005 253
2.0 HDi	04.99-09.01	66/79/80/	Org.-Nr. →9064		0 265 005 290
		97			
2.0 i 16V	10.01-06.04	66/79/80/	Org.-Nr. 9065→		0 265 005 253
		97			
2.0 HPI	10.00-09.01	100/103	Org.-Nr. →9064		0 265 005 290
2.0 i 16V	10.01-06.04	100/103	Org.-Nr. 9065→		0 265 005 253
2.0 i 16V	04.99-10.00	99			0 265 005 290
2.2 HDi	04.99-09.01	98/116	Org.-Nr. →9064		0 265 005 290
2.2 i 16V	10.01-06.04	98/116	Org.-Nr. 9065→		0 265 005 253

		S							
	3.0i	04.99-09.01	140/150	Org.-Nr. →9064			0 265 005 290		
		10.01-06.04	140/150	Org.-Nr. 9065→			0 265 005 253		
	1.8i, i 16V	04.99-06.04	66/74-76/81/85				0 265 005 404		
	2.0 HDi, HPI, i 16V	04.99-06.04	66/79/80/97/99/100/103				0 265 005 404		
	2.2 HDi, i 16V	04.99-06.04	98/116				0 265 005 404		
	3.0i	04.99-06.04	140/150				0 265 005 404		
406 Coupé [D8]									
	1.8i 16V	ABO 09.97-03.99	81						0 204 124 073 ⁶
		ABS 09.97-01.99	81		JBH	F 026 003 190	23,8		
	2.0i 16V	ABO 03.97-03.99	97-99						0 204 124 073 ⁶
		ABS 03.97-03.99	97-99		JBH	F 026 003 190	23,8		
	3.0i	ABO 03.97-03.99	140-143						0 204 124 073 ⁶
		ABS 03.97-03.99	140-143		JBH	F 026 003 190	23,8		
					JBH	F 026 003 192	23,8		
	1.8i 16V	09.97-03.99	81		LLE	0 204 125 139			
					RLE	0 204 125 141			
	2.0i 16V	03.97-03.99	97-99		LLE	0 204 125 139			
					RLE	0 204 125 141			
	3.0i	03.97-03.99	140-143		LLE	0 204 125 145			
					RLE	0 204 125 143			
	1.8i 16V	09.97-06.98	81	Org.-Nr. 7511→			0 265 216 482 ^B		
		07.98-03.99	81				0 265 216 641 ^B		
	2.0i 16V	03.97-06.97	97-99	Org.-Nr. →7510			0 265 216 303 ^H		
		07.97-06.98	97-99	Org.-Nr. 7511→			0 265 216 482 ^B		
		07.98-03.99	97-99				0 265 216 641 ^B		
	3.0i	03.97-06.97	140-143	Org.-Nr. →7510			0 265 216 303 ^H		
		07.97-06.98	140-143	Org.-Nr. 7511→			0 265 216 482 ^B		
		07.98-03.99	140-143				0 265 216 641 ^B		
	2.0i 16V	03.97-06.97	97-99	Org.-Nr. →7510			0 273 004 093 ^H		
		OAS 03.97-06.97	97-99	Org.-Nr. →7510	TEI		1 267 000 820 ^H		
	3.0i	03.97-06.97	140-143	Org.-Nr. →7510			0 273 004 093 ^H		
		OAS 03.97-06.97	140-143	Org.-Nr. →7510	TEI		1 267 000 820 ^H		
406 Coupé [D9]									
	2.0i 16V	ABO 04.99-02.05	97-99/100		JBH	BO	F 026 003 512	23,81	
		ABS 04.99-02.05	97-99/100			BO	F 026 003 511	23,81	
		OFD 04.99-02.05	97-99/100		JBH	ATE	F 026 003 942	23,81	
	2.2 HDi	ABO 03.00-02.05	98/116		JBH	BO	F 026 003 512	23,81	
	2.2i 16V	ABS 03.00-02.05	98/116			BO	F 026 003 511	23,81	
		OFD 03.00-02.05	98/116		JBH	ATE	F 026 003 942	23,81	
	3.0i	ABO 04.99-02.05	140/150		JBH	BO	F 026 003 512	23,81	
		ABS 04.99-02.05	140/150			BO	F 026 003 511	23,81	
		OFD 04.99-02.05	140/150		JBH	ATE	F 026 003 942	23,81	
	2.0i 16V	04.99-02.05	97-99/100		LLE	BO	0 204 125 139		
					RLE	BO	0 204 125 141		
	2.2i 16V	03.02-02.05	116		LLE	BO	0 204 125 145		
					RLE	BO	0 204 125 143		
	3.0i	04.99-02.05	140/150		LLE	BO	0 204 125 145		
					RLE	BO	0 204 125 143		





◀ PEUGEOT 406 Coupé [D9]

	2.0 i 16V	04.99-02.05	97-99/100		0 265 202 419 ^M	
					0 265 216 544 ^B	
	2.2 HDi	03.00-02.05	98/116		0 265 202 419 ^M	
	2.2 i 16V				0 265 216 544 ^B	
	3.0 i	04.99-02.05	140/150		0 265 202 419 ^M	
					0 265 216 544 ^B	
	2.0 i 16V	04.99-02.05	97-99/100		0 265 109 089 ^M	
	2.2 HDi, i 16V	03.00-02.05	98/116		0 265 109 089 ^M	
	3.0 i	04.99-02.05	140/150		0 265 109 089 ^M	
	2.0 i 16V	04.99-10.00	99		0 265 005 290	
		04.99-09.01	97-99	Org.-Nr. →9064	0 265 005 290	
		10.00-09.01	100	Org.-Nr. →9064	0 265 005 290	
		10.01-02.05	97-99	Org.-Nr. 9065→	0 265 005 253	
			100	Org.-Nr. 9065→	0 265 005 253	
	2.2 HDi	03.00-09.01	98	Org.-Nr. →9064	0 265 005 290	
		10.01-02.05	98	Org.-Nr. 9065→	0 265 005 253	
	2.2 i 16V	03.02-02.05	116		0 265 005 253	
	3.0 i	04.99-09.01	140/150	Org.-Nr. →9064	0 265 005 290	
		10.01-02.05	140/150	Org.-Nr. 9065→	0 265 005 253	
	2.0 i 16V	04.99-02.05	97-99/100		0 265 005 404	
	2.2 HDi, i 16V	03.00-02.05	98/116		0 265 005 404	
	3.0 i	04.99-02.05	140/150		0 265 005 404	

406 [D8]

	1.6 i	ABO	10.95-03.99	65			0 204 124 073 ⁶	
		ABS	10.95-01.99	65	JBH	F 026 003 190	23,8	
					JBH	F 026 003 192	23,8	
	1.8 i	ABO	10.95-03.99	66/74-76/			0 204 124 073 ⁶	
				81-82	JBH	F 026 003 190	23,8	
	1.8 i 16V	ABS	10.95-01.99	66/74-76/	JBH	F 026 003 192	23,8	
				81-82				
1.9 D Turbo	ABO	12.95-03.99	55/66-68				0 204 124 073 ⁶	
	ABS	12.95-01.99	55/66-68	JBH	F 026 003 190	23,8		
				JBH	F 026 003 192	23,8		
2.0 HDi			10.98-03.99	80		F 026 003 511	23,81	
2.0 i Turbo	ABO	10.95-03.99	97-99/				0 204 124 073 ⁶	
2.0 i 16V				104-110	JBH	F 026 003 190	23,8	
	ABS	10.95-01.99	97-99/104-110	JBH	F 026 003 192	23,8		
2.1 D Turbo	ABO	12.95-03.99	80-81				0 204 124 073 ⁶	
	ABS	12.95-01.99	80-81	JBH	F 026 003 190	23,8		
				JBH	F 026 003 192	23,8		
3.0 i	ABO	08.96-03.99	140-143				0 204 124 073 ⁶	
	ABS	08.96-01.99	140-143	JBH	F 026 003 190	23,8		
				JBH	F 026 003 192	23,8		
	1.6 i		10.95-03.99	65	LLE	0 204 125 139		
					RLE	0 204 125 141		
	1.8 i		10.95-03.99	66/74-76/	LLE	0 204 125 139		
				81-82	RLE	0 204 125 141		
	1.9 D Turbo		12.95-03.99	55/66-68	LLE	0 204 125 139		
					RLE	0 204 125 141		
	2.0 HDi		10.95-03.99	80/97-99	LLE	0 204 125 139		
	2.0 i 16V				RLE	0 204 125 141		
					LLE	0 204 125 145		
	2.0 i Turbo		04.96-03.99	104-110	RLE	0 204 125 143		
					LLE	0 204 125 139		
	2.1 D Turbo		12.95-03.99	80-81	RLE	0 204 125 141		
				LLE	0 204 125 139			

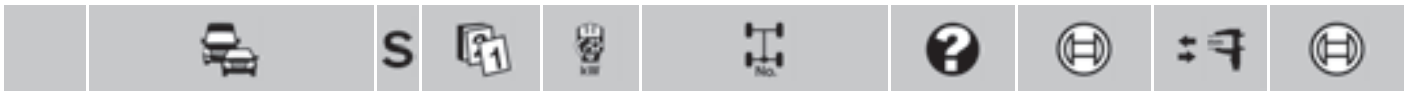

	3.0i	08.96-03.99	140-143		LLE	0 204 125 145	
					RLE	0 204 125 143	
	1.6i	10.95-06.97	65	Org.-Nr. →7510		0 265 216 303 ^H	
		07.97-06.98	65	Org.-Nr. 7511→		0 265 216 482 ^B	
		07.98-03.99	65		BKR	0 265 216 641 ^B	
	1.8i	09.97-06.98	66	Org.-Nr. 7511→		0 265 216 482 ^B	
		07.98-03.99	66		BKR	0 265 216 641 ^B	
	1.8i	10.95-06.97	74-76/	Org.-Nr. →7510		0 265 216 303 ^H	
	1.8i 16V		81-82				
		07.97-06.98	74-76/	Org.-Nr. 7511→		0 265 216 482 ^B	
			81-82				
		07.98-03.99	74-76/81-82		BKR	0 265 216 641 ^B	
	1.9D Turbo	12.95-06.97	55/66-68	Org.-Nr. →7510		0 265 216 303 ^H	
		07.97-06.98	55/66-68	Org.-Nr. 7511→		0 265 216 482 ^B	
		07.98-03.99	55/66-68		BKR	0 265 216 641 ^B	
	2.0 HDi	10.98-03.99	80			0 265 216 641 ^B	
	2.0i Turbo	10.95-06.97	97-99/	Org.-Nr. →7510		0 265 216 303 ^H	
	2.0i 16V		104-110				
		07.97-06.98	97-99/	Org.-Nr. 7511→		0 265 216 482 ^B	
			104-110				
		07.98-03.99	97-99/104-110			0 265 216 641 ^B	
	2.1D Turbo	12.95-06.97	80-81	Org.-Nr. →7510		0 265 216 303 ^H	
		07.97-06.98	80-81	Org.-Nr. 7511→		0 265 216 482 ^B	
		07.98-03.99	80-81			0 265 216 641 ^B	
	3.0i	08.96-06.97	140-143	Org.-Nr. →7510		0 265 216 303 ^H	
		07.97-06.98	140-143	Org.-Nr. 7511→		0 265 216 482 ^B	
		07.98-03.99	140-143			0 265 216 641 ^B	

	1.6i	10.95-06.97	65	Org.-Nr. →7510		0 273 004 093 ^H	
		OAS 10.95-06.97	65	Org.-Nr. →7510	TEI	1 267 000 820 ^H	
	1.8i	10.95-06.97	74-76/	Org.-Nr. →7510		0 273 004 093 ^H	
	1.8i 16V		81-82				
		OAS 10.95-06.97	74-76/	Org.-Nr. →7510	TEI	1 267 000 820 ^H	
			81-82				
	1.9D Turbo	12.95-06.97	55/66-68	Org.-Nr. →7510		0 273 004 093 ^H	
		OAS 12.95-06.97	55/66-68	Org.-Nr. →7510	TEI	1 267 000 820 ^H	
	2.0i Turbo	10.95-06.97	97-99/	Org.-Nr. →7510		0 273 004 093 ^H	
			104-110				
	2.0i 16V	OAS 10.95-06.97	97-99/	Org.-Nr. →7510	TEI	1 267 000 820 ^H	
			104-110				
	2.1D Turbo	12.95-06.97	80-81	Org.-Nr. →7510		0 273 004 093 ^H	
		OAS 12.95-06.97	80-81	Org.-Nr. →7510	TEI	1 267 000 820 ^H	
	3.0i	08.96-06.97	140-143	Org.-Nr. →7510		0 273 004 093 ^H	
		OAS 08.96-06.97	140-143	Org.-Nr. →7510	TEI	1 267 000 820 ^H	

406 [D9]

	1.6i	ABO 04.99-06.04	65		JBH	BO	F 026 003 512	23,81
		ABS 04.99-06.04	65			BO	F 026 003 511	23,81
		OFD 04.99-06.04	65		JBH	ATE	F 026 003 942	23,81
	1.8i	ABO 04.99-06.04	66/74-76/81-82/85		JBH	BO	F 026 003 512	23,81
	1.8i 16V	ABS 04.99-06.04	66/74-76/81-82/85			BO	F 026 003 511	23,81
		OFD 04.99-06.04	66/74-76/81-82/85		JBH	ATE	F 026 003 942	23,81
	2.0 HDi, HPI, i 16V	OFD 04.99-06.04	66/79/80/97/99/103		JBH	ATE	F 026 003 942	23,81
	2.0 HDi	ABO 04.99-06.04	66/79/80/97/99		JBH	BO	F 026 003 512	23,81
	2.0i 16V	ABS 04.99-06.04	66/79/80/97/99			BO	F 026 003 511	23,81
	2.0 HPi	ABO 10.00-06.04	103		JBH	BO	F 026 003 512	23,81
		ABS 10.00-06.04	103			BO	F 026 003 511	23,81
	2.0i 16V	ABO 08.00-06.04	100		JBH		F 026 003 512	23,81
		ABS 08.00-06.04	100			BO	F 026 003 511	23,81
					JBH	ATE	F 026 003 942	23,81





	◀ PEUGEOT 406 [D9]							
2.2 HDi	ABO	04.99-06.04	98/116		JBH	BO	F 026 003 512	23,81
2.2 i 16V	ABS	04.99-06.04	98/116			BO	F 026 003 511	23,81
	OFD	04.99-06.04	98/116		JBH	ATE	F 026 003 942	23,81
3.0 i	ABO	04.99-06.04	140-143/150		JBH	BO	F 026 003 512	23,81
	ABS	04.99-06.04	140-143/150			BO	F 026 003 511	23,81
	OFD	04.99-06.04	140-143/150		JBH	ATE	F 026 003 942	23,81





















	1.6 i	04.99-06.04	65	LLE	BO	0 204 125 139	
				RLE	BO	0 204 125 141	
1.8 i	04.99-06.04	66/74-76/	81-82	LLE	BO	0 204 125 139	
				RLE	BO	0 204 125 141	
1.8 i 16V	04.99-06.04	66/79/80/	97/99/100	LLE	BO	0 204 125 139	
				RLE	BO	0 204 125 141	
2.0 HDi	04.99-06.04	66/79/80/	116	LLE	BO	0 204 125 145	
				RLE	BO	0 204 125 143	
2.0 i 16V	04.99-06.04	116		LLE	BO	0 204 125 145	
				RLE	BO	0 204 125 143	
2.2 i 16V	04.99-06.04	116		LLE	BO	0 204 125 145	
				RLE	BO	0 204 125 143	
3.0 i	04.99-06.04	140-143/	150	LLE	BO	0 204 125 145	
				RLE	BO	0 204 125 143	

	1.6 i	04.99-06.04	65			0 265 202 419 ^M					
						0 265 216 544 ^B					
				1.8 i	04.99-06.04	66/74-76/	81-82/85			0 265 202 419 ^M	
										0 265 216 544 ^B	
				1.8 i 16V	04.99-06.04	66/79/80/	97/99			0 265 202 419 ^M	
										0 265 216 544 ^B	
				2.0 HDi	04.99-06.04	66/79/80/	103			0 265 202 419 ^M	
										0 265 216 544 ^B	
				2.0 i 16V	10.00-06.04	103				0 265 202 419 ^M	
										0 265 216 544 ^B	
				2.0 i 16V	08.00-06.04	100				0 265 202 419 ^M	
									TW	0 265 216 544 ^B	
				2.2 HDi	04.99-06.04	98/116				0 265 202 419 ^M	
										0 265 216 544 ^B	
				2.2 i 16V	04.99-06.04	140-143/	150			0 265 202 419 ^M	
		0 265 216 544 ^B									

	1.6 i	04.99-06.04	65			0 265 109 089 ^M	
	1.8 i, i 16V	04.99-06.04	66/74-76/81-82/85			0 265 109 089 ^M	
	2.0 HDi, HPI, i 16V	04.99-06.04	66/79/80/97/99/100/103			0 265 109 089 ^M	
	2.2 HDi, i 16V	04.99-06.04	98/116			0 265 109 089 ^M	
	3.0 i	04.99-06.04	140-143/150			0 265 109 089 ^M	

	1.6 i	04.99-09.01	65	Org.-Nr. →9064		0 265 005 290		
				10.01-06.04	65	Org.-Nr. 9065→	0 265 005 253	
	1.8 i	04.99-09.01	66/74-76/	81-82/85	Org.-Nr. →9064		0 265 005 290	
					10.01-06.04	66/74-76/	81-82/85	Org.-Nr. 9065→
	2.0 HDi	04.99-09.01	66/79/80/	97	Org.-Nr. →9064		0 265 005 290	
					10.01-06.04	66/79/80/	97	Org.-Nr. 9065→
	2.0 i 16V	08.00-09.01	100/103		Org.-Nr. →9064		0 265 005 290	
					10.01-06.04	100/103		Org.-Nr. 9065→
	2.0 i 16V	04.99-08.00	99				0 265 005 290	
							0 265 005 290	
	2.2 HDi	04.99-09.01	98/116		Org.-Nr. →9064		0 265 005 290	
					10.01-06.04	98/116		Org.-Nr. 9065→
	2.2 i 16V	04.99-09.01	140-143/	150	Org.-Nr. →9064		0 265 005 290	
					10.01-06.04	140-143/	150	Org.-Nr. 9065→

	1.6 i	04.99-06.04	65			0 265 005 404	
	1.8 i, i 16V	04.99-06.04	66/74-76/81-82/85			0 265 005 404	
	2.0 HDi, HPI, i 16V	04.99-06.04	66/79/80/97/99/100/103			0 265 005 404	

		S							
		2.2 HDi, i 16V	04.99-06.04	98/116			0 265 005 404		
		3.0i	04.99-06.04	140-143/150			0 265 005 404		
407 Coupé [D2]									
									
		2.0 HDi, HDi 16V	07.07-12.11	100-110/120			0 986 486 616	19	
		2.2	06.07-06.09	120	Org.-Nr. 11130→		0 986 486 616	19	
		2.0 HDi	08.07-06.09	100-103	Org.-Nr. 11193→		0 265 005 765		
		2.0 HDi 16V	07.09-12.11	100-110/120			0 265 005 765		
		2.2	11.07-06.09	120	Org.-Nr. 11284→		0 265 005 765		
		2.7 HDi	11.07-06.09	150	Org.-Nr. 11284→		0 265 005 765		
		3.0	11.07-06.09	155	Org.-Nr. 11284→		0 265 005 765		
		3.0 HDi 24V	07.09-12.11	177			0 265 005 765		
407 [D2]									
									
		1.6 HDi	06.07-02.11	80	Org.-Nr. 11130→		0 986 486 616	19	
		1.8	06.07-02.11	92	Org.-Nr. 11130→		0 986 486 616	19	
		2.0, HDi	06.07-02.11	100-103	Org.-Nr. 11130→		0 986 486 616	19	
		2.0 HDi	11.09-02.11	110/120			0 986 486 616	19	
		2.2	06.07-06.09	120	Org.-Nr. 11130→		0 986 486 616	19	
		1.6 HDi	05.07-02.11	80	Org.-Nr. 11102→		0 265 005 765		
		1.8	05.07-02.11	92	Org.-Nr. 11102→		0 265 005 765		
		2.0, HDi	05.07-02.11	100-103	Org.-Nr. 11102→		0 265 005 765		
		2.0 HDi	11.09-02.11	110/120			0 265 005 765		
		2.2, HDi	05.07-07.10	120-125	Org.-Nr. 11102→		0 265 005 765		
		2.7 HDi	05.07-06.09	150	Org.-Nr. 11102→		0 265 005 765		
407 SW [D2]									
									
		1.6 HDi	06.07-02.11	80	Org.-Nr. 11130→		0 986 486 616	19	
		1.8	06.07-02.11	92	Org.-Nr. 11130→		0 986 486 616	19	
		2.0, HDi	06.07-02.11	100-103	Org.-Nr. 11130→		0 986 486 616	19	
		2.0 HDi	11.09-02.11	110/120			0 986 486 616	19	
		2.2	06.07-06.09	120	Org.-Nr. 11130→		0 986 486 616	19	
		1.6 HDi	05.07-02.11	80	Org.-Nr. 11102→		0 265 005 765		
		1.8	05.07-02.11	92	Org.-Nr. 11102→		0 265 005 765		
		2.0, HDi	05.07-02.11	100-103	Org.-Nr. 11102→		0 265 005 765		
		2.0 HDi	11.09-02.11	110/120			0 265 005 765		
		2.2, HDi	05.07-07.10	120-125	Org.-Nr. 11102→		0 265 005 765		
		2.7 HDi	05.07-06.09	150	Org.-Nr. 11102→		0 265 005 765		
508 RXH SW [W2]									
									
		2.0 HDi HYbrid4 4x4	09.11→	120-147			0 265 005 765		
508 SW [W2]									
									
		1.6 BlueHdi, HDi, THP, VTi	10.10→	82/84/85/88/110/115/120/121			0 265 005 765		
		2.0 Blue HDi, HDi	10.10→	100-103/110/120/132			0 265 005 765		
		2.2 HDi	10.10→	150			0 265 005 765		





◀ PEUGEOT

508 [W2]



	1.6 BlueHdi, HDi, i THP, THP, VTi	10.10→	82/84/85/88/110/115/120/121			0 265 005 765	
	2.0 Blue HDi, HDi, HDi HYbrid4 4x4	10.10→	100-103/110/120-147			0 265 005 765	
	2.2 HDi	10.10→	150			0 265 005 765	

605 [Y30]



	2.0	ABO 06.89-05.99	79-81/84/89-90/94	JBH	BSY	F 026 003 188	22,2
	2.0 i	ABS 06.89-05.99	79-81/84/89-90/94	JBH	BSY	F 026 003 518	22,2
	2.0 i Turbo	ABO 07.92-05.99	104-110	JBH	BSY	F 026 003 188	22,2
		ABS 07.94-05.99	104-110	JBH	ATE	0 986 480 912	23
					BSY	F 026 003 518	22,2
	2.0 i Turbo, i 16V	ABS 07.92-11.97	97-99/104	JBH	BSY	F 026 003 518	22,2
	2.0 i 16V	12.97-05.99	97-99 Org.-Nr. 7693→	JBH	BSY	F 026 003 518	22,2
		ABO 07.94-11.97	97-99 Org.-Nr. →7692	JBH	BSY	F 026 003 188	22,2
	2.1 D	ABO 06.89-05.99	60-61/80-81	JBH	BSY	F 026 003 188	22,2
	2.1 D Turbo	ABS 06.89-05.99	60-61/80-81	JBH	BSY	F 026 003 518	22,2
	2.5 D Turbo	ABS 07.94-05.99	94-96	JBH	ATE	0 986 480 912	23
	3.0 i	ABO 07.93-05.99	123-125	JBH	BSY	F 026 003 188	22,2
	3.0 i, i 24V	ABS 07.93-05.99	123-125/140-143/147	JBH	ATE	0 986 480 912	23

	2.0, i, i Turbo, i 16V	06.89-05.99	79-81/84/89-90/94/97-99/104-110	LLE	BSY	0 204 125 084	
	2.1 D, D Turbo	06.89-05.99	60-61/80-81	LLE	BSY	0 204 125 084	
	3.0 i	07.93-05.99	123-125	LLE	BSY	0 204 125 084	

	2.0	10.89-06.96	79 Org.-Nr. →7146		BO	0 265 201 058^H	
		07.96-12.97	79 Org.-Nr. 7147→7692		BO	0 265 216 341^H	
		01.98-05.99	79 Org.-Nr. 7693→		BO	0 265 216 482^B	
	2.0	06.89-06.94	79-81/84/89-90 Org.-Nr. →7146		BO	0 265 201 058^H	
		2.0 i Turbo	07.92-06.94	104 Org.-Nr. →7146		BO	0 265 201 058^H
	07.94-06.96		104-110 Org.-Nr. →7146		BO	0 265 201 058^H	
	07.96-12.97		104-110 Org.-Nr. 7147→7692		BO	0 265 216 341^H	
	01.98-05.99		104-110 Org.-Nr. 7693→		BO	0 265 216 482^B	
	2.0 i		10.89-06.96	94/97-99 Org.-Nr. →7146		BO	0 265 201 058^H
		2.0 i 16V	07.96-12.97	94/97-99 Org.-Nr. 7147→7692		BO	0 265 216 341^H
	01.98-05.99		94/97-99 Org.-Nr. 7693→		BO	0 265 216 482^B	
	2.1 D		06.89-06.94	60-61 Org.-Nr. →7146		BO	0 265 201 058^H
		2.1 D Turbo	06.89-06.96	80-81 Org.-Nr. →7146		BO	0 265 201 058^H
	07.96-12.97		80-81 Org.-Nr. 7147→7692		BO	0 265 216 341^H	
	01.98-05.99		80-81 Org.-Nr. 7693→		BO	0 265 216 482^B	
	2.5 D Turbo	07.94-06.96	94-96 Org.-Nr. →7146		BO	0 265 201 058^H	
		07.96-12.97	94-96 Org.-Nr. 7147→7692		BO	0 265 216 341^H	
		01.98-05.99	94-96 Org.-Nr. 7693→		BO	0 265 216 482^B	
	3.0 i	07.93-06.96	123-125 Org.-Nr. →7146		BO	0 265 201 058^H	
		09.93-05.99	123-125		BO	0 265 211 008^J	
		07.96-12.97	123-125 Org.-Nr. 7147→7692		BO	0 265 216 341^H	
		03.97-12.97	140-143 Org.-Nr. 7147→7692		BO	0 265 216 341^H	
		01.98-05.99	123-125 Org.-Nr. 7693→		BO	0 265 216 482^B	
	3.0 i 24V		140-143 Org.-Nr. 7693→		BO	0 265 216 482^B	
		07.93-06.96	147 Org.-Nr. →7146		BO	0 265 201 058^H	
		09.93-05.99	147		BO	0 265 211 008^J	
		07.96-12.97	147 Org.-Nr. 7147→7692		BO	0 265 216 341^H	
		01.98-05.99	147 Org.-Nr. 7693→		BO	0 265 216 482^B	

	2.0	10.89-06.96	79		BO	0 265 100 066^H	
		07.96-12.97	79 Org.-Nr. 7147→7692	TEI	BO	1 267 000 817^H	
	2.0	06.89-06.94	79-81/84/89-90		BO	0 265 100 066^H	
	2.0 i						

		S								
2.0i Turbo		07.92-06.94	104					BO	0 265 100 066 ^H	
		07.94-06.96	104-110					BO	0 265 100 066 ^H	
		07.96-12.97	104-110	Org.-Nr. 7147→7692		TEI		BO	1 267 000 817 ^H	
2.0i		10.89-06.96	94/97-99					BO	0 265 100 066 ^H	
2.0i 16V		07.96-12.97	94/97-99	Org.-Nr. 7147→7692		TEI		BO	1 267 000 817 ^H	
2.1D		06.89-06.94	60-61					BO	0 265 100 066 ^H	
2.1D Turbo		06.89-06.96	80-81					BO	0 265 100 066 ^H	
		07.96-12.97	80-81	Org.-Nr. 7147→7692		TEI		BO	1 267 000 817 ^H	
2.5D Turbo		07.94-06.96	94-96					BO	0 265 100 066 ^H	
		07.96-12.97	94-96	Org.-Nr. 7147→7692		TEI		BO	1 267 000 817 ^H	
3.0i		07.93-06.96	123-125					BO	0 265 100 066 ^H	
		09.93-05.99	123-125					BO	0 265 106 094 ^J	
		07.96-12.97	123-125	Org.-Nr. 7147→7692		TEI		BO	1 267 000 817 ^H	
		03.97-12.97	140-143	Org.-Nr. 7147→7692		TEI		BO	1 267 000 817 ^H	
3.0i 24V		03.97-05.99	140-143					BO	0 265 106 094 ^J	
		07.93-06.96	147					BO	0 265 100 066 ^H	
		09.93-05.99	147					BO	0 265 106 094 ^J	
		07.96-12.97	147	Org.-Nr. 7147→7692		TEI		BO	1 267 000 817 ^H	
607 [Z8]										
	2.0 HDi	MFD	03.00-11.04	79/80/100					0 204 123 544	22
	2.0i 16V	OFD	03.00-11.04	79/80/100					0 204 123 545	22
	2.2 HDi	MFD	03.00-11.04	98/116					0 204 123 544	22
	2.2i 16V	OFD	03.00-11.04	98/116					0 204 123 545	22
	3.0i	MFD	03.00-11.04	152-154					0 204 123 544	22
		OFD	03.00-11.04	152-154					0 204 123 545	22
	2.0 HDi		03.01-11.04	79					0 265 202 419 ^M	
									0 265 216 863 ^B	
	2.0 HDi		03.00-10.00	80/100	Org.-Nr. →8709				0 265 216 605 ^B	
	2.0i 16V		03.00-11.04	80/100					0 265 202 419 ^M	
			11.00-11.04	80/100	Org.-Nr. 8710→				0 265 216 863 ^B	
	2.2 HDi		03.00-10.00	98/116	Org.-Nr. →8709				0 265 216 605 ^B	
	2.2i 16V		03.00-11.04	98/116					0 265 202 419 ^M	
			11.00-11.04	98/116	Org.-Nr. 8710→				0 265 216 863 ^B	
	3.0i		03.00-10.00	152-154	Org.-Nr. →8709				0 265 216 605 ^B	
		03.00-11.04	152-154					0 265 202 419 ^M		
		11.00-11.04	152-154	Org.-Nr. 8710→				0 265 216 863 ^B		
	2.0 HDi		03.01-05.02	79	Org.-Nr. →9302		EFV		0 265 109 629 ^M	
			06.02-11.04	79	Org.-Nr. 8903→		EFV		0 265 109 629 ^M	
	2.0 HDi		03.00-07.00	80/100	Org.-Nr. →8637				0 265 109 415 ^M	
	2.0i 16V		08.00-05.02	80/100	Org.-Nr. 8638→9302		EFV		0 265 109 629 ^M	
			06.02-11.04	80/100	Org.-Nr. 8903→		EFV		0 265 109 629 ^M	
	2.2 HDi		03.00-07.00	98/116	Org.-Nr. →8637				0 265 109 415 ^M	
	2.2i 16V		08.00-05.02	98/116	Org.-Nr. 8638→9302		EFV		0 265 109 629 ^M	
			06.02-11.04	98/116	Org.-Nr. 8903→		EFV		0 265 109 629 ^M	
	3.0i		03.00-07.00	152-154	Org.-Nr. →8637				0 265 109 415 ^M	
			08.00-05.02	152-154	Org.-Nr. 8638→9302		EFV		0 265 109 629 ^M	
			06.02-11.04	152-154	Org.-Nr. 8903→		EFV		0 265 109 629 ^M	
		2.0 HDi, i 16V		03.00-11.04	79/80/100					0 265 005 290
2.2 HDi, i 16V			03.00-11.04	98/116					0 265 005 290	
3.0i			03.00-11.04	152-154					0 265 005 290	
	2.0 HDi, i 16V		03.00-11.04	79/80/100					0 265 005 404	
	2.2 HDi, i 16V		03.00-11.04	98/116					0 265 005 404	
	3.0i		03.00-11.04	152-154					0 265 005 404	





◀ PEUGEOT

607 [Z9]

















	2.0 HDi	12.04-12.09	79/100			0 265 234 053 ^T	
	2.2, HDi	12.04-04.09	98/116/120/125			0 265 234 053 ^T	
	2.7 HDi	12.04-12.10	150			0 265 234 053 ^T	
	3.0	12.04-01.09	155			0 265 234 053 ^T	
	2.0 HDi	12.04-10.06	79/100	Org.-Nr. →10919		0 265 005 606	
		11.06-12.09	79/100	Org.-Nr. 10920→		0 265 005 724	
	2.2	12.04-10.06	98/116/	Org.-Nr. →10919		0 265 005 606	
	2.2 HDi		120/125				
		11.06-04.09	98/116/	Org.-Nr. 10920→		0 265 005 724	
			120/125				
	2.7 HDi	12.04-10.06	150	Org.-Nr. →10919		0 265 005 606	
		11.06-12.10	150	Org.-Nr. 10920→		0 265 005 724	
3.0	12.04-10.06	155	Org.-Nr. →10919		0 265 005 606		
	11.06-01.09	155	Org.-Nr. 10920→		0 265 005 724		

806 [U60]



	1.8 i	ABO	07.95-05.99	73	Org.-Nr. →8206			0 204 124 059 ⁶
						JBH	F 026 003 188	22,2
			06.99-08.02	73	Org.-Nr. 8207→	JBH	F 026 003 188	22,2
		ABS	07.95-05.99	73	Org.-Nr. →8206			0 204 124 136 ⁶
						JBH	F 026 003 518	22,2
			06.99-08.02	73	Org.-Nr. 8207→	JBH	F 026 003 518	22,2
1.9 D Turbo	ABO	12.94-05.99	66-68	Org.-Nr. →8206				0 204 124 073 ⁶
					JBH	F 026 003 166	23,8	
		06.99-08.02	66-68	Org.-Nr. 8207→	JBH	F 026 003 517	23,81	
		ABS	12.94-05.99	66-68	Org.-Nr. →8206			
			06.99-08.02	66-68	Org.-Nr. 8207→	JBH	F 026 003 516	23,81
2.0 HDi	ABO	08.99-08.02	80/81		JBH	F 026 003 517	23,81	
		ABS	08.99-08.02	80/81		JBH	F 026 003 516	23,81
2.0 i Turbo	ABO	06.94-05.99	108-110	Org.-Nr. →8206				0 204 124 073 ⁶
					JBH	F 026 003 166	23,8	
		06.99-08.02	108-110	Org.-Nr. 8207→	JBH	F 026 003 517	23,81	
		ABS	06.94-05.99	108-110	Org.-Nr. →8206			
			06.99-08.02	108-110	Org.-Nr. 8207→	JBH	F 026 003 516	23,81
2.0 i	ABO	06.94-05.99	89-90/	Org.-Nr. →8206				0 204 124 073 ⁶
			97-99		JBH	F 026 003 166	23,8	
2.0 i 16V		06.99-08.02	89-90/	Org.-Nr. 8207→	JBH	F 026 003 517	23,81	
			97-99					
ABS	06.94-05.99	89-90/	Org.-Nr. →8206					0 204 123 182
		97-99						
		06.99-08.02	89-90/	Org.-Nr. 8207→	JBH	F 026 003 516	23,81	
			97-99					
2.0 i 16V	ABO	09.00-08.02	100		JBH	F 026 003 517	23,81	
		ABS	09.00-08.02	100		JBH	F 026 003 516	23,81
2.1 D Turbo	ABO	04.96-08.00	80-81					0 204 124 073 ⁶
					JBH	F 026 003 166	23,8	
		ABS	04.96-08.00	80-81				0 204 123 182
								23,8
	1.9 D Turbo	12.94-08.02	66-68		LLE	0 204 125 715		
					RLE	0 204 125 109		
	2.0 HDi	06.94-08.02	80/81/		LLE	0 204 125 715		
	2.0 i		89-90		RLE	0 204 125 109		
	2.0 i Turbo	06.94-08.02	108-110			0 204 125 107		
	2.0 i 16V	05.98-09.00	97-99			0 204 125 107		
09.00-08.02		100		LLE	0 204 125 715			
				RLE	0 204 125 109			

		S							
	2.1 D Turbo	04.96-08.00	80-81				0 204 125 715		
	1.8 i	07.95-08.02	73				0 204 131 085 ^A		
	1.9 D Turbo	12.94-08.02	66-68				0 204 131 084 ^A		
	2.0 HDi, i	06.94-08.02	80/89-90				0 204 131 084 ^A		
	2.0 i Turbo, i 16V	06.94-08.02	97-99/108-110				0 204 131 082 ^A		
	2.1 D Turbo	04.96-08.00	80-81				0 204 131 084 ^A		
	1.8 i	06.97-12.99	73	Org.-Nr. 7481→8420			0 265 216 496 ^B		
		01.00-08.02	73	Org.-Nr. 8421→			0 265 216 725 ^B		
	1.9 D Turbo	06.97-12.99	66-68	Org.-Nr. 7481→8420			0 265 216 496 ^B		
		01.00-08.02	66-68	Org.-Nr. 8421→			0 265 216 725 ^B		
	2.0 HDi	08.99-12.99	80	Org.-Nr. 7481→8420			0 265 216 496 ^B		
		01.00-08.02	80	Org.-Nr. 8421→			0 265 216 725 ^B		
		06.00-08.02	81				0 265 216 725 ^B		
	2.0 i Turbo	06.97-12.99	108-110	Org.-Nr. 7481→8420			0 265 216 496 ^B		
		01.00-08.02	108-110	Org.-Nr. 8421→			0 265 216 725 ^B		
	2.0 i	06.97-12.99	89-90/	Org.-Nr. 7481→8420			0 265 216 496 ^B		
	2.0 i 16V		97-99						
		01.00-08.02	89-90/	Org.-Nr. 8421→			0 265 216 725 ^B		
			97-99						
2.0 i 16V	09.00-08.02	100	Org.-Nr. 8421→			0 265 216 725 ^B			
2.1 D Turbo	06.97-12.99	80-81	Org.-Nr. 7481→8420			0 265 216 496 ^B			
	01.00-08.00	80-81	Org.-Nr. 8421→			0 265 216 725 ^B			
807 [V2]									
									
	2.0 HDi	06.02-10.05	81	Org.-Nr. →10562			0 204 123 592	22,2	
	2.0 i 16V	06.02-05.06	100				0 204 123 592	22,2	
	2.2 HDi	06.02-10.05	94	Org.-Nr. →10562			0 204 123 592	22,2	
	2.2 i 16V	06.02-05.06	116				0 204 123 592	22,2	
	2.0 HDi	06.02-10.05	81	Org.-Nr. →10562	LLE		0 204 125 792		
					RLE		0 204 125 791		
	2.0 i 16V	06.02-05.06	100		LLE		0 204 125 792		
					RLE		0 204 125 791		
	2.2 HDi	06.02-10.05	94	Org.-Nr. →10562	LLE		0 204 125 792		
					RLE		0 204 125 791		
	2.2 i 16V	06.02-05.06	116		LLE		0 204 125 792		
					RLE		0 204 125 791		
	2.0 HDi	06.02-10.05	81	Org.-Nr. →10562			0 265 225 166 ^T		
		06.02-12.06	81				0 265 222 010 ^B		
		11.05-05.06	81	Org.-Nr. 10563→10773			0 265 234 038 ^T		
		03.06-05.06	88	Org.-Nr. →10773			0 265 234 038 ^T		
	2.0 i 16V	06.02-10.05	100	Org.-Nr. →10562			0 265 225 166 ^T		
		06.02-05.06	100				0 265 222 010 ^B		
		10.05-10.05	103	Org.-Nr. →10562			0 265 225 166 ^T		
		11.05-05.06	100	Org.-Nr. 10563→			0 265 234 038 ^T		
			103	Org.-Nr. 10563→10773			0 265 234 038 ^T		
	2.2 HDi	06.02-10.05	94	Org.-Nr. →10562			0 265 225 166 ^T		
		06.02-07.06	94				0 265 222 010 ^B		
		11.05-05.06	94	Org.-Nr. 10563→10773			0 265 234 038 ^T		
	2.2 i 16V	06.02-10.05	116	Org.-Nr. →10562			0 265 225 166 ^T		
		06.02-05.06	116				0 265 222 010 ^B		
	11.05-05.06	116	Org.-Nr. 10563→			0 265 234 038 ^T			
3.0 i	06.02-10.05	152	Org.-Nr. →10562			0 265 225 166 ^T			
	06.02-05.06	152				0 265 222 010 ^B			
	11.05-05.06	152	Org.-Nr. 10563→			0 265 234 038 ^T			





◀ PEUGEOT 807 [V2]

	2.0 HDi	06.02-10.05	81	Org.-Nr. →10562		0 265 005 290	
		11.05-12.06	81	Org.-Nr. 10563→		0 265 005 606	
		03.06-09.07	88	Org.-Nr. →11256		0 265 005 606	
		06.06-09.07	100	Org.-Nr. →11256		0 265 005 606	
		10.07-05.10	88	Org.-Nr. 11257→		0 265 005 765	
			100	Org.-Nr. 11257→		0 265 005 765	
	06.10-12.13	100			0 265 005 765		
		120			0 265 005 765		
2.0 i 16V	06.02-10.05	100	Org.-Nr. →10562		0 265 005 290		
	10.05-10.05	103	Org.-Nr. →10562		0 265 005 290		
	11.05-05.06	100	Org.-Nr. 10563→		0 265 005 606		
	11.05-09.07	103	Org.-Nr. 10563→11256		0 265 005 606		
	10.07-05.10	103	Org.-Nr. 11257→		0 265 005 765		
2.2 HDi	09.07-05.10	120-125			0 265 005 765		
2.2 HDi	06.02-10.05	94/116	Org.-Nr. →10562		0 265 005 290		
2.2 i 16V	11.05-07.06	94/116	Org.-Nr. 10563→		0 265 005 606		
3.0 i	06.02-10.05	152	Org.-Nr. →10562		0 265 005 290		
	11.05-05.06	152	Org.-Nr. 10563→		0 265 005 606		

1007 [A8]



	1.4	04.05-02.11	50/54/65		BO	0 204 123 653	22,2
	1.4 HDi	MFD 04.05-01.07	50/54/65	Org.-Nr. →11012	JBH	LUC 0 986 480 879	22,2
	1.6	MFD 04.05-01.07	80	Org.-Nr. →11012	JBH	LUC 0 986 480 879	22,2
	1.6, HDi	04.05-02.11	80		BO	0 204 123 653	22,2
	1.4, HDi	04.05-02.11	50/54/65		BO	0 204 125 820	
	1.6, HDi	04.05-02.11	80		BO	0 204 125 820	

2008 [A94]



	1.2 VTi	03.13-07.13	60	Org.-Nr. →13383		0 204 123 815	23,81
	1.2 VTi	03.13-07.13	60	Org.-Nr. →13383		0 204 720 421	

3008 [T8]



	1.6, VTi	05.09→	88			0 986 486 616	19
	2.0 HDi	05.09→	100/110		RLE	0 986 486 616	19
	1.2 THP	02.15→	96			0 265 005 765	
	1.6, HDi, THP, VTi	05.09→	80/82/84/85/88/ 110/115/120-121			0 265 005 765	
	2.0 BlueHDi, HDi, HDi HYbrid4 4x4	05.09→	100/110/120-147			0 265 005 765	

5008 [T8]



	1.6	09.09→	88			0 986 486 616	19
	2.0 HDi	09.09→	100/110		RLE	0 986 486 616	19
	1.6, HDi, HTP, THP	09.09→	80/82/84/85/88/ 110/115/120/121			0 265 005 765	
	2.0 BlueHDi, HDi	09.09→	100/110/120			0 265 005 765	



PORSCHE

Boxster [986]

	2.5	10.96-08.99	150		JBH	0 986 480 890	23,81
	2.7	MFD 09.99-08.04	162/168		JBH	0 986 480 974	23,8
		OFD 09.99-08.04	162/168		JBH	0 986 480 890	23,81
	3.2 S	MFD 09.99-08.04	185/191-196		JBH	0 986 480 974	23,8
		OFD 09.99-08.04	185/191-196		JBH	0 986 480 890	23,81
	2.5	10.96-08.99	150		MG5	0 986 486 548	22,2
	2.7	09.99-08.02	162		MG5	0 986 486 548	22,2
		09.02-08.04	168			0 986 486 548	22,2
	3.2 S	09.99-08.04	185/191-196		MG5	0 986 486 548	22,2
	2.5	10.96-08.99	150			0 265 215 402 ^B	
						0 265 219 402 ^F	
	2.7	09.99-08.00	162			0 265 215 402 ^B	
		09.99-08.02	162			0 265 219 402 ^F	
						0 265 225 076 ^T	
		09.00-08.01	162			0 265 215 505 ^B	
		09.01-08.02	162			0 265 222 026 ^B	
		09.02-08.04	168			0 265 222 026 ^B	
						0 265 225 076 ^T	
	3.2 S	09.99-08.00	185			0 265 215 402 ^B	
		09.99-08.02	185			0 265 219 402 ^F	
						0 265 225 076 ^T	
		09.00-08.01	185			0 265 215 505 ^B	
		09.01-08.02	185			0 265 222 026 ^B	
		09.02-08.04	191-196			0 265 222 026 ^B	
						0 265 225 076 ^T	

Boxster [987]

	2.7	09.04-01.09	176/180		MG5	0 986 486 548	22,2
	2.7	09.04-01.09	176/180			0 265 234 143 ^T	
	2.9	02.09-09.12	188-193			0 265 236 039 ^T	
	3.2 S	09.04-08.06	206			0 265 234 143 ^T	
	3.4 S	09.06-08.08	217-223			0 265 234 143 ^T	
	3.4 S, Spyder	09.08-09.12	228-231/235			0 265 236 039 ^T	

Cayman [987C]

	2.7	09.06-08.07	180			0 986 486 548	22,2
	2.7	09.06-01.09	180			0 265 234 143 ^T	
	2.9	02.09-12.12	195			0 265 236 039 ^T	
	3.4 R, S	02.09-12.12	235/243			0 265 236 039 ^T	
	3.4 S, S Sport	11.05-01.09	217/223			0 265 234 143 ^T	

911 Cabriolet [996]

	3.4 24V Carrera	02.98-08.99	220		JBH	0 986 480 890	23,81
	3.4 24V Carrera 4	08.98-08.01	220		JBH	0 986 480 890	23,81
		09.98-08.99	220		JBH	0 986 480 974	23,8





	◀ PORSCHE 911 Cabriolet [996]								
	3.6 Carrera	MFD	09.01-07.04	235		JBH	0 986 480 974	23,8	
			06.02-07.04	254		JBH	0 986 480 974	23,8	
		OFD	09.01-07.04	235/254		JBH	0 986 480 890	23,81	
	3.6 Carrera 4		09.01-07.04	235		JBH	0 986 480 974	23,8	
			06.02-07.04	254		JBH	0 986 480 974	23,8	
	3.4 24V Carrera		02.98-08.00	220			0 265 225 019 ^T		
	3.4 24V Carrera 4		02.98-08.01	220			0 265 215 402 ^B		
							0 265 219 402 ^F		
	3.4 24V Carrera 4		09.98-08.99	220			0 265 202 425 ^M		
	3.6 Carrera		09.01-07.04	235/254			0 265 222 026 ^B		
	3.6 Carrera, Carrera 4S		09.01-07.04	235/254			0 265 225 102 ^T		
	3.6 Carrera 4		09.01-07.04	235/254			0 265 225 100 ^T		
	3.6 Turbo S4		10.03-09.05	309/331			0 265 225 102 ^B		
							0 265 225 102 ^T		
	3.6 Turbo 4		10.03-09.05	309/331			0 265 225 102 ^B		
							0 265 225 102 ^T		

	3.4 24V Carrera 4		09.98-08.99	220			0 265 109 417 ^M	
--	-------------------	--	-------------	-----	--	--	----------------------------	--

911 Cabriolet [997]

	3.6 Carrera		04.05-05.08	235-239			0 265 234 089 ^T		
			06.08-09.12	254			0 265 236 037 ^T		
	3.6 Carrera 4		08.04-05.08	235-239			0 265 236 001 ^M		
			06.08-09.12	254			0 265 236 041 ^T		
	3.6 Turbo Carrera 4		08.07-08.09	353			0 265 236 003 ^T		
	3.8 Carrera GTS, Carrera S		06.08-09.12	283/300			0 265 236 037 ^T		
	3.8 Carrera S		04.05-05.08	261			0 265 234 089 ^T		
	3.8 Carrera 4 GTS, Carrera 4S		06.08-09.12	283/300			0 265 236 041 ^T		
	3.8 Carrera 4S		10.05-05.08	261			0 265 236 001 ^M		
	3.8 Turbo S4, Turbo 4		10.09-08.13	368/390			0 265 236 122 ^T		

911 Carrera Cabriolet [996]

	3.4 4		09.98-08.99	220		JBH	0 986 480 974	23,8	
	3.4 4		09.98-08.99	220			0 265 202 425 ^M		
	3.4 4		09.98-08.99	220			0 265 109 417 ^M		

911 Speedster [997]

	3.6		08.04-05.08	235-239			0 265 234 089 ^T		
	3.8		10.10-09.11	300			0 265 236 037 ^T		

911 Targa [993]

	3.6		09.95-08.97	210			0 265 213 006 ^B		
							0 265 213 006 ^H		
							0 265 217 006 ^F		
							0 265 217 006 ^K		
	3.6 4		09.95-08.97	210			0 265 217 006 ^K		

		S							
	3.6		09.95-08.97	210			0 265 108 001 ^H		
							0 265 109 025 ^K		
	3.6 4		09.95-08.97	210			0 265 109 025 ^K		
911 Targa [996]									
	3.6 Carrera	MFD	12.01-07.04	235/254		JBH	0 986 480 974	23,8	
		OFD	12.01-07.04	235/254		JBH	0 986 480 890	23,81	
	3.6 Carrera		12.01-07.04	235/254			0 265 222 026 ^B		
							0 265 225 102 ^T		
911 Targa [997]									
	3.6 4		08.06-05.08	235-239			0 265 236 001 ^M		
			06.08-09.12	254			0 265 236 041 ^T		
	3.8 4S		08.06-05.08	261			0 265 236 001 ^M		
			06.08-09.12	283			0 265 236 041 ^T		
911 [993]									
	3.6 Carrera		09.93-08.95	200			0 265 213 006 ^B		
							0 265 213 006 ^H		
							0 265 217 006 ^F		
							0 265 217 006 ^K		
			09.94-08.98	210			0 265 213 006 ^H		
							0 265 217 006 ^K		
	3.6 Carrera S4, Carrera 4		09.95-08.97	210			0 265 217 006 ^K		
	3.6 Carrera 4		09.94-08.95	200			0 265 217 006 ^K		
	3.6 Turbo, Turbo Carrera GT2		01.95-08.97	300/316			0 265 217 006 ^K		
	3.8 Carrera RS		09.94-08.97	200-221			0 265 213 006 ^H		
							0 265 217 006 ^K		
	3.6 Carrera		09.93-08.94	200			0 265 109 009 ^K		
			09.93-08.95	200			0 265 108 001 ^H		
			09.94-08.95	200			0 265 109 025 ^K		
			09.94-08.98	210			0 265 108 001 ^H		
	3.6 Carrera S4, Carrera 4		09.95-08.97	210			0 265 109 025 ^K		
	3.6 Carrera 4		09.94-08.95	200			0 265 109 025 ^K		
	3.6 Turbo, Turbo Carrera GT2		01.95-08.97	300/316			0 265 109 025 ^K		
	3.8 Carrera RS		09.94-08.97	200-221			0 265 108 001 ^H		
	3.6 Carrera, Carrera 4		09.93-08.95	200		FMT	0 265 005 108 ⁵		
911 [996]									
	3.4 24V Carrera		09.97-08.01	220		JBH	0 986 480 890	23,81	
	3.4 24V Carrera 4		09.98-08.99	220		JBH	0 986 480 974	23,8	
	3.6 Carrera	MFD	09.01-07.04	235		JBH	0 986 480 974	23,8	
			06.02-07.04	254-257		JBH	0 986 480 974	23,8	
		OFD	09.01-07.04	235/254-257		JBH	0 986 480 890	23,81	
	3.6 Carrera 4		09.01-07.04	235		JBH	0 986 480 974	23,8	
			06.02-07.04	254		JBH	0 986 480 974	23,8	
	3.4 24V Carrera		09.97-08.99	220			0 265 215 402 ^B		
							0 265 219 402 ^F		



		S							
	◀ PORSCHE 911 [996]								
	3.4 24V Carrera	09.97-08.00	220				0 265 225 019 ^T		
		09.00-08.01	220				0 265 225 098 ^T		
	3.4 24V Carrera 4	09.98-08.99	220				0 265 202 425 ^M		
	3.6 Carrera	09.01-07.04	235				0 265 222 026 ^B		
		06.02-07.04	254-257				0 265 222 026 ^B		
							0 265 225 102 ^T		
	3.6 Carrera, Carrera 4S	09.01-07.04	235				0 265 225 102 ^T		
	3.6 Carrera 4	09.01-07.04	235/254				0 265 225 100 ^T		
	3.6 Carrera 4S	06.02-07.04	254				0 265 225 102 ^T		
	3.6 GT2	06.01-08.03	340				0 265 215 523 ^B		
		09.03-09.04	340				0 265 222 033 ^B		
		10.04-09.05	340-360				0 265 222 033 ^B		
	3.6 GT3	03.99-08.00	265				0 265 215 402 ^B		
		10.03-09.05	280				0 265 222 033 ^B		
	3.6 Turbo S4	02.03-09.05	331				0 265 225 102 ^B		
							0 265 225 102 ^T		
	3.6 Turbo 4	06.00-09.05	309				0 265 225 102 ^T		
	3.4 24V Carrera 4	09.98-08.99	220				0 265 109 417 ^M		
911 [997]									
	3.6 Carrera	06.08-09.12	254				0 265 236 037 ^T		
	3.6 Carrera 4	08.04-05.08	235-239				0 265 236 001 ^M		
		06.08-09.12	254				0 265 236 041 ^T		
	3.6 GT2	09.07-08.09	390				0 265 236 043 ^T		
	3.6 GT2 RS	09.10-08.11	456				0 265 236 120 ^T		
	3.6 GT3	03.06-12.08	305				0 265 236 014 ^T		
	3.6 Turbo Carrera 4	03.06-08.09	353				0 265 236 003 ^T		
	3.8 Carrera GTS, Carrera S, Sport Classic	06.08-09.12	283/300				0 265 236 037 ^T		
	3.8 Carrera S	08.04-05.08	261				0 265 234 089 ^T		
	3.8 Carrera 4 GTS, Carrera 4S	06.08-09.12	283/300				0 265 236 041 ^T		
	3.8 Carrera 4S	10.05-05.08	261				0 265 236 001 ^M		
	3.8 GT3, GT3 RS	08.09-08.11	320/331				0 265 236 120 ^T		
	3.8 Turbo S4, Turbo 4	10.09-08.13	368/390				0 265 236 122 ^T		
918 Spyder [918]									
	4	03.14-06.15	447				0 204 818 725		
928									
	5.4 GTS	08.91-11.95	257				0 265 200 065 ^H		
968									
	3.0	08.91-11.95	176/224				0 986 480 951		
	3.0 Turbo S								
	3.0	08.91-11.95	176				0 265 200 064 ^H		
	3.0	08.93-08.95	176		FMT		0 265 005 108 ^S		



PROTON

Arena Pickup

	1.5i	01.01-01.07	66	F 026 A01 693
--	------	-------------	----	----------------------

GEN2

	1.3i	02.04→	70	0 986 AB8 512
	1.6i	02.04→	82	0 986 AB8 512

Savvy [BT2]

	1.2i	06.05→	55	0 986 AB8 516
--	------	--------	----	----------------------

Waja [CF1]

	1.6i	ABS 09.00→	76	0 986 AB8 512
	1.6i CAMPRO			
	1.6i CAMPRO	01.08→	76	F 01G 29E 02L^B

Waja [CF2]

	1.8i (AT)	ABS 03.02→	88	0 986 AB8 512
	1.8i (MT)			

Wira Aeroback

	1.5	05.93-06.01	63-66	F 026 A01 693
	1.5	05.95-11.96	63-66	F 026 A01 877

RENAULT

Alpine [D503]

	A 610 3.0i Turbo	03.91-12.95	184	0 265 200 036^H
	A 610 3.0i Turbo	08.92-12.95	184	0 265 005 041



		S							
◀ RENAULT									
Avantime [XEO]									
	2.0 16V Turbo	09.01-12.03	120			JBH,TKO	0 986 480 921	23,81	
	2.2 DCI	12.01-12.03	110			JBH,TKO	0 986 480 921	23,81	
	3.0 V6 24V	09.01-12.03	152			JBH,TKO	0 986 480 921	23,81	
	2.0 16V Turbo	09.01-12.03	120			TKO	0 265 216 727 ^B		
	2.2 DCI	12.01-12.03	110			TKO	0 265 225 184 ^B		
	3.0 V6 24V	09.01-12.03	152			TKO	0 265 216 727 ^B		
						TKO	0 265 225 184 ^B		
B									
	80 Messenger	08.90-06.99	55/56						0 204 120 023
	90, 4x2, 4x4	01.86-06.94	68-71/78						0 204 120 023
	110 Messenger 4x2, Messenger 4x4	08.90-06.99	78						0 204 120 023
	120 Messenger, Messenger 4x2, Messenger 4x4	10.91-06.01	85/90						0 204 120 023
Clio I									
	1.9 D	04.95-10.00	48			JBH ATE	F 026 003 243	20,6	
		ABO 04.95-10.00	48			JBH BSY	F 026 003 180	20,6	
Clio I [X57]									
	Electrique	06.95-02.98	21			JBH ATE	F 026 003 180	20,6	
	1.1	06.90-03.96	35-36			FAH,JBH	ATE F 026 003 103	19	
						JBH,TW	F 026 003 180	20,6	
						ATE	F 026 003 243	20,6	
	1.2	ABS 06.90-02.98	40-44			LLE BSY	0 204 123 176	20,6	
	1.2	06.90-02.98	40-44			FAH,JBH	ATE F 026 003 103	19	
	1.2 i					JBH,TW	F 026 003 180	20,6	
						ATE	F 026 003 243	20,6	
	1.2 i	02.92-03.96	40			FAH,JBH	F 026 003 103	19	
		01.94-03.96	40			FAH,JBH	ATE F 026 003 103	19	
						JBH,TW	F 026 003 180	20,6	
						ATE	F 026 003 243	20,6	
		ABO 06.90-03.96	40			JBH	F 026 003 180	20,6	
		04.95-03.96	40			JBH,LLE	ATE F 026 003 243	20,6	
		ABS 06.90-03.96	40			LLE	0 204 123 176	20,6	
						RLE	0 204 123 357	19	
		06.90-02.98	40-44			LLE BSY	0 204 123 176	20,6	
						RLE BSY	0 204 123 357	19	
		01.94-03.96	40			LLE BSY	0 204 123 176	20,6	
						RLE BSY	0 204 123 357	19	
	1.4	06.90-02.98	55-57			FAH,JBH	ATE F 026 003 103	19	
		ABO 06.90-03.96	55-57			JBH,TW	BSY F 026 003 103	19	
	1.4	06.90-02.98	55-57			JBH,TW	F 026 003 180	20,6	
	1.4 i					ATE	F 026 003 243	20,6	
	1.4 i	04.90-02.98	55-58			JBH,TW	F 026 003 180	20,6	
						ATE	F 026 003 243	20,6	
		06.90-03.96	55-57			FAH,JBH	ATE F 026 003 103	19	
		06.90-02.98	58-59			FAH,JBH	ATE F 026 003 103	19	
						JBH,TW	F 026 003 180	20,6	
						ATE	F 026 003 243	20,6	





1.4i		01.94-02.98	55	FAH,JBH	ATE	F 026 003 103	19				
				JBH,TW		F 026 003 180	20,6				
			55-58		ATE	F 026 003 243	20,6				
	ABO	06.90-02.98	58-59	FAH,JBH	ATE	F 026 003 103	19				
		01.94-02.98	55-58	JBH,TW	BSY	F 026 003 103	19				
	ABS	04.90-02.98	55-59	LLE	BSY	0 204 123 176	20,6				
				RLE	BSY	0 204 123 357	19				
1.7		06.90-03.96	66-68	FAH,JBH	ATE	F 026 003 103	19				
				JBH,TW		F 026 003 180	20,6				
					ATE	F 026 003 243	20,6				
	ABS	06.90-03.96	66-68	LLE	BSY	0 204 123 176	20,6				
				RLE	BSY	0 204 123 357	19				
1.8i		06.90-02.98	65-70	FAH,JBH	ATE	F 026 003 103	19				
				JBH,TW		F 026 003 180	20,6				
					ATE	F 026 003 243	20,6				
					07.92-02.98	80-81	JBH,TW		F 026 003 180	20,6	
					01.94-02.98	66	FAH,JBH	ATE	F 026 003 103	19	
							JBH,TW		F 026 003 180	20,6	
								ATE	F 026 003 243	20,6	
						80-81	FAH,JBH	ATE	F 026 003 103	19	
						09.96-02.98	79-81	JBH,TW		F 026 003 180	20,6
					ABO	06.90-02.98	65-70	JBH,TW	BSY	F 026 003 103	19
						07.92-02.98	80-81	JBH,TW	BSY	F 026 003 103	19
						01.94-02.98	66	JBH,TW	BSY	F 026 003 103	19
		09.96-02.98	79-81	JBH,TW	BSY	F 026 003 103	19				
1.8i	ABS	06.90-02.98	65-70/79-81/	LLE	BSY	0 204 123 176	20,6				
1.8i 16V			99-103	RLE	BSY	0 204 123 357	19				
1.8i 16V		03.91-03.96	99-103	JBH,TW		F 026 003 180	20,6				
	ABO	03.91-03.96	99-101	JBH,TW	BSY	F 026 003 103	19				
1.9D		06.90-02.98	47-48	FAH,JBH	ATE	F 026 003 103	19				
				JBH,TW		F 026 003 180	20,6				
					ATE	F 026 003 243	20,6				
	ABS	06.90-02.98	47-48	LLE	BSY	0 204 123 176	20,6				
				RLE	BSY	0 204 123 357	19				
2.0i Williams		07.92-03.96	108-110	JBH,TW		F 026 003 180	20,6				
				ABO	07.92-03.96	108-110	JBH,TW	BSY	F 026 003 103	19	
				ABS	07.92-03.96	108-110	LLE	BSY	0 204 123 176	20,6	
				RLE	BSY	0 204 123 357	19				



1.1		06.90-03.96	35-36	TW	BSY	0 204 125 115	
						0 204 125 153	
						0 204 125 161	
1.2		06.90-02.98	40-44	TW	BSY	0 204 125 115	
						0 204 125 153	
						0 204 125 161	
1.4		04.90-02.98	55-59	TW	BSY	0 204 125 115	
						0 204 125 153	
						0 204 125 161	
1.4i						0 204 125 115	
						0 204 125 153	
						0 204 125 161	
1.7		06.90-03.96	66-68	TW	BSY	0 204 125 115	
						0 204 125 153	
						0 204 125 161	
1.8i		06.90-02.98	65-70/ 79-81	TW	BSY	0 204 125 115	
						0 204 125 153	
						0 204 125 161	
1.8i 16V		03.91-03.96	99-103	TW	BSY	0 204 125 153	
						0 204 125 161	
1.9D		06.90-02.98	47-48	TW	BSY	0 204 125 115	
						0 204 125 153	
						0 204 125 161	
2.0i Williams		07.92-03.96	108-110	TW	BSY	0 204 125 153	
						0 204 125 161	





◀RENAULT Clio I [X57]

	1.2 i	04.96-02.98	40-44	LWG	0 204 131 188 ^A		
					0 204 131 188 ^A		
				44		0 204 131 188 ^A	
	ABS	06.90-03.95	44		0 204 131 178 ^A		
				01.94-03.95	40	0 204 131 178 ^A	
				04.95-03.96	40	0 204 131 188 ^A	
				04.95-02.98	44	0 204 131 188 ^A	
	1.4 i	ABS	01.94-03.95	55-59		0 204 131 178 ^A	
					04.95-02.98	55-59	0 204 131 188 ^A
	1.7		01.94-03.95	66-68		0 204 131 178 ^A	
04.95-03.96					66-68	0 204 131 188 ^A	
1.8 i		07.92-01.94	80-81		0 204 131 147 ^A		
				01.94-03.95	65-70	0 204 131 178 ^A	
			80-81	0 204 131 178 ^A			
		04.95-02.98	65-70		0 204 131 188 ^A		
				80-81	0 204 131 188 ^A		
09.96-02.98	79-81	0 204 131 188 ^A					
1.8 i 16V		03.91-03.96	101-103		0 204 131 146 ^A		
1.9 D	ABS	04.95-02.98	47-48		0 204 131 188 ^A		

	Electrique	06.95-02.98	21	TEI	2 267 000 704 ^H		
	1.1	06.90-03.96	35-36	TEI	2 267 000 704 ^H		
	1.2	06.90-02.98	40-44	TEI	2 267 000 704 ^H		
	1.2 i	04.96-02.98	40-44		2 267 000 739 ^H		
	1.2 i	06.90-02.98	40-41	TEI	2 267 000 704 ^H		
	1.4, i	06.90-02.98	55-57		2 267 000 704 ^H		
				04.90-02.98	55-59	TEI	2 267 000 704 ^H
	1.4 i	01.94-02.98	55		2 267 000 704 ^H		
				04.96-02.98	55	2 267 000 739 ^H	
				55-59	2 267 000 739 ^H		
	1.7	06.90-03.96	66-68	TEI	2 267 000 704 ^H		
	1.8 i	06.90-02.98	65-70/79-81		2 267 000 704 ^H		
				04.96-02.98	65-70/79-81	2 267 000 739 ^H	
	1.8 i 16V	03.91-03.96	99-103	TEI	2 267 000 704 ^H		
	1.9 D	06.90-02.98	47-48		2 267 000 704 ^H		
04.96-02.98				47-48	2 267 000 739 ^H		
2.0 i Williams	07.92-03.96	108-110	TEI	2 267 000 704 ^H			

Clio II

	1.0 i 16V	01.01-01.05	52	JBH	ATE	0 986 480 888	20,6						
						0 986 480 984	20,6						
						ABO	01.01-01.05	52	BSY	F 026 003 418	20,64		
						ABS	01.01-01.05	52	BSY	F 026 003 417	20,64		
									JBH	ATE	0 986 481 036	20,64	
						1.2 i 16V	ABO	01.02→	55	BSY	F 026 003 418	20,64	
						1.6 i 8V	ABO	09.99-12.02	66		F 026 003 418	20,64	
										ABS	09.99-12.02	66	F 026 003 417
										JBH	ATE	0 986 481 036	20,64

	1.0 i 16V	01.01-01.05	52		0 204 032 621	
	1.6 i 8V	06.99-04.03	66/74		0 204 032 621	

	1.0 i 16V	01.01-01.05	52		0 204 031 296 ^A	
	1.6 i 8V	09.99-12.02	66		0 204 031 296 ^A	

	1.0 i 16V	01.01-01.05	52		0 265 231 334 ^B	
				TW	0 265 232 070 ^B	
				44Z	0 265 225 260 ^T	
1.6 i 8V	09.99-12.02	66		0 265 216 703 ^B		

Clio II [BB/CB/SB]										
	1.0i	ABO	03.99-11.04	43/50				BSY	F 026 003 418	20,64
	1.0i 16V							JBH	ATE 0 986 480 984	20,6
		ABS	03.99-11.04	43/50					F 026 003 417	20,64
	1.2	ABO	03.98→	43				LLE	BSY F 026 003 418	20,64
	1.2i							JBH,LLE	ATE 0 986 480 984	20,6
								RLE	0 204 123 416	20,64
		ABS	03.98→	43				LLE	F 026 003 417	20,64
								JBH,RLE	F 026 003 415	20,64
	1.2i 16V	ABO	03.00-03.04	55				LLE	BSY F 026 003 418	20,64
								JBH,LLE	ATE 0 986 480 984	20,6
			04.04-10.07	55				LLE	F 026 003 418	20,64
	1.2i 16V	ABO	03.00→	55				RLE	0 204 123 416	20,64
	1.2 16V	ABS	03.00→	55				LLE	F 026 003 417	20,64
								JBH,RLE	F 026 003 415	20,64
			10.03→	55				RLE	0 204 123 590	20,6
	1.2 16V	ABO	10.03→	55				LLE	F 026 003 418	20,64
	1.4i	ABS	03.98-10.07	55				LLE	F 026 003 417	20,64
								JBH,RLE	F 026 003 415	20,64
	1.4i	ABO	03.98-10.07	55/70-72				LLE	BSY F 026 003 418	20,64
	1.4i 16V							JBH,LLE	ATE 0 986 480 984	20,6
								RLE	0 204 123 416	20,64
	1.4i 16V	ABS	10.99-10.07	70-72				LLE	F 026 003 417	20,64
								JBH,RLE	F 026 003 415	20,64
								RLE	0 204 123 590	20,6
	1.5 dCi		06.01-10.07	60				LLE	F 026 003 417	20,64
								JBH	F 026 003 415	20,64
								JBH,RLE	F 026 003 415	20,64
								RLE	0 204 123 590	20,6
			03.03-10.07	74				JBH,LLE	0 986 480 888	20,6
								RLE	F 026 003 417	20,64
			02.07→	62					F 026 003 417	20,64
			04.07→	47				JBH	0 986 481 036	20,64
		ABO	06.01-10.07	48				LLE	BSY F 026 003 418	20,64
								JBH,LLE	ATE 0 986 480 984	20,6
								RLE	0 204 123 416	20,64
		ABS	06.01-10.07	48				LLE	F 026 003 417	20,64
								JBH,RLE	F 026 003 415	20,64
								RLE	0 204 123 590	20,6
	1.6i	ABO	03.98-10.07	66				LLE	BSY F 026 003 418	20,64
								JBH,LLE	ATE 0 986 480 984	20,6
								RLE	0 204 123 416	20,64
			10.99-10.07	66					BSY F 026 003 418	20,64
								JBH	ATE 0 986 480 984	20,6
			01.01-10.07	66				LLE	F 026 003 418	20,64
		ABS	03.98-10.07	66				LLE	F 026 003 417	20,64
								JBH,RLE	F 026 003 415	20,64
			10.99-10.07	66					F 026 003 417	20,64
			01.01-10.07	66				RLE	0 204 123 590	20,6
	1.6i	ABO	06.98-10.07	79/81				LLE	BSY F 026 003 418	20,64
	1.6i 16V							JBH,LLE	ATE 0 986 480 984	20,6
								RLE	0 204 123 416	20,64
		ABS	06.98-10.07	79/81				LLE	F 026 003 417	20,64
								JBH,RLE	F 026 003 415	20,64
	1.9D	ABO	03.98-10.07	47-48					BSY F 026 003 418	20,64
								LLE	BSY F 026 003 418	20,64
								JBH,LLE	ATE 0 986 480 984	20,6
								JBH	ATE 0 986 480 984	20,6
								RLE	0 204 123 416	20,64



			S							
◀ RENAULT Clio II [BB/CB/SB]										
1.9 D	ABS	03.98-10.07	47-48					F 026 003 417	20,64	
				LLE		F 026 003 417	20,64			
				JBH,RLE		F 026 003 415	20,64			
1.9 D DTI	ABO	03.99-10.07	59					F 026 003 418	20,64	
				LLE	BSY	F 026 003 418	20,64			
				JBH,LLE	ATE	0986 480 984	20,6			
				RLE		0204 123 416	20,64			
				LLE		F 026 003 417	20,64			
2.0 16V	ABS	03.99-10.07	124					0204 123 371	22,2	
				ABO	06.01-10.07	124		F 026 003 372	22	
				ABO	06.01-10.07	124		0204 123 371	22,2	
1.0 i, i 16V	ABO	03.99-11.04	43/50					0204 125 733		0204 120 023
				LLE		0204 125 733		0204 120 023		
1.2	ABS	10.99→	43					0204 125 795		0204 120 023
1.2	ABS	03.98→	43					0204 125 796		0204 120 023
1.2 i	ABO	03.98-10.07	43					0204 125 733		0204 120 023
				LLE		0204 125 733		0204 120 023		
1.2 i 16V	ABS	03.00-10.07	55					0204 125 796		0204 120 023
1.2 i 16V, 16V		03.00→	55					0204 125 733		0204 120 023
1.2 16V	ABS	10.03-01.04	55					0204 125 788		0204 120 023
				RLE		0204 125 796		0204 120 023		
1.4 i	ABO	03.98-10.07	55					0204 125 733		0204 120 023
				LLE		0204 125 733		0204 120 023		
1.4 i 16V	ABS	10.99-01.04	70-72					0204 125 788		0204 120 023
				RLE		0204 125 795		0204 120 023		
				LLE		0204 125 796		0204 120 023		
				RLE		0204 125 796		0204 120 023		
1.5 dCi	ABO	06.01-10.07	48					0204 125 733		0204 120 023
				LLE		0204 125 795		0204 120 023		
				RLE		0204 125 796		0204 120 023		
				TW				0204 120 023		
				LLE		0204 125 733		0204 120 023		
				LLE		0204 125 795		0204 120 023		
				RLE		0204 125 796		0204 120 023		
				RLE		0204 125 796		0204 120 023		
				LLE		0204 125 733		0204 120 023		
				LLE		0204 125 788		0204 120 023		
1.6 i	ABS	03.03-10.07	74					0204 125 796		0204 120 023
				RLE		0204 125 796		0204 120 023		
				LLE		0204 125 796		0204 120 023		
				RLE		0204 125 796		0204 120 023		
				LLE		0204 125 796		0204 120 023		
				RLE		0204 125 796		0204 120 023		
1.6 i	ABS	02.04-10.07	48/60					0204 125 796		0204 120 023
				RLE		0204 125 796		0204 120 023		
1.6 i	ABS	03.98-10.07	66					0204 125 733		0204 120 023
				LLE		0204 125 733		0204 120 023		
1.6 i	ABS	10.99-10.07	66					0204 125 733		0204 120 023
				LLE		0204 125 733		0204 120 023		
1.6 i	ABS	01.01-01.04	66					0204 125 788		0204 120 023
				RLE		0204 125 788		0204 120 023		
1.6 i	ABS	01.01-10.07	66					0204 125 733		0204 120 023
				LLE		0204 125 733		0204 120 023		
1.6 i	ABS	02.04-10.07	66					0204 125 796		0204 120 023
				RLE		0204 125 796		0204 120 023		
1.6 i 16V	ABS	06.98-10.07	79					0204 125 733		0204 120 023
1.9 D	ABS	03.98-10.07	47-48					0204 125 733		0204 120 023
				LLE		0204 125 733		0204 120 023		
1.9 D DTI	ABO	03.99-10.07	59					0204 125 733		0204 120 023
				LLE		0204 125 733		0204 120 023		
				RLE		0204 125 733		0204 120 023		
2.0 16V	ABS	08.00-10.07	59					0204 125 733		0204 120 023
				LLE		0204 125 733		0204 120 023		
				RLE		0204 125 795		0204 120 023		
2.0 16V	ABS	08.00-10.07	59					0204 125 795		0204 120 023
				LLE		0204 125 795		0204 120 023		
				RLE		0204 125 795		0204 120 023		
				LLE		0204 125 795		0204 120 023		
2.0 16V	ABS	03.99-10.07	124					0204 125 763		0204 120 023
				LLE		0204 125 763		0204 120 023		
				RLE		0204 125 763		0204 120 023		
2.0 16V	ABS	06.01-10.07	124					0204 125 733		0204 120 023
				LLE		0204 125 733		0204 120 023		
				RLE		0204 125 763		0204 120 023		
2.0 16V	ABS	03.03-10.07	124					0204 125 733		0204 120 023
				LLE		0204 125 733		0204 120 023		
1.0 i, i 16V	ABO	03.99-11.04	43/50					0204 031 296^A		
				LLE		0204 031 296^A				
1.2 i, i 16V, 16V	ABS	03.98→	43/55					0204 031 296^A		
1.4 i, i 16V	ABS	03.98-10.07	55/70-72					0204 031 296^A		
1.5 dCi	ABS	06.01→	47/48/50/60/74					0204 031 296^A		
1.6 i, i 16V	ABS	03.98-10.07	66/79/81					0204 031 296^A		
1.9 D, D DTI	ABS	03.98-10.07	47-48/59					0204 031 296^A		
2.0 16V	ABS	03.99-10.07	124					0204 031 296^A		



	1.0i	03.99-06.01	43		0 265 216 703^B	
		07.01-11.02	43		0 265 216 873^B	
		12.02-11.04	43		0 265 231 334^B	
1.0i 16V	06.01-11.04	50			0 265 231 334^B	
				44Z	0 265 225 260^T	
1.2	07.08→	43			0 265 232 372^B	
1.2	03.98-11.99	43			0 265 216 627^B	
1.2i	12.99-08.00	43			0 265 216 703^B	
	09.00-11.02	43			0 265 216 873^B	
	12.02-06.08	43			0 265 231 334^B	
1.2i 16V	03.00-11.02	55		LLE	0 265 216 873^B	
				RLE	0 265 216 703^B	
	12.02-10.07	55			0 265 231 334^B	
1.2 16V	04.04-10.07	55		44Z	0 265 225 260^T	
	10.03-06.08	55			0 265 231 334^B	
	10.03→	55		44Z	0 265 225 260^T	
	07.08→	55			0 265 232 372^B	
1.4i	03.98-11.99	55			0 265 216 627^B	
	12.99-08.00	55			0 265 216 703^B	
	09.00-11.02	55			0 265 216 873^B	
	12.02-10.07	55			0 265 231 334^B	
1.4i 16V	10.99-08.00	70			0 265 216 703^B	
		70-72			0 265 216 703^B	
	05.00-06.01	70			0 265 216 703^B	
	05.00-11.02	70		LLE	0 265 216 873^B	
				RLE	0 265 216 703^B	
	05.00-10.07	70		44Z	0 265 225 260^T	
	09.00-11.02	70			0 265 216 873^B	
		70-72			0 265 216 873^B	
	07.01-11.02	70			0 265 216 873^B	
	12.02-10.07	70			0 265 231 334^B	
		70-72			0 265 231 334^B	
	1.5 dCi	06.01-11.02	48		LLE	0 265 216 873^B
					RLE	0 265 216 703^B
			60			0 265 216 873^B
					LLE	0 265 216 873^B
				RLE	0 265 216 703^B	
06.01-10.07		48		44Z	0 265 225 260^T	
		60		44Z	0 265 225 260^T	
12.02-10.07		48			0 265 231 334^B	
		60			0 265 231 334^B	
03.03-10.07		74		44Z	0 265 225 260^T	
10.05-10.07		50			0 265 231 334^B	
				44Z	0 265 225 260^T	
02.07-06.08		62			0 265 231 334^B	
02.07→		62		44Z	0 265 225 260^T	
04.07-06.08		47			0 265 231 334^B	
04.07→	47		44Z	0 265 225 260^T		
07.08→	47			0 265 232 372^B		
1.6i	03.98-11.99	66			0 265 216 627^B	
	10.99-08.00	66			0 265 216 703^B	
		81			0 265 216 703^B	
	12.99-08.00	66			0 265 216 703^B	
	09.00-11.02	66			0 265 216 873^B	
		81			0 265 216 873^B	
	01.01-06.01	66			0 265 216 703^B	
	01.01-10.07	66		44Z	0 265 225 260^T	
	06.01-11.02	66			0 265 216 873^B	
	12.02-10.07	66			0 265 231 334^B	
	81			0 265 231 334^B		
1.6i 16V	06.98-11.99	79			0 265 216 627^B	
	06.98-10.07	79		44Z	0 265 225 260^T	



		S							
RENAULT Clio II [BB/CB/SB]									
	1.6 i 16V	12.99-08.00	79				0 265 216 703 ^B		
		09.00-11.02	79				0 265 216 873 ^B		
		12.02-10.07	79				0 265 231 334 ^B		
	1.9 D	03.98-11.99	47-48				0 265 216 627 ^B		
		03.99-08.00	47-48				0 265 216 703 ^B		
		09.00-11.02	47-48				0 265 216 873 ^B		
		12.02-10.07	47-48				0 265 231 334 ^B		
	1.9 D DTI	03.99-11.99	59				0 265 216 627 ^B		
		12.99-08.00	59				0 265 216 703 ^B		
		08.00-11.02	59				0 265 216 873 ^B		
		12.02-10.07	59				0 265 231 334 ^B		
	2.0 16V	06.01-10.07	124				0 265 225 110 ^T		
		12.02-10.07	124				0 265 231 334 ^B		
		03.03-10.07	124		44Z		0 265 225 260 ^T		
	3.0 24V Sport	09.00-06.05	170/188			0 265 215 515 ^H			
	1.0 i, i 16V	03.99-11.04	43/50				0 265 005 263		
	1.2, i, i 16V, 16V	03.98→	43/55				0 265 005 263		
	1.4 i, i 16V	03.98-10.07	55/70-72				0 265 005 263		
	1.5 dCi	06.01→	47/48/50/60/62/74				0 265 005 263		
	1.6 i, i 16V	03.98-10.07	66/79/81				0 265 005 263		
	1.9 D, D DTI	03.98-10.07	47-48/59				0 265 005 263		
	2.0 16V	03.99-10.07	124				0 265 005 263		
Clio II [BB07]									
		1.5 dCi	ABO 06.03→	48		BSY	F 026 003 418	20,64	
Clio II [CB01]									
		1.6 i 16V	05.00-12.06	81		JBH ATE	0 986 480 984	20,6	
			ABO 05.00-12.06	81		BSY	F 026 003 418	20,64	
			ABS 05.00-12.06	81		JBH	0 986 481 036	20,64	
		1.6 i 16V	05.00-12.06	81			0 204 032 621		
		1.6 i 16V	05.00-12.06	81			0 204 031 296 ^A		
Clio II Sedan									
		1.6 i 16V	ABO 01.01-10.04	81		BSY	F 026 003 418	20,64	
						JBH ATE	0 986 480 984	20,6	
			ABS 01.01-10.04	81		BSY	F 026 003 417	20,64	
						JBH ATE	0 986 481 036	20,64	
		1.6 i 16V	01.01-10.04	81			0 204 032 621		
		1.6 i 16V	01.01-10.04	81			0 204 031 296 ^A		
		1.6 i 16V	01.01-10.04	81			0 265 231 334 ^B		
						TW	0 265 232 070 ^B		
						44Z	0 265 225 260 ^T		

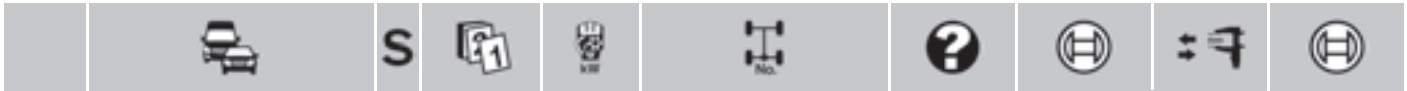

Clio III [BR/CR]



	1.2		06.05-12.08	48		HTB,LLE	ATE	0 986 481 057	23,81
	1.2	OFD	06.05-11.07	55/57,5/74		LLE	ATE	0 986 481 057	23,81
	1.2 TCe		12.07→	55/57,5/74		JBH,LLE		0 986 480 886	23,8
	1.4	OFD	06.05-11.07	72		LLE	ATE	0 986 481 057	23,81
			12.07→	72		JBH,LLE		0 986 480 886	23,8
	1.5 dCi		06.05-10.09	50		HTB,LLE	ATE	0 986 481 057	23,81
				63		HTB,LLE	ATE	0 986 481 057	23,81
		OFD	06.05-11.07	50		LLE	ATE	0 986 481 057	23,81
				63		LLE	ATE	0 986 481 057	23,81
				65/78		LLE	ATE	0 986 481 057	23,81
			12.07→	50		JBH,LLE		0 986 480 886	23,8
				63		JBH,LLE		0 986 480 886	23,8
				65/78		JBH,LLE		0 986 480 886	23,8
			11.10→	55		JBH,LLE		0 986 480 886	23,8
	1.6	OFD	06.05-11.07	65/82		LLE	ATE	0 986 481 057	23,81
			12.07→	65/82		JBH,LLE		0 986 480 886	23,8
			09.09→	94		JBH,LLE		0 986 480 886	23,8
	2.0	OFD	06.05-11.07	102		LLE	ATE	0 986 481 057	23,81
			12.07→	102		JBH,LLE		0 986 480 886	23,8

	1.2		06.05→	48/55/				0 265 232 078 ^B	
	1.2 TCe			57,5/74				0 265 234 158 ^T	
	1.4		06.05→	72				0 265 232 078 ^B	
								0 265 234 158 ^T	
	1.5 dCi		06.05→	50				0 265 232 078 ^B	
				63				0 265 234 158 ^T	
				78				0 265 232 078 ^B	
								0 265 234 158 ^T	
			11.05→	65				0 265 232 078 ^B	
								0 265 234 158 ^T	
			11.10→	55				0 265 232 078 ^B	
						TW		0 265 234 158 ^T	
				65		TW		0 265 234 158 ^T	
	1.6		06.05→	65/82				0 265 232 078 ^B	
								0 265 234 158 ^T	
			09.09→	94				0 265 232 078 ^B	
						TW		0 265 234 158 ^T	
	2.0		06.05→	102				0 265 232 078 ^B	
						TW		0 265 234 158 ^T	
	2.0 R.S.		11.09→	147,5				0 265 234 803 ^T	

	1.2, TCe		06.05→	48/55/57,5/74				0 265 005 263	
	1.4		06.05→	72				0 265 005 263	
	1.5 dCi		06.05→	50/55/63/65/78				0 265 005 263	
	1.6		06.05→	65/82/94				0 265 005 263	
	2.0, R.S., Sport		06.05→	102/145/147,5				0 265 005 263	

Clio III Grandtour [KR]



	1.2	OFD	08.07-11.07	55/57,5/74		LLE	ATE	0 986 481 057	23,81
	1.2 TCe		12.07→	55/57,5/74		JBH,LLE		0 986 480 886	23,8
	1.4	OFD	08.07-11.07	72		LLE	ATE	0 986 481 057	23,81
			12.07→	72		JBH,LLE		0 986 480 886	23,8
	1.5 dCi	OFD	08.07-11.07	50/63/78		LLE	ATE	0 986 481 057	23,81
			12.07→	50/63/78		JBH,LLE		0 986 480 886	23,8
			11.10→	55/65		JBH,LLE		0 986 480 886	23,8





RENAULT Clio III Grandtour [KR]

	1.6	OFD	08.07-11.07	65/82/94	LLE	ATE	0 986 481 057	23,81	
			12.07→	65/82/94	JBH,LLE		0 986 480 886	23,8	
	1.2, TCe		08.07→	55/57,5/74			0 265 232 078 ^B		
	1.4		08.07→	72			0 265 232 078 ^B		
	1.5 dCi		08.07→		50			0 265 232 078 ^B	
				63		0 265 232 078 ^B			
				78		0 265 232 078 ^B			
		11.10→	55		0 265 232 078 ^B				
				65	TW	0 265 234 158 ^T			
					TW	0 265 232 078 ^B			
	1.6		08.07→	65/82			0 265 234 158 ^T		
							0 265 232 078 ^B		
	1.2, TCe		08.07→	55/57,5/74			0 265 005 263		
	1.4		08.07→	72			0 265 005 263		
	1.5 dCi		08.07→	50/55/63/65/78			0 265 005 263		
	1.6		08.07→	65/82/94			0 265 005 263		

Duster [HS]

	1.2		09.13→	92			0 265 230 752 ^T				
							0 265 232 385 ^B				
							1.5 dCi	09.13→	66	0 265 232 385 ^B	
										0 265 230 752 ^T	
							1.5 dCi 4x4	09.13→	80	0 265 230 752 ^T	
										0 265 232 387 ^B	
							1.5 dCi 4x4	03.12→	66	0 265 232 387 ^B	
										0 265 232 385 ^B	
							1.6	03.12→	75	0 265 232 385 ^B	
										09.13→	77
										0 265 232 387 ^B	
							1.6, 4x4	03.12→	75	0 265 230 752 ^T	
										0 265 232 387 ^B	
							1.6 4x4	03.12→	75	0 265 232 387 ^B	
										0 265 232 385 ^B	
							2.0	03.12→	99	0 265 232 385 ^B	
0 265 230 752 ^T											
2.0 4x4	03.12→	99	0 265 230 752 ^T								
			0 265 232 387 ^B								
	1.2		09.13→	92			0 265 005 811				
							1.5 dCi, dCi 4x4	03.12→	66/80	0 265 005 811	
										0 265 005 811	
							1.6, 4x4	03.12→	75/77	0 265 005 811	
2.0, 4x4	03.12→	99	0 265 005 811								

Espace II [J63]

	2.0 i	ABO	01.91-09.96	77		JBH	0 986 480 774	22,2						
							0 986 480 774	22,2						
							2.2 i, i 4x4	ABO	01.91-09.96	79-81	JBH	0 986 480 774	22,2	
												F 026 003 940	23,8	
							2.9 i		01.91-09.96	110-113	JBH			
	2.0 i		01.91-09.96	77		LLE	0 986 485 099							
							2.1 D Turbo	01.91-09.96	65	LLE	0 986 485 099			
											06.92-09.96	65	0 986 485 099	
											12.94-09.96	66	0 986 485 099	
							2.2 i, i 4x4		01.91-09.96	79-81		0 986 485 099		
	2.9 i		01.91-09.96	110-113			0 204 162 107							
							0 204 163 025							



	2.0i	01.91-09.96	77		NIV	0 204 131 288 ^A	
					NIV	0 204 131 290 ^A	
	2.1D Turbo	01.91-09.96	65/66		NIV	0 204 131 288 ^A	
					NIV	0 204 131 290 ^A	
	2.2i	01.91-09.96	79-81		NIV	0 204 131 288 ^A	
					NIV	0 204 131 290 ^A	
	2.2i 4x4				NIV	0 204 131 288 ^A	
	2.9i	01.91-09.96	110-113		NIV	0 204 131 288 ^A	
					NIV	0 204 131 290 ^A	

	2.0i	01.91-09.96	77			0 265 100 047 ^H	
	2.1D Turbo	01.91-09.96	65/66			0 265 100 047 ^H	
	2.2i	01.91-09.96	79-81			0 265 100 047 ^H	
	2.2i 4x4				AA	0 265 100 048 ^H	
	2.9i	01.91-09.96	110-113			0 265 100 047 ^H	

	2.2i, i 4x4	10.92-09.96	79-81		AA	0 265 005 038	
--	--------------------	-------------	-------	--	----	----------------------	--

Espace III [JE0]

	1.9 dTi	ABO	02.99-10.02	72		JBH	0 986 481 033	23,81
		ABS	02.99-10.02	72		JBH	0 986 480 921	23,81
	2.0i, i GPL	ABS	10.96-10.02	83,5		JBH	0 986 480 921	23,81
	2.0i, i GPL, i 16V	ABO	10.96-10.02	83,5/102-103		JBH	0 986 481 033	23,81
	2.0i 16V		07.00-10.02	102-103		JBH	0 986 480 921	23,81
		ABS	10.98-10.02	102-103		JBH	0 986 480 921	23,81
	2.2D Turbo	ABS	10.96-10.02	83		JBH	0 986 480 921	23,81
	2.2 dCi		07.00-10.02	85-95		JBH	0 986 480 921	23,81
	3.0i V6, i V6 24V	ABS	10.96-10.02	123/140		JBH	0 986 480 921	23,81

	1.9 dTi	02.99-10.02	72			0 265 216 727 ^H	
	2.0i	10.96-01.98	83,5			0 265 216 312 ^B	
		02.98-10.02	83,5			0 265 216 727 ^H	
	2.0i GPL	02.98-10.02	83,5			0 265 216 727 ^H	
	2.0i 16V	10.98-10.02	102-103			0 265 216 727 ^H	
	2.2D Turbo	10.96-01.98	83			0 265 216 312 ^B	
		02.98-10.02	83			0 265 216 727 ^H	
	2.2 dCi	07.00-10.02	85-95			0 265 216 727 ^H	
	3.0i V6	10.96-01.98	123			0 265 216 312 ^B	
		02.98-10.02	123			0 265 216 727 ^H	
3.0i V6 24V	10.98-10.02	140			0 265 216 727 ^H		

	1.9 dTi	02.99-10.02	72			1 273 004 406 ^H	
	2.0i, i GPL, i 16V	02.98-10.02	83,5/102-103			1 273 004 406 ^H	
	2.2D Turbo, dCi	02.98-10.02	83/85-95			1 273 004 406 ^H	
	3.0i V6, i V6 24V	02.98-10.02	123/140			1 273 004 406 ^H	

Espace IV [JK]

	1.9 dCi	11.02-12.06	88			0 986 486 596	27
	2.0, Turbo, 16V	11.02→	100-103/120			0 986 486 596	27
	2.0 Tce	06.04→	123-125		TW	0 986 486 596	27
	2.2 dCi	11.02-12.06	110			0 986 486 596	27

Express, Extra, Rapid [F40]

	Electrique	09.94-10.97	21		JBH	F 026 003 180	20,6
	1.1	09.91-09.96	36		JBH	BSY F 026 003 103	19
		09.91-10.97	36		JBH	BSY F 026 003 180	20,6



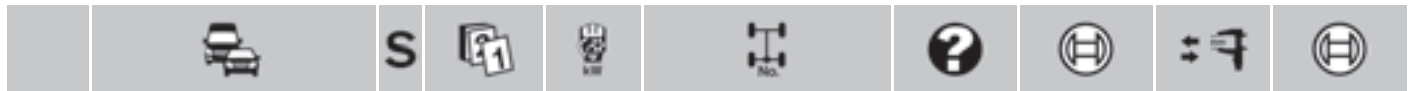

	◀ RENAULT Express, Extra, Rapid [F40]						
	1.2	09.91-09.96	40		JBH	F 026 003 180	20,6
	1.2 i	09.91-10.97	40		JBH,LLE	F 026 003 180	20,6
		10.96-10.97	40		JBH	F 026 003 180	20,6
	1.4	06.87-09.97	44		JBH BSY	F 026 003 103	19
		09.91-09.96	43		JBH,LLE ATE	F 026 003 180	20,6
		09.91-09.97	43		JBH	F 026 003 180	20,6
	1.4 i	09.91-03.97	44		JBH	F 026 003 180	20,6
		09.91-10.97	55-59		JBH,LLE ATE	F 026 003 180	20,6
					JBH	F 026 003 180	20,6
			03.96-09.97	55-59		JBH,LLE	F 026 003 180
	1.6 D	03.86-03.97	40		JBH BSY	F 026 003 103	19
						JBH	F 026 003 180
	1.9 D	09.91-03.97	40		JBH	F 026 003 180	20,6
		09.91-09.97	47-48		JBH BSY	F 026 003 103	19
					JBH	F 026 003 180	20,6
			09.91-10.97	47-48		JBH	F 026 003 180
		09.94-09.97	40		JBH,LLE	F 026 003 180	20,6

	Electrique	09.94-10.97	21			0 204 125 092		
	1.1	09.91-09.96	36			0 204 125 047		
					LLE	0 204 125 047		
					RLE	0 204 125 049		
						0 204 125 092		
		10.96-10.97	36			0 204 125 092		
	1.2	09.91-09.96	40		LLE	0 204 125 092		
	1.2 i	09.91-10.97	40		LLE	0 204 125 092		
			10.96-10.97	40			0 204 125 092	
	1.4	06.87-09.97	44			0 204 125 047		
		09.91-09.96	43		LLE	0 204 125 092		
				43			0 204 125 092	
	1.4 i	09.91-03.97	44		LLE	0 204 125 092		
			09.91-10.97	55-59			0 204 125 092	
					LLE	0 204 125 092		
	1.6 D	09.91-03.97	40		LLE	0 204 125 092		
	1.9 D	09.91-09.97	47-48		LLE	0 204 125 092		
			09.91-10.97	47-48			0 204 125 092	
			09.94-09.97	40		LLE	0 204 125 092	

	1.1	09.91-10.97	36			0 204 131 153^A	
	1.2, i	09.91-10.97	40			0 204 131 153^A	
	1.4	06.87-09.97	44			ATE	0 204 131 139^A
						2TO,ERH	0 204 131 154^A
		09.91-09.96	43		4TO,NON	0 204 131 153^A	
							0 204 131 154^A
	1.4 i	09.91-09.97	43			0 204 131 154^A	
		09.91-03.97	44			0 204 131 153^A	
				55-59		2TO,ERH	0 204 131 154^A
					4TO,NON	0 204 131 153^A	
	1.6 D	09.91-03.97	40		2TO,ERH	0 204 131 154^A	
					4TO,NON	0 204 131 153^A	
	1.9 D	09.91-10.97	40/47-48		2TO,ERH	0 204 131 154^A	
						4TO,NON	0 204 131 153^A

Fluence [L3]

		1.5 dCi	MFD 11.09→	63/66/70/78/81		0 204 701 709	
			OFD 11.09→	63/66/70/78/81		0 204 701 708	
		1.6	MFD 11.09→	81-85/96		0 204 701 709	
		1.6 dCi	OFD 11.09→	81-85/96		0 204 701 708	
		2.0	MFD 02.10→	103		0 204 701 709	
				OFD 02.10→	103		0 204 701 708



	1.5 dCi	MFD 11.09→	63/66/70/ 78/81	LLE	0 204 125 953	
				RLE	0 204 125 954	
		OFD 11.09→	63/66/70/ 78/81	LLE	0 204 125 951	
				RLE	0 204 125 952	
	1.6 1.6 dCi	MFD 11.09→	81-85/96	LLE	0 204 125 953	
				RLE	0 204 125 954	
		OFD 11.09→	81-85/96	LLE	0 204 125 951	
				RLE	0 204 125 952	
	2.0	MFD 02.10→	103	LLE	0 204 125 953	
				RLE	0 204 125 954	
		OFD 02.10→	103	LLE	0 204 125 951	
				RLE	0 204 125 952	

Grand Scenic II [JM]

	1.4 16V	05.03-04.09	72	BO	0 204 701 702	
				JBH TRW	0 986 481 002	23,81
	1.5 dCi	05.03-04.09	60/63/ 74-78	BO	0 204 701 702	
				JBH TRW	0 986 481 002	23,81
	1.6 16V	05.03-04.09	83	BO	0 204 701 702	
				JBH TRW	0 986 481 002	23,81
	1.9 dCi	05.03-04.09	81/88/96	BO	0 204 701 702	
				JBH TRW	0 986 481 002	23,81
	2.0 dCi, 16V, 16V Turbo	05.03-04.09	98-99/110/ 120	BO	0 204 701 702	
				JBH TRW	0 986 481 002	23,81

	1.4 16V	05.03-08.05	72		0 265 231 301 ^F		
		05.03-04.09	72		0 265 234 311 ^T		
		09.05-04.09	72		0 265 232 068 ^B		
	1.5 dCi	05.03-08.05	60		0 265 231 301 ^F		
			74-78		0 265 231 301 ^F		
		05.03-12.06	60		0 265 234 311 ^T		
			05.03-04.09	74-78		0 265 234 311 ^T	
		09.05-12.06	60		0 265 232 068 ^B		
			63		0 265 232 068 ^B		
					0 265 234 311 ^T		
		09.05-04.09	74-78		0 265 232 068 ^B		
		1.6 16V	05.03-08.05	83		0 265 231 301 ^F	
			05.03-04.09	83		0 265 234 311 ^T	
09.05-04.09	83			0 265 232 068 ^B			
				0 265 232 068 ^B			
	1.9 dCi	05.03-08.05	88		0 265 231 301 ^F		
			96		0 265 231 301 ^F		
		05.03-04.09	88		0 265 234 311 ^T		
			96		0 265 234 311 ^T		
		05.05-09.06	81		0 265 234 311 ^T		
			96		0 265 234 311 ^T		
		05.05-11.08	96		0 265 232 068 ^B		
		09.05-11.08	81		0 265 232 068 ^B		
		09.05-04.09	88		0 265 232 068 ^B		
			96		0 265 232 068 ^B		
10.06-11.08	81		0 265 234 680 ^T				
	96		0 265 234 680 ^T				
2.0 dCi	09.04-04.09	110		0 265 232 068 ^B			
				0 265 234 511 ^T			
		10.06-04.09	110		0 265 234 680 ^T		
2.0 16V	05.03-08.05	98-99		0 265 231 301 ^F			
	05.03-04.09	98-99		0 265 234 311 ^T			
	09.05-04.09	98-99		0 265 232 068 ^B			
2.0 16V Turbo	06.03-08.05	120		0 265 231 301 ^F			
	06.03-04.09	120		0 265 234 311 ^T			
	09.05-04.09	120		0 265 232 068 ^B			



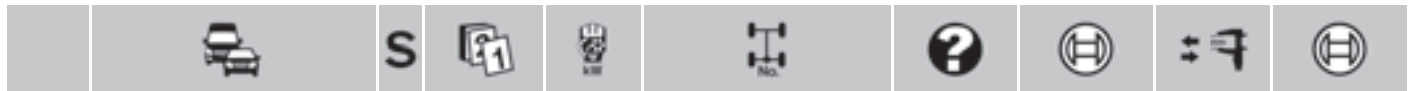

◀RENAULT Grand Scenic II [JM]

	1.4 16V	05.03-04.09	72		0 265 005 263	
	1.5 dCi	05.03-04.09	60/63/74-78		0 265 005 263	
	1.6 16V	05.03-04.09	83		0 265 005 263	
	1.9 dCi	05.03-04.09	81/88/96		0 265 005 263	
	2.0 dCi, 16V, 16V Turbo	05.03-04.09	98-99/110/120		0 265 005 263	

Grand Scenic III [JZ]

	1.6 dCi	03.11→	96		0 986 486 615	30
	1.9 dCi	05.09→	96		0 986 486 615	30











Kangoo I

	1.9 D	01.99-10.08	47		0 204 0A2 642	
--	-------	-------------	----	--	----------------------	--

Kangoo I [FC./KC.]

	1.0 i, i 16V	09.98-12.07	43/50		F 026 003 372	22
	1.2 GPL	ABO 10.97-12.07	44/55		F 026 003 372	22
	1.2 i	ABS 10.97-12.07	44/55	LLE	0 204 123 589	22,2
	1.2 i 16V			RLE	0 204 123 371	22,2
	1.4 i	ABO 10.97-12.07	55		F 026 003 372	22
		ABS 10.97-12.07	55	LLE	0 204 123 589	22,2
				RLE	0 204 123 371	22,2
	1.5 DCI	ABO 05.00-12.07	45/48/50/60/62		F 026 003 372	22
		ABS 05.00-12.07	45/48/50/60/62	LLE	0 204 123 589	22,2
				RLE	0 204 123 371	22,2
	1.6 i	09.99-12.07	66		F 026 003 372	22
		09.01-12.07	70		F 026 003 372	22
		ABO 06.00-12.07	70		F 026 003 372	22
	1.6 i	ABS 06.00-12.07	70	LLE	0 204 123 589	22,2
	1.6 i 4x4			RLE	0 204 123 371	22,2
	1.6 i 4x4	ABO 06.00-12.07	70		F 026 003 372	22
	1.9 D, DCI, DCI 4x4, DTI, DTI 4x4	ABO 10.97-12.07	40/47-48/59-62		F 026 003 372	22
		ABS 10.97-12.07	40/47-48/59-62	LLE	0 204 123 589	22,2
				RLE	0 204 123 371	22,2

	1.0 i, i 16V	09.98-12.07	43/50		0 204 125 763	0 204 120 023
	1.2 GPL	ABO 10.97-12.07	44/55	LLE	0 204 125 763	0 204 120 023
	1.2 i			RLE		0 204 120 023
	1.2 i 16V	ABS 10.97-12.07	44/55	LLE	0 204 125 786	0 204 120 023
				RLE	0 204 125 787	0 204 120 023
	1.4 i	ABO 10.97-12.07	55		0 204 125 763	0 204 120 023
		09.98-12.07	55	LLE	0 204 125 763	0 204 120 023
				RLE		0 204 120 023
		ABS 10.97-12.07	55		0 204 125 786	0 204 120 023
		09.98-12.07	55	LLE	0 204 125 786	0 204 120 023
				RLE	0 204 125 787	0 204 120 023
	1.5 DCI	ABO 05.00-12.07	45/48/50/60/62	LLE	0 204 125 763	0 204 120 023
				RLE		0 204 120 023
		ABS 05.00-12.07	45/48/50/60/62	LLE	0 204 125 786	0 204 120 023
				RLE	0 204 125 787	0 204 120 023
	1.6 i	09.99-12.07	66		0 204 125 763	0 204 120 023
		09.01-12.07	70		0 204 125 763	0 204 120 023
		ABO 06.00-12.07	70	LLE	0 204 125 763	0 204 120 023
	1.6 i	ABO 06.00-12.07	70	RLE		0 204 120 023
	1.6 i 4x4	ABS 06.00-12.07	70	LLE	0 204 125 786	0 204 120 023
				RLE	0 204 125 787	0 204 120 023

		S								
1.6 i 4x4	ABO	06.00-12.07	70			LLE	0 204 125 763		0 204 120 023	
1.9 D, DCI, DCI 4x4, DTI, DTI 4x4	ABO	10.97-12.07	40/47-48/ 59-62			LLE	0 204 125 763		0 204 120 023	
	ABS	10.97-12.07	40/47-48/ 59-62			RLE			0 204 120 023	
						LLE	0 204 125 786		0 204 120 023	
						RLE	0 204 125 787		0 204 120 023	
 1.0 i, i 16V		09.98-12.07	43/50				0 204 131 387 ^A			
	1.2 GPL		10.97-01.98	44				0 204 031 306 ^A		
			02.98-12.07	44				0 204 131 387 ^A		
	1.2 i		10.97-01.98	44				0 204 031 306 ^A		
			02.98-12.07	44				0 204 131 387 ^A		
			09.98-12.07	44			LLE	0 204 031 306 ^A		
							RLE	0 204 131 387 ^A		
			03.02-12.07	44			ERH,LLE	0 204 031 307 ^A		
							ERH,RLE	0 204 131 388 ^A		
						LLE,NON	0 204 031 306 ^A			
					NON,RLE	0 204 131 387 ^A				
1.2 i 16V		05.00-12.07	55			ERH,LLE	0 204 031 307 ^A			
						ERH,RLE	0 204 131 388 ^A			
						LLE,NON	0 204 031 306 ^A			
						NON,RLE	0 204 131 387 ^A			
1.4 i		10.97-12.07	55			ERH	0 204 031 307 ^A			
						NON	0 204 031 306 ^A			
		09.98-12.07	55			ERH,LLE	0 204 031 307 ^A			
						ERH,RLE	0 204 131 388 ^A			
1.5 DCI						LLE,NON	0 204 031 306 ^A			
						NON,RLE	0 204 131 387 ^A			
		05.00-12.07	45/48/50/ 60/62			ERH,LLE	0 204 031 307 ^A			
						ERH,RLE	0 204 131 388 ^A			
1.6 i						LLE,NON	0 204 031 306 ^A			
						NON,RLE	0 204 131 387 ^A			
		09.99-12.07	66				0 204 131 387 ^A			
		06.00-12.07	70			ERH,LLE	0 204 031 307 ^A			
						LLE,NON	0 204 031 306 ^A			
						NON,RLE	0 204 131 387 ^A			
		09.01-12.07	70	Fg.-Nr. KCOR, Fg.-Nr. FCOR			0 204 131 387 ^A			
		01.03-12.07	70		ERH	0 204 031 307 ^A				
					NON	0 204 031 306 ^A				
1.6 i, i 4x4		06.00-12.07	70			ERH,RLE	0 204 131 388 ^A			
1.6 i 4x4						ERH,LLE	0 204 031 307 ^A			
						LLE,NON	0 204 031 306 ^A			
						NON,RLE	0 204 131 387 ^A			
1.9 D		10.97-01.98	40				0 204 031 306 ^A			
			47-48			ERH	0 204 031 307 ^A			
		01.98-12.07	47			ERH,LLE	0 204 031 307 ^A			
						ERH,RLE	0 204 131 388 ^A			
						LLE,NON	0 204 031 306 ^A			
						NON,RLE	0 204 131 387 ^A			
			47-48			ERH,LLE	0 204 031 307 ^A			
						ERH,RLE	0 204 131 388 ^A			
						LLE,NON	0 204 031 306 ^A			
						NON,RLE	0 204 131 387 ^A			
		02.98-12.07	40				0 204 131 387 ^A			
			47-48			ERH	0 204 131 388 ^A			
						NON	0 204 131 387 ^A			
1.9 DCI		09.98-12.07	59-62			ERH,LLE	0 204 031 307 ^A			
1.9 DCI 4x4						ERH,RLE	0 204 131 388 ^A			
1.9 DTI						LLE,NON	0 204 031 306 ^A			
1.9 DTI 4x4						NON,RLE	0 204 131 387 ^A			
 1.0 i, i 16V		04.03-12.07	43/50				0 265 232 372 ^B			



		S							
◀ RENAULT Kangoo I [FC./KC.]									
1.2 GPL	01.99-05.99	44					0 265 216 691 ^B		
	06.99-06.00	44					0 265 216 741 ^B		
	07.00-03.03	44					0 265 216 881 ^B		
1.2 GPL	10.97-12.98	44					0 265 216 481 ^B		
1.2 i	04.03-12.07	44					0 265 232 372 ^B		
1.2 i	09.98-05.99	44					0 265 216 691 ^B		
	06.99-06.00	44					0 265 216 741 ^B		
	07.00-03.03	44					0 265 216 881 ^B		
	03.02-03.03	44				LLE	0 265 216 881 ^B		
						RLE	0 265 216 741 ^B		
1.2 i 16V	05.00-03.03	55				RLE	0 265 216 741 ^B		
	07.00-03.03	55				LLE	0 265 216 881 ^B		
	04.03-12.07	55					0 265 232 372 ^B		
1.4 i	10.97-12.98	55					0 265 216 481 ^B		
	09.98-05.99	55					0 265 216 691 ^B		
	06.99-06.00	55					0 265 216 741 ^B		
	06.00-03.03	55				RLE	0 265 216 741 ^B		
	07.00-03.03	55					0 265 216 881 ^B		
						LLE	0 265 216 881 ^B		
1.5 DCI	04.03-12.07	55					0 265 232 372 ^B		
	05.00-03.03	48				LLE	0 265 216 881 ^B		
						RLE	0 265 216 741 ^B		
	02.01-03.03	60				LLE	0 265 216 881 ^B		
						RLE	0 265 216 741 ^B		
	04.03-12.07	48					0 265 232 372 ^B		
1.6 i		60					0 265 232 372 ^B		
	04.05-12.07	45					0 265 232 372 ^B		
		50					0 265 232 372 ^B		
		62					0 265 232 372 ^B		
	06.00-03.03	70				RLE	0 265 216 741 ^B		
	07.00-03.03	70				LLE	0 265 216 881 ^B		
1.6 i 4x4	04.03-12.07	66					0 265 232 372 ^B		
		70					0 265 232 372 ^B		
	06.00-03.02	70					0 265 220 601 ^B		
1.9 D	04.02-12.07	70					0 265 220 667 ^B		
	10.97-12.98	40					0 265 216 481 ^B		
		47-48					0 265 216 481 ^B		
	01.98-05.99	47-48				LLE	0 265 216 691 ^B		
	01.98-03.03	47-48				RLE	0 265 216 741 ^B		
	01.99-05.99	40					0 265 216 691 ^B		
		47-48					0 265 216 691 ^B		
	06.99-06.00	40					0 265 216 741 ^B		
		47-48					0 265 216 741 ^B		
						LLE	0 265 216 741 ^B		
	07.00-03.03	40					0 265 216 881 ^B		
		47				LLE	0 265 216 881 ^B		
		47-48					0 265 216 881 ^B		
						LLE	0 265 216 881 ^B		
	04.03-12.07	40					0 265 232 372 ^B		
	47					0 265 232 372 ^B			
	47-48					0 265 232 372 ^B			
1.9 DCI	05.00-03.03	59-62				RLE	0 265 216 741 ^B		
	07.00-03.03	59-62				LLE	0 265 216 881 ^B		
	04.03-12.07	59-62					0 265 232 372 ^B		
1.9 DCI 4x4	05.00-03.02	59-62					0 265 220 601 ^B		
	04.02-12.07	59-62					0 265 220 667 ^B		
1.9 DTI	09.98-05.99	59					0 265 216 691 ^B		
	06.99-06.00	59					0 265 216 741 ^B		
	02.00-03.02	59					0 265 220 601 ^B		
	07.00-03.03	59					0 265 216 881 ^B		
	04.03-12.07	59					0 265 232 372 ^B		
1.9 DTI, DTI 4x4	04.02-12.07	59					0 265 220 667 ^B		
1.9 DTI 4x4	05.00-03.02	59					0 265 220 601 ^B		





Kangoo II [Fase II]

	1.6 i 16V	01.02-12.12	81		F 026 003 372 0 204 0A2 642	22
	1.6 i 16V	01.02-12.12	81		0 204 125 763	0 204 120 023
	1.6 i 16V	01.02-12.12	81		0 204 131 387^A	

Kangoo II [FW/KW]

	1.2	ABO 09.13→	84		0 204 123 760	22,2
		ABS 09.13→	84		0 204 123 759	22,2
	1.5 dCi	ABO 01.08→	50/55/63/66/76/78/80/81		0 204 123 760	22,2
	1.5 DCI	ABS 01.08→	50/55/63/66/76/78/80/81		0 204 123 759	22,2
	1.6	ABO 01.08→	64/72/78		0 204 123 760	22,2
	1.6 16V	ABS 01.08→	64/72/78		0 204 123 759	22,2
	1.2	09.13→	84	TW	0 265 232 755^B	
	1.5 dCi	02.13→	81		0 265 232 755^B	
	1.5 DCI	01.08→	80	TW	0 265 232 755^B	
		03.11→	80		0 265 232 755^B	
	1.5 dCi, DCI	01.08→	50/55/63/66/76/78	TW	0 265 232 755^B	
	1.6, 16V	01.08→	64/72/78	TW	0 265 232 755^B	
	1.2	09.13→	84		0 265 005 811	
	1.5 dCi	03.11→	66		0 265 005 811	
		02.13→	81		0 265 005 811	
	1.5 DCI	01.08-10.08	50		0 265 005 701	
			63		0 265 005 701	
			76/78/80		0 265 005 701	
		11.08→	50		0 265 005 811	
			63		0 265 005 811	
			76/78/80		0 265 005 811	
		03.11→	55		0 265 005 811	
	1.6	01.08-10.08	64/72/78		0 265 005 701	
	1.6 16V	11.08→	64/72/78		0 265 005 811	

Koleos [HY]

	2.0 dCi	09.08→	110	LLE	0 204 053 219	
		09.13→	127	LLE	0 204 053 219	
		MFD 09.08→	110	RLE	0 204 053 216	
		OFD 09.08→	110	RLE	0 204 053 217	
	2.0 dCi	MFD 09.08→	127	RLE	0 204 053 216	
	2.0 dCi 4x4	OFD 09.08→	127	RLE	0 204 053 217	
	2.0 dCi 4x4	09.08→	110	LLE	0 204 053 221	
			127	LLE	0 204 053 218	
		MFD 09.08→	110	RLE	0 204 053 214	
		OFD 09.08→	110	RLE	0 204 053 215	
	2.5	09.08→	126	LLE	0 204 053 218	
	2.5 4x4	MFD 09.08→	126	RLE	0 204 053 216	
		OFD 09.08→	126	RLE	0 204 053 217	



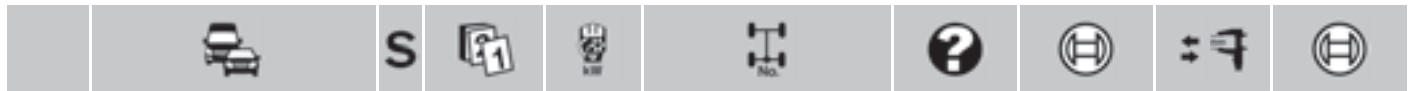

◀ RENAULT

Laguna I [B56]



	1.6 i 16V	05.98-01.99	79		0 204 123 155	23,8	
		09.99-02.01	79	JBH	F 026 003 940	23,8	
	ABS	02.99-02.01	79	JBH	F 026 003 940	23,8	
	1.8 GPL	ABS	02.97-01.99	66-70	0 204 123 155	23,8	
	1.8 GPL	ABO	01.94-03.01	66-70	JBH	0 986 480 908	22
	1.8 i	ABS	01.94-01.97	66-70	JBH	0 986 480 955	23,81
		02.99-02.01	66-70	JBH	F 026 003 940	23,8	
	1.8 i	ABS	02.97-03.01	66-70		0 204 123 155	23,8
	1.8 i 16V	05.98-01.99	88		0 204 123 155	23,8	
		02.99-02.01	88	JBH	F 026 003 940	23,8	
	1.9 DCI		09.99-02.01	80	JBH	F 026 003 940	23,8
	1.9 DTI		10.97-01.99	72		0 204 123 155	23,8
		02.99-02.01	72	JBH	F 026 003 940	23,8	
	2.0 i		01.99-01.99	83-85		0 204 123 155	23,8
		02.99-02.01	83-85	JBH	F 026 003 940	23,8	
		ABO	01.94-02.01	83-85		0 204 123 155	23,8
		ABS	01.94-01.97	83-85	JBH	0 986 480 955	23,81
		02.97-02.01	83-85		0 204 123 155	23,8	
		02.99-02.01	83-85	JBH	F 026 003 940	23,8	
	2.0 i 16V	ABO	09.95-02.01	102		0 204 123 155	23,8
		ABS	09.95-01.97	102	JBH	0 986 480 955	23,81
		02.97-02.01	102		0 204 123 155	23,8	
	2.2 D	ABO	01.94-02.01	61-63	JBH	0 986 480 908	22
		ABS	01.94-01.97	61-63	JBH	0 986 480 955	23,81
		02.97-02.01	61-63		0 204 123 155	23,8	
	2.2 D Turbo	ABO	02.96-02.01	83-85		0 204 123 155	23,8
		ABS	02.96-01.97	83-85	JBH	0 986 480 955	23,81
		02.97-01.99	83-85		0 204 123 155	23,8	
		02.99-02.01	83-85	JBH	F 026 003 940	23,8	
		3.0 i		01.94-02.01	123-125	JBH	0 986 480 955
	ABS	06.94-01.97	123-125	JBH	0 986 480 955	23,81	
		02.97-02.01	123-125		0 204 123 155	23,8	
	3.0 i 24V		03.97-01.99	143		0 204 123 155	23,8
		02.99-02.01	143	JBH	F 026 003 940	23,8	

	1.6 i 16V	05.98-02.01	79	BSY		0 204 120 023
				LLE	0 204 125 119	
	1.8 GPL	ABS	02.97-02.01	66-70	LLE	0 204 125 119
	1.8 GPL, i		01.94-03.01	66-70	BSY	0 204 120 023
	1.8 i	ABS	02.97-03.01	66-70		0 204 125 119
					LLE	0 204 125 119
	1.8 i 16V	05.98-02.01	88		BSY	0 204 120 023
				LLE	0 204 125 119	
	1.9 DCI		10.97-02.01	72/80	BSY	0 204 120 023
	1.9 DTI				LLE	0 204 125 119
	2.0 i		01.94-02.01	83-85	BSY	0 204 120 023
		02.97-02.01	83-85	LLE	0 204 125 119	
		ABO	01.94-02.01	83-85		0 204 125 119
		ABS	02.97-02.01	83-85		0 204 125 119
	2.0 i 16V		09.95-02.01	102	BSY	0 204 120 023
		02.97-02.01	102	LLE	0 204 125 119	
		ABO	09.95-02.01	102	LLE	0 204 125 119
	2.2 D		01.94-02.01	61-63	BSY	0 204 120 023
		ABS	02.97-02.01	61-63		0 204 125 119
					LLE	0 204 125 119
	2.2 D Turbo		02.96-02.01	83-85	BSY	0 204 120 023
		02.97-02.01	83-85	LLE	0 204 125 119	
	3.0 i		01.94-02.01	123-125/143	BSY	0 204 120 023
		02.97-02.01	123-125/143	LLE	0 204 125 119	

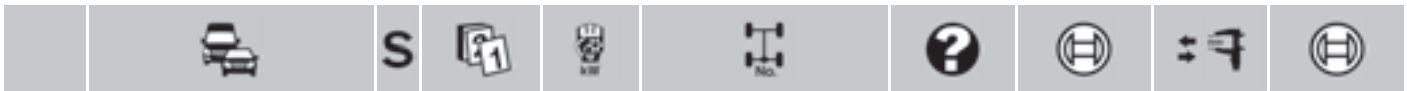

	1.8 GPL	09.95-02.01	66-70		0 204 131 168	
	1.8 i	09.95-03.01	66-70		0 204 131 168	
	ABO	01.94-03.01	66-70		0 204 131 168	
	ABS	01.94-04.95	66-70		0 204 131 165	
		05.95-01.97	66-70		0 204 131 168	
	2.0 i	01.94-01.97	83-85	NFS	0 204 131 165	
		09.95-02.01	83-85	NFS	0 204 131 168	
		01.96-02.01	83-85		0 204 131 168	
	ABO	01.94-02.01	83-85		0 204 131 168	
	ABS	01.94-04.95	83-85		0 204 131 166	
				NFS	0 204 131 166	
		05.95-12.96	83-85		0 204 131 168	
		05.95-01.97	83-85	NFS	0 204 131 168	
	2.0 i 16V	09.95-02.01	102		0 204 131 167	
	2.2 D	09.95-02.01	61-63		0 204 131 168	
	ABO	01.94-10.95	61-63		0 204 131 168	
	ABS	01.94-04.95	61-63		0 204 131 165	
		05.95-10.95	61-63		0 204 131 168	
	2.2 D Turbo	02.96-02.01	83-85		0 204 131 166	
	3.0 i	01.94-02.01	123-125		0 204 131 167	

Laguna I Grandtour [A56]

	2.0 i 16V	09.99-02.01	100	JBH	F 026 003 940	23,8
	2.0 i 16V	09.99-02.01	100	LLE	0 204 125 119	

Laguna I Grandtour [K56]

	1.6 i 16V	05.98-01.99	79		0 204 123 155	23,8
		02.99-02.01	79	JBH	F 026 003 940	23,8
	1.8 GPL	ABO 09.95-02.01	66-70		0 204 123 155	23,8
		ABS 02.97-01.99	66-70		0 204 123 155	23,8
		02.99-02.01	66-70	JBH	F 026 003 940	23,8
	1.8 GPL, i	ABS 09.95-01.97	66-70	JBH	0 986 480 955	23,81
	1.8 i	ABO 09.95-02.01	66-70		0 204 123 155	23,8
		ABS 02.97-02.01	66-70		0 204 123 155	23,8
	1.8 i 16V	05.98-01.99	88		0 204 123 155	23,8
		02.99-02.01	88	JBH	F 026 003 940	23,8
	1.9 DCI	09.99-02.01	80	JBH	F 026 003 940	23,8
	1.9 DTI	10.97-01.99	72		0 204 123 155	23,8
		02.99-02.01	72	JBH	F 026 003 940	23,8
	2.0 i	09.95-02.01	83-85	JBH	0 986 480 955	23,81
		ABO 09.95-02.01	83-85		0 204 123 155	23,8
		ABS 09.95-01.97	83-85	JBH	0 986 480 955	23,81
		02.97-02.01	83-85		0 204 123 155	23,8
		02.99-02.01	83-85	JBH	F 026 003 940	23,8
	2.0 i 16V	ABO 09.95-02.01	102		0 204 123 155	23,8
		ABS 09.95-02.01	102	JBH	0 986 480 955	23,81
		02.97-01.99	102		0 204 123 155	23,8
		02.99-02.01	102	JBH	F 026 003 940	23,8
	2.2 D	ABO 02.95-02.01	61-63		0 204 123 155	23,8
		11.96-02.01	61-63	BSY	0 204 123 155	23,8
		ABS 02.95-01.97	61-63	JBH	0 986 480 955	23,81
		02.97-02.01	61-63		0 204 123 155	23,8
	2.2 D Turbo	ABO 02.96-02.01	83-85		0 204 123 155	23,8
		ABS 02.96-01.97	83-85	JBH	0 986 480 955	23,81



		S							
RENAULT Laguna I Grandtour [K56]									
2.2 D Turbo	ABS	02.97-01.99	83-85				0 204 123 155	23,8	
		02.99-02.01	83-85		JBH		F 026 003 940	23,8	
3.0 i	ABS	03.96-02.01	123-125			JBH	0 986 480 955	23,81	
		11.96-01.97	123-125		JBH		0 986 480 955	23,81	
3.0 i 24V		02.97-02.01	123-125				0 204 123 155	23,8	
		03.97-01.99	143				0 204 123 155	23,8	
3.0 i 24V		02.99-02.01	143		JBH		F 026 003 940	23,8	
1.6 i 16V		05.98-02.01	79		LLE		0 204 125 119		
1.8 GPL		02.97-02.01	66-70		LLE		0 204 125 119		
1.8 i		02.97-02.01	66-70		LLE		0 204 125 119		
	ABO	09.95-02.01	66-70				0 204 125 119		
	ABS	02.97-02.01	66-70				0 204 125 119		
1.8 i 16V		05.98-02.01	88		LLE		0 204 125 119		
1.9 DCI, DTI		10.97-02.01	72/80		LLE		0 204 125 119		
2.0 i		09.95-02.01	83-85				0 204 125 119		
		02.97-02.01	83-85		LLE		0 204 125 119		
	ABO	09.95-02.01	83-85				0 204 125 119		
2.0 i 16V	ABS	02.97-02.01	83-85				0 204 125 119		
		02.97-02.01	102		LLE		0 204 125 119		
2.2 D	ABO	09.95-02.01	102		LLE		0 204 125 119		
		02.97-02.01	61-63		LLE		0 204 125 119		
2.2 D Turbo	ABS	02.95-02.01	61-63				0 204 125 119		
		06.95-10.95	61-63		LLE		0 204 125 119		
		02.97-02.01	61-63				0 204 125 119		
3.0 i		02.97-02.01	83-85		LLE	0 204 125 119			
3.0 i 24V		02.97-02.01	123-125		LLE		0 204 125 119		
3.0 i 24V		03.97-02.01	143				0 204 125 119		
1.8 GPL	ABO	09.95-02.01	66-70		NIV		0 204 131 175		
					NIV		0 204 131 094		
1.8 GPL	ABS	06.96-01.97	66-70		NIV		0 204 131 175		
					NIV		0 204 131 094		
1.8 GPL	ABS	09.95-05.96	66-70		NIV		0 204 131 185		
1.8 i					NIV		0 204 131 095		
1.8 i	ABO	09.95-02.01	66-70		NIV		0 204 131 175		
					NIV		0 204 131 094		
		06.96-01.97	66-70		NIV		0 204 131 175		
2.0 i	ABS	09.95-02.01	66-70		NIV		0 204 131 094		
					NIV		0 204 131 175		
		06.96-01.97	66-70		NIV		0 204 131 094		
2.0 i	ABO	09.95-02.01	83-85		NIV		0 204 131 175		
					NIV		0 204 131 094		
		09.95-05.96	83-85		NIV		0 204 131 185		
2.0 i 16V	ABS	06.96-01.97	83-85		NIV		0 204 131 175		
					NIV		0 204 131 094		
		09.95-02.01	102		NIV		0 204 131 185		
2.2 D	ABO	09.95-02.01	102		NIV		0 204 131 095		
					NIV		0 204 131 185		
		11.96-02.01	61-63		NIV		0 204 131 175		
2.2 D Turbo	ABS	02.95-02.01	61-63		NIV		0 204 131 175		
					NIV		0 204 131 094		
		02.95-05.96	61-63		NIV		0 204 131 176		
2.2 D Turbo	ABS	02.95-05.96	61-63		NIV		0 204 131 095		
					NIV		0 204 131 175		
		06.96-01.97	61-63		NIV		0 204 131 175		
2.2 D Turbo	ABS	06.96-01.97	61-63		NIV		0 204 131 094		
					NIV		0 204 131 185		
		02.96-02.01	83-85		NIV		0 204 131 095		
3.0 i		03.96-02.01	123-125		NIV		0 204 131 185		
					NIV		0 204 131 095		



Laguna I Grandtour [S56]

	1.9 DTI	03.98-01.99	72			0 204 123 155	23,8
		02.99-02.01	72	JBH		F 026 003 940	23,8
	2.2 D	ABO 02.95-02.01	61-63			0 204 123 155	23,8
		ABS 02.95-01.97	61-63	JBH		0 986 480 955	23,81
		02.97-02.01	61-63			0 204 123 155	23,8
	2.2 D Turbo	ABO 02.96-02.01	83-85			0 204 123 155	23,8
ABS 02.96-01.97		83-85	JBH		0 986 480 955	23,81	
<hr/>							
	1.9 DTI	03.98-02.01	72			0 204 125 119	
	2.2 D	ABO 02.95-02.01	61-63			0 204 125 119	
		ABS 02.97-02.01	61-63			0 204 125 119	
	2.2 D Turbo	ABO 02.96-02.01	83-85			0 204 125 119	
		ABS 02.97-02.01	83-85			0 204 125 119	
<hr/>							
	1.9 DTI	ABO 03.98-02.01	72			0 204 131 175	
	2.2 D	11.95-02.01	61-63			0 204 131 175	
		ABO 02.95-10.95	61-63			0 204 131 175	
		09.95-02.01	61-63	LWG		0 204 131 175	
					NIV	0 204 131 175	
					NIV	0 204 131 094	
		ABS 02.95-05.96	61-63			0 204 131 176	
		09.95-05.96	61-63			0 204 131 176	
					NIV	0 204 131 095	
		06.96-01.97	61-63			0 204 131 175	
					NIV	0 204 131 094	
	2.2 D Turbo	02.96-02.01	83-85			0 204 131 175	
		ABS 02.96-05.96	83-85			0 204 131 176	

Laguna I [556]

	2.0 i 16V	09.99-02.01	100	JBH		F 026 003 940	23,8
<hr/>							
	2.0 i 16V	09.99-02.01	100		BSY		0 204 120 023
				LLE		0 204 125 119	

Laguna II [BG.]

	1.6 16V	03.01-04.05	79/82	JBH		0 986 481 032	23,81
	1.8 16V	03.01-04.05	85/88	JBH		0 986 481 032	23,81
	1.9 DCI	03.01-04.05	68/74/81/88/96	JBH		0 986 481 032	23,81
	2.0 DCI, T, 16V, 16V IDE	03.01-04.05	99/103/110/120-125/150	JBH		0 986 481 032	23,81
	2.2 DCI	03.01-04.05	110	JBH		0 986 481 032	23,81
	3.0 V6 24V	03.01-04.05	152	JBH		0 986 481 032	23,81

Laguna II Grandtour [KG.]

	1.6 16V	03.01-04.05	79/82	JBH		0 986 481 032	23,81
	1.8 16V	03.01-04.05	85/88/89	JBH		0 986 481 032	23,81
	1.9 DCI	03.01-04.05	68/74-79/81/88/96	JBH		0 986 481 032	23,81
	2.0 DCI, T, 16V, 16V IDE	03.01-04.05	99/103/110/120/150	JBH		0 986 481 032	23,81
	2.2 DCI	03.01-04.05	110	JBH		0 986 481 032	23,81
	3.0 V6 24V	03.01-04.05	152	JBH		0 986 481 032	23,81





◀ RENAULT

Laguna III [BT]



	1.5 dCi	07.07→	47-81		0 204 123 761	23,81
	1.6	10.07→	83		0 204 123 761	23,81
	2.0, dCi, TCe	10.07→	96/103/110/125/127/131/150		0 204 123 761	23,81
	3.0 dCi	02.08→	173		0 204 123 761	23,81
	3.5	02.08→	175		0 204 123 761	23,81

	1.5 dCi	MFD 07.07→	47-81	LLE	0 204 125 892	
				RLE	0 204 125 894	
		OFD 07.07→	47-81	LLE	0 204 125 891	
				RLE	0 204 125 893	
	1.6	MFD 10.07→	83	LLE	0 204 125 892	
				RLE	0 204 125 894	
		OFD 10.07→	83	LLE	0 204 125 891	
				RLE	0 204 125 893	
	2.0	MFD 10.07→	96/103/110/125/ 127/131/150	LLE	0 204 125 892	
				RLE	0 204 125 894	
	2.0 dCi	OFD 10.07→	96/103/110/125/ 127/131/150	LLE	0 204 125 891	
				RLE	0 204 125 893	
	2.0 TCe	MFD 02.08→	173	LLE	0 204 125 892	
				RLE	0 204 125 894	
	3.0 dCi	OFD 02.08→	173	LLE	0 204 125 891	
				RLE	0 204 125 893	
	3.5	MFD 02.08→	175	LLE	0 204 125 892	
				RLE	0 204 125 894	
		OFD 02.08→	175	LLE	0 204 125 891	
				RLE	0 204 125 893	

Laguna III Coupé [DT]



	1.5 dCi	01.13→	81		0 204 123 761	23,81
	2.0 dCi, TCe	02.08→	110/125/127/131/150		0 204 123 761	23,81
	3.0 dCi	02.08→	173		0 204 123 761	23,81
	3.5	02.08→	175		0 204 123 761	23,81

	1.5 dCi	MFD 01.13→	81	LLE	0 204 125 892	
				RLE	0 204 125 894	
		OFD 01.13→	81	LLE	0 204 125 891	
				RLE	0 204 125 893	
	2.0 dCi	MFD 02.08→	110/125/127/ 131/150	LLE	0 204 125 892	
				RLE	0 204 125 894	
	2.0 TCe	OFD 02.08→	110/125/127/ 131/150	LLE	0 204 125 891	
				RLE	0 204 125 893	
	3.0 dCi	MFD 02.08→	173	LLE	0 204 125 892	
				RLE	0 204 125 894	
		OFD 02.08→	173	LLE	0 204 125 891	
				RLE	0 204 125 893	
3.5	MFD 02.08→	175	LLE	0 204 125 892		
			RLE	0 204 125 894		
	OFD 02.08→	175	LLE	0 204 125 891		
			RLE	0 204 125 893		

Laguna III Grandtour [KT]



	1.5 dCi	07.07→	81		0 204 123 761	23,81
	1.6	10.07→	83		0 204 123 761	23,81
	2.0, dCi, TCe	10.07→	96/103/110/125/127/131/150		0 204 123 761	23,81

		S							
3.0 dCi		02.08→	173					0 204 123 761	23,81
3.5		02.08→	175					0 204 123 761	23,81
	1.5 dCi	MFD 07.07→	81			LLE		0 204 125 892	
						RLE		0 204 125 894	
		OFD 07.07→	81			LLE		0 204 125 891	
						RLE		0 204 125 893	
1.6	MFD 10.07→		83			LLE		0 204 125 892	
						RLE		0 204 125 894	
		OFD 10.07→	83			LLE		0 204 125 891	
						RLE		0 204 125 893	
2.0	MFD 10.07→		96/103/110/125/			LLE		0 204 125 892	
2.0 dCi			127/131/150			RLE		0 204 125 894	
2.0 TCe	OFD 10.07→		96/103/110/125/			LLE		0 204 125 891	
			127/131/150			RLE		0 204 125 893	
3.0 dCi	MFD 02.08→		173			LLE		0 204 125 892	
						RLE		0 204 125 894	
		OFD 02.08→	173			LLE		0 204 125 891	
						RLE		0 204 125 893	
3.5	MFD 02.08→		175			LLE		0 204 125 892	
						RLE		0 204 125 894	
		OFD 02.08→	175			LLE		0 204 125 891	
						RLE		0 204 125 893	

Logan [LS]

	1.4	ABS 07.04-07.07	55			JBH		0 986 480 852	20,6
	1.5 dCi	ABS 06.05-07.07	48/50/63			JBH		0 986 480 852	20,6
	1.6, 16V	ABS 07.04-07.07	64/77			JBH		0 986 480 852	20,6
	1.6 16V	ABS 04.07-07.07	80			JBH		0 986 480 852	20,6
	1.6 16V Hi-Flex	ABS 07.07-03.08	79-82			JBH		0 986 480 852	20,6
	1.2		09.11→	55				0 265 232 719 ^B	
	1.4		07.04→	55				0 265 232 719 ^B	
	1.5 dCi		06.05→	48/50/63				0 265 232 719 ^B	
	1.6, 16V		07.04→	64/77				0 265 232 719 ^B	
	1.6 16V		04.07-12.12	80				0 265 232 719 ^B	
	1.6 16V Hi-Flex		07.07-11.13	79-82				0 265 232 111 ^B	

Logan MCV [KS/FS]

	1.4	ABS 01.07-02.07	55			JBH		0 986 481 001	22,2
	1.5 dCi	ABS 01.07-02.07	50/63			JBH		0 986 481 001	22,2
	1.6, 16V	ABS 01.07-02.07	64/77			JBH		0 986 481 001	22,2
	1.4	01.07-02.07	55					0 265 232 719 ^B	
		03.07→	55					0 265 232 111 ^B	
	1.5 dCi	01.07-02.07	50/63					0 265 232 719 ^B	
		03.07→	50/63					0 265 232 111 ^B	
	1.6	01.07-02.07	64/77					0 265 232 719 ^B	
	1.6 16V	03.07→	64/77					0 265 232 111 ^B	

Mascott

	90		01.99-06.04	63		35T,JBH		F 026 003 140	25,4	
	110, .60		01.99-06.04	78		35T,JBH		F 026 003 140	25,4	
	120		05.04-05.07	85		35T,JBH		F 026 003 140	25,4	
	130		01.99-06.04	92			35T,JBH		F 026 003 140	25,4
			06.07-12.10	96			35T,JBH,LLE		F 026 003 140	25,4



		S							
RENAULT Mascott									
	140	01.01-06.04	103		35T,JBH	F 026	003 140	25,4	
	150	10.01-06.04	107		35T,JBH	F 026	003 140	25,4	
		06.07-12.10	110		35T,JBH,LE	F 026	003 140	25,4	
	160	05.04-05.07	115		35T,JBH	F 026	003 140	25,4	
	90	01.99-06.04	63		35T	0 204	021 576		
					56T	0 204	021 584^S		
	110	01.99-06.04	78		35T	0 204	021 576		
	110.60				56T	0 204	021 584^S		
	120	05.04-05.07	85		35T	0 204	021 576		
					56T	0 204	051 183^S		
	130	01.99-06.04	92		35T	0 204	021 576		
					56T	0 204	021 584^S		
		06.07-12.10	96		RLE	0 204	051 704^S		
					35T,LE	0 204	051 706^S		
						0 204	125 948		
					56T,LE	0 204	051 704^S		
	140	01.01-06.04	103		35T	0 204	021 576		
					56T	0 204	021 584^S		
	150	10.01-06.04	107		35T	0 204	021 576		
					56T	0 204	021 584^S		
		06.07-12.10	110		RLE	0 204	051 704^S		
					35T,LE	0 204	051 706^S		
						0 204	125 948		
					56T,LE	0 204	051 704^S		
	160	05.04-05.07	115		35T	0 204	021 576		
					56T	0 204	051 183^S		
	130	06.07-12.10	96			0 265	233 030^B		
	150	06.07-12.10	110			0 265	233 030^B		
Master [ADCU]									
	2.5 dCi 16V	ABO	10.04-02.12	85		0 204	123 651	23,8	
		ABS	10.04-02.12	85		0 204	123 634	23,8	
	2.5 dCi 16V	ABO	10.04-02.12	85		0 204	125 819		0 204 120 023
		ABS	10.04-02.12	85		0 204	125 811		0 204 120 023
	2.5 dCi 16V		10.04-02.12	85	Get.-Nr. PK5 016,017,018→, GS PK5 019,020,021→, PK5 022,023,071→, PK6 019,020,029→, PK6 030,069,070→, PK6 079,080→	0986	486 596	27	
Master I									
	P28 -35		10.86-09.97	63		JBH	0986	480 636	22,2
	T28 -35		09.80-09.97	44/52-55/57-59/ 67/69/72		JBH	0986	480 636	22,2
	T28 -35D								
	P28 -35	ABS	10.86-09.97	63		0 204	125 811		0 204 120 023
	T28 -35	ABS	09.80-09.97	44/52-55/57-59/ 67/69/72		0 204	125 811		0 204 120 023
	T28 -35D								
	P28 -35		10.86-09.97	63		0986	486 596	27	
	T28 -35		09.80-09.97	44/52-55/57-59/ 67/69/72		0986	486 596	27	
	T28 -35D								



Master II

	1.9 dCi 80	05.00-09.03	60		0 204 123 651	23,8
	ABO	10.03-10.06	60		0 204 123 651	23,8
	ABS	10.03-10.06	60		0 204 123 634	23,8
	1.9 dTi 80	01.00-09.03	58		0 204 123 651	23,8
	2.2 dCi 90	01.00-09.03	66		0 204 123 651	23,8
	ABO	10.03-10.06	66		0 204 123 651	23,8
	ABS	10.03-10.06	66		0 204 123 634	23,8
	2.5 D	10.97-09.03	60		0 204 123 651	23,8
	2.5 dCi 100	ABS 10.03-10.06	73		0 204 123 634	23,8
		11.06-04.10	74		0 204 123 763	23,81
	2.5 dCi 100, dCi 110	ABO 10.03-04.10	73/74/81		0 204 123 651	23,8
	2.5 dCi 110, dCi 120	ABS 10.03-01.10	81/84		0 204 123 634	23,8
	2.5 dCi 120	05.00-09.03	84		0 204 123 651	23,8
	ABO	10.03-01.10	84		0 204 123 651	23,8
	2.5 dCi 120, dCi 120 FAP, dCi 150 FAP	ABO 11.06-04.10	88/107		0 204 123 651	23,8
	ABS	11.06-04.10	88/107		0 204 123 763	23,81
	2.8 D	ABO 05.01-10.04	86		0 204 123 651	23,8
	ABS	05.01-10.04	86		0 204 123 634	23,8
	2.8 dTi 110, dTi 120	10.97-09.03	81/84		0 204 123 651	23,8
	3.0 dCi 140	ABO 10.03-10.06	100		0 204 123 651	23,8
	ABS	10.03-10.06	100		0 204 123 634	23,8
	1.9 dCi 80	05.00-09.03	60		0 204 125 819	0 204 120 023
	ABO	10.03-10.06	60		0 204 125 819	0 204 120 023
	ABS	10.03-10.06	60		0 204 125 811	0 204 120 023
	1.9 dTi 80	01.00-09.03	58		0 204 125 819	0 204 120 023
	2.2 dCi 90	01.00-09.03	66		0 204 125 819	0 204 120 023
	ABO	10.03-10.06	66		0 204 125 819	0 204 120 023
	ABS	10.03-10.06	66		0 204 125 811	0 204 120 023
	2.5 D	10.97-09.03	60		0 204 125 819	0 204 120 023
	2.5 dCi 100, dCi 110	ABO 10.03-04.10	73/74/81		0 204 125 819	0 204 120 023
	2.5 dCi 100, dCi 110, dCi 120, dCi 120 FAP, dCi 150 FAP	ABS 10.03-04.10	73/74/81/84/88/107		0 204 125 811	0 204 120 023
	2.5 dCi 120	05.00-09.03	84		0 204 125 819	0 204 120 023
	ABO	10.03-01.10	84		0 204 125 819	0 204 120 023
	2.5 dCi 120, dCi 120 FAP, dCi 150 FAP	ABO 11.06-04.10	88/107		0 204 125 819	0 204 120 023
	2.8 D	ABO 05.01-10.04	86		0 204 125 819	0 204 120 023
	ABS	05.01-10.04	86		0 204 125 811	0 204 120 023
	2.8 dTi 110, dTi 120	10.97-09.03	81/84		0 204 125 819	0 204 120 023
	3.0 dCi 140	ABO 10.03-10.06	100		0 204 125 819	0 204 120 023
	ABS	10.03-10.06	100		0 204 125 811	0 204 120 023
	1.9 dCi 80	05.00-09.03	60		0 986 486 596	27
		10.03-10.06	60	Get.-Nr. PA6 002,003,004→, SEG PA6 005,052,053→, PA6 054,055→	0 986 486 596	27
				Get.-Nr. PK5 016,017,018→, GS PK5 019,020,021→, PK5 022,023,071→, PK6 019,020,029→, PK6 030,069,070→, PK6 079,080→	0 986 486 596	27
	1.9 dTi 80	01.00-09.03	58		0 986 486 596	27
	2.2 dCi 90	01.00-09.03	66		0 986 486 596	27
		10.03-10.06	66	Get.-Nr. PA6 002,003,004→, SEG PA6 005,052,053→, PA6 054,055→	0 986 486 596	27



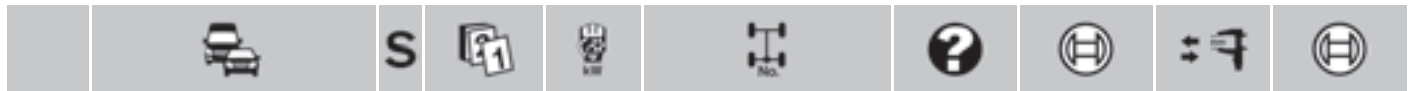

◀ RENAULT Master II									
2.2 dCi 90	10.03-10.06	66	Get.-Nr. PK5 016,017,018→, GS PK5 019,020,021→, PK5 022,023,071→, PK6 019,020,029→, PK6 030,069,070→, PK6 079,080→		0986 486 596	27			
2.5 D	10.97-09.03	60			0986 486 596	27			
2.5 dCi 100	10.03-10.06	73/81	Get.-Nr. PA6 002,003,004→, SEG PA6 005,052,053→, PA6 054,055→		0986 486 596	27			
2.5 dCi 110			Get.-Nr. PK5 016,017,018→, GS PK5 019,020,021→, PK5 022,023,071→, PK6 019,020,029→, PK6 030,069,070→, PK6 079,080→		0986 486 596	27			
2.5 dCi 120	05.00-09.03	84			0986 486 596	27			
	10.03-01.10	84	Get.-Nr. PA6 002,003,004→, SEG PA6 005,052,053→, PA6 054,055→		0986 486 596	27			
			Get.-Nr. PK5 016,017,018→, GS PK5 019,020,021→, PK5 022,023,071→, PK6 019,020,029→, PK6 030,069,070→, PK6 079,080→		0986 486 596	27			
2.8 dTi 110, dTi 120	10.97-09.03	81/84			0986 486 596	27			
3.0 dCi 140	10.03-10.06	100	Get.-Nr. PA6 002,003,004→, SEG PA6 005,052,053→, PA6 054,055→		0986 486 596	27			
			Get.-Nr. PK5 016,017,018→, GS PK5 019,020,021→, PK5 022,023,071→, PK6 019,020,029→, PK6 030,069,070→, PK6 079,080→		0986 486 596	27			
1.9 dCi 80	05.00-09.03	60		FEV,N40	0 204 031 308 ^A				
	05.00-10.06	60		R34,X38 375 ,R38	0 204 031 309 ^A 0 204 031 310 ^A				
1.9 dTi 80	01.00-09.03	58		R34,X38 375 ,R38	0 204 031 309 ^A 0 204 031 310 ^A				
				358,FEV,N40	0 204 031 308 ^A				
	02.01-09.03	58			0 204 031 310 ^A				
2.2 dCi 90	01.00-10.06	66		R34,X38 375 ,R38	0 204 031 309 ^A 0 204 031 310 ^A				
	05.00-09.03	66		FEV,N40	0 204 031 308 ^A				
	05.00-10.06	66		358,FEV,N40	0 204 031 308 ^A				
	10.97-10.06	60/73		R34,X38	0 204 031 309 ^A				
2.5 D				375 ,R38	0 204 031 310 ^A				
2.5 dCi 100	11.06-04.10	74		TW	0 204 031 308 ^A				
					0 204 031 310 ^A				
2.5 dCi 110	10.03-10.06	81		R34,X38 375 ,R38	0 204 031 309 ^A 0 204 031 310 ^A				
2.5 dCi 120	05.00-09.03	84		FEV,N40	0 204 031 308 ^A				
	05.00-01.10	84		R34,X38 375 ,R38	0 204 031 309 ^A 0 204 031 310 ^A				
				358,FEV,N40	0 204 031 308 ^A				
2.5 dCi 120, dCi 120 FAP, dCi 150 FAP	11.06-04.10	88/107		TW	0 204 031 308 ^A				
					0 204 031 310 ^A				
2.8 D, dTi 110, dTi 120	10.97-10.04	81/84/86		R34,X38 375 ,R38	0 204 031 309 ^A 0 204 031 310 ^A				





3.0 dCi 140	10.03-10.06	100	R34,X38	0 204 031 309 ^A	
			3T5,R38	0 204 031 310 ^A	

Megane



	1.9 TD	ABS 08.98-12.99	77	RLE	0 204 123 176	20,6
	2.0i	05.98-05.01	85	JBH	F 026 003 180	20,6
ABO 05.98-05.01		85	JBH	0 986 480 851	23,8	
ABS 05.98-05.01		85		BSY 0 204 123 178	20,6	
				ATE 0 986 480 830	20,6	
	2.0i 16V	ABS 07.01-07.11	103	JBH	0 986 480 977	23,8
					0 986 481 034	22,2

	2.0i	ABO 05.98-05.01	85			0 204 120 023
		ABS 05.98-05.01	85			0 204 120 023
					BSY 0 204 125 533	
	2.0i 16V	07.01-07.11	103	TW		0 204 120 023

	2.0i	05.98-05.01	85		0 204 031 314 ^A	
--	------	-------------	----	--	----------------------------	--

	1.9 D	06.99-11.01	68		0 265 216 681 ^B	
		12.01-11.09	68		0 265 216 956 ^F	
	2.0i	05.98-05.01	85		0 265 216 679 ^B	
		2.0i 16V	07.01-11.01	103		0 265 216 681 ^B
		12.01-07.11	103		0 265 216 956 ^F	

Megane [BA10]



	1.6 i	09.97-09.07	54	JBH ATE	F 026 003 243	20,6
		ABO 09.97-09.07	54	JBH BSY	F 026 003 180	20,6
		ABS 09.97-09.07	54		BSY 0 204 123 178	20,6

	1.6 i	ABS 09.97-09.07	54		BSY 0 204 125 166	0 204 120 023
					0 204 125 533	

	1.6 i	09.97-09.07	54		0 204 031 313 ^A	
--	-------	-------------	----	--	----------------------------	--

	1.6 i	09.97-11.01	54		0 265 216 681 ^B	
		12.01-09.07	54		0 265 216 956 ^F	

Megane I Cabrio [X64]



	1.4i 16V	10.00-09.03	70	JBH	0 986 480 977	23,8
		ABO 03.99-09.03	70	JBH	0 986 480 851	23,8
		ABS 10.00-09.03	70	JBH,LLE,FKØ	0 986 480 977	23,8
	1.6i			RLE	0 204 123 176	20,6
		ABO 09.96-09.03	66	JBH,LLE ATE	F 026 003 243	20,6
				BSY	F 026 003 180	20,6
				JBH,RLE	F 026 003 180	20,6
		ABS 09.96-09.03	66	LLE BSY	0 204 123 678	20,6
				JBH,LLE ATE	0 986 480 830	20,6
	1.6i 16V	01.01-09.03	79	RLE	0 204 123 176	20,6
		ABO 05.00-09.03	79	JBH	0 986 480 977	23,8
				JBH	0 986 480 851	23,8





	◀ RENAULT Megane I Cabrio [X64]									
1.6 i 16V	ABS	03.99-09.03	79		JBH,LLE	0986	480 977		23,8	
					RLE	0204	123 176		20,6	
		05.00-09.03	79		JBH,LLE,TKO	0986	480 977		23,8	
2.0 i	ABO	09.96-09.03	83		JBH,LLE	ATE	F 026	003 243	20,6	
						BSY	F 026	003 180	20,6	
					JBH,RLE		F 026	003 180	20,6	
	ABS	09.96-09.03	83		LLE	BSY	0204	123 678	20,6	
				JBH,LLE	ATE	0986	480 830	20,6		
				RLE		0204	123 176	20,6		
2.0 i 16V		09.96-09.03	108		JBH	F 026	003 940		23,8	
		01.01-09.03	102		JBH,LLE		0986	480 977	23,8	
					RLE		0204	123 176	20,6	
2.0 i 16V IDE		03.99-09.03	103		JBH,LLE		0986	480 977	23,8	
					RLE		0204	123 176	20,6	
		01.01-09.03	103		JBH		0986	480 977	23,8	
	ABO	10.00-09.03	103		JBH		0986	480 851	23,8	
	ABS	10.00-09.03	103		JBH,LLE		0986	480 977	23,8	
					RLE		0204	123 176	20,6	

	1.4 i 16V		10.00-09.03	70						0204	120 023	
								LLE			0204	120 023
								RLE			0204	120 023
		ABO	03.99-09.03	70						0204	120 023	
1.6 i	ABS	09.96-10.97	66		LLE	BSY	0204	125 166		0204	120 023	
		11.97-09.03	66		LLE	BSY	0204	125 533				
1.6 i 16V		01.01-09.03	79							0204	120 023	
	ABO	03.99-09.03	79		LLE					0204	120 023	
		05.00-09.03	79							0204	120 023	
	ABS	03.99-09.03	79		RLE					0204	120 023	
		05.00-09.03	79		LLE					0204	120 023	
2.0 i		09.96-09.03	83		LLE	BSY	0204	125 533		0204	120 023	
2.0 i 16V		09.96-09.03	108		LLE							
		01.01-09.03	102		LLE					0204	120 023	
					RLE					0204	120 023	
2.0 i 16V IDE		03.99-09.03	103		LLE					0204	120 023	
					RLE					0204	120 023	
	ABO	10.00-09.03	103							0204	120 023	
	ABS	10.00-09.03	103		LLE					0204	120 023	
					RLE					0204	120 023	

	1.4 i 16V	03.99-09.03	70					0204	031 314^A	
		10.00-09.03	70					0204	031 313^A	
1.6 i		09.96-09.03	66					0204	031 311^A	
1.6 i 16V		03.99-09.03	79					0204	031 314^A	
		05.00-09.03	79					0204	031 313^A	
2.0 i		09.96-09.03	83					0204	031 311^A	
2.0 i 16V		09.96-09.98	108		RLE			0204	031 329^A	
		09.96-09.03	108		LLE			0204	031 311^A	
		10.98-09.03	108		RLE			0204	031 313^A	
2.0 i 16V IDE		03.99-09.03	103		LLE			0204	031 314^A	
					RLE			0204	031 313^A	

	1.4 i 16V	03.99-09.03	70					0265	216 679^B	
		10.00-09.03	70		TKO			0265	216 679^B	
					TKO			0265	225 106^F	
1.6 i		09.96-09.03	66			BO		0265	216 556^B	
1.6 i 16V		03.99-09.03	79			BO		0265	216 681^B	
		05.00-11.01	79		TKO			0265	216 681^B	
		05.00-09.03	79		TKO			0265	225 106^F	
		01.01-11.01	79					0265	216 681^B	
		12.01-09.03	79					0265	216 954^B	
					TKO			0265	216 954^B	



2.0i	09.96-09.03	83		BO	0 265 216 556 ^B
2.0i 16V	01.01-11.01	102			0 265 216 681 ^B
	12.01-09.03	102			0 265 216 954 ^B
2.0i 16V IDE	03.99-09.03	103		BO	0 265 216 681 ^B
	10.00-11.01	103			0 265 216 681 ^B
	12.01-09.03	103			0 265 216 954 ^B

Megane I Classic [X64]











	1.4 i	02.99-09.03	51	Mot.-Nr. →DA03199	BSY	0 204 123 678	20,6	
		05.00-09.03	70		JBH,RLE	0 986 480 830	20,6	
		11.00-09.03	70		JBH,LLE,TKO	0 986 481 034	22,2	
		07.01-09.03	70		JBH	0 986 481 034	22,2	
		ABO	09.96-09.03	55		JBH	ATE F 026 003 243	20,6
						BSY	F 026 003 180	20,6
		02.99-09.03	51	Mot.-Nr. →DA03199	JBH	ATE F 026 003 243	20,6	
					BSY	F 026 003 180	20,6	
					Mot.-Nr. DA03200→	JBH	0 986 480 851	23,8
		05.00-09.03	70		JBH,LLE	0 986 480 851	23,8	
ABS	09.96-09.03	55		BSY	0 204 123 678	20,6		
	02.99-09.03	51	Mot.-Nr. →DA03199	JBH	ATE 0 986 480 830	20,6		
			Mot.-Nr. DA03200→	JBH	0 986 481 034	22,2		
	05.00-09.03	70		JBH,LLE	0 986 481 034	22,2		
1.4i 16V	03.99-09.03	70		JBH,RLE	ATE 0 986 480 830	20,6		
	ABO	03.99-09.03	70		JBH	0 986 480 851	23,8	
ABS	03.99-09.03	70		JBH,LLE	0 986 481 034	22,2		
1.6 i	09.96-09.03	66		JBH	ATE F 026 003 243	20,6		
				BSY	F 026 003 180	20,6		
	05.00-09.03	79		JBH,LLE	0 986 480 977	23,8		
				RLE	0 204 123 176	20,6		
	11.00-09.03	79		JBH,LLE,TKO	0 986 480 977	23,8		
	ABO	09.96-03.99	66		JBH,LLE	ATE F 026 003 243	20,6	
					JBH	BSY F 026 003 180	20,6	
	09.96-09.03	55		JBH	ATE F 026 003 243	20,6		
				BSY	F 026 003 180	20,6		
	04.99-09.03	66		JBH,LLE	0 986 480 851	23,8		
	10.99-09.03	79		JBH	0 986 480 851	23,8		
	ABS	09.96-03.99	66		LLE	BSY 0 204 123 678	20,6	
					JBH,LLE	ATE 0 986 480 830	20,6	
	09.96-09.03	55			BSY	0 204 123 678	20,6	
		66			RLE	BSY 0 204 123 176	20,6	
	04.99-09.03	66		JBH,LLE	0 986 481 034	22,2		
10.99-09.03	79		JBH	0 986 481 034	22,2			
1.6i 16V	ABO	08.98-09.03	79		2TO,JBH	0 986 480 851	23,8	
	ABS	08.98-09.03	79		RLE	0 204 123 176	20,6	
				2TO,JBH,LLE	0 986 481 034	22,2		
				4TO,JBH,LLE	0 986 480 977	23,8		
1.8 i	05.00-09.03	85		JBH,LLE	0 986 480 977	23,8		
				JBH,TKO	0 986 480 977	23,8		
				RLE	0 204 123 176	20,6		
		88		JBH,LLE	0 986 480 977	23,8		
				RLE	0 204 123 176	20,6		
	11.00-09.03	85		JBH,LLE,TKO	0 986 480 977	23,8		
		88		JBH,LLE,TKO	0 986 480 977	23,8		
	1.9 D	ABO	09.96-09.03	47		JBH	ATE F 026 003 243	20,6
					BSY	F 026 003 180	20,6	
		47-48			JBH	ATE F 026 003 243	20,6	
					BSY	F 026 003 180	20,6	
06.98-09.03		47-48		JBH	0 986 480 851	23,8		
ABS		09.96-09.03	47		LLE	BSY 0 204 123 678	20,6	
				JBH,LLE	ATE 0 986 480 830	20,6		
				RLE	0 204 123 176	20,6		





Model	Engine	Year Range	Power	Accessories	Part No.	Price	Part No.	Price		
RENAULT Megane I Classic [X64]										
1.9 D	ABS	09.96-09.03	47-48		BSY	0 204 123 678		20,6		
					JBH	ATE	0 986 480 830		20,6	
			06.98-09.03	47-48		JBH,LLE	0 986 481 034		22,2	
	1.9 D Turbo	ABO	09.96-09.03	66-69		JBH,LLE	ATE	F 026 003 243	20,6	
						JBH	ATE	F 026 003 243	20,6	
							BSY	F 026 003 180	20,6	
		ABS	09.96-09.03	66-69		BSY	0 204 123 678		20,6	
					LLE	BSY	0 204 123 678		20,6	
					JBH,LLE	ATE	0 986 480 830		20,6	
					JBH	ATE	0 986 480 830		20,6	
				RLE	BSY	0 204 123 176		20,6		
1.9 DCI	05.00-09.03	75		JBH,LLE	0 986 480 977		23,8			
				JBH,RLE	0 986 480 830		20,6			
				RLE	0 204 123 176		20,6			
	ABO	04.99-09.03	72-75		JBH	0 986 480 851		23,8		
		05.00-09.03	75		JBH,LLE	0 986 480 851		23,8		
	ABS	04.99-09.03	72-75		JBH,LLE	0 986 480 977		23,8		
					RLE,TKO	0 204 123 176		20,6		
					RLE	0 204 123 176		20,6		
			05.00-09.03	75		JBH,LLE	0 986 481 034		22,2	
			11.00-09.03	59		JBH,LLE,TKO	0 986 480 977		23,8	
1.9 DTI	ABO	08.97-02.99	72		JBH,LLE,TW	0 986 480 851		23,8		
		08.97-09.03	72		JBH,LLE	ATE	F 026 003 243	20,6		
					JBH	BSY	F 026 003 180	20,6		
		04.99-09.03	72		JBH,LLE,TW	0 986 480 851		23,8		
	ABS	08.97-09.03	72		LLE	BSY	0 204 123 678		20,6	
					JBH,LLE	ATE	0 986 480 830		20,6	
					RLE	BSY	0 204 123 176		20,6	
			04.99-09.03	72		JBH,LLE	0 986 480 977		23,8	
						JBH,LLE,TW	0 986 481 034		22,2	
						RLE	0 204 123 176		20,6	
2.0 i	09.96-09.03	84		JBH	ATE	F 026 003 243		20,6		
					BO	F 026 003 180		20,6		
		11.00-09.03	101,5		JBH	0 986 481 034		22,2		
		03.01-09.03	101,5		JBH,TKO	0 986 480 977		23,8		
			102		JBH,LLE	0 986 481 034		22,2		
	ABO	09.96-04.97	83-84		JBH,LLE	ATE	F 026 003 243		20,6	
					JBH	BSY	F 026 003 180		20,6	
			09.96-03.99	84		JBH	BSY	F 026 003 180		20,6
			09.96-09.03	84		JBH,LLE	ATE	F 026 003 243		20,6
			04.99-09.03	84		JBH,LLE,TW	0 986 480 851		23,8	
		ABS	09.96-04.97	83-84		LLE	BSY	0 204 123 678		20,6
						JBH,LLE	ATE	0 986 480 830		20,6
						RLE	BSY	0 204 123 176		20,6
			09.96-03.99	84		LLE	BSY	0 204 123 678		20,6
						JBH,LLE	ATE	0 986 480 830		20,6
	09.96-09.03		84		RLE	BSY	0 204 123 176		20,6	
	08.97-09.03		84		RLE	0 204 123 176		20,6		
	04.99-09.03	84		JBH,LLE,TW	0 986 481 034		22,2			
1.4 i	02.99-09.03	51	Mot.-Nr. →DA03199		BSY	0 204 125 533		0 204 120 023		
					LLE,TKO			0 204 120 023		
		11.00-09.03	70		LLE,TKO			0 204 120 023		
					RLE			0 204 120 023		
		07.01-09.03	70					0 204 120 023		
	ABO	09.96-09.03	55		2TO	BSY	0 204 125 533		0 204 120 023	
					4TO	BSY	0 204 125 166		0 204 120 023	
		02.99-09.03	51	Mot.-Nr. DA03200→				0 204 120 023		
		05.00-09.03	70					0 204 120 023		
	ABS	02.99-09.03	51	Mot.-Nr. DA03200→					0 204 120 023	
								0 204 120 023		
	05.00-09.03	70					0 204 120 023			

									
1.4i 16V		03.99-09.03	70			RLE	ATE		0 204 120 023
	ABO	03.99-09.03	70						0 204 120 023
	ABS	03.99-09.03	70			LLE			0 204 120 023
1.6i		09.96-09.03	55				BO	0 204 125 166	
			66			RLE	BSY		0 204 120 023
						2TO	BSY	0 204 125 533	0 204 120 023
		05.00-09.03	79			LLE			0 204 120 023
						RLE			0 204 120 023
		01.01-09.03	79						0 204 120 023
	ABO	09.96-09.03	66			2TO	BSY	0 204 125 533	0 204 120 023
						4TO	BSY	0 204 125 166	0 204 120 023
		08.99-09.03	66			LLE			0 204 120 023
		10.99-09.03	79						0 204 120 023
	ABS	09.96-10.97	66			LLE	BSY	0 204 125 166	0 204 120 023
		11.97-03.99	66			LLE	BSY	0 204 125 533	
		08.99-09.03	66			LLE			0 204 120 023
		10.99-09.03	79						0 204 120 023
1.6i 16V	ABO	08.98-09.03	79						0 204 120 023
	ABS	08.98-09.03	79			LLE,VSD			0 204 120 023
						LLE,VSD			0 204 120 023
					RLE			0 204 120 023	
1.8i		05.00-09.03	85/88						0 204 120 023
						LLE			0 204 120 023
						RLE			0 204 120 023
1.9D		12.97-09.03	47			LLE	BSY	0 204 125 533	0 204 120 023
			47-48				BSY	0 204 125 533	0 204 120 023
	ABO	09.96-04.97	47			4TO	BSY		0 204 120 023
		09.96-11.97	47			2TO,LLE			0 204 120 023
						4TO,LLE			0 204 120 023
			47-48			2TO			0 204 120 023
						4TO			0 204 120 023
		06.98-09.03	47-48						0 204 120 023
	ABS	09.96-11.97	47			LLE	BSY		0 204 120 023
			47-48				BSY		0 204 120 023
	06.98-09.03	47-48			LLE			0 204 120 023	
1.9D Turbo		09.96-09.03	66-69				BSY	0 204 125 533	0 204 120 023
						LLE	BSY	0 204 125 533	0 204 120 023
						RLE			0 204 120 023
1.9DCI		05.00-09.03	75			LLE			0 204 120 023
						RLE			0 204 120 023
	ABO	04.99-09.03	72-75						0 204 120 023
		05.00-09.03	75						0 204 120 023
	ABS	04.99-09.03	72-75			LLE,TW			0 204 120 023
						RLE			0 204 120 023
		05.00-09.03	75						0 204 120 023
									0 204 120 023
1.9DTI		08.97-02.99	72			RLE	BSY		0 204 120 023
		08.97-09.03	72			LLE	BSY	0 204 125 533	0 204 120 023
						RLE			0 204 120 023
		04.99-09.03	72			LLE			0 204 120 023
		11.00-09.03	59			LLE			0 204 120 023
						RLE			0 204 120 023
	ABO	08.97-02.99	72			TW			0 204 120 023
		04.99-09.03	72			TW			0 204 120 023
		08.99-09.03	72			LLE,TW			0 204 120 023
	ABS	08.99-09.03	72			LLE			0 204 120 023
2.0i		09.96-04.97	83-84			LLE	BSY	0 204 125 533	0 204 120 023
		09.96-03.99	84			LLE	BSY	0 204 125 533	0 204 120 023
		09.96-09.03	84				BSY	0 204 125 533	0 204 120 023
		04.99-09.03	84			LLE			0 204 120 023
		11.00-09.03	101,5			TKO			0 204 120 023
						TKO			0 204 120 023
		03.01-09.03	101,5 102						0 204 120 023 0 204 120 023





◀ RENAULT Megane I Classic [X64]

2.0 i	ABO	09.96-04.97	83-84			0 204 120 023
			84			0 204 120 023

1.4 i	09.96-09.03	55		2TO	0 204 031 329 ^A	
				4TO	0 204 031 311 ^A	
	02.99-09.03	51			0 204 031 314 ^A	
	05.00-09.03	70			0 204 031 313 ^A	
1.4 i 16V	03.99-09.03	70		2TO	0 204 031 313 ^A	
				4TO	0 204 031 314 ^A	
1.6 i	09.96-09.98	66			0 204 031 329 ^A	
	09.96-09.03	55			0 204 031 311 ^A	
		66		2TO	0 204 031 329 ^A	
				4TO	0 204 031 311 ^A	
	10.98-09.03	66		RLE	0 204 031 313 ^A	
	10.99-09.03	79			0 204 031 313 ^A	
1.6 i 16V	08.98-09.03	79		2TO	0 204 031 313 ^A	
				4TO	0 204 031 314 ^A	
1.8 i	05.00-09.03	85/88			0 204 031 313 ^A	
1.9 D	09.96-09.03	47		2TO	0 204 031 329 ^A	
				4TO	0 204 031 311 ^A	
		47-48		2TO	0 204 031 329 ^A	
				4TO	0 204 031 311 ^A	
	06.98-09.03	47-48		2TO	0 204 031 313 ^A	
			4TO	0 204 031 314 ^A		
1.9 D Turbo	09.96-09.03	66-69			0 204 031 314 ^A	
1.9 DCI	04.99-09.03	72-75			0 204 031 314 ^A	
	05.00-09.03	75			0 204 031 313 ^A	
1.9 DTI	08.97-09.03	72			0 204 031 314 ^A	
	04.99-09.03	72			0 204 031 313 ^A	
2.0 i	09.96-04.97	83-84			0 204 031 314 ^A	
				2TO	0 204 031 329 ^A	
	09.96-09.03	84			0 204 031 314 ^A	
				2TO	0 204 031 329 ^A	

1.4 i	09.96-09.03	55		BO	0 265 216 556 ^B	
	02.99-02.99	51		BO	0 265 216 556 ^B	
	03.99-09.03	51			0 265 216 679 ^B	
	11.00-09.03	70		TKO	0 265 216 681 ^B	
			TKO	0 265 225 106 ^F		
1.4 i, i 16V	03.99-09.03	70			0 265 216 679 ^B	
1.6 i	09.96-02.99	66		BO	0 265 216 556 ^B	
	09.96-09.03	55		BO	0 265 216 556 ^B	
	03.99-09.03	66			0 265 216 679 ^B	
	10.99-09.03	79			0 265 216 679 ^B	
	05.00-09.03	79		BO	0 265 216 681 ^B	
	11.00-09.03	79		TKO	0 265 216 681 ^B	
				TKO	0 265 225 106 ^F	
	01.01-09.03	79			0 265 225 106 ^F	
1.6 i 16V	08.98-09.03	79		FEN	0 265 216 681 ^B	
				FEV	0 265 216 679 ^B	
1.8 i	05.00-09.03	85			0 265 225 106 ^F	
				BO	0 265 216 681 ^B	
		88		BO	0 265 216 681 ^B	
	11.00-09.03	85		TKO	0 265 216 681 ^B	
				TKO	0 265 225 106 ^F	
	88		TKO	0 265 216 681 ^B		
			TKO	0 265 225 106 ^F		
1.9 D	09.96-09.03	47		BO	0 265 216 681 ^B	
		47-48		BO	0 265 216 556 ^B	
	06.98-09.03	47-48			0 265 216 679 ^B	
1.9 D Turbo	09.96-09.03	66-69		BO	0 265 216 556 ^B	

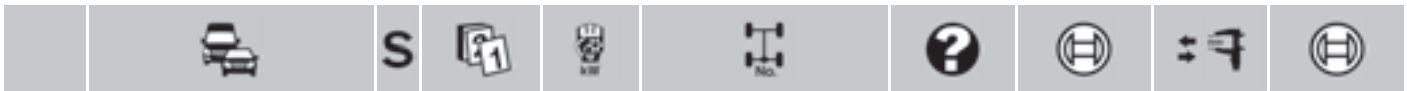

1.9 DCI	04.99-09.03	72-75		BO	0 265 216 681 ^B	
	05.00-09.03	75			0 265 216 679 ^B	
				BO	0 265 216 681 ^B	
1.9 DTI	08.97-02.99	72		BO	0 265 216 556 ^B	
	08.97-09.03	72		BO	0 265 216 681 ^B	
	08.99-09.03	72			0 265 216 679 ^B	
	11.00-09.03	59			0 265 216 679 ^B	
					0 265 225 106 ^F	
2.0i	09.96-09.03	83-84		TW BO	0 265 216 679 ^B	
	03.01-09.03	101,5			0 265 225 106 ^F	

	1.9 DTI	11.00-09.03	59		0 265 005 263	
--	---------	-------------	----	--	---------------	--

Megane I Coupé [X64]



	1.4i 16V	03.01-10.02	70		JBH	0 986 480 977	23,8
		ABO 03.99-10.02	70		JBH	0 986 480 851	23,8
		ABS 03.99-10.02	70		JBH,LLE	0 986 481 034	22,2
					JBH,RLE	0 986 480 830	20,6
		05.00-10.02	70		JBH,LLE,TKO	0 986 480 977	23,8
			RLE	0 204 123 176	20,6		
1.6i	ABO 01.96-10.02	66		JBH,LLE BSY	F 026 003 180	20,6	
				JBH,RLE	F 026 003 180	20,6	
	09.96-10.02	66		JBH,LLE ATE	F 026 003 243	20,6	
	ABS 01.96-10.02	66		JBH,LLE ATE	0 986 480 830	20,6	
				RLE	0 204 123 176	20,6	
09.96-10.02	66		LLE BSY	0 204 123 678	20,6		
1.6i 16V	03.01-10.02	79		JBH	0 986 480 977	23,8	
			ABO 05.00-10.02	79		JBH	0 986 480 851
	ABS 03.99-10.02	79		JBH,LLE	0 986 480 977	23,8	
				RLE	0 204 123 176	20,6	
	05.00-10.02	79		JBH,LLE,TKO	0 986 480 977	23,8	
1.9 DCI	ABO 05.00-10.02	75		JBH	0 986 480 851	23,8	
			ABS 03.99-10.02	72-75		JBH,LLE	0 986 480 977
	05.00-10.02	75		JBH,LLE	0 986 480 977	23,8	
				RLE	0 204 123 176	20,6	
1.9 DTI	ABO 06.97-10.02	72		JBH ATE	F 026 003 243	20,6	
				BSY	F 026 003 180	20,6	
	ABS 06.97-03.99	72		BSY	0 204 123 678	20,6	
				JBH ATE	0 986 480 830	20,6	
	04.99-10.02	72		JBH	0 986 480 977	23,8	
2.0i	ABO 01.96-03.97	83		JBH,LLE BSY	F 026 003 180	20,6	
				JBH,RLE	F 026 003 180	20,6	
	01.96-10.02	83		JBH,LLE ATE	F 026 003 243	20,6	
			04.97-10.02	83		JBH	F 026 003 180
		84		JBH,LLE ATE	F 026 003 243	20,6	
				JBH	F 026 003 180	20,6	
	ABS 01.96-10.02	83		LLE BSY	0 204 123 678	20,6	
				JBH,LLE ATE	0 986 480 830	20,6	
				RLE	0 204 123 176	20,6	
	04.97-10.02	84		LLE BSY	0 204 123 678	20,6	
				JBH,LLE ATE	0 986 480 830	20,6	
				RLE	0 204 123 176	20,6	
2.0i 16V	09.96-03.99	108		JBH	F 026 003 940	23,8	
			04.99-10.02	108		JBH,LLE	0 986 480 977
				RLE	0 204 123 176	20,6	
	09.01-10.02	102		RLE	0 204 123 176	20,6	
	11.01-10.02	102		JBH,LLE	0 986 480 977	23,8	
	ABS 09.01-10.02	102		JBH	0 986 480 977	23,8	
			JBH,LLE,TKO	0 986 480 977	23,8		





RENAULT Megane I Coupé [X64]

	2.0 i 16V IDE	03.99-10.02	103	JBH,LLE	0 986 480 977	23,8	
				RLE	0 204 123 176	20,6	
		03.01-10.02	103	JBH	0 986 480 977	23,8	
		ABO 05.00-10.02	103	JBH	0 986 480 851	23,8	
		ABS 05.00-10.02	103	JBH,LLE	0 986 480 977	23,8	
				RLE	0 204 123 176	20,6	
	1.4 i 16V	05.00-10.02	70	LLE		0 204 120 023	
				RLE		0 204 120 023	
		03.01-10.02	70			0 204 120 023	
		ABO 03.99-10.02	70			0 204 120 023	
		05.00-10.02	70	LLE		0 204 120 023	
		ABS 03.99-10.02	70	LLE		0 204 120 023	
			RLE	ATE		0 204 120 023	
				BSY		0 204 120 023	
	1.6 i	ABO 01.96-10.02	66	LLE	BSY	0 204 125 533	
		ABS 01.96-10.97	66	LLE	BSY	0 204 125 166	0 204 120 023
		11.97-10.02	66	LLE	BSY	0 204 125 533	0 204 120 023
	1.6 i 16V	03.01-10.02	79				0 204 120 023
ABO 03.99-10.02		79	LLE			0 204 120 023	
05.00-10.02		79				0 204 120 023	
ABS 03.99-10.02		79	RLE			0 204 120 023	
	05.00-10.02	79	LLE			0 204 120 023	
1.9 DCI	03.99-10.02	72-75				0 204 120 023	
	05.00-10.02	75				0 204 120 023	
	ABO 05.00-10.02	75				0 204 120 023	
	ABS 05.00-10.02	75	LLE			0 204 120 023	
			RLE			0 204 120 023	
1.9 DTI	06.97-02.99	72		BSY	0 204 125 533	0 204 120 023	
	03.99-10.02	72				0 204 120 023	
2.0 i	09.96-10.02	83/84	LLE	BSY	0 204 125 533	0 204 120 023	
2.0 i 16V	01.96-02.99	108	LLE		0 204 125 170		
	03.99-10.02	108	LLE			0 204 120 023	
			RLE			0 204 120 023	
	09.01-10.02	102	LLE			0 204 120 023	
			RLE			0 204 120 023	
	11.01-10.02	102				0 204 120 023	
2.0 i 16V IDE	03.99-10.02	103	LLE			0 204 120 023	
			RLE			0 204 120 023	
	03.01-10.02	103				0 204 120 023	
	ABO 05.00-10.02	103				0 204 120 023	
	ABS 05.00-10.02	103	LLE			0 204 120 023	
			RLE			0 204 120 023	
	1.4 i 16V	03.99-10.02	70			0 204 031 313 ^A	
	1.6 i	01.96-08.96	66			0 204 031 312 ^A	
		09.96-10.02	66			0 204 031 313 ^A	
	1.6 i 16V	03.99-10.02	79			0 204 031 313 ^A	
	1.9 DCI, DTI	06.97-10.02	72-75			0 204 031 313 ^A	
	2.0 i	01.96-10.02	83/84			0 204 031 313 ^A	
	2.0 i 16V	01.96-09.98	108	RLE		0 204 031 329 ^A	
		01.96-10.02	108	LLE		0 204 031 311 ^A	
		10.98-10.02	108	RLE		0 204 031 313 ^A	
	2.0 i 16V IDE	03.99-10.02	103	LLE		0 204 031 311 ^A	
				RLE		0 204 031 313 ^A	
		05.00-10.02	103	LLE		0 204 031 314 ^A	
	1.4 i 16V	03.99-10.02	70			0 265 216 679 ^B	
		05.00-11.01	70	TKO		0 265 216 679 ^B	
		05.00-10.02	70	TKO		0 265 225 106 ^F	
		12.01-10.02	70			0 265 216 956 ^F	
				TKO		0 265 216 956 ^F	

		S							
1.6i		01.96-10.02	66				BO	0 265 216 556 ^B	
1.6i 16V		03.99-10.02	79				BO	0 265 216 681 ^B	
		05.00-11.01	79			TKO		0 265 216 681 ^B	
		05.00-10.02	79			TKO		0 265 225 106 ^F	
		03.01-11.01	79					0 265 216 681 ^B	
		12.01-10.02	79					0 265 216 954 ^B	
						TKO		0 265 216 954 ^B	
1.9 DCI		03.99-11.01	72-75			TKO		0 265 216 681 ^B	
		03.99-10.02	72-75			TKO		0 265 225 106 ^F	
		05.00-11.01	75					0 265 216 681 ^B	
						TKO		0 265 216 681 ^B	
		05.00-10.02	75			TKO		0 265 225 106 ^F	
		12.01-10.02	72-75			TKO		0 265 216 954 ^B	
			75					0 265 216 954 ^B	
						TKO		0 265 216 954 ^B	
1.9 DTI		03.99-10.02	72				BO	0 265 216 681 ^B	
2.0i		01.96-10.02	83/84				BO	0 265 216 556 ^B	
2.0i 16V		03.99-10.02	108				BO	0 265 216 681 ^B	
		09.01-11.01	102			TKO		0 265 216 681 ^B	
		09.01-10.02	102			TKO		0 265 225 106 ^F	
		11.01-11.01	102					0 265 216 681 ^B	
		12.01-10.02	102					0 265 216 954 ^B	
						TKO		0 265 216 954 ^B	
2.0i 16V IDE		03.99-10.02	103				BO	0 265 216 681 ^B	
		05.00-11.01	103					0 265 216 681 ^B	
		12.01-10.02	103					0 265 216 954 ^B	

Megane I Grandtour [X64]

1.4i		ABS	03.99-09.03	51			JBH	0 986 481 034	22,2
1.4i, i 16V		ABO	03.99-09.03	51/70			JBH	0 986 480 851	23,8
1.4i 16V			01.00-09.03	70			JBH,TKO	0 986 481 034	22,2
			05.00-09.03	70			JBH	0 986 481 034	22,2
		ABS	03.99-09.03	70			JBH	0 986 481 034	22,2
1.6i		ABO	07.98-03.99	66			JBH	F 026 003 180	20,6
			04.99-09.03	66			JBH	0 986 480 851	23,8
		ABS	07.98-03.99	66				0 204 123 678	20,6
			04.99-09.03	66			JBH	0 986 481 034	22,2
1.6i 16V			03.99-09.03	79			JBH	0 986 480 977	23,8
		ABO	03.99-09.03	79			JBH	0 986 481 035	23,81
		ABS	03.99-09.03	79			JBH	0 986 480 977	23,8
1.8i 16V			10.00-09.03	85/88			JBH	0 986 480 977	23,8
1.9 D			01.01-09.03	59			JBH,TKO	0 986 480 977	23,8
		ABO	03.99-09.03	47			JBH	0 986 480 851	23,8
		ABS	03.99-09.03	47			JBH	0 986 481 034	22,2
1.9 DCI			05.01-09.03	75			JBH	0 986 480 977	23,8
		ABO	05.00-09.03	75			JBH	0 986 480 851	23,8
		ABS	05.00-09.03	75			JBH	0 986 481 034	22,2
1.9 DCI		ABO	07.98-09.03	72-75			JBH	0 986 481 035	23,81
1.9 DTI		ABS	07.98-09.03	72-75			JBH	0 986 480 977	23,8

1.4i		ABO	03.99-09.03	51					0 204 120 023
		ABS	03.99-09.03	51					0 204 120 023
1.4i 16V			01.00-09.03	70			TKO		0 204 120 023
							TKO		0 204 120 023
			05.00-09.03	70					0 204 120 023
		ABO	03.99-09.03	70					0 204 120 023
		ABS	03.99-09.03	70					0 204 120 023
			05.00-09.03	70			TW		0 204 120 023
1.6i		ABO	04.99-09.03	66					0 204 120 023
		ABS	04.99-09.03	66					0 204 120 023



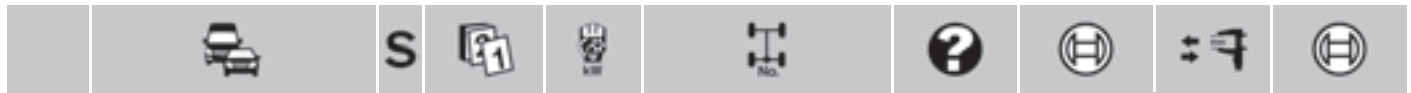

RENAULT Megane I Grandtour [X64]









1.6 i 16V		03.99-09.03	79				0 204 120 023
	ABO	03.99-09.03	79				0 204 120 023
	ABS	03.99-09.03	79				0 204 120 023
1.8 i 16V		10.00-09.03	85/88				0 204 120 023
	1.9 D	03.99-09.03	47		BSY		0 204 120 023
1.9 D		01.01-09.03	59				0 204 120 023
	ABO	03.99-09.03	47				0 204 120 023
	ABS	03.99-09.03	47				0 204 120 023
1.9 DCI		05.01-09.03	75				0 204 120 023
	ABO	03.99-09.03	72-75				0 204 120 023
		05.00-09.03	75				0 204 120 023
	ABS	03.99-09.03	72-75				0 204 120 023
1.9 DTI		05.00-09.03	75		TW		0 204 120 023
	ABO	07.98-09.03	72				0 204 120 023
	ABS	07.98-09.03	72				0 204 120 023

1.4 i, i 16V		03.99-09.03	51/70			0 204 031 295^A
	1.6 i, i 16V	07.98-09.03	66/79			0 204 031 295^A
	1.9 D, DCI, DTI	07.98-09.03	47/72-75			0 204 031 295^A

1.4 i		03.99-09.03	51			0 265 216 679^B
	1.4 i 16V	03.99-09.03	70			0 265 216 679^B
		01.00-09.03	70		TKO	0 265 216 679^B
1.6 i		07.98-09.03	66			0 265 216 679^B
	1.6 i 16V	03.99-09.03	79		BO	0 265 216 681^B
1.8 i 16V		01.01-09.03	79		TKO	0 265 216 681^B
					TKO	0 265 225 106^F
		10.00-09.03	85/88		BO	0 265 216 681^B
1.9 D		03.01-09.03	85/88		TKO	0 265 216 681^B
					TKO	0 265 225 106^F
		04.99-09.03	47			0 265 216 679^B
1.9 DCI		01.01-09.03	59		TKO	0 265 216 681^B
					TKO	0 265 225 106^F
		05.00-09.03	75			0 265 216 679^B
1.9 DTI		05.01-09.03	75		BO	0 265 216 681^B
		07.98-09.03	72		BO	0 265 216 681^B

Megane I [X64]

1.4 i	ABO	01.96-02.99	51-52		JBH	ATE	F 026 003 243	20,6	
			55		JBH,LLE	ATE	F 026 003 243	20,6	
					JBH	BSY	F 026 003 180	20,6	
		03.99-03.99	51-55		JBH	ATE	F 026 003 243	20,6	
				JBH	BSY	F 026 003 180	20,6		
				JBH	ATE	F 026 003 243	20,6		
		04.99-10.02	51-55		JBH		0 986 480 851	23,8	
	ABS			01.96-02.99	51-52			0 204 123 678	20,6
					55		LLE	BSY	0 204 123 678
		03.99-03.99	51-55			RLE	BSY	0 204 123 176	20,6
					BSY	0 204 123 678	20,6		
					JBH	ATE	0 986 480 830	20,6	
	1.4 i 16V		04.99-10.02	51-55		JBH		0 986 481 034	22,2
					JBH,RLE	ATE	0 986 480 830	20,6	
			06.98-10.02	70		JBH,LLE,TKO		0 986 481 034	22,2
		JBH,RLE				0 986 480 830	20,6		
		ABO	06.98-10.02	70		JBH		0 986 480 851	23,8
		ABS	06.98-10.02	70		JBH,LLE		0 986 481 034	22,2
		05.00-10.02	70		JBH	ATE	0 986 480 830	20,6	
						BO	0 986 481 034	22,2	

		S							
1.6i		01.01-10.02	66			JBH	0 986 480 851		23,8
	ABO	01.96-02.99	55			JBH ATE	F 026 003 243		20,6
						BSY	F 026 003 180		20,6
			66			JBH,LLE ATE	F 026 003 243		20,6
						JBH ATE	F 026 003 243		20,6
						BSY	F 026 003 180		20,6
	ABS	01.96-02.99	55				0 204 123 678		20,6
			66				0 204 123 678		20,6
						LLE BSY	0 204 123 678		20,6
						RLE BSY	0 204 123 176		20,6
1.6i 16V		05.00-10.02	79			RLE	0 204 123 176		20,6
		01.01-10.02	79			JBH,LLE,TKO	0 986 480 977		23,8
	ABO	06.98-10.02	79			2TO,JBH	0 986 480 851		23,8
		10.99-10.02	79			JBH	0 986 480 851		23,8
	ABS	06.98-10.02	79			RLE	0 204 123 176		20,6
						2TO,JBH,LLE	0 986 481 034		22,2
						4TO,JBH,LLE	0 986 480 977		23,8
		10.99-10.02	79			JBH	0 986 481 034		22,2
		01.01-10.02	79			JBH	0 986 480 977		23,8
	1.8i 16V		03.99-10.02	85/88			JBH,LLE	0 986 480 977	
						JBH,LLE,TKO	0 986 480 977		23,8
						RLE	0 204 123 176		20,6
1.9D		06.98-10.02	47-48			JBH,RLE ATE	0 986 480 830		20,6
	ABO	01.96-02.99	47			FAH,JBH	F 026 003 103		19
			47-48			JBH BSY	F 026 003 180		20,6
						FAH,JBH	F 026 003 103		19
						JBH BSY	F 026 003 180		20,6
		06.98-10.02	47-48			JBH	0 986 480 851		23,8
	ABS	01.96-02.99	47			LLE BSY	0 204 123 678		20,6
			47-48			RLE BSY	0 204 123 176		20,6
						LLE BSY	0 204 123 678		20,6
						RLE BSY	0 204 123 176		20,6
	06.98-10.02	47-48			JBH,LLE	0 986 481 034		22,2	
1.9D Turbo	ABO	01.96-02.99	66-70			JBH,LLE ATE	F 026 003 243		20,6
						JBH ATE	F 026 003 243		20,6
						BSY	F 026 003 180		20,6
	ABS	01.96-02.99	66-70				0 204 123 678		20,6
					LLE BSY	0 204 123 678		20,6	
					RLE BSY	0 204 123 176		20,6	
1.9DCI		03.99-10.02	75			JBH,LLE,TKO	0 986 481 034		22,2
						JBH,RLE	0 986 480 830		20,6
		01.01-10.02	75			JBH,LLE	0 986 480 977		23,8
						RLE	0 204 123 176		20,6
	ABO	03.99-10.02	72-75			JBH	0 986 480 851		23,8
		05.00-10.02	75			JBH	0 986 480 851		23,8
		01.01-10.02	75			JBH,LLE	0 986 480 851		23,8
	ABS	03.99-10.02	72-75			JBH,LLE	0 986 480 977		23,8
						JBH	0 986 480 977		23,8
						RLE	0 204 123 176		20,6
	05.00-10.02	75			JBH,LLE	0 986 480 977		23,8	
					RLE	0 204 123 176		20,6	
	01.01-10.02	75			JBH,LLE	0 986 481 034		22,2	
1.9DTI		01.01-10.02	59			JBH,TKO	0 986 481 034		22,2
						JBH,TKO	0 986 480 977		23,8
						RLE	0 204 123 176		20,6
	ABO	06.97-02.99	69			JBH BSY	F 026 003 180		20,6
		06.97-10.02	72			JBH,LLE ATE	F 026 003 243		20,6
						BSY	F 026 003 180		20,6
					JBH ATE	F 026 003 243		20,6	
					BSY	F 026 003 180		20,6	
					JBH,RLE	F 026 003 180		20,6	













RENAULT Megane I [X64]

1.9 DTI	ABS	06.97-02.99	69	LLE	BSY	0 204 123 678	20,6	
				RLE	BSY	0 204 123 176	20,6	
				72	RLE	BSY	0 204 123 176	20,6
		06.97-03.99	72			BSY	0 204 123 678	20,6
					LLE	BSY	0 204 123 678	20,6
					JBH	ATE	0 986 480 830	20,6
		06.97-10.02	72		RLE		0 204 123 176	20,6
		04.99-10.02	72		JBH,LLE		0 986 480 977	23,8
					JBH		0 986 480 977	23,8
	2.0 i	01.97-02.99	83	JBH	ATE	F 026 003 243	20,6	
				BSY	F 026 003 180	20,6		
JBH				ATE	F 026 003 243	20,6		
			84		BSY	F 026 003 180	20,6	
ABO		01.96-03.97	83	JBH,LLE	ATE	F 026 003 243	20,6	
				JBH	BSY	F 026 003 180	20,6	
		09.96-10.02	84	JBH,LLE	ATE	F 026 003 243	20,6	
				JBH	BSY	F 026 003 180	20,6	
		01.97-10.02	84	JBH,RLE	BSY	F 026 003 180	20,6	
ABS		01.96-10.02	83/84	LLE	BSY	0 204 123 678	20,6	
			RLE	BSY	0 204 123 176	20,6		
2.0 i 16V		01.96-10.02	108-110	JBH		F 026 003 940	23,8	
		05.00-10.02	103	JBH		0 986 481 034	22,2	
	ABO	05.00-10.02	101,5	JBH		0 986 480 851	23,8	
	ABS	05.00-10.02	101,5	JBH		0 986 481 034	22,2	
1.4 i		01.96-02.99	55	RLE	BSY		0 204 120 023	
		03.99-03.99	51-55		BSY	0 204 125 533	0 204 120 023	
	ABO	01.96-02.99	51-52		BSY	0 204 125 533	0 204 120 023	
			55	LLE	BSY	0 204 125 533	0 204 120 023	
		03.99-10.02	51-55				0 204 120 023	
	ABS	01.96-02.99	51-52		BSY	0 204 125 166	0 204 120 023	
			55	LLE	BSY	0 204 125 166	0 204 120 023	
		03.99-10.02	51-55				0 204 120 023	
1.4 i 16V		01.01-10.02	70	LLE			0 204 120 023	
				RLE			0 204 120 023	
	ABO	06.98-10.02	70				0 204 120 023	
		05.00-10.02	70	LLE			0 204 120 023	
				RLE			0 204 120 023	
	ABS	06.98-10.02	70	LLE			0 204 120 023	
				RLE	ATE		0 204 120 023	
					BSY		0 204 120 023	
	05.00-10.02	70	RLE			0 204 120 023		
1.6 i		01.96-02.99	66		BSY	0 204 125 533	0 204 120 023	
				RLE	BSY		0 204 120 023	
	ABO	01.96-02.99	55		BSY	0 204 125 533	0 204 120 023	
			66	LLE	BSY	0 204 125 533	0 204 120 023	
		01.01-10.02	66				0 204 120 023	
	ABS	01.96-02.99	55		BSY	0 204 125 166	0 204 120 023	
			66	LLE	BSY	0 204 125 166	0 204 120 023	
		01.01-10.02	66				0 204 120 023	
1.6 i 16V		05.00-10.02	79	LLE			0 204 120 023	
				RLE			0 204 120 023	
	ABO	06.98-10.02	79	2TO			0 204 120 023	
		10.99-10.02	79				0 204 120 023	
		01.01-10.02	79	LLE			0 204 120 023	
				RLE			0 204 120 023	
	ABS	06.98-10.02	79	RLE			0 204 120 023	
				2TO,LLE			0 204 120 023	
				4TO,LLE			0 204 120 023	
		10.99-10.02	79				0 204 120 023	
	01.01-10.02	79	LLE	ATE		0 204 120 023		
				BO		0 204 120 023		



		S							
1.8i 16V		03.99-10.02	85/88						0 204 120 023
						LLE			0 204 120 023
						RLE			0 204 120 023
1.9D		01.96-02.99	47			FAH			0 204 120 023
						RLE			0 204 120 023
			47-48			FAH			0 204 120 023
						RLE	BSY		0 204 120 023
		01.97-02.99	47			RLE	BSY		0 204 120 023
		01.98-02.99	47			LLE	BSY	0 204 125 533	0 204 120 023
		06.98-10.02	47-48			RLE	ATE		0 204 120 023
	ABO	01.96-03.97	47-48			LLE	BSY	0 204 125 533	0 204 120 023
		01.96-12.97	47			LLE	BSY		0 204 120 023
		01.96-02.99	47-48			LIS,LLE			0 204 120 023
		01.97-02.99	47			LIS,LLE			0 204 120 023
		06.98-10.02	47-48				ATE		0 204 120 023
	ABS	01.96-03.97	47-48			LIS,LLE			0 204 120 023
		01.96-02.99	47			LIS,LLE			0 204 120 023
						LLE	BSY		0 204 120 023
			47-48			LLE	BSY		0 204 120 023
		06.98-10.02	47-48			LLE	ATE		0 204 120 023
1.9D Turbo		01.96-02.99	66-70				BSY	0 204 125 533	0 204 120 023
						LLE	BSY	0 204 125 533	0 204 120 023
						RLE	BSY		0 204 120 023
1.9DCI		01.01-10.02	75			LLE			0 204 120 023
						RLE			0 204 120 023
	ABO	03.99-10.02	72-75				ATE		0 204 120 023
			75			LLE			0 204 120 023
						RLE			0 204 120 023
		05.00-10.02	75				ATE		0 204 120 023
	ABS	03.99-10.02	72-75				ATE		0 204 120 023
						LLE	ATE		0 204 120 023
						RLE			0 204 120 023
			75			LLE			0 204 120 023
						RLE			0 204 120 023
		05.00-10.02	75			LLE	ATE		0 204 120 023
1.9DTI		06.97-02.99	69			LLE	BSY	0 204 125 533	0 204 120 023
						RLE	BSY		0 204 120 023
			72			RLE	BSY		0 204 120 023
		06.97-03.99	72			LLE	BSY	0 204 125 533	0 204 120 023
		06.97-10.02	72			RLE			0 204 120 023
		03.99-03.99	72				BSY	0 204 125 533	0 204 120 023
		03.99-10.02	72			LLE			0 204 120 023
		01.01-10.02	59						0 204 120 023
						LLE			0 204 120 023
						RLE			0 204 120 023
2.0i		01.96-10.02	83/84			LLE	BSY	0 204 125 533	0 204 120 023
						RLE	BSY		0 204 120 023
		01.97-02.99	83/84				BSY	0 204 125 533	0 204 120 023
2.0i 16V		01.96-10.02	108-110					0 204 125 170	0 204 120 023
		05.00-10.02	103						0 204 120 023
	ABO	05.00-10.02	101,5						0 204 120 023
	ABS	05.00-10.02	101,5						0 204 120 023
 1.4i		01.96-02.99	55			2TO		0 204 031 329 ^A	
						4TO		0 204 031 313 ^A	
		01.96-10.02	51-55					0 204 031 313 ^A	
1.4i 16V		06.98-10.02	70					0 204 031 313 ^A	
1.6i		01.96-02.99	66					0 204 031 329 ^A	
						2TO		0 204 031 329 ^A	
						4TO		0 204 031 313 ^A	
		07.96-02.99	55					0 204 031 313 ^A	
		01.01-10.02	66					0 204 031 313 ^A	



		S									
RENAULT Megane I [X64]											
1.6 i 16V		06.98-10.02	79				2TO		0 204 031 314 ^A		
							4TO		0 204 031 313 ^A		
		10.99-10.02	79						0 204 031 313 ^A		
1.8 i 16V		03.99-10.02	85/88						0 204 031 313 ^A		
1.9 D		01.96-03.97	47-48						0 204 031 313 ^A		
									01.96-02.99	47	
									4TO	0 204 031 313 ^A	
		03.97-02.99	47-48						LWG	0 204 031 313 ^A	
		06.98-10.02	47-48							0 204 031 313 ^A	
1.9 D Turbo		01.96-02.99	66-70							0 204 031 313 ^A	
1.9 DCI		03.99-10.02	72-75							0 204 031 314 ^A	
											75
		05.00-10.02	75							0 204 031 314 ^A	
1.9 DTI		06.97-02.99	69/72							0 204 031 314 ^A	
		06.97-10.02	72							0 204 031 313 ^A	
2.0 i		01.96-10.02	83/84							2TO	0 204 031 329 ^A
										4TO	0 204 031 313 ^A
		01.97-02.99	83/84							0 204 031 329 ^A	
2.0 i 16V		01.96-10.02	108-110							0 204 031 329 ^A	
1.4 i											
		01.96-02.99	51-52/55						BO	0 265 216 556 ^B	
		03.99-10.02	51-55							0 265 216 679 ^B	
1.4 i 16V		06.98-10.02	70							0 265 216 679 ^B	
										01.01-10.02	70
1.6 i		01.96-02.99	55/66						BO	0 265 216 556 ^B	
										01.01-10.02	66
1.6 i 16V		06.98-10.02	79							FEN	0 265 216 681 ^B
		10.99-10.02	79							0 265 216 679 ^B	
		05.00-10.02	79						BO	0 265 216 681 ^B	
		01.01-10.02	79							0 265 225 106 ^F	
1.8 i 16V		03.99-10.02	85/88							0 265 225 106 ^F	
									BO	0 265 216 681 ^B	
1.9 D		01.96-02.99	47-48						BO	0 265 216 556 ^B	
										06.98-10.02	47-48
1.9 D Turbo, DTI		01.96-02.99	66-70						BO	0 265 216 556 ^B	
1.9 DCI		03.99-10.02	72-75						BO	0 265 216 681 ^B	
											75
		05.00-10.02	75						BO	0 265 216 681 ^B	
1.9 DTI		06.97-02.99	72						BO	0 265 216 556 ^B	
		03.99-10.02	72						BO	0 265 216 681 ^B	
		01.01-10.02	59						BO	0 265 216 681 ^B	
									BO	0 265 216 681 ^B	
2.0 i		01.96-10.02	83/84							0 265 216 556 ^B	
2.0 i 16V		05.00-10.02	101,5/103						BO	0 265 216 681 ^B	
1.4 i 16V											
		01.01-10.02	70						TKO	0 265 005 263	
1.6 i 16V											
		01.01-10.02	79						TKO	0 265 005 263	
1.8 i 16V											
		03.99-10.02	85/88						TKO	0 265 005 263	
1.9 DTI											
		01.01-10.02	59						TKO	0 265 005 263	
2.0 i 16V											
		05.00-10.02	101,5/103							0 265 005 263	
Megane II Cabrio [EM]											
1.5 DCI		12.05-03.10	76/78							BO	0 204 701 702
										JBH	TRW
1.6 16V		10.03-03.10	83							BO	0 204 701 702
										JBH	TRW

		S									
1.9 DCI		10.03-03.10	88/96					BO	0 204 701 702		
								JBH TRW	0 986 481 002	23,81	
2.0 DCI, T, 16V		10.03-03.10	99/110/ 120					BO	0 204 701 702		
								JBH TRW	0 986 481 002	23,81	
1.5 DCI		12.05-01.06	76/78						0 265 234 311 ^T		
		12.05-03.10	76/78						0 265 232 068 ^B		
		02.06-03.10	76/78						0 265 234 469 ^T		
1.6 16V		10.03-09.04	83						0 265 231 301 ^F		
		10.03-08.05	83						0 265 231 735 ^B		
		10.03-01.06	83						0 265 234 311 ^T		
		09.05-03.10	83						0 265 232 068 ^B		
		02.06-03.10	83						0 265 234 469 ^T		
1.9 DCI		10.03-09.04	88/96						0 265 231 301 ^F		
		10.03-08.05	88/96						0 265 231 735 ^B		
		10.03-01.06	88/96						0 265 234 311 ^T		
		09.05-03.10	88/96						0 265 232 068 ^B		
		02.06-03.10	88/96						0 265 234 469 ^T		
2.0 DCI		10.03-09.04	99/110/120						0 265 231 301 ^F		
2.0 T		10.03-08.05	99/110/120						0 265 231 735 ^B		
2.0 16V		10.03-01.06	99/110/120						0 265 234 311 ^T		
		09.05-03.10	99/110/120						0 265 232 068 ^B		
		02.06-03.10	99/110/120						0 265 234 469 ^T		
1.5 DCI		12.05-03.10	76/78						0 265 005 263		
1.6 16V		10.03-03.10	83						0 265 005 263		
1.9 DCI		10.03-03.10	88/96						0 265 005 263		
2.0 DCI, T, 16V		10.03-03.10	99/110/120						0 265 005 263		
Megane II Grandtour											
1.6 16V Hi-Flex		12.06-08.12	81-85					BO	0 204 701 702		
								JBH TRW	0 986 481 002	23,81	
Megane II Grandtour [KM.]											
1.4 16V		10.03-05.09	72					BO	0 204 701 702		
								JBH TRW	0 986 481 002	23,81	
1.5 DCI		10.03-05.09	60/63/76/ 78					BO	0 204 701 702		
								JBH TRW	0 986 481 002	23,81	
1.6		10.03-05.09	83					BO	0 204 701 702		
1.6 16V								JBH TRW	0 986 481 002	23,81	
1.6 Flex-Fuel		02.08-05.09	77					BO	0 204 701 702		
								JBH, TW TRW	0 986 481 002	23,81	
1.9 DCI		10.03-05.09	68/88/96					BO	0 204 701 702		
								JBH TRW	0 986 481 002	23,81	
2.0 DCI		10.03-05.09	99/110					BO	0 204 701 702		
2.0 16V								JBH TRW	0 986 481 002	23,81	
1.4 16V		10.03-08.05	72						0 265 231 301 ^F		
									0 265 231 735 ^B		
		10.03-12.05	72	Komp.Nr. EAS					0 265 234 129 ^T		
		10.03-05.09	72	Komp.Nr. EA1,EA2,EA3,EA4					0 265 234 311 ^T		
		09.05-05.09	72						0 265 232 068 ^B		
		01.06-05.09	72	Komp.Nr. EAS	ES2				0 265 234 615 ^T		
					ES5				0 265 234 614 ^T		
1.5 DCI		10.03-08.05	60/63						0 265 231 301 ^F		
			76						0 265 231 735 ^B		
		10.03-12.05	60/63/76	Komp.Nr. EAS					0 265 234 129 ^T		





RENAULT Megane II Grandtour [KM.]









1.5 DCI	10.03-05.09	60/63/76	Komp.Nr. EA1,EA2,EA3,EA4		0 265 234 311 ^T
	10.04-08.05	78			0 265 231 301 ^F 0 265 231 735 ^B
	10.04-12.05	78	Komp.Nr. EAS		0 265 234 129 ^T
	10.04-05.09	78	Komp.Nr. EA1,EA2,EA3,EA4		0 265 234 311 ^T
	09.05-05.09	60/63/76/78			0 265 232 068 ^B
	01.06-05.09	60/63/76/	Komp.Nr. EAS	ES2	0 265 234 615 ^T
		78		ES5	0 265 234 614 ^T
1.6	10.03-08.05	83			0 265 231 301 ^F 0 265 231 735 ^B
1.6 16V	10.03-12.05	83	Komp.Nr. EAS		0 265 234 129 ^T
	10.03-05.09	83	Komp.Nr. EA1,EA2,EA3,EA4		0 265 234 311 ^T
	09.05-05.09	83			0 265 232 068 ^B
	01.06-05.09	83	Komp.Nr. EAS	ES2	0 265 234 615 ^T
				ES5	0 265 234 614 ^T
1.6 Flex-Fuel	02.08-05.09	77			0 265 232 068 ^B 0 265 234 469 ^T
1.9 DCI	10.03-08.05	68/88/96			0 265 231 301 ^F 0 265 231 735 ^B
	10.03-12.05	68/88/96	Komp.Nr. EAS		0 265 234 129 ^T
	10.03-05.09	68/88/96	Komp.Nr. EA1,EA2,EA3,EA4		0 265 234 311 ^T
	09.05-05.09	68/88/96			0 265 232 068 ^B
	01.06-05.09	68/88/96	Komp.Nr. EAS	ES2	0 265 234 615 ^T
ES5				0 265 234 614 ^T	
2.0 DCI	10.03-08.05	99/110			0 265 231 301 ^F 0 265 231 735 ^B
2.0 16V	10.03-12.05	99/110	Komp.Nr. EAS		0 265 234 129 ^T
	10.03-05.09	99/110	Komp.Nr. EA1,EA2,EA3,EA4		0 265 234 311 ^T
	09.05-05.09	99/110			0 265 232 068 ^B
	01.06-05.09	99/110	Komp.Nr. EAS	ES2	0 265 234 615 ^T
				ES5	0 265 234 614 ^T

1.4 16V	10.03-05.09	72			0 265 005 263
1.5 DCI	10.03-05.09	60/63/76/78			0 265 005 263
1.6, Flex-Fuel, 16V	10.03-05.09	77/83			0 265 005 263
1.9 DCI	10.03-05.09	68/88/96			0 265 005 263
2.0 DCI, 16V	10.03-05.09	99/110			0 265 005 263

Megane II Hatchback [BM./CM./GM./SM.]

1.4 16V	11.02-10.08	72		BO	0 204 701 702	
				JBH TRW	0 986 481 002	23,81
1.5 DCI	11.02-10.08	60/63/76/78		BO	0 204 701 702	
				JBH TRW	0 986 481 002	23,81
1.6	11.02-10.08	83		BO	0 204 701 702	
1.6 16V				JBH TRW	0 986 481 002	23,81
1.6 16V Flex-Fuel	01.07-10.08	77		BO	0 204 701 702	
				JBH,TW TRW	0 986 481 002	23,81
1.9 dCi	11.02-10.08	68/88/96		BO	0 204 701 702	
1.9 DCI				JBH TRW	0 986 481 002	23,81
2.0, dCi, DCI, T, 16V	11.02-10.08	99/110/120		BO	0 204 701 702	
				JBH TRW	0 986 481 002	23,81
2.0 DCI Sport	04.07-10.08	127		BO	0 204 701 702	
				JBH,TW TRW	0 986 481 002	23,81
2.0 16V Sport	03.03-10.08	165		BO	0 204 701 702	
				JBH TRW	0 986 481 002	23,81

1.4 16V	11.02-09.04	72			0 265 231 301 ^F
	11.02-08.05	72			0 265 231 735 ^B
	11.02-12.05	72	Komp.Nr. EAS		0 265 234 129 ^T
	11.02-10.08	72	Komp.Nr. EA1,EA2,EA3,EA4		0 265 234 311 ^T

		S							
1.4 16V	09.05-10.08	72					0 265 232 068 ^B		
	01.06-10.08	72	Komp.Nr. EAS		ES2		0 265 234 615 ^T		
					ES5		0 265 234 614 ^T		
1.5 DCI	11.02-09.04	60					0 265 231 301 ^F		
	11.02-08.05	60					0 265 231 735 ^B		
		63/76/78					0 265 231 735 ^B		
	11.02-12.05	60	Komp.Nr. EAS				0 265 234 129 ^T		
		63/76/78	Komp.Nr. EAS				0 265 234 129 ^T		
	11.02-10.08	60	Komp.Nr. EA1,EA2,EA3,EA4				0 265 234 311 ^T		
		63/76/78	Komp.Nr. EA1,EA2,EA3,EA4				0 265 234 311 ^T		
	09.05-10.08	60					0 265 232 068 ^B		
		63/76/78					0 265 232 068 ^B		
	01.06-10.08	60	Komp.Nr. EAS		ES2		0 265 234 615 ^T		
				ES5		0 265 234 614 ^T			
	63/76/78	Komp.Nr. EAS		ES2		0 265 234 615 ^T			
				ES5		0 265 234 614 ^T			
1.6	11.02-08.05	83					0 265 231 735 ^B		
1.6 16V	11.02-12.05	83	Komp.Nr. EAS				0 265 234 129 ^T		
	11.02-10.08	83	Komp.Nr. EA1,EA2,EA3,EA4				0 265 234 311 ^T		
	09.05-10.08	83					0 265 232 068 ^B		
01.06-10.08	83	Komp.Nr. EAS		ES2			0 265 234 615 ^T		
				ES5			0 265 234 614 ^T		
1.6 16V	11.02-09.04	83					0 265 231 301 ^F		
1.6 16V Flex-Fuel	01.07-10.08	77					0 265 232 068 ^B		
							0 265 234 469 ^T		
1.9 DCI	11.02-09.04	68/88					0 265 231 301 ^F		
	11.02-08.05	68/88					0 265 231 735 ^B		
	11.02-12.05	68/88	Komp.Nr. EAS				0 265 234 129 ^T		
	11.02-10.08	68/88	Komp.Nr. EA1,EA2,EA3,EA4				0 265 234 311 ^T		
	09.05-10.08	68/88					0 265 232 068 ^B		
	01.06-10.08	68/88	Komp.Nr. EAS		ES2		0 265 234 615 ^T		
				ES5		0 265 234 614 ^T			
1.9 dCi	09.04-08.05	96					0 265 231 735 ^B		
1.9 DCI	09.04-12.05	96	Komp.Nr. EAS				0 265 234 129 ^T		
	09.04-10.08	96	Komp.Nr. EA1,EA2,EA3,EA4				0 265 234 311 ^T		
	09.05-10.08	96					0 265 232 068 ^B		
	01.06-10.08	96	Komp.Nr. EAS		ES2		0 265 234 615 ^T		
					ES5		0 265 234 614 ^T		
2.0	11.02-09.04	99					0 265 231 301 ^F		
2.0 16V	11.02-08.05	99					0 265 231 735 ^B		
	11.02-12.05	99	Komp.Nr. EAS				0 265 234 129 ^T		
	11.02-10.08	99	Komp.Nr. EA1,EA2,EA3,EA4				0 265 234 311 ^T		
	09.05-10.08	99					0 265 232 068 ^B		
	01.06-10.08	99	Komp.Nr. EAS		ES2		0 265 234 615 ^T		
					ES5		0 265 234 614 ^T		
2.0 DCI Sport	04.07-10.08	127					0 265 232 068 ^B		
							0 265 234 469 ^T		
2.0 dCi	09.04-08.05	110					0 265 231 735 ^B		
2.0 DCI	09.04-12.05	110	Komp.Nr. EAS				0 265 234 129 ^T		
	09.04-10.08	110	Komp.Nr. EA1,EA2,EA3,EA4				0 265 234 311 ^T		
	09.05-10.08	110					0 265 232 068 ^B		
	01.06-10.08	110	Komp.Nr. EAS		ES2		0 265 234 615 ^T		
					ES5		0 265 234 614 ^T		
2.0 T	05.04-09.04	120					0 265 231 301 ^F		
	05.04-08.05	120					0 265 231 735 ^B		
	05.04-12.05	120	Komp.Nr. EAS				0 265 234 129 ^T		
	05.04-10.08	120	Komp.Nr. EA1,EA2,EA3,EA4				0 265 234 311 ^T		
	09.05-10.08	120					0 265 232 068 ^B		
	01.06-10.08	120	Komp.Nr. EAS		ES2		0 265 234 615 ^T		
				ES5		0 265 234 614 ^T			



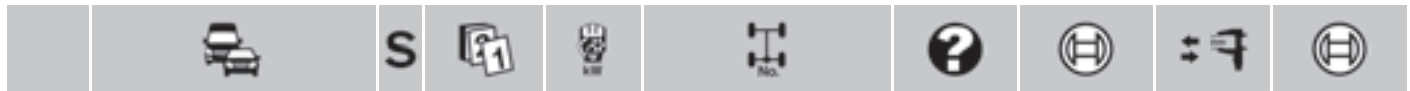

RENAULT Megane II Hatchback [BM./CM./GM./SM.]

	2.0 16V Sport	03.03-08.05	165			0 265 231 735 ^B	
		03.03-12.05	165	Komp.Nr. EAS		0 265 234 129 ^T	
		03.03-10.08	165	Komp.Nr. EA1,EA2,EA3,EA4		0 265 234 311 ^T	
		09.05-10.08	165			0 265 232 068 ^B	
		01.06-10.08	165	Komp.Nr. EAS	ES2 ES5	0 265 234 615 ^T 0 265 234 614 ^T	
	1.4 16V	11.02-10.08	72			0 265 005 263	
		1.5 DCI	11.02-10.08	60/63/76/78		0 265 005 263	
		1.6, 16V, 16V Flex-Fuel	11.02-10.08	77/83		0 265 005 263	
		1.9 dCi, DCI	11.02-10.08	68/88/96		0 265 005 263	
		2.0, dCi, DCI, DCI Sport, T, 16V, 16V Sport	11.02-10.08	99/110/120/127/165		0 265 005 263	

Megane II [LM]

	1.4	10.03-10.09	72		BO	0 204 701 702		
					JBH	TRW	0 986 481 002	23,81
		1.5 dCi	11.02-10.09	60/63/76/78		BO	0 204 701 702	
					JBH	TRW	0 986 481 002	23,81
		1.6	10.03-10.09	83		BO	0 204 701 702	
					JBH	TRW	0 986 481 002	23,81
		1.9 dCi	10.03-10.09	68/88/96		BO	0 204 701 702	
					JBH	TRW	0 986 481 002	23,81
		2.0	09.02-10.09	99/110		BO	0 204 701 702	
		2.0 dCi				JBH	TRW	0 986 481 002

	1.4	10.03-08.05	72			0 265 231 735 ^B		
		10.03-01.06	72			0 265 234 311 ^T		
		09.05-10.09	72			0 265 232 068 ^B		
		02.06-10.09	72			0 265 234 469 ^T		
		1.5 dCi	11.02-08.05	60/63/76/78			0 265 231 735 ^B	
	1.5 dCi	11.02-01.06	60/63/76/78			0 265 234 311 ^T		
				09.05-10.09	60/63/76/78		0 265 232 068 ^B	
				02.06-10.09	60/63/76/78		0 265 234 469 ^T	
				1.6	10.03-08.05	83		0 265 231 735 ^B
	1.6	10.03-01.06	83			0 265 234 311 ^T		
				09.05-10.09	83		0 265 232 068 ^B	
				02.06-10.09	83		0 265 234 469 ^T	
				1.9 dCi	10.03-08.05	68/88/96		0 265 231 735 ^B
	1.9 dCi	10.03-01.06	68/88/96			0 265 234 311 ^T		
				09.05-10.09	68/88/96		0 265 232 068 ^B	
				02.06-10.09	68/88/96		0 265 234 469 ^T	
				2.0	09.02-08.05	99/110		0 265 231 735 ^B
	2.0 dCi	09.02-01.06	99/110			0 265 234 311 ^T		
				09.05-10.09	99/110		0 265 232 068 ^B	
				02.06-10.09	99/110		0 265 234 469 ^T	

	1.4	10.03-10.09	72			0 265 005 263	
		1.5 dCi	11.02-10.09	60/63/76/78		0 265 005 263	
		1.6	10.03-10.09	83		0 265 005 263	
		1.9 dCi	10.03-10.09	68/88/96		0 265 005 263	
		2.0, dCi	09.02-10.09	99/110		0 265 005 263	

Megane III CC [EZ]

	1.6 dCi	11.12->	96			0 986 486 615	30
		1.9 dCi	10.10->	96		0 986 486 615	30

		S							
Megane III Coupé [DZ]									
	1.6 dCi	01.12→	96				0 986 486 615	30	
	1.9 dCi	01.09→	96				0 986 486 615	30	
Megane III Grandtour [KZ]									
	1.6 dCi	01.12→	96				0 986 486 615	30	
	1.9 dCi	06.09→	96				0 986 486 615	30	
Megane III Hatchback [BZ]									
	1.6	MFD 11.11→	81-85				0 204 701 709		
		OFD 11.11→	81-85				0 204 701 708		
	1.6	MFD 11.11→	81-85		LLE		0 204 125 953		
					RLE		0 204 125 954		
		OFD 11.11→	81-85		LLE		0 204 125 951		
					RLE		0 204 125 952		
	1.6 dCi	01.12→	96				0 986 486 615	30	
	1.9 dCi	11.08→	96				0 986 486 615	30	
Megane [L/BA00]									
	1.6 i 16V GNC	ABO 06.03→	69		JBH	BSY	F 026 003 180	20,6	
Modus [FP/JP]									
	1.2	OFD 09.04-01.05	55/57,5		JBH,LLE		0 986 480 886	23,8	
		02.05→	55/57,5		LLE	ATE	0 986 481 057	23,81	
	1.2 TCe	OFD 10.07→	74		LLE	ATE	0 986 481 057	23,81	
	1.4	06.04-01.05	72		HTB,JBH,LLE		0 986 480 886	23,8	
		02.05-12.06	72		HTB,LLE	ATE	0 986 481 057	23,81	
	1.5 dCi	09.04-01.05	65		HTB,JBH,LLE		0 986 480 886	23,8	
		02.05-12.06	65		HTB,LLE	ATE	0 986 481 057	23,81	
		OFD 09.04-01.05	50		JBH,LLE		0 986 480 886	23,8	
			63		JBH,LLE		0 986 480 886	23,8	
			78		JBH,LLE		0 986 480 886	23,8	
		02.05→	50		LLE	ATE	0 986 481 057	23,81	
			63		LLE	ATE	0 986 481 057	23,81	
			78		LLE	ATE	0 986 481 057	23,81	
		10.10→	55		LLE	ATE	0 986 481 057	23,81	
			65		LLE	ATE	0 986 481 057	23,81	
	1.6	OFD 09.04-01.05	83		JBH,LLE		0 986 480 886	23,8	
		02.05→	82		LLE	ATE	0 986 481 057	23,81	
			83		LLE	ATE	0 986 481 057	23,81	
	1.2	09.04-12.06	55				0 265 234 619 ^T		
		09.04-05.07	55				0 265 231 803 ^B		
		11.04-12.06	57,5				0 265 234 619 ^T		
		11.04-05.07	57,5				0 265 231 803 ^B		
		01.07-01.08	55				0 265 234 619 ^T		
			57,5				0 265 234 619 ^T		



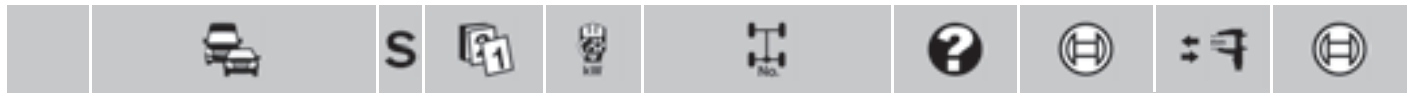

RENAULT Modus [FP/JP]













1.2	06.07→	55		0 265 232 076 ^B	
		57,5		0 265 232 076 ^B	
	02.08→	55	FKR	0 265 234 619 ^T	
		57,5	FKR	0 265 234 619 ^T	
1.2 TCe	10.07-01.08	74		0 265 234 619 ^T	
	10.07→	74		0 265 232 076 ^B	
	02.08→	74	FKR	0 265 234 619 ^T	
1.4	06.04-12.05	72		0 265 231 360 ^B	
	06.04-12.06	72		0 265 234 619 ^T	
	01.06-12.06	72		0 265 231 803 ^B	
1.5 dCi	09.04-12.05	65		0 265 231 360 ^B	
	09.04-12.06	50		0 265 234 619 ^T	
		63		0 265 234 619 ^T	
		65		0 265 234 619 ^T	
		78		0 265 234 619 ^T	
	09.04-05.07	50		0 265 231 803 ^B	
		63		0 265 231 803 ^B	
		78		0 265 231 803 ^B	
		50		0 265 234 619 ^T	
	01.06-12.06	65		0 265 231 803 ^B	
		78		0 265 234 619 ^T	
	01.07-01.08	50		0 265 234 619 ^T	
		63		0 265 234 619 ^T	
		78		0 265 234 619 ^T	
	06.07→	50		0 265 232 076 ^B	
		63		0 265 232 076 ^B	
		78		0 265 232 076 ^B	
	02.08→	50	FKR	0 265 234 619 ^T	
		63	FKR	0 265 234 619 ^T	
		78	FKR	0 265 234 619 ^T	
	10.10→	55		0 265 232 076 ^B	
			FKR	0 265 234 619 ^T	
	65		0 265 232 076 ^B		
			FKR	0 265 234 619 ^T	
1.6	09.04-12.05	65		0 265 231 360 ^B	
	09.04-12.06	65		0 265 234 619 ^T	
		83		0 265 234 619 ^T	
	09.04-05.07	83		0 265 231 803 ^B	
	02.05-12.06	82		0 265 234 619 ^T	
	02.05-05.07	82		0 265 231 803 ^B	
	01.06-12.06	65		0 265 231 803 ^B	
	01.07-01.08	82		0 265 234 619 ^T	
		83		0 265 234 619 ^T	
	06.07→	82		0 265 232 076 ^B	
		83		0 265 232 076 ^B	
	02.08→	82	FKR	0 265 234 619 ^T	
83		FKR	0 265 234 619 ^T		

	1.2, TCe	09.04→	55/57,5/74		0 265 005 263	
	1.4	06.04-12.06	72		0 265 005 263	
	1.5 dCi	09.04→	50/55/63/65/78		0 265 005 263	
	1.6	09.04→	65/82/83		0 265 005 263	

Safrane [B54]



	2.0 i	04.92-09.96	97-99		F 026 003 138	22,22		
		03.95-09.96	77	Fg.-Nr. S 31502→	F 026 003 138	22,22		
		ABO	04.92-02.95	77	Fg.-Nr. →S 31501	RLE	F 026 003 138	22,22
		ABS	04.92-02.95	77			F 026 003 138	22,22
2.0 i 16V		10.96-10.96	100		LLE	F 026 003 138	22,22	
		10.96-12.00	100		RLE	F 026 003 138	22,22	
		11.96-12.00	100		JBH,LLE	F 026 003 940	23,8	

									
2.1 D Turbo		03.95-09.96	65-66	Fg.-Nr. S 52002→				F 026 003 138	22,22
		ABS 04.92-02.95	65-66					F 026 003 138	22,22
2.2 i		04.92-09.96	101-104					F 026 003 138	22,22
		03.95-09.96	79-81	Fg.-Nr. S 7002→				F 026 003 138	22,22
		ABS 04.92-02.95	79-81					F 026 003 138	22,22
2.2 12V D Turbo		10.96-12.00	83			JBH		F 026 003 940	23,8
2.5 D Turbo		07.93-05.94	83-85	Fg.-Nr. S 8790→S 16990		AG,JBH		F 026 003 940	23,8
						GS		F 026 003 138	22,22
		06.94-09.96	83-85	Fg.-Nr. S 16991→		JBH		F 026 003 940	23,8
2.5 i 20V		10.96-12.00	121			JBH		F 026 003 940	23,8
3.0 i, i Biturbo, i 24V		04.92-12.00	123-125/140/190-197			JBH		F 026 003 940	23,8
 2.0 i		04.92-09.96	97-99					0 204 125 090	
		ABS 04.92-09.96	77					0 204 125 090	
2.0 i 16V		10.96-10.96	100			LLE		0 204 125 090	
		10.96-12.00	100			RLE		0 204 125 090	
		11.96-12.00	100			LLE			0 204 120 023
2.1 D Turbo		ABS 04.92-09.96	65-66					0 204 125 090	
2.2 i		04.92-09.96	101-104					0 204 125 090	
		ABS 04.92-09.96	79-81					0 204 125 090	
2.2 12V D Turbo		10.96-10.96	83			LLE		0 204 125 090	
		10.96-12.00	83			RLE		0 204 125 090	
		11.96-12.00	83			LLE			0 204 120 023
2.5 D Turbo		04.92-09.96	83-85					0 204 125 090	
2.5 i 20V		10.96-10.96	121			LLE		0 204 125 090	
		10.96-12.00	121			RLE		0 204 125 090	
		11.96-12.00	121			LLE			0 204 120 023
3.0 i		04.92-09.96	123-125					0 204 125 090	
		10.96-10.96	123-125			LLE		0 204 125 090	
		10.96-12.00	123-125			RLE		0 204 125 090	
		11.96-12.00	123-125			LLE			0 204 120 023
3.0 i Biturbo		02.93-09.96	190-197					0 204 125 090	
3.0 i 24V		03.99-12.00	140						0 204 120 023
 2.0 i		04.92-09.96	97-99			FGD		0 204 131 063^A	
		ABO 04.92-01.95	77					0 204 131 151^A	
2.1 D Turbo		ABO 04.92-01.95	65-66					0 204 131 151^A	
2.2 i		04.92-09.96	101-104			FGD		0 204 131 063^A	
		ABO 04.92-01.95	79-81					0 204 131 151^A	
2.2 12V D Turbo		10.96-11.96	83					0 204 131 150^A	
2.5 D Turbo		04.92-05.94	83-85			AG,FGD		0 204 131 063^A	
		07.93-09.96	83-85			AG,FGD		0 204 131 150^A	
						FGD,GS		0 204 131 062^A	
		06.94-09.96	83-85			AG,FGD		0 204 131 062^A	
						FGD,GS		0 204 131 150^A	
2.5 i 20V		10.96-11.96	121					0 204 131 150^A	
3.0 i		04.92-09.96	123-125			AA,FGD		0 204 131 284^A	
						AA,FGD		0 204 131 062^A	
						AA,FGD		0 204 131 150^A	
		08.92-09.96	123-125			FGD		0 204 131 062^A	
						FGD		0 204 131 150^A	
		08.92-11.96	123-125					0 204 131 150^A	
3.0 i Biturbo		02.93-09.96	190-197					0 204 131 284^A	
 2.0 i 16V		01.97-12.00	100					0 265 216 635^H	
2.2 12V D Turbo		01.97-12.00	83					0 265 216 635^H	
2.5 i 20V		01.97-12.00	121					0 265 216 635^H	
3.0 i		04.92-09.96	123-125			AA		0 265 201 060^H	
		01.97-12.00	123-125					0 265 216 635^H	
3.0 i Biturbo		02.93-09.96	190-197			AA		0 265 201 060^H	
3.0 i 24V		03.99-12.00	140					0 265 216 635^H	



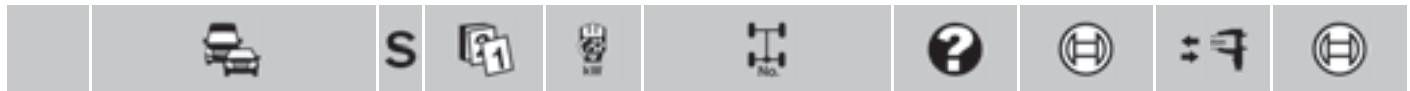

◀ RENAULT Safrane [B54]

	2.0 i, i 16V	05.92-12.00	77/97-99/100		2 267 000 738 ^H	
	2.1 D Turbo	05.92-09.96	65-66		2 267 000 738 ^H	
	2.2 i	05.92-09.96	101-104		2 267 000 738 ^H	
	2.2 i, 12V D Turbo	04.92-12.00	79-81/83/101		2 267 000 738 ^H	
	2.5 D Turbo, i 20V	05.92-12.00	83-85/121		2 267 000 738 ^H	
	3.0 i	04.92-09.96	123-125	AA	0 265 100 067 ^H	
		05.92-09.96	123-125	AA	2 267 000 738 ^H	
		08.92-12.00	123-125		2 267 000 738 ^H	
3.0 i Biturbo	02.93-09.96	190-197	AA	0 265 100 067 ^H		
3.0 i 24V	03.99-12.00	140		2 267 000 738 ^H		

	3.0 i	07.93-09.96	123-125/	AA	0 265 005 111	
	3.0 i Biturbo		190-197			

Sandero [BS]



	1.2	09.11→	55		0 265 232 719 ^B	
	1.4	12.09→	55		0 265 232 719 ^B	
	1.6, 16V	12.09→	62/64/77		0 265 232 719 ^B	

Scenic [Fase I]



	1.6 i 16V	ABO 08.99-07.10	79/81	JBH	0 986 481 035	23,81
		ABS 08.99-07.10	79/81	JBH	0 986 480 977	23,8
	2.0 i	ABO 01.99-12.01	85	JBH	0 986 481 035	23,81
		ABS 01.99-12.01	85	JBH	0 986 480 977	23,8
	2.0 i 16V	ABS 01.02-07.10	103	JBH,LLE,TKO	0 986 480 977	23,8

	1.6 i 16V	08.99-07.10	79/81			0 204 120 023
	2.0 i, i 16V	01.99-07.10	85/103			0 204 120 023

	1.6 i 16V	08.99-07.10	79/81		0 204 031 295 ^A	
	2.0 i	01.99-12.01	85		0 204 031 295 ^A	

	1.6 i 16V	08.99-05.01	79		0 265 216 681 ^B		
		06.01-07.10	81	BO	0 265 216 681 ^B		
	2.0 i	01.99-11.01	85		0 265 216 681 ^B		
		12.01-12.01	85		0 265 216 956 ^F		
	2.0 i 16V	01.02-07.10	103			0 265 216 956 ^F	

Scenic I [JA]



	1.4 i	ABO	11.96-09.98	55	JBH,LLE	F 026 003 180	20,6	
			08.98-09.98	70	JBH	F 026 003 184	22,2	
			10.98-04.03	55	JBH,LLE	0 986 481 035	23,81	
				70	JBH	0 986 481 035	23,81	
			02.00-04.03	70	JBH,LLE	0 986 481 035	23,81	
			ABS	11.96-09.98	55	LLE	0 204 123 678	20,6
					RLE	0 204 123 176	20,6	
		10.98-04.03		55	JBH,LLE,TKO	0 986 480 977	23,8	
				70	RLE,TKO	0 204 123 176	20,6	
				70	JBH,LLE,TKO	0 986 480 977	23,8	
					70	RLE,TKO	0 204 123 176	20,6
		1.6 i	ABO	01.96-09.98	66	JBH,LLE	F 026 003 180	20,6
						JBH	F 026 003 184	22,2
					11.96-09.98	55	JBH,LLE	F 026 003 180
08.98-09.98	79				JBH	F 026 003 184	22,2	

		S								
1.6i	ABO	10.98-04.03	55				JBH,LLE	0 986 481 035	23,81	
			66				JBH,LLE	0 986 481 035	23,81	
			79				JBH	0 986 481 035	23,81	
			03.99-04.03	79				JBH,LLE	0 986 481 035	23,81
	ABS	01.96-09.98	55/66					LLE	0 204 123 678	20,6
								RLE	0 204 123 176	20,6
		10.98-04.03	55/66					JBH,LLE,TKO	0 986 480 977	23,8
								RLE,TKO	0 204 123 176	20,6
								JBH,LLE,TKO	0 986 480 977	23,8
								RLE,TKO	0 204 123 176	20,6
1.8i	ABO	09.00-04.03	85/88				JBH,LLE	0 986 481 035	23,81	
	ABS	09.00-04.03	85/88				JBH,LLE,TKO	0 986 480 977	23,8	
1.9D	ABO	11.96-09.98	47-48				JBH	F 026 003 184	22,2	
		10.98-04.03	47-48				JBH	0 986 481 035	23,81	
		03.99-04.03	47				JBH,LLE	0 986 481 035	23,81	
1.9D Turbo	ABO	11.96-03.97	66-69				JBH	F 026 003 184	22,2	
		11.96-09.98	66				JBH	F 026 003 184	22,2	
		10.98-04.03	66				JBH	0 986 481 035	23,81	
1.9D, D Turbo, DTI	ABS	10.98-04.03	47-48/59/ 66/72				JBH,LLE,TKO	0 986 480 977	23,8	
							RLE,TKO	0 204 123 176	20,6	
1.9 DCI	ABO	10.98-04.03	75				JBH,LLE	0 986 481 035	23,81	
1.9 DCI RX4	ABO	10.98-04.03	75				JBH,LLE	0 986 481 035	23,81	
		02.01-04.03	75				JBH	0 986 481 035	23,81	
1.9 DCI	ABO	06.97-09.98	75				JBH,LLE	F 026 003 180	20,6	
1.9 DCI RX4	ABS	06.97-09.98	75				LLE	0 204 123 678	20,6	
								RLE	0 204 123 176	20,6
				10.98-04.03	75				JBH,LLE,TKO	0 986 480 977
							RLE,TKO	0 204 123 176	20,6	
1.9 DTI	ABO	06.97-09.98	72				JBH	F 026 003 184	22,2	
		10.98-02.99	72				JBH	0 986 481 035	23,81	
		03.99-04.03	72				JBH,LLE	0 986 481 035	23,81	
		11.00-04.03	59				JBH,LLE	0 986 481 035	23,81	
2.0i	ABO	11.96-03.97	83-84				JBH	F 026 003 184	22,2	
		11.96-09.98	84				JBH	F 026 003 184	22,2	
		10.98-04.03	84				JBH	0 986 481 035	23,81	
2.0i	ABO	03.99-04.03	101,5/102				JBH,LLE	0 986 481 035	23,81	
2.0i RX4	ABS	10.98-04.03	84/101,5/ 102				JBH,LLE,TKO	0 986 480 977	23,8	
							RLE,TKO	0 204 123 176	20,6	
	1.4i	08.98-04.03	70				RLE		0 204 120 023	
		10.98-04.03	55						0 204 120 023	
			70				LLE		0 204 120 023	
1.6i	01.96-09.98	66					AG,LLE	0 204 125 526	0 204 120 023	
							RLE	0 204 125 529	0 204 120 023	
	01.96-04.03	66					RLE		0 204 120 023	
							LLE	0 204 125 526	0 204 120 023	
	08.98-09.98	79					RLE	0 204 125 529	0 204 120 023	
									0 204 120 023	
								LLE		0 204 120 023
								LLE		0 204 120 023
								RLE		0 204 120 023
										0 204 120 023
1.8i	09.00-04.03	85					LLE		0 204 120 023	
							RLE		0 204 120 023	
								LLE		0 204 120 023
1.9D	11.96-09.98	47-48					RLE		0 204 120 023	
							LLE	0 204 125 526	0 204 120 023	
							RLE	0 204 125 529	0 204 120 023	
10.98-04.03	47-48						LLE		0 204 120 023	
							RLE		0 204 120 023	
									0 204 120 023	



RENAULT Scenic I [JA]							
1.9 D Turbo	11.96-04.03	66-69	LLE		0 204 125 526		0 204 120 023
			RLE		0 204 125 529		0 204 120 023
1.9 DCI	10.98-04.03	75	LLE				0 204 120 023
			RLE				0 204 120 023
1.9 DCI RX4	10.98-04.03	75	LLE				0 204 120 023
			RLE				0 204 120 023
1.9 DTI	06.97-09.98	72	LLE		0 204 125 526		0 204 120 023
			RLE		0 204 125 529		0 204 120 023
	10.98-04.03	72	LLE				0 204 120 023
			RLE				0 204 120 023
11.00-04.03	59	LLE				0 204 120 023	
		RLE				0 204 120 023	
2.0 i	11.96-03.97	83-84	LLE		0 204 125 526		0 204 120 023
			RLE		0 204 125 529		0 204 120 023
	11.96-09.98	84	LLE		0 204 125 526		0 204 120 023
			RLE		0 204 125 529		0 204 120 023
	10.98-04.03	84	LLE				0 204 120 023
			RLE				0 204 120 023
	03.99-04.03	101,5	LLE				0 204 120 023
			RLE				0 204 120 023
	06.00-04.03	102	LLE				0 204 120 023
			RLE				0 204 120 023
2.0 i RX4	06.99-04.03	101,5	LLE				0 204 120 023
			RLE				0 204 120 023
	02.01-04.03	102	LLE				0 204 120 023
			RLE				0 204 120 023
	1.4 i	11.96-04.03	55/70			0 204 031 295 ^A	
	1.6 i	01.96-04.03	55/66/79			0 204 031 295 ^A	
	1.8 i	09.00-04.03	85/88			0 204 031 295 ^A	
	1.9 D, D Turbo, DCI, DCI RX4, DTI	11.96-04.03	47-48/59/66-69/72/75			0 204 031 295 ^A	
	2.0 i, i RX4	11.96-04.03	83-84/101,5/102			0 204 031 295 ^A	
	1.4 i	11.96-02.99	55		BO	0 265 216 556 ^B	
		08.98-02.99	70			0 265 216 556 ^B	
		08.98-04.03	70			0 265 225 108 ^M	
		03.99-04.03	70			0 265 216 681 ^B	
	1.6 i	01.96-02.99	66		BO	0 265 216 556 ^B	
		11.96-02.99	55		BO	0 265 216 556 ^B	
		08.98-04.03	79			0 265 225 108 ^M	
		03.99-04.03	66		BO	0 265 216 681 ^B	
			79			0 265 216 681 ^B	
						0 265 225 108 ^M	
	1.8 i	09.00-04.03	85/88			0 265 216 681 ^B	
						0 265 225 108 ^M	
	1.9 D	03.99-04.03	47-48		BO	0 265 216 681 ^B	
	1.9 DCI	06.97-04.03	75			0 265 216 681 ^B	
	1.9 DCI RX4	06.97-03.02	75			0 265 220 545 ^H	
		04.02-04.03	75			0 265 220 669 ^I	
	1.9 DCI, DCI RX4	06.97-04.03	75			0 265 225 108 ^M	
	1.9 DTI	03.99-04.03	72		BO	0 265 216 681 ^B	
		11.00-04.03	59			0 265 216 681 ^B	
						0 265 225 108 ^M	
	2.0 i	11.96-04.03	83-84		BO	0 265 216 681 ^B	
03.99-04.03		101,5/102			0 265 216 681 ^B		
2.0 i RX4	06.99-03.02	101,5/102			0 265 220 545 ^H		
	04.02-04.03	101,5/102			0 265 220 669 ^I		
2.0 i, i RX4	03.99-04.03	101,5/102			0 265 225 108 ^M		
	1.4 i	11.96-04.03	55/70			0 265 005 263	
	1.6 i	01.96-04.03	55/66/79			0 265 005 263	
	1.8 i	09.00-04.03	85/88			0 265 005 263	
	1.9 D, D Turbo, DCI, DCI RX4, DTI	11.96-04.03	47-48/59/66-69/72/75			0 265 005 263	
	2.0 i, i RX4	11.96-04.03	83-84/101,5/102			0 265 005 263	



Scenic II [JM]

Icon	Engine	Period	Power	Part	Code	Price
	1.4 16V	05.03-04.09	72	BO	0 204 701 702	
				JBH TRW	0 986 481 002	23,81
	1.5 dCi	05.03-04.09	60-63/ 74-78	BO	0 204 701 702	
				JBH TRW	0 986 481 002	23,81
	1.6 16V	05.03-04.09	83	BO	0 204 701 702	
				JBH TRW	0 986 481 002	23,81
	1.9 dCi	05.03-04.09	81/88/96	BO	0 204 701 702	
				JBH TRW	0 986 481 002	23,81
	2.0 dCi, 16V, 16V Turbo	05.03-04.09	99/110/ 120	BO	0 204 701 702	
				JBH TRW	0 986 481 002	23,81
	1.4 16V	05.03-08.05	72		0 265 231 301 ^F	
		05.03-04.09	72		0 265 234 311 ^T	
		09.05-04.09	72		0 265 232 068 ^B	
	1.5 dCi	05.03-08.05	60-63 74-78		0 265 231 301 ^F	
		05.03-12.06	60-63		0 265 234 311 ^T	
		05.03-04.09	74-78		0 265 234 311 ^T	
		09.05-12.06	60-63		0 265 232 068 ^B	
			63		0 265 232 068 ^B	
					0 265 234 311 ^T	
		09.05-04.09	74-78		0 265 232 068 ^B	
	1.6 16V	05.03-08.05	83		0 265 231 301 ^F	
		05.03-04.09	83		0 265 234 311 ^T	
		09.05-04.09	83		0 265 232 068 ^B	
	1.9 dCi	05.03-08.05	88 96		0 265 231 301 ^F	
		05.03-04.09	88 96		0 265 234 311 ^T	
		05.05-09.06	81 96		0 265 234 311 ^T	
		05.05-11.08	96		0 265 232 068 ^B	
		09.05-11.08	81		0 265 232 068 ^B	
		09.05-04.09	88 96		0 265 232 068 ^B	
		10.06-11.08	81 96		0 265 234 680 ^T	
					0 265 234 680 ^T	
	2.0 dCi	09.04-04.09	110		0 265 232 068 ^B	
					0 265 234 511 ^T	
		10.06-04.09	110		0 265 234 680 ^T	
	2.0 16V	05.03-08.05	99		0 265 231 301 ^F	
		05.03-04.09	99		0 265 234 311 ^T	
		09.05-04.09	99		0 265 232 068 ^B	
	2.0 16V Turbo	06.03-08.05	120		0 265 231 301 ^F	
		06.03-04.09	120		0 265 234 311 ^T	
		09.05-04.09	120		0 265 232 068 ^B	
	1.4 16V	05.03-04.09	72		0 265 005 263	
	1.5 dCi	05.03-04.09	60-63/74-78		0 265 005 263	
	1.6 16V	05.03-04.09	83		0 265 005 263	
	1.9 dCi	05.03-04.09	81/88/96		0 265 005 263	
	2.0 dCi, 16V, 16V Turbo	05.03-04.09	99/110/120		0 265 005 263	

Scenic III [JZ]

Icon	Engine	Period	Power	Part	Code	Price
	1.6 dCi	03.11→	96		0 986 486 615	30
	1.9 dCi	05.09→	96		0 986 486 615	30





◀ RENAULT

Sport Spider



	2.0	05.96-10.99	108-110			0 204 123 072	23,8
--	-----	-------------	---------	--	--	---------------	------

Thalia [LB]



	1.0 i 16V	A	A	ABO	06.01-11.04	50		BSY	F 026 003 418	20,64	
								JBH	ATE 0 986 480 984	20,6	
					ABS	06.01-11.04	50		F 026 003 417	20,64	
	1.2 i 16V	A	A	ABO	09.01-03.04	55		BSY	F 026 003 418	20,64	
								JBH	ATE 0 986 480 984	20,6	
							09.01-10.07	55	JBH	F 026 003 180	20,6
						ABS	09.01-10.07	55		F 026 003 417	20,64
	1.4 i	A	A	ABO	10.99-10.07	55/70-72		BSY	F 026 003 418	20,64	
								JBH	ATE 0 986 480 984	20,6	
	1.4 i 16V							BSY	F 026 003 180	20,6	
									F 026 003 417	20,64	
	1.5 dCi	A	A	ABO	06.01-10.07	59/60		JBH	F 026 003 180	20,6	
					09.01-10.07	48		BSY	F 026 003 418	20,64	
								JBH	ATE 0 986 480 984	20,6	
								BSY	F 026 003 180	20,6	
	1.6 i	A	A	ABS	06.01-10.07	59		BSY	F 026 003 417	20,64	
								JBH	ATE 0 986 481 036	20,64	
					09.01-10.07	48			F 026 003 417	20,64	
					05.04-10.07	60			F 026 003 417	20,64	
					11.01-10.07	66			F 026 003 417	20,64	
				A	ABO	10.99-10.07	66		BSY	F 026 003 418	20,64
	1.6 i				06.01-10.07	81		JBH	ATE 0 986 480 984	20,6	
								BSY	F 026 003 418	20,64	
					11.01-10.07	66		JBH	ATE 0 986 480 984	20,6	
					11.04-10.07	66		LLE	BSY F 026 003 418	20,64	
								JBH,LLE	ATE 0 986 480 984	20,6	
								RLE	0 204 123 416	20,64	
									F 026 003 417	20,64	
									F 026 003 417	20,64	
	1.9 D	A	A	ABO	10.99-10.07	47-48		BSY	F 026 003 418	20,64	
								JBH	ATE 0 986 480 984	20,6	
									F 026 003 417	20,64	

	1.0 i 16V	06.01-11.04	50			BO	0 204 125 733	0 204 120 023
	1.2 i	06.01-10.07	43			LLE	0 204 125 733	0 204 120 023
	1.2 i 16V	09.01-10.07	55			BO	0 204 125 733	0 204 120 023
	1.4 i, i 16V	10.99-10.07	55/70-72			BO	0 204 125 733	0 204 120 023
	1.5 dCi	06.01-10.07	48/59			BO	0 204 125 733	0 204 120 023
	1.6 i	10.99-10.07	66			BO	0 204 125 733	0 204 120 023
		06.01-10.07	81			BO	0 204 125 733	0 204 120 023
		11.04-10.07	66				0 204 125 733	0 204 120 023
	1.9 D	10.99-10.07	47-48			BO	0 204 125 733	0 204 120 023

	1.0 i 16V	06.01-11.04	50				0 204 031 296 ^A
	1.2 i, i 16V	06.01-10.07	43/55				0 204 031 296 ^A
	1.4 i, i 16V	10.99-10.07	55/70-72				0 204 031 296 ^A
	1.5 dCi	06.01-10.07	48/50/59/60				0 204 031 296 ^A
	1.6 i	10.99-10.07	66/81				0 204 031 296 ^A
	1.9 D	10.99-10.07	47-48				0 204 031 296 ^A



		S								
	1.0 i 16V	06.01-11.04	50				0 265 231 334 ^B			
					44Z		0 265 225 260 ^T			
	1.2 i	06.01-11.02	43				0 265 216 873 ^B			
		12.02-10.07	43				0 265 231 334 ^B			
	1.2 i 16V	09.01-11.02	55				0 265 216 873 ^B			
		12.02-10.07	55				0 265 231 334 ^B			
		04.04-10.07	55		44Z		0 265 225 260 ^T			
	1.4 i	10.99-08.00	55				0 265 216 703 ^B			
		09.00-11.02	55				0 265 216 873 ^B			
		12.02-10.07	55				0 265 231 334 ^B			
	1.4 i 16V	06.01-11.02	70-72				0 265 216 873 ^B			
		12.02-10.07	70-72				0 265 231 334 ^B			
	1.5 dCi	06.01-10.07	59/60		44Z		0 265 225 260 ^T			
		09.01-11.02	48				0 265 216 873 ^B			
		12.02-10.07	48				0 265 231 334 ^B			
10.05-10.07		50				0 265 231 334 ^B				
1.6 i					44Z	0 265 225 260 ^T				
	10.99-11.02	66				0 265 216 703 ^B				
	06.01-10.07	81				0 265 231 334 ^B				
					44Z	0 265 225 260 ^T				
	11.01-11.02	66				0 265 216 873 ^B				
1.9 D	12.02-10.07	66				0 265 231 334 ^B				
	01.04-10.07	66		44Z		0 265 225 260 ^T				
	10.99-11.02	47-48				0 265 216 703 ^B				
	12.02-10.07	47-48				0 265 231 334 ^B				
	1.0 i 16V	06.01-11.04	50				0 265 005 263			
	1.2 i, i 16V	06.01-10.07	43/55				0 265 005 263			
	1.4 i, i 16V	10.99-10.07	55/70-72				0 265 005 263			
	1.5 dCi	06.01-10.07	48/50/59/60				0 265 005 263			
	1.6 i	10.99-10.07	66/81				0 265 005 263			
1.9 D	10.99-10.07	47-48				0 265 005 263				
Thalia [LU]										
	1.2	ABO 10.08→	55		JBH		F 026 003 180	20,6		
		ABS 10.08→	55				F 026 003 417	20,64		
	1.4	ABO 10.08→	72		JBH		F 026 003 180	20,6		
		ABS 10.08→	72		JBH		0 986 481 036	20,64		
	1.5 dCi	ABO 10.08→	47/62		JBH		F 026 003 180	20,6		
		ABS 10.08→	47/62		JBH		0 986 481 036	20,64		
	1.6	ABO 10.08→	77		JBH		F 026 003 180	20,6		
		ABS 10.08→	77		JBH		0 986 481 036	20,64		
		1.2	10.08→	55				0 204 032 621		
		1.4	10.08→	72			ATE		0 204 120 023	
						BO	0 204 125 733	0 204 120 023		
1.5 dCi		10.08→	47/62			ATE		0 204 120 023		
						BO	0 204 125 733	0 204 120 023		
1.6		10.08→	77			ATE		0 204 120 023		
					BO	0 204 125 733	0 204 120 023			
	1.2	10.08→	55				0 204 031 296 ^A			
	1.4	10.08→	72				0 204 031 296 ^A			
	1.5 dCi	10.08→	47/62				0 204 031 296 ^A			
	1.6	10.08→	77				0 204 031 296 ^A			
	1.2	10.08→	55				0 265 232 372 ^B			
	1.4	10.08→	72				0 265 232 372 ^B			
	1.5 dCi	10.08→	47/62				0 265 232 372 ^B			
	1.6	10.08→	77				0 265 232 372 ^B			





◀ RENAULT

Traffic



	1.4		09.80-10.97	36	JBH,KW,LLE	0 986 480 902	20
					JBH,KW,RLE	0 986 480 913	23
	1.7		10.84-09.94	58	JBH	0 986 480 913	23
			03.89-09.94	50	JBH	0 986 480 913	23
			03.89-10.97	50	JBH,KW,LLE	0 986 480 902	20
				50	JBH,KW,RLE	0 986 480 913	23
1.9 D	ABO	11.97-05.01	47-48	JBH	F 026 003 410	23,81	
		ABS	11.97-05.01	47-48		0 204 123 409	
2.0		09.80-10.97	59	JBH	0 986 480 913	23	
2.1 D		09.80-09.94	43-44	JBH	0 986 480 913	23	
			03.89-10.97	43-44	JBH,KW,LLE	0 986 480 902	20
		09.94-10.97	47	JBH,KW,RLE	0 986 480 913	23	
			47	JBH	0 986 480 913	23	
2.2 i	ABO	09.94-10.97	74	JBH,TW	0 986 480 916	25,4	
2.5 D		03.89-10.97	55	JBH	0 986 480 916	25,4	
			55	JBH,TW	0 986 480 913	23	
					0 986 480 916	25,4	
2.5 D	ABO	11.97-05.01	55		0 204 123 651	23,8	
2.5 D 4x4	ABS	11.97-05.01	55		0 204 123 409		

	1.9 D		11.97-05.01	47-48			0 204 120 023
	2.5 D, D 4x4		11.97-05.01	55		0 204 125 580	0 204 120 023

	2.0		09.80-10.97	59		0 204 162 024	
	2.1 D		09.80-10.97	43-44/47		0 204 162 024	
	2.2 i		03.89-10.97	69-71/74		0 204 162 024	
	2.5 D		03.89-10.97	55		0 204 162 024	
				55		0 204 162 024	

	1.4		09.80-10.97	36		0 986 482 002^A	
	1.7		10.84-10.97	50/58		0 986 482 002^A	
	1.9 D		11.97-05.01	47-48		0 986 482 002^A	
	2.0		09.80-10.97	59		0 986 482 002^A	
	2.1 D		09.80-10.97	43-44/47		0 986 482 002^A	
	2.2 i		03.89-10.97	69-71/74		0 986 482 002^A	
	2.5 D, D 4x4		03.89-05.01	55		0 986 482 002^A	
				55		0 986 482 002^A	

	1.4		09.80-10.97	36		0 265 105 038^H	
	1.7		03.89-10.97	50		0 265 105 038^H	
	1.9 D		11.97-05.01	47-48		0 265 105 038^H	
	2.0		09.80-10.97	59		0 265 105 038^H	
	2.1 D		09.80-10.97	43-44/47		0 265 105 038^H	
	2.2 i		03.89-10.97	69-71/74		0 265 105 038^H	
	2.5 D, D 4x4		03.89-05.01	55		0 265 105 038^H	
				55		0 265 105 038^H	

Traffic II [EL/FL/JL]



	1.9 dCi	ABO	05.01-09.03	60/74	JBH	0 986 480 887	20,6	
			05.01-09.03	60/74	JBH	0 986 480 831	25,4	
			OFD					
			MFD	05.01-12.06	60/74	JBH	0 986 480 827	25,4
			OFD	10.03-12.06	60/74	JBH,LLE	0 986 480 999	20,64
	2.0		10.03-12.06	88	JBH,RLE	0 986 480 828	25,4	
				88	JBH	0 986 480 828	25,4	
				88	JBH	0 986 480 887	20,6	
	2.0	ABS	06.01-09.03	88	JBH	0 986 480 831	25,4	
			88	JBH	0 986 480 831	25,4		
2.0	MFD	01.06→	66/84/85/86		0 986 481 051	20,6		
2.0 dCi	OFD	01.06→	66/84/85/86		0 986 481 050	20,6		



2.5 dCi		10.03-12.06	98		JBH	0 986 480 828	25,4
	ABO	06.02-09.03	98		JBH	0 986 480 887	20,6
	ABS	06.02-09.03	98		JBH	0 986 480 831	25,4
	MFD	01.06→	107			0 986 481 051	20,6
	OFD	01.06→	107			0 986 481 050	20,6

	1.9 dCi	05.01-12.06	60/74		LLE	0 986 486 147	15,87
	2.0, dCi	06.01→	66/84/85/86/88		LLE	0 986 486 147	15,87
	2.5 dCi	06.02→	98/107		LLE	0 986 486 147	15,87

	1.9 dCi	05.01-12.06	60		TW	0 986 486 596	27
		06.01-12.06	74			0 986 486 596	27
	2.0	06.01→	86/88			0 986 486 596	27

Twingo I [C0./S0.]

	1.0 i	ABO	01.00-05.07	43/50		JBH	F 026 003 151	20,6
	1.0 i 16V	ABS	01.00-05.07	43/50			0 204 123 678	20,6
	1.2 i	ABO	03.93-05.07	40-44/55		JBH	F 026 003 151	20,6
	1.2 i 16V	ABS	03.93-05.07	40-44/55			0 204 123 678	20,6

	1.0 i, i 16V		01.00-05.07	43/50				0 204 120 023
	1.2 i	ABO	03.93-02.96	40			0 204 125 111	0 204 120 023
			01.96-04.98	43	Fg.-Nr. C066		0 204 125 527	0 204 120 023
			01.96-05.07	43	Fg.-Nr. C06G		0 204 125 770	0 204 120 023
			03.96-05.96	40			0 204 125 146	0 204 120 023
			06.96-08.97	40			0 204 125 527	0 204 120 023
			09.96-04.98	40-44			0 204 125 527	0 204 120 023
			05.98-05.07	40-44				0 204 120 023
				43				0 204 120 023
			09.98-05.07	43			0 204 125 770	0 204 120 023
		ABS	03.93-05.96	40				0 204 120 023
			01.96-04.98	43	Fg.-Nr. C066		0 204 125 528	0 204 120 023
			01.96-11.01	43	Fg.-Nr. C06G		0 204 125 771	0 204 120 023
			06.96-08.97	40			0 204 125 528	0 204 120 023
			09.96-04.98	40-44			0 204 125 528	0 204 120 023
			05.98-05.07	40-44				0 204 120 023
				43				0 204 120 023
			09.98-11.01	43			0 204 125 771	0 204 120 023
			12.01-05.07	43			0 204 125 794	0 204 120 023
	1.2 i 16V		10.03-05.07	55			0 204 125 802	0 204 120 023
	ABO	09.00-05.07	55			0 204 125 770	0 204 120 023	
					FEN	0 204 125 770	0 204 120 023	
					FEV		0 204 120 023	
	ABS	09.00-11.01	55			0 204 125 771	0 204 120 023	
					FEN	0 204 125 771	0 204 120 023	
		09.00-05.07	55		FEV		0 204 120 023	
		12.01-05.07	55			0 204 125 794	0 204 120 023	
					FEN	0 204 125 794	0 204 120 023	

	1.0 i, i 16V		01.00-05.07	43/50			0 204 131 177 ^A
	1.2 i, i 16V		03.93-05.07	40-44/55			0 204 131 177 ^A

	1.2 i		12.02-05.07	43/55			0 265 231 334 ^B
	1.2 i 16V						

Twingo II [CN/GN]

	1.2, TCe, 16V	OFD	04.07→	43/56/74-75		JBH,LLE	0 986 481 031	20,64
	1.5 dCi	OFD	04.07→	47/55/62/63		JBH,LLE	0 986 481 031	20,64



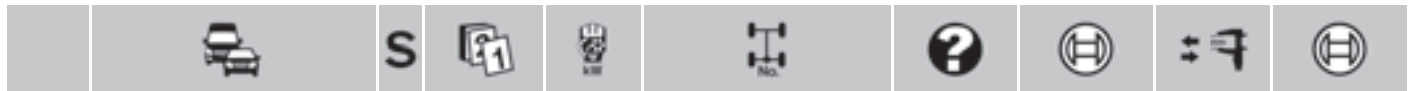

◀RENAULT Twingo II [CN/GN]

	1.2, TCe, 16V	06.08→	43/56/74-75		0 265 251 867 ^T
	1.5 dCi	06.08→	47/55/62/63		0 265 251 867 ^T
	1.6 R.S.	06.08→	98		0 265 251 867 ^T
	1.2, TCe, 16V	04.07-10.08	43/56/74-75		0 265 005 701
		11.08→	43/56/74-75		0 265 005 811
	1.5 dCi	04.07-10.08	47		0 265 005 701
		11.08→	47		0 265 005 811
	1.6 R.S.	04.10→	55/62/63		0 265 005 811
		07.07-10.08	98		0 265 005 701
	11.08→	98		0 265 005 811	

Wind [E4]

	1.2	04.10→	74-75		0 265 251 867 ^T
	1.6	04.10→	98		0 265 251 867 ^T
	1.2	04.10→	74-75		0 265 005 811
	1.6	04.10→	98		0 265 005 811

5

	1.0	10.84-12.96	30	JBH,LLE	F 026 003 078	17,5
				JBH,RLE BSY	F 026 003 103	19
	1.1	10.84-12.96	33	JBH	F 026 003 103	19
	1.2	10.84-12.96	40	JBH	F 026 003 103	19
	1.4i, Turbo	10.84-12.96	43/44/49/50/77/88	JBH	F 026 003 103	19
	1.6 D	10.87-12.96	40	JBH	F 026 003 103	19
	1.7, i	10.86-12.96	55/66/69	JBH	F 026 003 103	19
	1.0	10.84-12.96	30	RLE	0 204 125 049	
				LLE	0 204 125 047	
	1.1	10.84-12.96	33	RLE	0 204 125 049	
				LLE	0 204 125 047	
	1.2	10.84-12.96	40	LLE	0 204 125 047	
				RLE	0 204 125 049	
	1.4	10.84-12.96	43	LLE	0 204 125 047	
				RLE	0 204 125 049	
			44/49	LLE	0 204 125 047	
				06.87-12.96	44/49	
	50	LLE	0 204 125 047			
		RLE	0 204 125 049			
	1.4, i	10.84-12.96	44/49	RLE	0 204 125 049	
	1.4 i	10.85-12.96	44/49	LLE	0 204 125 047	
	1.6 D	10.87-12.96	40	LLE	0 204 125 047	
				RLE	0 204 125 049	
	1.7 i	10.86-12.96	55		0 204 125 047	
	1.0	10.84-12.96	30		0 204 131 140 ^A	
	1.1	10.84-12.96	33		0 204 131 140 ^A	
	1.2	10.84-12.96	40		0 204 131 140 ^A	
	1.4	10.84-12.96	43		0 204 131 140 ^A	
			49		0 204 131 140 ^A	
	50	06.87-12.96			0 204 131 140 ^A	
	1.4 Turbo	06.87-12.96	77/88	LLE	0 204 131 042 ^A	
	1.6 D	10.87-12.96	40		0 204 131 140 ^A	
	1.7	06.87-12.96	66		0 204 131 140 ^A	
	1.7 i	10.86-12.96	55		0 204 131 140 ^A	
			69		0 204 131 042 ^A	
	69	06.87-12.96		RLE	0 204 131 047 ^A	



9 [L42]

	1.4		01.85-12.95	44/49-53				F 02D 020 009
					JBH	F 026 003 012	19	
	1.4		01.85-12.95	44/49-53		0 204 125 041		

11 [B37]

	1.4		01.85-03.95	49-53	JBH	F 026 003 012	19	
	1.7		01.85-03.95	65	JBH	F 026 003 012	19	
	1.4		01.85-03.95	49-53		0 204 125 041		
	1.7		01.85-03.95	65		0 204 125 041		
	1.4		01.85-03.95	49-53		0 204 131 028		
	1.7		01.85-03.95	65		0 204 131 028		

19 Cabrio [X53]

	1.7 i	ABO	02.92-12.95	66-70	JBH	ATE	F 026 003 180	20,6
		ABS	09.88-12.95	66-70	GS	BSY	0 204 123 176	20,6
	1.8 i		09.94-12.95	79	JBH		F 026 003 180	20,6
		ABO	05.92-12.95	65-66/79-83	JBH	ATE	F 026 003 180	20,6
		ABS	05.92-12.95	65-66/79-83	GS	BSY	0 204 123 176	20,6
	1.8 i 16V	ABO	06.89-12.95	99-101	JBH,LLE	BSY	F 026 003 180	20,6
	1.7 i	ABO	09.88-12.95	66-70	RLE	ATE	0 986 485 106	
		ABS	09.88-12.95	66-70	LLE	BSY	0 204 125 149	
					RLE	BSY	0 204 125 151	
	1.8 i	ABS	05.92-12.95	65	LLE	BSY	0 204 125 149	
			09.94-12.95	65-66/79-83	RLE	BSY	0 204 125 151	
	1.8 i, i 16V	ABO	06.89-12.95	65/99-101	RLE	ATE	0 986 485 106	
	1.8 i 16V		06.89-12.95	99-101	LLE		0 204 125 149	
		ABS	06.89-12.95	99-101	RLE	BSY	0 204 125 151	
	1.8 i	ABO	09.94-12.94	79-83			0 204 131 164^A	
			01.95-12.95	79-83			0 204 131 183^A	

19 [X53]

	1.2, i		02.92-12.01	40/46	JBH		F 026 003 180	20,6
	1.4		09.88-12.01	43	JBH		F 026 003 103	19
			02.92-12.01	43	JBH		F 026 003 180	20,6
	1.4, i	ABO	02.92-12.01	55-59	JBH	ATE	F 026 003 180	20,6
	1.4 i		02.92-12.01	40-44	JBH,LLE	BSY	F 026 003 180	20,6
		ABS	05.90-12.01	55-59	GS	BSY	0 204 123 176	20,6
	1.7	ABO	09.88-12.95	55-56	JBH	ATE	F 026 003 103	19
	1.7	ABO	02.92-12.95	66-70	JBH	ATE	F 026 003 180	20,6
	1.7 i	ABS	09.88-12.95	54/66-70	GS	BSY	0 204 123 176	20,6
	1.7 i	ABO	02.92-12.95	54	JBH	ATE	F 026 003 180	20,6
	1.8 i	ABO	05.92-12.95	65-66/79-83	JBH	ATE	F 026 003 180	20,6
		ABS	05.92-12.95	65-66/79-83	GS	BSY	0 204 123 176	20,6
	1.8 i 16V		02.92-12.95	99-101	JBH		F 026 003 180	20,6
	1.9 D	ABS	09.88-12.01	47	GS	BSY	0 204 123 176	20,6



		S							
RENAULT 19 [X53]									
	1.9 D Turbo	ABS	10.95-12.01	66-68		BSY	0 204 123 176	20,6	
	1.9 D, D Turbo	ABO	02.92-12.01	47/66-68	JBH	ATE	F 026 003 180	20,6	
	1.4 i	ABO	09.88-12.01	55-59		RLE	ATE 0 986 485 106		
	1.4 i	ABS	05.90-12.01	55-59		LLE	BSY 0 204 125 149		
						RLE	BSY 0 204 125 151		
	1.7	ABO	09.88-12.95	55-56/66-70		RLE	ATE 0 986 485 106		
	1.7 i	ABS	09.88-12.95	66-70		LLE	BSY 0 204 125 149		
						RLE	BSY 0 204 125 151		
	1.7 i	ABS	09.88-12.95	54		LLE	BSY 0 204 125 149		
	1.8 i	ABS	05.92-12.95	65		LLE	BSY 0 204 125 149		
				79-83		RLE	BSY 0 204 125 151		
						LLE	BSY 0 204 125 149		
						RLE	BSY 0 204 125 151		
	1.8 i	ABO	06.89-12.95	65/79-83/		RLE	ATE 0 986 485 106		
	1.8 i 16V			99-101					
	1.8 i 16V		06.89-12.95	99-101		LLE	0 204 125 149		
		ABS	06.89-12.95	99-101		RLE	BSY 0 204 125 151		
	1.9 D	ABS	09.88-12.01	47		LLE	BSY 0 204 125 149		
						RLE	BSY 0 204 125 151		
	1.9 D Turbo	ABS	10.95-12.01	66-68		LLE	BSY 0 204 125 149		
						RLE	BSY 0 204 125 151		
	1.9 D, D Turbo	ABO	09.88-12.01	47/66-68		RLE	ATE 0 986 485 106		
	1.7 i	ABO	06.89-12.94	66-70			0 204 131 164 ^A		
			01.95-12.95	66-70			0 204 131 183 ^A		
	1.8 i	ABO	05.92-12.94	79-83			0 204 131 164 ^A		
			09.94-12.95	79-83			0 204 131 183 ^A		
	1.8 i 16V		05.92-12.95	99-101			0 204 131 162 ^A		
	1.9 D Turbo	ABO	09.90-12.94	68			0 204 131 164 ^A		
			05.92-12.94	66			0 204 131 164 ^A		
			09.94-12.01	66-68			0 204 131 183 ^A		
			01.95-07.95	68			0 204 131 183 ^A		
			01.95-12.01	66			0 204 131 183 ^A		
21 [L48]									
	1.4		06.88-12.94	49-50	JBH	ATE	0 986 480 774	22,2	
			06.90-12.94	49-50	JBH	ATE	F 026 003 257	20,6	
	1.7, i		06.92-12.94	54/64/65/66-70	JBH	ATE	F 026 003 257	20,6	
	1.9 D		04.92-12.94	48	JBH	ATE	F 026 003 103	19	
	2.0 i		06.90-12.94	88	JBH		F 026 003 257	20,6	
		ABO	05.89-12.94	100	JBH	ATE	0 986 480 774	22,2	
			06.90-12.94	88	JBH,LLE	ATE	0 986 480 774	22,2	
	2.1 D Turbo	ABO	04.92-12.94	65-68	JBH	ATE	F 026 003 257	20,6	
							0 986 480 774	22,2	
	2.1 D, D Turbo	ABO	06.91-12.94	46-56/65	JBH	ATE	0 986 480 774	22,2	
	2.2		05.89-12.94	85	JBH	ATE	0 986 480 774	22,2	
	2.2 i	ABO	05.89-12.94	79-81	JBH,LLE	ATE	0 986 480 774	22,2	
	1.9 D		04.92-12.94	48			0 204 125 055		
	2.2 i		07.86-12.94	79-81	Fg.-Nr. →S4999	AA,LLE	0 204 162 037		
	2.2 i		07.86-12.94	79-81	Fg.-Nr. →S4999	AA,LLE	0 204 163 025		



21 Nevada [K48]

	1.4	06.88-12.95	51		JBH	F 026 003 103	19
	1.7	06.90-12.95	65		JBH	0 986 480 774	22,2
			68-70		JBH	0 986 480 774	22,2
	1.7, i	06.86-12.95	53-60		JBH	F 026 003 103	19
	1.7i	06.86-12.95	66-70		JBH	F 026 003 103	19
	1.9D	05.89-12.95	48		JBH	F 026 003 103	19
	2.0	05.89-12.95	76		JBH	0 986 480 774	22,2
	2.0i	10.86-12.95	85-88		JBH	ATE 0 986 480 774	22,2
						GIR F 026 003 257	20,6
		ABO 06.90-12.95	88		JBH,LLE	ATE 0 986 480 774	22,2
					JBH,RLE	ATE F 026 003 257	20,6
		06.91-12.95	99-100		JBH	0 986 480 774	22,2
	2.1D	10.86-12.95	49		JBH	ATE 0 986 480 774	22,2
						GIR F 026 003 257	20,6
		05.89-12.95	53-54		JBH	0 986 480 774	22,2
		ABO 04.92-12.95	51-54		JBH	0 986 480 774	22,2
	2.1D Turbo	07.89-12.95	65		JBH	0 986 480 774	22,2
		ABO 05.89-12.95	65		JBH	0 986 480 774	22,2
	2.2i	10.86-12.95	79-81		JBH	ATE 0 986 480 774	22,2
						GIR F 026 003 257	20,6
		ABO 04.93-12.95	79-81		JBH	0 986 480 774	22,2

	1.4	06.88-12.95	51			0 204 125 055	
	1.9D	05.89-12.95	48			0 204 125 055	

ROLLS-ROYCE

Ghost [RR4]

	6.6	12.09→	420/442		JBH	0 986 481 012	
	6.6 V-Specification						

Phantom Coupé [RR3]

	6.8	09.08→	338		JBH	0 986 481 026	27
	6.8	09.08→	338			0 265 225 414 ^T	
	6.8	09.08→	338			0 265 005 285	
	6.8	09.08→	338			0 265 005 303	





























Phantom Drophead [RR2]

	6.8	06.07→	338		JBH	0 986 481 026	27
	6.8	06.07→	338			0 265 225 414 ^T	



		S							
◀ ROLLS-ROYCE Phantom Drophead [RR2]									
	6.8	06.07→	338				0 265 005 285		
	6.8	06.07→	338				0 265 005 303		
Phantom [RR1]									
	6.8	03.03→	338		JBH		0 986 481 026	27	
	6.8	03.03→	338				0 265 225 414 ^T		
	6.8	03.03→	338				0 265 005 285		
	6.8	03.03→	338				0 265 005 303		
Phantom VI									
	6.8	07.89-12.99					0 265 103 044 ^H		
Wraith [RR5]									
	6.6	08.13→	465		JBH		0 986 481 012		
ROVER									
Mini									
	1.3 1.3 i	02.90-09.00	39-46	Fg.-Nr. 290003→295668 Fg.-Nr. 295669→396448	JBH JBH		0 986 480 625 0 986 480 625	17,5 17,5	
	1.3 1.3 i	02.90-09.00	39-46	Fg.-Nr. 396449→, XN 010001→			0 986 485 088		
	1.3 1.3 i	02.90-09.00	39-46				0 986 482 017		
Mini Cabrio									
	1.3 1.3 i	02.90-09.00	39-46	Fg.-Nr. 290003→295668 Fg.-Nr. 295669→396448	JBH JBH		0 986 480 625 0 986 480 625	17,5 17,5	
	1.3 1.3 i	02.90-09.00	39-46	Fg.-Nr. 396449→, XN 010001→			0 986 485 088		
	1.3 1.3 i	02.90-09.00	39-46				0 986 482 017		



		S							
Mini Cooper									
									
	1.3 i	09.94-09.96	59	Fg.-Nr. 290003→295668 Fg.-Nr. 295669→396448	JBH JBH		0 986 480 625 0 986 480 625	17,5 17,5	
	1.3 i	09.94-09.96	59	Fg.-Nr. 396449→, XN 010001→			0 986 485 088		
	1.3 1.3 i	02.90-09.00	39-46/59				0 986 482 017		
Mini Cooper Cabrio									
									
	1.3 i	09.94-09.96	59	Fg.-Nr. 290003→295668 Fg.-Nr. 295669→396448	JBH JBH		0 986 480 625 0 986 480 625	17,5 17,5	
	1.3 i	09.94-09.96	59	Fg.-Nr. 396449→, XN 010001→			0 986 485 088		
	1.3 1.3 i	02.90-09.00	39-46/59				0 986 482 017		
Mini De Ville									
									
	1.3 i	09.94-09.96	59	Fg.-Nr. 290003→295668 Fg.-Nr. 295669→396448	JBH JBH		0 986 480 625 0 986 480 625	17,5 17,5	
	1.3 i	09.94-09.96	59	Fg.-Nr. 396449→, XN 010001→			0 986 485 088		
	1.3 i	09.94-09.96	59				0 986 482 017		
Mini De Ville Cabrio									
									
	1.3 i	09.94-09.96	59	Fg.-Nr. 290003→295668 Fg.-Nr. 295669→396448	JBH JBH		0 986 480 625 0 986 480 625	17,5 17,5	
	1.3 i	09.94-09.96	59	Fg.-Nr. 396449→, XN 010001→			0 986 485 088		
	1.3 i	09.94-09.96	59				0 986 482 017		
Mini Margrave									
									
	1.4 i	09.95-09.00	77	Fg.-Nr. 290003→295668 Fg.-Nr. 295669→396448	JBH JBH		0 986 480 625 0 986 480 625	17,5 17,5	
	1.4 i	09.95-09.00	77	Fg.-Nr. 396449→, XN 010001→			0 986 485 088		
	1.4 i	09.95-09.00	77				0 986 482 017		





◀ ROVER

Mini Retro Rally



	1.3 i	09.94-09.96	60	Fg.-Nr. 290003→295668	JBH	0986 480 625	17,5
				Fg.-Nr. 295669→396448	JBH	0986 480 625	17,5
	1.3 i	09.94-09.96	60	Fg.-Nr. 396449→, XN010001→		0986 485 088	
	1.3 i	09.94-09.96	60			0986 482 017	









Serie 200



	211 i	ABO	11.95-03.00	44-45	Fg.-Nr. →YD 553014	JBH	0986 480 873	
	214 Cabrio	ABO	10.92-02.96	66-70		LLE	0986 480 676	22,2
						JBH,RLE	0986 480 622	22,2
	214 Cabrio, i, Si 16V, Si 16V Cabrio	ABS	10.92-11.99	55/66-70/76			0986 480 670	22,2
	214 i	ABO	01.93-02.96	55		LLE	0986 480 676	22,2
						JBH,RLE	0986 480 622	22,2
			10.95-03.00	55	Fg.-Nr. →YD 553014	JBH	0986 480 873	
	214 Si 16V	ABO	10.92-02.96	76		LLE	0986 480 676	22,2
	214 Si 16V Cabrio	ABO	10.92-02.96	76		LLE	0986 480 676	22,2
			03.96-03.96	76		JBH	0986 480 873	
	214 Si 16V, Si 16V Cabrio	ABO	10.92-02.96	76		JBH,RLE	0986 480 622	22,2
	214 16V Coupé	ABO	10.95-03.00	76	Fg.-Nr. →YD 553014	JBH	0986 480 873	
	216 GTi 16V, GTi 16V Cabrio, i 16V, i 16V Coupé	ABO	10.89-02.96	82-85/ 90-96		LLE	0986 480 676	22,2
		ABS	10.89-02.96	82-85/90-96		JBH,RLE	0986 480 622	22,2
	216 i 16V Cabrio, i 16V Coupé	ABO	03.96-03.00	82		JBH	0986 480 873	
	216 16V	ABO	10.95-03.00	82	Fg.-Nr. →YD 553014	JBH	0986 480 873	
	218 D Turbo, 1.9 D	ABS	11.92-02.96	52/65		LLE	0986 480 671	22,2
	218 i 16V	ABO	09.95-03.00	107	Fg.-Nr. →YD 553014	JBH	0986 480 873	
					Fg.-Nr. →YD 553014	JBH	0986 480 873	
	218 i 16V Coupé	ABO	03.96-03.00	107		JBH	0986 480 873	
	220 GTi 16V, GTi/GSi, i Turbo, i Turbo Coupé	ABO	03.96-06.96	100/103/147		JBH	0986 480 873	
	220 SD	ABO	09.95-03.00	63/77	Fg.-Nr. →YD 553014	JBH	0986 480 873	
	220 SDI		03.96-03.00	63/77		JBH	0986 480 873	
		ABS	09.95-02.96	63/77		LLE	0986 480 671	22,2

	211 i	ABS	11.95-02.96	44-45			0986 485 126	
	214 Cabrio, i, Si 16V, Si 16V Cabrio, 16V Coupé	ABS	10.92-02.96	55/66-70/76			0986 485 126	
	216 GTi 16V, GTi 16V Cabrio, i 16V, i 16V Coupé, 16V	ABS	10.89-02.96	82-85/90-96			0986 485 126	
	218 D Turbo, i 16V, 1.9 D	ABS	10.92-02.96	52/65/107			0986 485 126	
	220 GTi 16V, GTi/GSi, i Turbo, i Turbo Coupé, SD, SDI	ABS	09.91-02.96	63/77/100/ 103/147			0986 485 126	

	211 i	11.95-09.98	44-45	Fg.-Nr. →WD 267263		0265 216 043^B	
		10.97-03.00	44-45	Fg.-Nr. WD 267264→YD 471564		0265 216 520^B	
		09.99-03.00	44-45	Fg.-Nr. YD 471565→		0265 216 685^B	
	214 Cabrio	10.92-02.96	66-70	Fg.-Nr. 470611→712590		0265 208 002^H	
		11.92-02.96	66-70	Fg.-Nr. 712591→		0265 208 032^H	
	214 i	01.93-02.96	55	Fg.-Nr. 470611→712590		0265 208 002^H	
				Fg.-Nr. 712591→		0265 208 032^H	
		10.95-09.98	55	Fg.-Nr. →WD 267263		0265 216 043^B	
		10.97-03.00	55	Fg.-Nr. WD 267264→YD 471564		0265 216 520^B	
		09.99-03.00	55	Fg.-Nr. YD 471565→		0265 216 685^B	

		S							
214 Si 16V		11.92-02.96	76		Fg.-Nr. 712591→		0 265 208 032 ^H		
214 Si 16V Cabrio		11.92-02.96	76		Fg.-Nr. 712591→		0 265 208 032 ^H		
		03.96-03.96	76				0 265 216 043 ^B		
214 Si 16V, Si 16V Cabrio		10.92-02.96	76		Fg.-Nr. 470611→712590		0 265 208 002 ^H		
214 16V Coupé		10.95-09.98	76		Fg.-Nr. →WD 267263		0 265 216 043 ^B		
		10.97-03.00	76		Fg.-Nr. WD 267264→YD 471564		0 265 216 520 ^B		
		09.99-03.00	76		Fg.-Nr. YD 471565→		0 265 216 685 ^B		
216 i 16V Cabrio, i 16V Coupé		03.96-03.00	82				0 265 216 043 ^B		
216 16V		10.95-09.98	82		Fg.-Nr. →WD 267263		0 265 216 043 ^B		
		10.97-03.00	82		Fg.-Nr. WD 267264→YD 471564		0 265 216 520 ^B		
		09.99-03.00	82		Fg.-Nr. YD 471565→		0 265 216 685 ^B		
218 D Turbo		10.92-02.96	52/65		Fg.-Nr. 470611→712590		0 265 208 002 ^H		
218 1.9 D		11.92-02.96	52/65		Fg.-Nr. 712591→		0 265 208 032 ^H		
218 i 16V		09.95-02.96	107		Fg.-Nr. 470611→712590		0 265 208 002 ^H		
					Fg.-Nr. 712591→		0 265 208 032 ^H		
					Fg.-Nr. 470611→712590		0 265 208 002 ^H		
					Fg.-Nr. 712591→		0 265 208 032 ^H		
		09.95-09.98	107		Fg.-Nr. →WD 267263		0 265 216 043 ^B		
					Fg.-Nr. →WD 267263		0 265 216 043 ^B		
		10.97-03.00	107		Fg.-Nr. WD 267264→YD 471564		0 265 216 520 ^B		
					Fg.-Nr. WD 267264→YD 471564		0 265 216 520 ^B		
		09.99-03.00	107		Fg.-Nr. YD 471565→		0 265 216 685 ^B		
					Fg.-Nr. YD 471565→		0 265 216 685 ^B		
218 i 16V Coupé		03.96-03.00	107				0 265 216 043 ^B		
220 GTi 16V		09.91-02.96	100/103/		Fg.-Nr. 470611→712590		0 265 208 002 ^H		
220 GTi/GSi			147						
220 i Turbo		11.92-02.96	100/103/		Fg.-Nr. 712591→		0 265 208 032 ^H		
220 i Turbo Coupé			147						
		03.96-06.96	100/103/				0 265 216 043 ^B		
			147						
220 SD		09.95-02.96	63/77		Fg.-Nr. 470611→712590		0 265 208 002 ^H		
220 SDi					Fg.-Nr. 712591→		0 265 208 032 ^H		
		09.95-09.98	63/77		Fg.-Nr. →WD 267263		0 265 216 043 ^B		
		10.97-03.00	63/77		Fg.-Nr. WD 267264→YD 471564		0 265 216 520 ^B		
		09.99-03.00	63/77		Fg.-Nr. YD 471565→		0 265 216 685 ^B		
211 i		10.97-03.00	44-45		Fg.-Nr. WD 267264→YD 471564		1 273 004 247 ^H		
		09.99-03.00	44-45		Fg.-Nr. YD 471565→		1 273 004 397 ^H		
214 Cabrio		10.92-02.96	66-70		Fg.-Nr. 712591→	TEI	2 267 000 709 ^H		
214 i		01.93-02.96	55		Fg.-Nr. 712591→	TEI	2 267 000 709 ^H		
		10.97-03.00	55		Fg.-Nr. WD 267264→YD 471564		1 273 004 247 ^H		
		09.99-03.00	55		Fg.-Nr. YD 471565→		1 273 004 397 ^H		
214 Si 16V Cabrio		03.96-03.96	76				1 267 000 826 ^H		
214 Si 16V, Si 16V Cabrio		10.92-02.96	76		Fg.-Nr. 712591→	TEI	2 267 000 709 ^H		
214 16V Coupé		10.97-03.00	76		Fg.-Nr. WD 267264→YD 471564		1 273 004 247 ^H		
		09.99-03.00	76		Fg.-Nr. YD 471565→		1 273 004 397 ^H		
216 GTi 16V, GTi 16V Cabrio, i 16V, i 16V Coupé		10.89-02.96	82-85/90-96				0 273 004 044 ^H		
216 i 16V Cabrio, i 16V Coupé		03.96-03.00	82				0 273 004 044 ^H		
216 16V		10.97-03.00	82		Fg.-Nr. WD 267264→YD 471564		1 273 004 247 ^H		
		09.99-03.00	82		Fg.-Nr. YD 471565→		1 273 004 397 ^H		
218 D Turbo, 1.9 D		10.92-02.96	52/65		Fg.-Nr. 712591→	TEI	2 267 000 709 ^H		
218 i 16V		09.95-02.96	107		Fg.-Nr. 712591→	TEI	2 267 000 709 ^H		
					Fg.-Nr. 712591→	TEI	2 267 000 709 ^H		
		10.97-03.00	107		Fg.-Nr. WD 267264→YD 471564		1 273 004 247 ^H		
					Fg.-Nr. WD 267264→YD 471564		1 273 004 247 ^H		
		09.99-03.00	107		Fg.-Nr. YD 471565→		1 273 004 397 ^H		
					Fg.-Nr. YD 471565→		1 273 004 397 ^H		
218 i 16V, i 16V Coupé		09.95-03.00	107				0 273 004 044 ^H		
220 GTi 16V		10.92-02.96	103		Fg.-Nr. 712591→	TEI	2 267 000 709 ^H		
220 GTi/GSi		10.92-02.96	100		Fg.-Nr. 712591→	TEI	2 267 000 709 ^H		
		10.92-06.96	100				0 273 004 044 ^H		



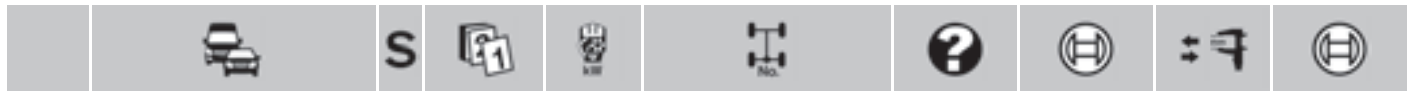



ROVER Serie 200

220 i Turbo	01.93-02.96	147	Fg.-Nr. 712591→	TEI	2 267 000 709 ^H	
220 i Turbo Coupé	01.93-06.96	147			0 273 004 044 ^H	
220 SD	09.95-02.96	63/77	Fg.-Nr. 712591→	TEI	2 267 000 709 ^H	
220 SDI	10.97-03.00	63/77	Fg.-Nr. WD 267264→YD 471564		1 273 004 247 ^H	
	09.99-03.00	63/77	Fg.-Nr. YD 471565→		1 273 004 397 ^H	









Serie 400



 414 Si 16V	05.95-03.00	76	Fg.-Nr. →AD 074464	JBH	0 986 481 027	23,81	
			Fg.-Nr. AD 074465→	JBH	0 986 480 889	23,8	
414 16V	ABO 04.90-04.95	66-70/76		LLE	0 986 480 676	22,2	
				JBH,RLE	0 986 480 622	22,2	
	ABS 04.90-04.95	66-70			0 986 480 670	22,2	
		01.93-02.96	76		0 986 480 670	22,2	
		05.95-02.96	76	Fg.-Nr. →AD 074464	JBH	0 986 481 027	23,81
			Fg.-Nr. 074465→	JBH,RLE	0 986 480 889	23,8	
416 GSi 16V	ABS 04.90-04.95	82-85			0 986 480 670	22,2	
		05.95-02.96	82-85	Fg.-Nr. →AD 074464	JBH	0 986 481 027	23,81
			Fg.-Nr. 074465→	JBH,RLE	0 986 480 889	23,8	
416 GSi 16V	ABO 04.90-04.95	82-85/		LLE	0 986 480 676	22,2	
416 GTi 16V		90-96		JBH,RLE	0 986 480 622	22,2	
416 GTi 16V	ABS 04.90-04.95	90-96			0 986 480 670	22,2	
		05.95-02.96	90-96	Fg.-Nr. →AD 074464	JBH	0 986 481 027	23,81
			Fg.-Nr. 074465→	JBH,RLE	0 986 480 889	23,8	
416 i 16V	ABS 05.95-10.99	83	Fg.-Nr. →AD 074464	JBH	0 986 481 027	23,81	
			Fg.-Nr. 074465→	JBH,RLE	0 986 480 889	23,8	
		05.95-03.00	82	Fg.-Nr. →AD 074464	JBH	0 986 481 027	23,81
			Fg.-Nr. 074465→	JBH,RLE	0 986 480 889	23,8	
418 D 1.9	ABS 11.92-04.95	49		LLE	0 986 480 671	22,2	
418 TD	ABS 11.92-04.95	65		LLE	0 986 480 671	22,2	
		05.95-02.96	65	Fg.-Nr. →AD 074464	JBH	0 986 481 027	23,81
			Fg.-Nr. 074465→	JBH,RLE	0 986 480 889	23,8	
420 i Turbo 16V, SD, SDI, 16V	ABS 05.95-03.00	63/77/100-103/147	Fg.-Nr. →AD 074464	JBH	0 986 481 027	23,81	
			Fg.-Nr. 074465→	JBH,RLE	0 986 480 889	23,8	

 414 Si 16V	05.95-03.00	76	Fg.-Nr. AD 074465→		0 986 485 134	
414 16V	ABO 05.95-02.96	76	Fg.-Nr. AD 074465→	GS	0 986 485 128	
	ABS 04.90-04.95	66-70			0 986 485 126	
		01.93-04.95	76		0 986 485 126	
		05.95-02.96	76	Fg.-Nr. AD 074465→	0 986 485 134	
416 GSi 16V	ABO 05.95-03.00	82-85/	Fg.-Nr. AD 074465→	GS	0 986 485 128	
416 GTi 16V		90-96				
416 i 16V	ABS 05.95-03.00	82-85/90-96	Fg.-Nr. AD 074465→		0 986 485 134	
418 D 1.9	ABS 09.91-04.95	49			0 986 485 126	
418 TD	ABO 05.95-02.96	65	Fg.-Nr. AD 074465→	GS	0 986 485 128	
	ABS 09.91-04.95	65			0 986 485 126	
		05.95-02.96	65	Fg.-Nr. AD 074465→	0 986 485 134	
420 i Turbo 16V, SD, SDI, 16V	ABO 05.95-03.00	63/77/100-103/147	Fg.-Nr. AD 074465→	GS	0 986 485 128	
420 i Turbo 16V	ABS 02.92-04.95	100-103/147			0 986 485 126	
420 16V		05.95-02.96	100-103/147	Fg.-Nr. AD 074465→	0 986 485 134	
420 SD, SDI, 16V	ABS 10.95-03.00	63/77/100	Fg.-Nr. AD 074465→		0 986 485 134	





















 414 Si 16V	05.95-03.00	76	Fg.-Nr. →AD 250028	GS	0 265 216 043 ^B	
414 Si 16V	01.93-03.00	76	Fg.-Nr. YD 471064→		0 265 216 685 ^B	
414 16V	05.95-03.00	76	Fg.-Nr. WD 250029→	GS	0 265 216 520 ^B	
			YD 471063			

		S								
414 16V	04.90-04.95	66-70	Fg.-Nr. →712590				0 265 208 002 ^H			
	01.93-04.95	76	Fg.-Nr. →AD 712590				0 265 208 002 ^H			
	01.93-02.96	76	Fg.-Nr. AD 712591→				0 265 208 032 ^H			
	05.95-02.96	76	Fg.-Nr. →AD 250028	GS			0 265 216 043 ^B			
416 GSi 16V	04.90-03.00	82-85/ 90-96	Fg.-Nr. YD 471064→	AG			0 265 216 685 ^B			
416 GTi 16V	05.95-03.00	82-85/ 90-96	Fg.-Nr. →AD 250028	AG			0 265 216 047 ^B			
				GS			0 265 216 043 ^B			
			Fg.-Nr. WD 250029→	AG			0 265 216 494 ^B			
			Fg.-Nr. WD 250029→	GS			0 265 216 520 ^B			
418 D 1.9	09.91-04.95	49	Fg.-Nr. →AD 712590				0 265 208 002 ^H			
	11.92-04.95	49	Fg.-Nr. AD 712591→				0 265 208 032 ^H			
418 TD	09.91-04.95	65	Fg.-Nr. →AD 712590				0 265 208 002 ^H			
	09.91-02.96	65	Fg.-Nr. YD 471064→				0 265 216 685 ^B			
	11.92-02.96	65	Fg.-Nr. AD 712591→				0 265 208 032 ^H			
	05.95-02.96	65	Fg.-Nr. →AD 250028	AG			0 265 216 047 ^B			
				GS			0 265 216 043 ^B			
			Fg.-Nr. WD 250029→	AG			0 265 216 494 ^B			
			Fg.-Nr. WD 250029→	GS			0 265 216 520 ^B			
420 i Turbo 16V	02.92-04.95	100-103/ 147	Fg.-Nr. →AD 712590				0 265 208 002 ^H			
	02.92-02.96	100-103/ 147	Fg.-Nr. YD 471064→				0 265 216 685 ^B			
	11.92-02.96	100-103/ 147	Fg.-Nr. AD 712591→				0 265 208 032 ^H			
	05.95-02.96	100-103/ 147	Fg.-Nr. →AD 250028	AG			0 265 216 047 ^B			
				GS			0 265 216 043 ^B			
			Fg.-Nr. WD 250029→	AG			0 265 216 494 ^B			
			Fg.-Nr. WD 250029→	GS			0 265 216 520 ^B			
420 SDI	10.95-03.00	63/77/100	Fg.-Nr. →AD 250028	AG			0 265 216 047 ^B			
				GS			0 265 216 043 ^B			
				Fg.-Nr. WD 250029→	AG			0 265 216 494 ^B		
				Fg.-Nr. WD 250029→	GS			0 265 216 520 ^B		
				Fg.-Nr. YD 471064→				0 265 216 685 ^B		
414 Si 16V	05.95-03.00	76	Fg.-Nr. YD 471064→				1 273 004 397 ^H			
	01.93-03.00	76	Fg.-Nr. WD 250029→YD 471063				1 273 004 247 ^H			
414 16V	10.92-04.95	66-70	Fg.-Nr. AD 712591→	TEI			2 267 000 709 ^H			
	01.93-04.95	76	Fg.-Nr. AD 712591→	TEI			2 267 000 709 ^H			
	01.93-02.96	76	Fg.-Nr. →AD 250028	GS			1 267 000 826 ^H			
							1 273 004 397 ^H			
	05.95-02.96	76	Fg.-Nr. YD 471064→	AG			1 273 004 238 ^H			
416 GSi 16V	04.90-03.00	82-85/ 90-96	Fg.-Nr. →AD 250028	GS			1 267 000 826 ^H			
			Fg.-Nr. WD 250029→YD 471063				1 273 004 247 ^H			
416 GTi 16V	05.95-03.00	82-85/ 90-96	Fg.-Nr. YD 471064→				1 273 004 397 ^H			
			Fg.-Nr. WD 250029→	AG			1 273 004 238 ^H			
418 D 1.9	10.92-04.95	49	Fg.-Nr. AD 712591→	TEI			2 267 000 709 ^H			
	09.91-02.96	65	Fg.-Nr. →AD 250028	GS			1 267 000 826 ^H			
418 TD	09.91-02.96	65	Fg.-Nr. WD 250029→YD 471063				1 273 004 247 ^H			
			Fg.-Nr. YD 471064→				1 273 004 397 ^H			
			Fg.-Nr. AD 712591→	TEI			2 267 000 709 ^H			
	05.95-02.96	65	Fg.-Nr. WD 250029→	AG			1 273 004 238 ^H			
420 i Turbo 16V	02.92-02.96	100-103/ 147	Fg.-Nr. →AD 250028	GS			1 267 000 826 ^H			
	10.92-04.95	100-103/ 147	Fg.-Nr. WD 250029→YD 471063				1 273 004 247 ^H			
			Fg.-Nr. YD 471064→				1 273 004 397 ^H			
420 16V	10.92-04.95	100-103/ 147	Fg.-Nr. AD 712591→	TEI			2 267 000 709 ^H			

**414** Si 16V**414** Si 16V, 16V**414** 16V**416** GSi 16V**416** GTi 16V**416** i 16V**418** D 1.9**418** TD**420** i Turbo 16V**420** 16V



















		S							
ROVER Serie 400									
	420 i Turbo 16V	05.95-02.96	100-103/147	Fg.-Nr. WD 250029→	AG		1273 004 238 ^H		
	420 16V								
	420 SD	10.95-03.00	63/77/100	Fg.-Nr. →AD 250028	GS		1267 000 826 ^H		
	420 SDI			Fg.-Nr. WD 250029→	AG		1273 004 238 ^H		
	420 16V			Fg.-Nr. WD 250029→YD 471063			1273 004 247 ^H		
				Fg.-Nr. YD 471064→			1273 004 397 ^H		
Serie 400 Coupé									
	418 GSi 16V	ABS	01.97-12.98	107	Fg.-Nr. →AD 074464	JBH	0986 481 027	23,81	
					Fg.-Nr. 074465→	JBH,RLE	0986 480 889	23,8	
	418 GSi 16V	ABO	01.97-12.98	107	Fg.-Nr. AD 074465→	GS	0986 485 128		
		ABS	01.97-12.98	107	Fg.-Nr. AD 074465→		0986 485 134		
	418 GSi 16V		01.97-12.98	107	Fg.-Nr. →AD 250028	AG	0265 216 047 ^B		
						GS	0265 216 043 ^B		
					Fg.-Nr. WD 250029→	AG	0265 216 494 ^B		
					Fg.-Nr. WD 250029→	GS	0265 216 520 ^B		
					YD 471063				
					Fg.-Nr. YD 471064→		0265 216 685 ^B		
	418 GSi 16V		01.97-12.98	107	Fg.-Nr. →AD 250028	GS	1267 000 826 ^H		
					Fg.-Nr. WD 250029→	AG	1273 004 238 ^H		
					Fg.-Nr. WD 250029→YD 471063		1273 004 247 ^H		
					Fg.-Nr. YD 471064→		1273 004 397 ^H		
Serie 400 Tourer									
	416 GSi 16V	ABO	04.90-04.95	82-85/90-96		LLE	0986 480 676	22,2	
	416 GTi 16V					JBH,RLE	0986 480 622	22,2	
		ABS	04.90-04.95	82-85/90-96			0986 480 670	22,2	
			05.95-02.96	82-85/90-96	Fg.-Nr. →AD 074464	JBH	0986 481 027	23,81	
					Fg.-Nr. 074465→	JBH,RLE	0986 480 889	23,8	
	416 i 16V	ABO	03.96-03.00	82		JBH	0986 480 873		
	418 D 1.9	ABS	11.92-04.95	49		LLE	0986 480 671	22,2	
	418 i 16V	ABO	03.96-12.98	107		JBH	0986 480 873		
	418 TD	ABS	02.96-03.00	65		LLE	0986 480 671	22,2	
	416 GSi 16V	ABO	05.95-02.96	82-85/90-96	Fg.-Nr. AD 074465→	GS	0986 485 128		
	416 GTi 16V	ABS	05.95-02.96	82-85/90-96	Fg.-Nr. AD 074465→		0986 485 134		
	418 D 1.9	ABS	09.91-04.95	49			0986 485 126		
	418 TD		02.96-03.00	65			0986 485 126		
	416 GSi 16V		04.90-02.96	82-85/90-96	Fg.-Nr. YD 471064→		0265 216 685 ^B		
	416 GTi 16V		05.95-02.96	82-85/90-96	Fg.-Nr. →AD 250028	AG	0265 216 047 ^B		
						GS	0265 216 043 ^B		
					Fg.-Nr. WD 250029→	AG	0265 216 494 ^B		
					Fg.-Nr. WD 250029→	GS	0265 216 520 ^B		
					YD 471063				
	416 i 16V		03.96-03.00	82			0265 216 043 ^B		
	418 D 1.9		09.91-04.95	49	Fg.-Nr. →AD 712590		0265 208 002 ^H		
			11.92-04.95	49	Fg.-Nr. AD 712591→		0265 208 032 ^H		
	418 i 16V		03.96-12.98	107			0265 216 043 ^B		
			10.97-12.98	107	Fg.-Nr. WD 267264→YD 471564		0265 216 520 ^B		
	418 TD		03.96-03.00	65			0265 216 043 ^B		



									
	416 GSi 16V	04.90-02.96	82-85/	Fg.-Nr. →AD 250028	GS	1 267 000 826 ^H			
	416 GTi 16V		90-96	Fg.-Nr. WD 250029→YD 471063		1 273 004 247 ^H			
				Fg.-Nr. YD 471064→		1 273 004 397 ^H			
		05.95-02.96	82-85/	Fg.-Nr. WD 250029→	AG	1 273 004 238 ^H			
	418 D 1.9	10.92-04.95	49	Fg.-Nr. AD 712591→	TEI	2 267 000 709 ^H			
	418 i 16V	03.96-12.98	107			0 273 004 044 ^H			
Serie 600									
									
	618 i 16V	ABO 03.96-06.99	85	Fg.-Nr. →AM 246796	LLE	0 986 480 957	23,8		
				Fg.-Nr. BM 246797→	JBH,RLE	0 986 480 889	23,8		
		ABS 03.96-06.99	85	Fg.-Nr. →AM 246796	RLE	0 986 480 948	25,4		
	620 i 16V	ABO 04.93-09.00	77/85/96/	Fg.-Nr. →AM 246796	LLE	0 986 480 957	23,8		
	620 i 16V Turbo		100/147	Fg.-Nr. BM 246797→	JBH,RLE	0 986 480 889	23,8		
	620 SDi	ABS 04.93-09.00	77/85/96/	Fg.-Nr. →AM 246796	RLE	0 986 480 948	25,4		
		100/147							
	623 i 16V	ABO 04.93-06.99	116	Fg.-Nr. →AM 246796	LLE	0 986 480 957	23,8		
				Fg.-Nr. BM 246797→	JBH,RLE	0 986 480 889	23,8		
		ABS 04.93-06.99	116	Fg.-Nr. →AM 246796	RLE	0 986 480 948	25,4		
	618 i 16V	ABO 03.96-06.99	85	Fg.-Nr. BM 246797→		0 986 485 134			
	620 i 16V	ABO 04.93-09.00	85/96/100/	Fg.-Nr. BM 246797→		0 986 485 134			
	620 i 16V Turbo		147						
	620 SDi	03.95-12.98	77	Fg.-Nr. BM 246797→		0 986 485 134			
	623 i 16V	ABO 04.93-06.99	116	Fg.-Nr. BM 246797→		0 986 485 134			
	618 i 16V	03.96-06.99	85			0 986 486 524	19		
	620 i 16V	04.93-09.00	85/96/100			0 986 486 524	19		
	623 i 16V	04.93-06.99	116			0 986 486 524	19		
	618 i 16V	03.96-06.99	85	Fg.-Nr. BM 246797→		0 265 216 049 ^H			
	620 i 16V Turbo	04.93-12.98	147	Fg.-Nr. →AM 246796		0 265 208 040 ^B			
				Fg.-Nr. BM 246797→		0 265 216 049 ^H			
	620 i 16V	04.93-09.00	77/85/96/	Fg.-Nr. BM 246797→		0 265 216 049 ^H			
	620 SDi		100						
623 i 16V	04.93-06.99	116	Fg.-Nr. BM 246797→		0 265 216 049 ^H				
	618 i 16V	03.96-06.99	85	Fg.-Nr. AM 144845→	RLE	1 267 000 831 ^H			
				AM 246796					
	620 i 16V	04.93-09.00	85/96/100	Fg.-Nr. AM 144845→	RLE	1 267 000 831 ^H			
			AM 246796						
623 i 16V	04.93-06.99	116	Fg.-Nr. AM 144845→	RLE	1 267 000 831 ^H				
			AM 246796						
Serie 800									
									
	820 i 16V	ABO 01.92-09.99	100-103/	Fg.-Nr. 266628→	RLE	0 986 480 956	23,8		
	820 i 16V Turbo		132-147						
	825 i, i Coupé	01.96-12.98	129		JBH,RLE	0 986 480 889	23,8		
	825 TD	ABO 10.91-12.98	87/88	Fg.-Nr. 266628→	RLE	0 986 480 956	23,8		
	827 i 24V, i 24V Coupé	ABO 01.92-01.96	124-130	Fg.-Nr. 266628→	RLE	0 986 480 956	23,8		
	820 i 16V	01.92-01.96	100-103/	Fg.-Nr. RS 100318→230966		0 265 208 040 ^B			
	820 i 16V Turbo		132-147						
		01.96-09.99	100-103/	Fg.-Nr. 230967→		0 265 216 043 ^B			
			132-147						
	825 i, i Coupé, TD	01.96-12.98	92/129	Fg.-Nr. 230967→		0 265 216 043 ^B			
825 TD	10.91-01.96	87/88	Fg.-Nr. RS 100318→230966		0 265 208 040 ^B				
	01.96-12.98	87/88	Fg.-Nr. 230967→		0 265 216 043 ^B				

		S							
ROVER Serie 800									
	827 i 24V	01.92-01.96	124-130	Fg.-Nr. RS 100318→230966		0 265 208 040 ^B			
	827 i 24V Coupé	01.96-01.96	124-130	Fg.-Nr. 230967→		0 265 216 043 ^B			
	820 i 16V	01.92-01.96	100-103/	Fg.-Nr. RS 100318→RS 230966		2 267 000 745 ^H			
	820 i 16V Turbo		132-147						
	825 TD	10.91-01.96	87/88	Fg.-Nr. RS 100318→RS 230966		2 267 000 745 ^H			
	827 i 24V, i 24V Coupé	01.92-01.96	124-130	Fg.-Nr. RS 100318→RS 230966		2 267 000 745 ^H			
25									
	1.1 i 16V	02.03-05.05	55	Fg.-Nr. →WD 267263		0 265 216 043 ^B			
				Fg.-Nr. WD 267264→YD 471564		0 265 216 520 ^B			
				Fg.-Nr. YD 471565→		0 265 216 685 ^B			
	1.4 i 16V	02.00-05.05	62/76	Fg.-Nr. →WD 267263		0 265 216 043 ^B			
				Fg.-Nr. WD 267264→YD 471564		0 265 216 520 ^B			
				Fg.-Nr. YD 471565→		0 265 216 685 ^B			
	1.6 i 16V	02.00-05.05	80	Fg.-Nr. →WD 267263		0 265 216 043 ^B			
				Fg.-Nr. WD 267264→YD 471564		0 265 216 520 ^B			
				Fg.-Nr. YD 471565→		0 265 216 685 ^B			
	1.8 i 16V	02.00-10.04	86/107	Fg.-Nr. →WD 267263		0 265 216 043 ^B			
				Fg.-Nr. WD 267264→YD 471564		0 265 216 520 ^B			
				Fg.-Nr. YD 471565→		0 265 216 685 ^B			
	2.0 iDT	02.00-05.05	74/83	Fg.-Nr. →WD 267263		0 265 216 043 ^B			
				Fg.-Nr. WD 267264→YD 471564		0 265 216 520 ^B			
				Fg.-Nr. YD 471565→		0 265 216 685 ^B			
	1.1 i 16V	02.03-05.05	55	Fg.-Nr. WD 267264→YD 471564		1 273 004 247 ^H			
				Fg.-Nr. YD 471565→		1 273 004 397 ^H			
	1.4 i 16V	02.00-05.05	62/76	Fg.-Nr. WD 267264→YD 471564		1 273 004 247 ^H			
				Fg.-Nr. YD 471565→		1 273 004 397 ^H			
	1.6 i 16V	02.00-05.05	80	Fg.-Nr. WD 267264→YD 471564		1 273 004 247 ^H			
				Fg.-Nr. YD 471565→		1 273 004 397 ^H			
	1.8 i 16V	02.00-10.04	86/107	Fg.-Nr. WD 267264→YD 471564		1 273 004 247 ^H			
				Fg.-Nr. YD 471565→		1 273 004 397 ^H			
	2.0 iDT	02.00-05.05	74/83	Fg.-Nr. WD 267264→YD 471564		1 273 004 247 ^H			
				Fg.-Nr. YD 471565→		1 273 004 397 ^H			
45									
	1.4 16V	02.00-05.05	76	Fg.-Nr. →AD 074464	JBH	0 986 481 027	23,81		
				Fg.-Nr. AD 074465→	JBH	0 986 480 889	23,8		
	1.6 16V	02.00-05.05	80	Fg.-Nr. →AD 074464	JBH	0 986 481 027	23,81		
				Fg.-Nr. AD 074465→	JBH	0 986 480 889	23,8		
	1.8 16V	02.00-05.05	86	Fg.-Nr. →AD 074464	JBH	0 986 481 027	23,81		
				Fg.-Nr. AD 074465→	JBH	0 986 480 889	23,8		
	2.0 iDT	02.00-05.05	74/83	Fg.-Nr. AD 074465→	JBH	0 986 480 889	23,8		
	2.0 V6	02.00-05.05	110	Fg.-Nr. →AD 074464	JBH	0 986 481 027	23,81		
				Fg.-Nr. AD 074465→	JBH	0 986 480 889	23,8		
				YD 471063					
	1.4 16V	02.00-05.05	76	Fg.-Nr. AD 074465→		0 986 485 134			
	1.6 16V	02.00-05.05	80	Fg.-Nr. AD 074465→		0 986 485 134			
	1.8 16V	02.00-05.05	86	Fg.-Nr. AD 074465→		0 986 485 134			
	2.0 iDT	02.00-05.05	74/83			0 986 485 134			
	1.4 16V	02.00-05.05	76	Fg.-Nr. →AD 250028	GS	0 265 216 043 ^B			
				Fg.-Nr. WD 250029→	GS	0 265 216 520 ^B			
				YD 471063					
				Fg.-Nr. YD 471064→		0 265 216 685 ^B			



		S							
1.6 16V		02.00-05.05	80	Fg.-Nr. →AD 250028	AG	0 265 216 047 ^B			
					GS	0 265 216 043 ^B			
				Fg.-Nr. WD 250029→	AG	0 265 216 494 ^B			
				Fg.-Nr. WD 250029→	GS	0 265 216 520 ^B			
				YD 471063					
				Fg.-Nr. YD 471064→		0 265 216 685 ^B			
1.8 16V		02.00-05.05	86	Fg.-Nr. →AD 250028	GS	0 265 216 043 ^B			
				Fg.-Nr. WD 250029→	GS	0 265 216 520 ^B			
				YD 471063					
				Fg.-Nr. YD 471064→		0 265 216 685 ^B			
2.0 iDT		02.00-05.05	74/83/110	Fg.-Nr. →AD 250028	GS	0 265 216 043 ^B			
2.0 V6				Fg.-Nr. WD 250029→	GS	0 265 216 520 ^B			
				YD 471063					
				Fg.-Nr. YD 471064→		0 265 216 685 ^B			
 1.4 16V		02.00-05.05	76	Fg.-Nr. WD 250029→	GS	1 273 004 247 ^H			
				YD 471063					
				Fg.-Nr. YD 471064→		1 273 004 397 ^H			
1.6 16V		02.00-05.05	80	Fg.-Nr. WD 250029→	GS	1 273 004 247 ^H			
				YD 471063					
				Fg.-Nr. YD 471064→		1 273 004 397 ^H			
1.8 16V		02.00-05.05	86	Fg.-Nr. WD 250029→	GS	1 273 004 247 ^H			
				YD 471063					
				Fg.-Nr. YD 471064→		1 273 004 397 ^H			
2.0 iDT		02.00-05.05	74/83/110	Fg.-Nr. WD 250029→	GS	1 273 004 247 ^H			
2.0 V6				YD 471063					
				Fg.-Nr. YD 471064→		1 273 004 397 ^H			
75									
									
 2.0 CDT, CDTi		01.99-05.05	85/96			0 265 224 010 ^F			
2.0 i 24V		01.99-05.05	110			0 265 224 005 ^F			
2.5 i 24V		01.99-05.05	130			0 265 224 005 ^F			
4.6 i Power		10.03-05.05	191			0 265 223 006 ^F			
 2.0 i 24V		01.99-05.05	110			0 265 108 045 ^H			
2.5 i 24V		01.99-05.05	130			0 265 108 045 ^H			
75 Tourer									
									
 2.0 CDT, CDTi		01.01-05.05	85/96			0 265 224 010 ^F			
2.0 i 24V		01.01-05.05	110			0 265 224 005 ^F			
2.5 i 24V		01.01-05.05	130			0 265 224 005 ^F			
4.6 i Power		10.03-05.05	191			0 265 223 006 ^F			
 2.0 i 24V		01.01-05.05	110			0 265 108 045 ^H			
2.5 i 24V		01.01-05.05	130			0 265 108 045 ^H			
100 Metro									
									
 1.1, i		05.90-12.98	44			0 986 480 941	20,64		
1.4 D, GTi 16V, i, i 16V		09.90-10.98	38/55/75/76			0 986 480 941	20,64		
1.5 D		12.94-12.98	42			0 986 480 941	20,64		
 1.1, i		05.90-12.98	44	Fg.-Nr. XP 100001→		0 986 485 089			
1.4 D, GTi 16V, i, i 16V		09.90-10.98	38/55/75/76	Fg.-Nr. XP 100001→		0 986 485 089			
1.5 D		12.94-12.98	42	Fg.-Nr. XP 100001→		0 986 485 089			



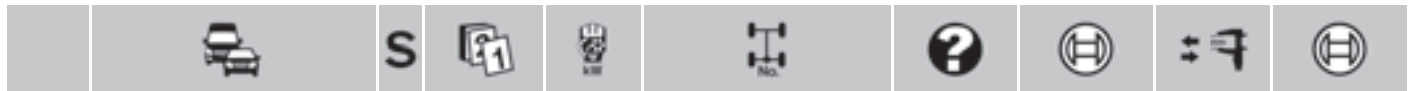

◀ ROVER 100 Metro

	1.1, i	05.90-12.98	44	Fg.-Nr. →AD 507467, →AD 748736GS	0986	482 012	
	1.4D, GTi 16V, i, i 16V	09.90-10.98	38/55/75/76	Fg.-Nr. →AD 507467, →AD 748736GS	0986	482 012	
	1.5D	12.94-12.98	42	Fg.-Nr. →AD 507467, →AD 748736GS	0986	482 012	

100 Metro Cabrio



	1.1 i	09.90-12.97	44		0986	480 941	20,64
	1.4 i, i 16V	09.90-10.98	55/75		0986	480 941	20,64

	1.1 i	09.90-12.97	44	Fg.-Nr. XP 100001→	0986	485 089	
	1.4 i, i 16V	09.90-10.98	55/75	Fg.-Nr. XP 100001→	0986	485 089	

	1.1 i	09.90-12.97	44	Fg.-Nr. →AD 507467, →AD 748736GS	0986	482 012	
	1.4 i, i 16V	09.90-10.98	55/75	Fg.-Nr. →AD 507467, →AD 748736GS	0986	482 012	

SAAB (SAAB AUTOMOBILE AB)

9-3 Cabriolet [9400]



	2.0 i 16V, i 16V Turbo, T	03.98-08.00	96/110/113/136/147/151	JBH,LLE	0986	480 758	23,8
	2.3 i 16V, T	03.98-08.00	110/165-169	JBH,LLE	0986	480 758	23,8

	2.0 i 16V, i 16V Turbo, T	03.98-08.03	96/110/113/136/147/151		0986	486 585	34
	2.3 i 16V, T	03.98-08.03	110/165-169		0986	486 585	34

	2.0 i 16V Turbo	03.98-08.03	136		0265	216 472^B	
		09.98-08.00	147		0265	216 472^B	
		09.99-08.03	136		0265	220 626^F	
	2.0 i 16V, i 16V Turbo, T	03.98-07.03	96/110/113		0265	216 472^B	
		2.0 T	10.99-07.03	151		0265	216 472^B
	2.3 i 16V	03.98-08.00	110		0265	216 472^B	
		2.3 T	10.99-08.03	165-169		0265	220 626^F

9-3 Cabriolet [9440]



	1.8 T, T BioPower	08.03-08.11	110/129	RLE	F 026	A06 914	
	1.9 TiD, TTiD	01.06-08.11	110/118/132	RLE	F 026	A06 914	
	2.0 T, T BioPower, T 4x4	08.03-08.11	120/129-131/145/147/154	RLE	F 026	A06 914	





















	1.8 T, T BioPower	08.03-06.12	110/129	LLE	0986	486 110	15,87
	1.9 TiD, TTiD	01.06-06.12	110/118/132	LLE	0986	486 110	15,87
	2.0 T, T BioPower, T 4x4	08.03-06.12	120/129-131/145/147/154	LLE	0986	486 110	15,87
	2.8 T	09.05-06.12	184-188/203-206	LLE	0986	486 110	15,87

	1.8 T, T BioPower	08.03-06.12	110/129	MG6	0986	486 579	34
	1.9 TiD, TTiD	01.06-06.12	110/118/132	MG6	0986	486 579	34
	2.0 T, T BioPower, T 4x4	08.03-06.12	120/129-131/145/147/154	MG6	0986	486 579	34
	2.8 T	09.05-06.12	184-188/203-206	MG6	0986	486 579	34











9-3 Coupé [9400]



	2.0 i 16V	03.98-08.00	96/136/147/151	JBH,LLE	0986	480 758	23,8
	2.0 i 16V Turbo						

		S							
	2.0i 16V, i16V Turbo	03.98-08.03	96/136/147/151				0 986 486 585	34	
	2.2 16V D Turbo	11.00-09.02	92	Fg.-Nr. →12020000			0 986 486 585	34	
	2.3i 16V Turbo	09.99-08.00	165				0 986 486 585	34	
	2.0i 16V	03.98-08.00	96				0 265 216 472^B		
	2.0i 16V Turbo	03.98-08.03	136				0 265 216 472^B		
		09.98-08.02	147/151				0 265 216 472^B		
		09.99-08.03	136				0 265 220 626^F		
	2.2 16V D Turbo	11.00-09.02	92				0 265 216 472^B		
	2.3i 16V Turbo	09.99-08.00	165				0 265 216 472^B		
							0 265 220 626^F		
9-3 Kombi [9440]									
									
	1.8i , T, T BioPower	03.05-08.11	90/110/129		RLE		F 026 A06 914		
	1.9 TiD, TTiD	03.05-08.11	88/96/110/118/132		RLE		F 026 A06 914		
	2.0 T, T BioPower, T BioPower XWD, T XWD	03.05-08.11	110/120/129/ 145-177		RLE		F 026 A06 914		
	1.8i , T, T BioPower	03.05-06.12	90/110/129		LLE		0 986 486 110	15,87	
	1.9 TiD, TTiD	03.05-06.12	88/96/110/118/132		LLE		0 986 486 110	15,87	
	2.0 T, T BioPower, T BioPower XWD, T XWD	03.05-06.12	110/120/129/ 145-177		LLE		0 986 486 110	15,87	
	2.8 T, T XWD	03.05-06.12	184-188/202/206		LLE		0 986 486 110	15,87	
	1.8i	03.05-12.09	90				0 986 486 588	31	
	1.8 T, T BioPower	05.05-06.12	110/129		MG6		0 986 486 579	34	
	1.9 TiD, TTiD	03.05-06.12	88/96/110/118/132		MG6		0 986 486 579	34	
	2.0 T, T BioPower, T BioPower XWD, T XWD	03.05-06.12	110/120/129/ 145-177		MG6		0 986 486 579	34	
	2.8 T, T XWD	03.05-06.12	184-188/ 202/206		MG6		0 986 486 579	34	
9-3 [9400]									
									
	2.0i 16V, i16V Turbo	03.98-08.00	96/110/113/136/147/151		JBH,LLE		0 986 480 758	23,8	
	2.2 16V D Turbo	03.98-08.00	85		JBH,LLE		0 986 480 758	23,8	
	2.3i 16V, i16V Turbo	03.98-08.00	110/125		JBH,LLE		0 986 480 758	23,8	
	2.0i 16V, i16V Turbo	03.98-08.02	96/110/113/136/147/151				0 986 486 585	34	
	2.2 16V D Turbo	03.98-09.02	85/92	Fg.-Nr. →12020000			0 986 486 585	34	
	2.3i 16V, i16V Turbo	03.98-08.02	110/125/169				0 986 486 585	34	
	2.0i 16V, i16V Turbo	03.98-08.02	96/110/113/136/147/151				0 265 216 472^B		
	2.2 16V D Turbo	03.98-09.02	85/92				0 265 216 472^B		
	2.3i 16V	03.98-08.00	110				0 265 216 472^B		
	2.3i 16V Turbo	09.98-08.02	125/169				0 265 216 472^B		
							0 265 220 626^F		
9-3 [9440]									
									
	1.8i , T, T BioPower	09.02-02.11	90/110/129		RLE		F 026 A06 914		
	1.9 TiD, TTiD	09.04-08.11	88/96/110/118/132		RLE		F 026 A06 914		
	2.0 T, T BioPower, T BioPower XWD, T Sport, T XWD	09.02-08.11	120/129/145-147/ 154-177		RLE		F 026 A06 914		
	1.8i , T, T BioPower	09.02-02.11	90/110/129		LLE		0 986 486 110	15,87	
	1.9 TiD, TTiD	09.04-06.12	88/96/110/118/132		LLE		0 986 486 110	15,87	

		S							
	◀ SAAB 9-3 [9440]								
	2.0 T, T BioPower, T BioPower XWD, T Sport, T XWD	09.02-06.12	120/129/145-147/154-177		LLE	0986 486 110	15,87		
	2.2 TiD	10.02-08.04	95		LLE	0986 486 110	15,87		
	2.8 T, T XWD	09.05-06.12	184-188/203/206		LLE	0986 486 110	15,87		
	1.8 i	09.04-09.10	90			0986 486 588	31		
	1.8 T, T BioPower	09.02-02.11	110/129		MG6	0986 486 579	34		
	1.9 TiD, TTiD	09.04-06.12	88/96/110/118/132		MG6	0986 486 579	34		
	2.0 T, T BioPower, T BioPower XWD, T Sport, T XWD	09.02-06.12	120/129/145-147/154-177		MG6	0986 486 579	34		
	2.2 TiD	10.02-08.04	95		MG6	0986 486 579	34		
	2.8 T, T XWD	09.05-06.12	184-188/203/206		MG6	0986 486 579	34		
9-3X [9440]									
	1.9 TTiD	03.10-06.12	132		RLE	F 026 A06 914			
	2.0 T BioPower XWD, T XWD	03.10-08.11	120/154		RLE	F 026 A06 914			
	1.9 TTiD	03.10-06.12	132		LLE	0986 486 110	15,87		
	2.0 T BioPower XWD, T XWD	03.10-06.12	120/154		LLE	0986 486 110	15,87		
	1.9 TTiD	03.10-06.12	132		MG6	0986 486 579	34		
	2.0 T BioPower XWD, T XWD	03.10-06.12	120/154		MG6	0986 486 579	34		
9-5 Kombi [9600]									
	1.9 TiD	01.06-02.10	110		JBH,LLE	0986 480 993	25,4		
	2.0 t, T	06.98-07.09	110/136/140		JBH,LLE	0986 480 944	25,4		
	2.2 TiD	03.02-08.05	88		JBH,LLE	0986 480 993	25,4		
	2.3 t	06.99-08.00	125		JBH,LLE	0986 480 944	25,4		
		09.00-08.01	136		JBH,LLE	0986 480 944	25,4		
		09.01-08.05	136		JBH,LLE	0986 480 993	25,4		
	2.3 T	09.03-08.05	162		JBH,LLE	0986 480 993	25,4		
	2.3 Turbo	05.99-09.01	169		JBH,LLE	0986 480 944	25,4		
		09.01-08.05	184/224		JBH,LLE	0986 480 993	25,4		
	3.0 t	06.97-08.01	147		JBH,LLE	0986 480 944	25,4		
		09.01-08.03	147		JBH,LLE	0986 480 993	25,4		
	3.0 TiD	09.01-08.05	130		JBH,LLE	0986 480 993	25,4		
	2.0 t	06.98-08.04	110			0986 486 585	34		
	2.0 T BioPower	01.06-02.10	110			0986 486 586	34		
	2.0 t, T	09.99-07.01	136/140			0986 486 585	34		
	2.0 Turbo	09.06-02.10	132			0986 486 586	34		
	2.2 TiD	03.02-08.05	88			0986 486 585	34		
	2.3 t	06.99-08.00	125			0986 486 585	34		
		09.00-08.04	136			0986 486 585	34		
	2.3 T	09.03-02.10	162	Get.-Nr. C03505→		0986 486 586	34		
				Get.-Nr. S63283→, →C030504		0986 486 585	34		
	2.3 T BioPower	01.07-02.10	136			0986 486 586	34		
	2.3 T, Turbo	01.06-02.10	188/191			0986 486 586	34		
	2.3 Turbo	05.99-02.10	169/184			0986 486 585	34		
		06.03-08.05	224	Get.-Nr. C03505→		0986 486 586	34		
				Get.-Nr. S63283→, →C030504		0986 486 585	34		
		11.06-02.10	152			0986 486 586	34		
	3.0 t	06.97-08.03	147			0986 486 585	34		
	3.0 TiD	09.01-08.05	130	Get.-Nr. →C03504		0986 486 585	34		
				Get.-Nr. C03505→		0986 486 586	34		

		S							
	1.9 TiD	01.06-02.10	110				0 265 234 431 ^T		
		01.07-02.10	129				0 265 220 626 ^F		
							0 265 234 431 ^T		
	2.0 t	06.98-08.99	110				0 265 220 521 ^F		
		06.98-08.04	110				0 265 202 521 ^T		
		06.98-07.09	110				0 265 216 472 ^B		
		09.99-08.00	140				0 265 202 521 ^T		
							0 265 216 472 ^B		
							0 265 220 626 ^F		
		09.99-07.09	110				0 265 220 626 ^F		
		09.04-08.05	110				0 265 234 149 ^T		
		09.05-07.09	110				0 265 234 431 ^T		
		2.0 T	07.00-07.01	136				0 265 220 626 ^F	
2.0 T BioPower	01.06-02.10	110				0 265 220 626 ^F			
						0 265 234 431 ^T			
2.0 Turbo	09.06-02.10	132				0 265 220 626 ^F			
						0 265 234 431 ^T			
2.2 TiD	03.02-08.05	88				0 265 202 521 ^T			
						0 265 216 472 ^B			
						0 265 220 626 ^F			
2.3 t	06.99-08.99	125				0 265 220 521 ^F			
						0 265 216 472 ^B			
						0 265 220 626 ^F			
						0 265 216 472 ^B			
						0 265 220 626 ^F			
2.3 T	09.03-08.04	162				0 265 202 521 ^T			
						0 265 216 472 ^B			
	09.03-02.10	162				0 265 220 626 ^F			
						0 265 234 149 ^T			
	09.04-08.05	162				0 265 234 431 ^T			
						0 265 234 431 ^T			
	2.3 T BioPower	01.07-02.10	136			0 265 234 431 ^T			
	2.3 T, Turbo	01.06-02.10	188/191			0 265 234 431 ^T			
	2.3 Turbo	05.99-08.99	169				0 265 220 521 ^F		
							0 265 216 472 ^B		
						0 265 220 626 ^F			
09.99-09.01		169				0 265 220 626 ^F			
						0 265 220 557 ^J			
10.99-09.01		169				0 265 220 521 ^T			
						0 265 202 521 ^T			
09.01-08.04		184				0 265 216 472 ^B			
						0 265 216 472 ^B			
09.01-02.10		184				0 265 220 626 ^F			
						0 265 220 626 ^F			
06.03-08.04		224				0 265 202 521 ^T			
						0 265 220 626 ^F			
					0 265 234 149 ^T				
					0 265 234 149 ^T				
					0 265 234 431 ^T				
09.05-02.10	184				0 265 234 431 ^T				
					0 265 234 431 ^T				
3.0 t	11.06-02.10	152				0 265 234 431 ^T			
						0 265 220 521 ^F			
						0 265 220 626 ^F			
3.0 t	06.97-08.99	147				0 265 220 626 ^F			
						0 265 220 626 ^F			
						0 265 202 521 ^T			
3.0 TiD	09.01-08.05	130				0 265 202 521 ^T			
						0 265 216 472 ^B			
						0 265 220 626 ^F			
	1.9 TiD	01.06-02.10	110/129			0 265 005 303			
	2.0 T BioPower, Turbo	01.06-02.10	110/132			0 265 005 303			
	2.2 TiD	03.02-08.05	88			0 265 005 303			
	2.3 t, T, T BioPower, Turbo	05.99-02.10	125/136/152/162/169/184/188/191/224			0 265 005 303			
	3.0 TiD	09.01-08.05	130			0 265 005 303			

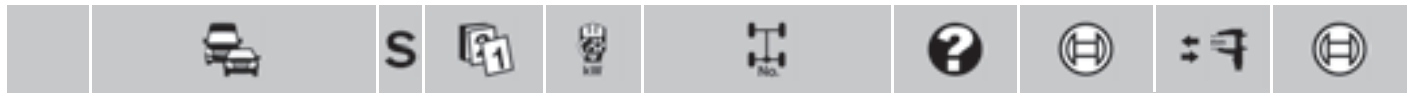

SAAB













9-5 [9600]



	1.9 TiD	09.05-02.10	110		JBH, LLE	0986 480 993	25,4
	2.0	07.00-08.01	136		JBH, LLE	0986 480 944	25,4
		09.01-08.05	136		JBH, LLE	0986 480 993	25,4
	2.0 t	06.97-08.09	110		JBH, LLE	0986 480 944	25,4
		09.99-08.00	140		JBH, LLE	0986 480 944	25,4
	2.0 T BioPower	01.05-08.05	110		JBH, LLE	0986 480 993	25,4
	2.2 TiD	03.02-08.05	88		JBH, LLE	0986 480 993	25,4
	2.3	09.99-08.01	172-187		JBH, LLE	0986 480 944	25,4
		09.01-08.05	172-187		JBH, LLE	0986 480 993	25,4
	2.3 t	06.97-08.00	125		JBH, LLE	0986 480 944	25,4
		09.00-08.01	136		JBH, LLE	0986 480 944	25,4
		09.01-08.05	136		JBH, LLE	0986 480 993	25,4
	2.3 T	09.03-08.05	162		JBH, LLE	0986 480 993	25,4
	2.3 Turbo	05.99-09.01	169		JBH, LLE	0986 480 944	25,4
		09.01-08.05	184		JBH, LLE	0986 480 993	25,4
3.0 t	06.97-08.01	147		JBH, LLE	0986 480 944	25,4	
	09.01-08.03	147		JBH, LLE	0986 480 993	25,4	
3.0 TiD	09.01-08.05	130		JBH, LLE	0986 480 993	25,4	

	2.0	07.00-02.10	136	Get.-Nr. C03505→	0986 486 586	34
				Get.-Nr. S63283→, →C030504	0986 486 585	34
	2.0 t	06.97-08.04	110		0986 486 585	34
				09.99-08.00	140	
	2.0 T BioPower	01.05-02.10	110		0986 486 586	34
	2.0 T BioPower, Turbo	09.05-02.10	132		0986 486 586	34
	2.2 TiD	03.02-08.05	88		0986 486 585	34
	2.3	09.99-08.05	172-187	Get.-Nr. →C03504, S63283→	0986 486 585	34
				Get.-Nr. C03505→	0986 486 586	34
	2.3 t	06.97-08.00	125		0986 486 585	34
				09.00-08.04	136	
	2.3 T	09.03-02.10	162	Get.-Nr. C03505→	0986 486 586	34
				Get.-Nr. S63283→, →C030504	0986 486 585	34
	2.3 T BioPower	01.07-02.10	136		0986 486 586	34
	2.3 T, Turbo	11.05-02.10	188/191		0986 486 586	34
	2.3 Turbo	05.99-09.01	169		0986 486 585	34
				09.01-02.10	184	
	2.3 Turbo BioPower	11.06-02.10	152		0986 486 586	34
				04.08-02.10	134	
	3.0 t	06.97-08.03	147		0986 486 585	34
	3.0 TiD	09.01-08.05	130	Get.-Nr. →C03504	0986 486 585	34
				Get.-Nr. C03505→	0986 486 586	34

	1.9 TiD	09.05-02.10	110		0 265 234 431 ^T
	2.0	07.00-08.01	136		0 265 220 626 ^F
		09.01-08.04	136		0 265 202 521 ^T
		09.04-08.05	136		0 265 234 149 ^T
		09.05-02.10	136		0 265 234 431 ^T
		09.05-02.10	136		0 265 234 431 ^T
	2.0 t	06.97-08.99	110		0 265 220 521 ^F
		06.97-08.04	110		0 265 202 521 ^T
		06.97-08.09	110		0 265 216 472 ^B
					0 265 216 472 ^B
		09.99-08.00	140		0 265 202 521 ^T
					0 265 216 472 ^B
		09.99-08.09	110		0 265 220 626 ^F
	2.0 T BioPower	01.05-02.10	110		0 265 220 626 ^F
	2.0 T BioPower	09.05-02.10	132		0 265 220 626 ^F
2.0 Turbo				0 265 234 431 ^T	
2.0 t	09.04-08.05	110		0 265 234 149 ^T	
2.0 T BioPower	09.05-02.10	110		0 265 234 431 ^T	

		S							
2.2 TiD			03.02-08.05	88			0 265 202 521 ^T		
							0 265 216 472 ^B		
							0 265 220 626 ^F		
2.3			09.99-08.01	172-187			0 265 216 472 ^B		
							0 265 220 626 ^F		
			09.01-08.04	172-187			0 265 202 521 ^T		
			09.04-08.05	172-187			0 265 234 149 ^T		
2.3 t			06.97-08.99	125			0 265 220 521 ^F		
			06.97-08.00	125			0 265 216 472 ^B		
			09.99-08.00	125			0 265 220 626 ^F		
			09.00-02.10	136			0 265 216 472 ^B		
							0 265 220 626 ^F		
2.3 T			09.03-08.04	162			0 265 202 521 ^T		
			09.03-02.10	162			0 265 216 472 ^B		
							0 265 220 626 ^F		
			09.04-08.05	162			0 265 234 149 ^T		
			09.05-02.10	162			0 265 234 431 ^T		
			11.05-02.10	191			0 265 220 626 ^F		
							0 265 234 431 ^T		
2.3 T BioPower			01.07-02.10	136			0 265 220 626 ^F		
							0 265 234 431 ^T		
2.3 Turbo			05.99-08.99	169			0 265 220 521 ^F		
			05.99-09.01	169			0 265 216 472 ^B		
			09.99-09.01	169			0 265 220 626 ^F		
			10.99-09.01	169			0 265 220 557 ^J		
			09.01-08.04	184			0 265 202 521 ^T		
			09.01-02.10	184			0 265 216 472 ^B		
							0 265 220 626 ^F		
			09.04-08.05	184			0 265 234 149 ^T		
			09.05-02.10	184			0 265 234 431 ^T		
			04.08-02.10	188			0 265 234 431 ^T		
2.3 Turbo BioPower			11.06-02.10	152			0 265 234 431 ^T		
			04.08-02.10	134			0 265 220 626 ^F		
							0 265 234 431 ^T		
3.0 t			06.97-08.99	147			0 265 220 521 ^F		
			09.99-08.01	147			0 265 220 626 ^F		
			09.01-08.03	147			0 265 202 521 ^T		
3.0 TiD			09.01-08.05	130			0 265 202 521 ^T		
							0 265 216 472 ^B		
							0 265 220 626 ^F		
 1.9 TiD			09.05-02.10	110			0 265 005 303		
2.0 T BioPower, Turbo			01.05-02.10	110/132			0 265 005 303		
2.2 TiD			03.02-08.05	88			0 265 005 303		
2.3, t, T, T BioPower, Turbo, Turbo BioPower			06.97-02.10	125/134/136/152/162/169/172-187/188/191			0 265 005 303		
3.0 TiD			09.01-08.05	130			0 265 005 303		
900 II									
									
 2.0 i, i Turbo			09.93-08.98	96/98/136		JBH	0 986 480 758	23,8	
2.3 i			09.93-08.98	110		JBH	0 986 480 758	23,8	
2.5 i			09.93-10.98	125		JBH, LLE	0 986 480 758	23,8	
 2.0 i			09.93-08.95	96/98/136			0 265 208 311 ^H		
2.0 i Turbo			09.95-08.96	96/98/136			0 265 216 422 ^H		
			09.96-08.97	96/98/136		EFV	0 265 216 470 ^H		
			09.97-08.98	96/98/136			0 265 216 472 ^B		
2.3 i			09.93-08.95	110			0 265 208 311 ^H		
			09.95-08.96	110			0 265 216 422 ^H		
			09.96-08.97	110		EFV	0 265 216 470 ^H		
			09.97-08.98	110			0 265 216 472 ^B		

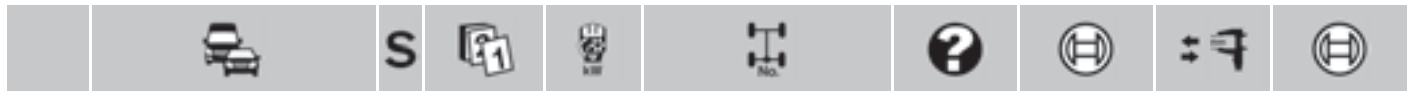

	SAAB 900 II					
	2.5 i	09.93-08.95	125			0 265 208 311 ^H
		09.95-08.96	125			0 265 216 422 ^H
		09.96-08.97	125	EFV		0 265 216 470 ^H
		09.97-10.98	125			0 265 216 472 ^B

900 II Cabriolet

	2.0 i, i Turbo	03.94-08.98	96/98/136	JBH		0 986 480 758	23,8
	2.3 i	03.94-08.98	110	JBH		0 986 480 758	23,8
	2.5 i	03.94-10.98	125	JBH,LLE		0 986 480 758	23,8

	2.0 i	03.94-08.95	96/98/136			0 265 208 311 ^H	
	2.0 i Turbo	09.95-08.96	96/98/136			0 265 216 422 ^H	
		09.96-08.97	96/98/136	EFV		0 265 216 470 ^H	
		09.97-08.98	96/98/136			0 265 216 472 ^B	
	2.3 i	03.94-08.95	110			0 265 208 311 ^H	
		09.95-08.96	110			0 265 216 422 ^H	
		09.96-08.97	110	EFV		0 265 216 470 ^H	
		09.97-08.98	110			0 265 216 472 ^B	
	2.5 i	03.94-08.95	125			0 265 208 311 ^H	
		09.95-08.96	125			0 265 216 422 ^H	
		09.96-08.97	125	EFV		0 265 216 470 ^H	
		09.97-10.98	125			0 265 216 472 ^B	

900 II Coupé

	2.0 i, i Turbo	03.94-08.98	96/98/136	JBH		0 986 480 758	23,8
	2.3 i	03.94-08.98	110	JBH		0 986 480 758	23,8
	2.5 i	03.94-10.98	125	JBH,LLE		0 986 480 758	23,8

	2.0 i	03.94-08.95	96/98/136			0 265 208 311 ^H	
	2.0 i Turbo	09.95-08.96	96/98/136			0 265 216 422 ^H	
		09.96-08.97	96/98/136	EFV		0 265 216 470 ^H	
		09.97-08.98	96/98/136			0 265 216 472 ^B	
	2.3 i	03.94-08.95	110			0 265 208 311 ^H	
		09.95-08.96	110			0 265 216 422 ^H	
		09.96-08.97	110	EFV		0 265 216 470 ^H	
		09.97-08.98	110			0 265 216 472 ^B	
	2.5 i	03.94-08.95	125			0 265 208 311 ^H	
		09.95-08.96	125			0 265 216 422 ^H	
		09.96-08.97	125	EFV		0 265 216 470 ^H	
		09.97-10.98	125			0 265 216 472 ^B	

SANTANA



















Land Rover

	88 Normal	01.84-12.94	51			0 204 123 247	23,8
--	-----------	-------------	----	--	--	---------------	------











SEAT

Alhambra [7V8]

	1.8 T	ABS	05.98-02.00	110	JBH	0 986 481 047	
--	-------	-----	-------------	-----	-----	---------------	--

		S							
1.9 TDI		09.97-02.00	81			JBH	0 986 481 047		
	ABO	03.96-07.96	66			JBH	0 986 480 930	23,81	
		07.96-08.97	66/81	Fg.-Nr. →7M..W..507 041		JBH	0 986 480 930	23,81	
	ABS	03.96-07.96	66			JBH	0 986 480 933	23,81	
		07.96-08.97	66/81	Fg.-Nr. →7M..W..507 041		JBH	0 986 480 933	23,81	
		09.97-02.00	66/81	Fg.-Nr. 7M..W..507 042→		JBH	0 986 481 047		
2.0	ABO	03.96-08.97	85	Fg.-Nr. →7M..W..507 041		JBH	0 986 480 930	23,81	
	ABS	03.96-08.97	85	Fg.-Nr. →7M..W..507 041		JBH	0 986 480 933	23,81	
		09.97-02.00	85	Fg.-Nr. 7M..W..507 042→		JBH	0 986 481 047		
	1.8 T	05.98-02.00	110				0 986 486 050	19,05	
	1.9 TDI	03.96-02.00	66/81				0 986 486 050	19,05	
	2.0	03.96-02.00	85				0 986 486 050	19,05	
Alhambra [7V9]									
									
	1.8 T	MFD	06.00-10.02	110	Fg.-Nr. →7M..3..515799	JBH	0 986 480 819		
		OFD	06.00-03.10	110		JBH,RLE	0 986 481 047		
	1.9 TDI	OFD	11.02-11.08	96		JBH,RLE	0 986 481 047		
			06.05-05.07	110		JBH,RLE	0 986 481 047		
	1.9 TDI, TDI 4Motion	MFD	06.00-10.02	66/85	Fg.-Nr. →7M..3..515799	JBH	0 986 480 819		
	1.9 TDI 4Motion	OFD	06.05-09.06	96	Fg.-Nr. →7M..7..506 500	JBH,RLE	0 986 481 047		
	2.0	MFD	06.00-10.02	85	Fg.-Nr. →7M..3..515799	JBH	0 986 480 819		
	2.8	MFD	06.00-04.02	150		JBH	0 986 480 819		
			06.00-10.02	150	Fg.-Nr. →7M..3..515799	JBH	0 986 480 819		
		OFD	06.00-04.02	150		JBH,RLE	0 986 481 047		
	2.8 4Motion	MFD	06.00-04.02	150		JBH	0 986 480 819		
			05.02-10.02	150	Fg.-Nr. →7M..3..515 799	JBH	0 986 480 819		
OFD		06.00-04.02	150		JBH,RLE	0 986 481 047			
		05.02-09.06	150	Fg.-Nr. →7M..7..506 500	JBH,RLE	0 986 481 047			
	1.8 T	06.00-03.10	110				0 986 486 050	19,05	
	1.9 TDI, TDI 4Motion	06.00-03.10	66/85/96/110				0 986 486 050	19,05	
	2.0, TDI	06.00-03.10	85/103				0 986 486 050	19,05	
	2.8, 4Motion	06.00-03.10	150				0 986 486 050	19,05	
	1.8 T	06.00-03.10	110				0 986 486 595	29	
	1.9 TDI, TDI 4Motion	06.00-03.10	66/85/96/110				0 986 486 595	29	
	2.0, TDI	06.00-03.10	85/103				0 986 486 595	29	
	2.8, 4Motion	06.00-03.10	150				0 986 486 595	29	
Alhambra [710]									
									
	1.4 TSI	05.10→	110				0 986 486 595	29	
	2.0 TDI, TDI 4WD	05.10-05.11	85/100/103/125				0 986 486 595	29	
Altea Freerack [5P5, 5P8]									
									
	2.0 TFSI	07.09→	155				0 986 486 595	29	
Altea Freerack [5P5/5P8]									
									
	1.4 TSI	05.10-05.10	92			LLE BO	F 026 003 715	22,2	
						JBH,LLE ATE	0 986 480 870	22	
		06.10→	92			JBH,LLE	0 986 480 870	22	
	1.6 TDI	05.10-05.13	77			LLE BO	F 026 003 715	22,2	
					JBH,LLE ATE	0 986 480 870	22		

		S							
SEAT Altea Freetrack [5P5/5P8]									
	2.0 TDI 4WD	06.07-06.09	125	LLE	BO	F 026	003 715	22,2	
				JBH,LLE	ATE	0986	480 870	22	
		09.10-05.13	125	JBH,LLE,TW		0986	480 870	22	
		10.10→	103	JBH,LLE,TW		0986	480 870	22	
2.0 TFSI 4WD	06.07-06.09	147	LLE	BO	F 026	003 715	22,2		
			JBH,LLE	ATE	0986	480 870	22		
	1.4 TSI	05.10-05.10	92	LLE	BO	0 204	055 051		
	2.0 TDI, TDI 4WD	06.07-10.10	103	LLE	BO	0 204	055 051		
	2.0 TDI 4WD	06.07-06.09	125	LLE,TW		0 204	055 051		
		03.09-10.10	125	LLE	BO	0 204	055 051		
	2.0 TFSI 4WD	06.07-06.09	147	LLE,TW		0 204	055 051		
	1.4 TSI	05.10→	92			0986	486 554	19,05	
	1.6 TDI	05.10-06.11	77			0986	486 576	19	
	2.0 TDI, TDI 4WD	06.07-05.11	103			0986	486 595	29	
	2.0 TDI 4WD	10.10→	103			0986	486 576	19	
	2.0 TDI 4WD, TFSI 4WD	06.07-05.11	125/147			0986	486 595	29	
	2.0 TFSI 4WD	07.09→	155			0986	486 595	29	
Altea XL [5P5]									
	1.2 TSI	04.10-05.10	77	LLE	BO	F 026	003 715	22,2	
				JBH,LLE	ATE	0986	480 870	22	
		06.10→	77	JBH,LLE		0986	480 870	22	
	1.4	10.06-05.13	63	LLE	BO	F 026	003 715	22,2	
				JBH,LLE	ATE	0986	480 870	22	
	1.4 TSI	11.07-05.10	92	LLE	BO	F 026	003 715	22,2	
				JBH,LLE	ATE	0986	480 870	22	
		06.10→	92	JBH,LLE		0986	480 870	22	
	1.6	10.06-05.13	75	LLE	BO	F 026	003 715	22,2	
	1.6 MultiFuel			JBH,LLE	ATE	0986	480 870	22	
	1.6	09.09-05.10	66/72-75	LLE	BO	F 026	003 715	22,2	
	1.6 TDI			JBH,LLE	ATE	0986	480 870	22	
		06.10→	66/72-75	JBH,LLE		0986	480 870	22	
	1.6 TDI	10.09-05.10	77	LLE	BO	F 026	003 715	22,2	
				JBH,LLE	ATE	0986	480 870	22	
		06.10→	77	JBH,LLE		0986	480 870	22	
	1.8 TSI	01.07-05.10	118	LLE	BO	F 026	003 715	22,2	
				JBH,LLE	ATE	0986	480 870	22	
		06.10→	118	JBH,LLE		0986	480 870	22	
	1.9 TDI	10.06-12.10	66/77	LLE	BO	F 026	003 715	22,2	
				JBH,LLE	ATE	0986	480 870	22	
	2.0 FSI, TDI, TFSI	10.06-05.09	110/125/147	LLE	BO	F 026	003 715	22,2	
				JBH,LLE	ATE	0986	480 870	22	
	2.0 TDI	05.06-09.11	103	LLE	BO	F 026	003 715	22,2	
				JBH,LLE	ATE	0986	480 870	22	
		10.06-03.09	100	LLE	BO	F 026	003 715	22,2	
		10.10→	103	JBH,LLE,TW		0986	480 870	22	
	2.0 TDI 4WD	10.10→	103	JBH,LLE,TW		0986	480 870	22	
	1.2 TSI	04.10-05.10	77	LLE	BO	0 204	055 051		
	1.4, TSI	10.06-05.10	63/92	LLE	BO	0 204	055 051		
	1.6	10.06-11.10	75	LLE	BO	0 204	055 051		
	1.6, TDI	09.09-05.10	66/72-75	LLE	BO	0 204	055 051		
	1.6 MultiFuel	12.07-11.10	75	LLE	BO	0 204	055 051		
	1.6 TDI	10.09-05.10	77	LLE	BO	0 204	055 051		
	1.8 TSI	01.07-03.09	118	LLE,TW		0 204	055 051		
		03.09-05.10	118	LLE	BO	0 204	055 051		
	1.9 TDI	10.06-12.10	66/77	LLE	BO	0 204	055 051		
	2.0 FSI	10.06-03.09	110	LLE,TW		0 204	055 051		

		S							
2.0 TDI	05.06-09.11	103				LLE BO	0 204 055 051		
	10.06-03.09	100				LLE,TW	0 204 055 051		
	10.06-05.09	125				LLE,TW	0 204 055 051		
	03.09-05.10	125				LLE BO	0 204 055 051		
2.0 TFSI	10.06-03.09	147				LLE,TW	0 204 055 051		
	1.2 TSI	04.10→	77				0 986 486 554	19,05	
	1.4	10.06-05.13	63				0 986 486 554	19,05	
1.4 TSI	11.07→	92		PR-Code OEJ			0 986 486 576	19	
				PR-Code OEM		0 986 486 554	19,05		
1.6, MultiFuel	10.06→	72-75					0 986 486 554	19,05	
1.6 TDI	10.09→	77					0 986 486 576	19	
	05.10→	66					0 986 486 576	19	
1.8 TSI	01.07-03.09	118					0 986 486 576	19	
	03.09→	118					0 986 486 595	29	
1.9 TDI	10.06-09.10	77					0 986 486 595	29	
	10.06-12.10	77					0 986 486 576	19	
	08.09-12.10	66					0 986 486 576	19	
2.0 FSI	10.06-03.09	110					0 986 486 576	19	
2.0 TDI	05.06-09.11	103					0 986 486 595	29	
	10.06-03.09	100					0 986 486 595	29	
2.0 TDI, TDI 4WD	10.10→	103					0 986 486 576	19	
2.0 TDI, TFSI	10.06-05.10	125/147					0 986 486 595	29	
2.0 TDI 4WD	10.10-05.11	103					0 986 486 595	29	
Altea [5P1]									
									
	1.2 TSI	05.10-05.10	77			LLE BO	F 026 003 715	22,2	
						JBH,LLE ATE	0 986 480 870	22	
1.4	06.10→	77				JBH,LLE	0 986 480 870	22	
						LLE BO	F 026 003 715	22,2	
1.4 TSI	11.07-05.10	92				LLE BO	F 026 003 715	22,2	
						JBH,LLE ATE	0 986 480 870	22	
1.6	06.10→	92				JBH,LLE	0 986 480 870	22	
						LLE BO	F 026 003 715	22,2	
1.6	03.04-05.05	75				JBH,LLE ATE	0 986 480 870	22	
						LLE BO	F 026 003 715	22,2	
1.6	10.05-05.13	75				JBH,LLE ATE	0 986 480 870	22	
						Fg.-Nr. 5P..6..031 760→	JBH,LLE ATE	0 986 480 870	22
1.6	09.09-05.10	66/72-75				LLE BO	F 026 003 715	22,2	
1.6 TDI	06.10→	66/72-75				JBH,LLE ATE	0 986 480 870	22	
						JBH,LLE	0 986 480 870	22	
1.6 MultiFuel	12.07-05.11	75				LLE BO	F 026 003 715	22,2	
1.6 TDI	10.09-05.10	77				JBH,LLE ATE	0 986 480 870	22	
						LLE BO	F 026 003 715	22,2	
1.8 TSI	06.10→	77				JBH,LLE	0 986 480 870	22	
						LLE BO	F 026 003 715	22,2	
1.9 TDI	01.07-05.10	118				JBH,LLE ATE	0 986 480 870	22	
						LLE BO	F 026 003 715	22,2	
2.0 FSI, TDI, TFSI	06.10→	118				JBH,LLE	0 986 480 870	22	
						LLE BO	F 026 003 715	22,2	
2.0 TDI	04.04-12.10	66/77				JBH,LLE ATE	0 986 480 870	22	
						LLE BO	F 026 003 715	22,2	
2.0 TDI	05.04-03.09	110/125/147				JBH,LLE ATE	0 986 480 870	22	
						LLE BO	F 026 003 715	22,2	
2.0 TDI	11.05-03.09	110/125/147				JBH,LLE ATE	0 986 480 870	22	
						LLE BO	F 026 003 715	22,2	
2.0 TDI	03.04-07.11	103				JBH,LLE ATE	0 986 480 870	22	
						LLE BO	F 026 003 715	22,2	
2.0 TDI	04.04-03.09	100				JBH,LLE ATE	0 986 480 870	22	
						LLE BO	F 026 003 715	22,2	
2.0 TDI	10.05-07.11	103				JBH,LLE ATE	0 986 480 870	22	
						LLE BO	F 026 003 715	22,2	
2.0 TDI	09.10→	103				JBH,LLE,TW	0 986 480 870	22	

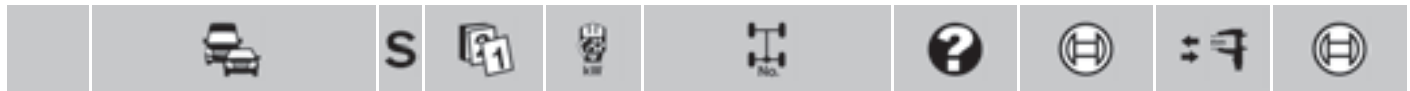











SEAT Altea [5P1]

	1.2 TSI	05.10-05.10	77	LLE	BO	0 204 055 051	
	1.4, TSI	05.06-05.10	63/92	LLE	BO	0 204 055 051	
	1.6	03.04-05.05	75	LLE,TW		0 204 055 051	
		05.05-05.13	75	LLE	BO	0 204 055 051	
	1.6, TDI	09.09-05.10	66/72-75	LLE	BO	0 204 055 051	
	1.6 MultiFuel	12.07-05.11	75	LLE	BO	0 204 055 051	
	1.6 TDI	10.09-05.10	77	LLE	BO	0 204 055 051	
	1.8 TSI	01.07-03.09	118	LLE,TW		0 204 055 051	
		03.09-05.10	118	LLE	BO	0 204 055 051	
	1.9 TDI	04.04-05.06	77	LLE,TW		0 204 055 051	
		10.05-12.10	77	LLE	BO	0 204 055 051	
		08.09-12.10	66	LLE	BO	0 204 055 051	
	2.0 FSI	05.04-03.09	110	LLE,TW		0 204 055 051	
	2.0 TDI	03.04-07.11	103	LLE	BO	0 204 055 051	
		04.04-03.09	100	LLE,TW		0 204 055 051	
11.05-03.09		125	LLE,TW		0 204 055 051		
03.09-05.10		125	LLE	BO	0 204 055 051		
2.0 TFSI	05.06-03.09	147	LLE,TW		0 204 055 051		

	1.2 TSI	05.10→	77			0 986 486 554	19,05
	1.4, TSI	05.06→	63/92			0 986 486 554	19,05
	1.6	03.04-05.05	75			0 986 486 576	19
		09.09→	72-75			0 986 486 554	19,05
	1.6, MultiFuel	05.05-05.13	75			0 986 486 554	19,05
	1.6 TDI	10.09-06.11	77			0 986 486 576	19
		05.10-06.11	66			0 986 486 576	19
	1.8 TSI	01.07-03.09	118			0 986 486 576	19
		03.09→	118			0 986 486 554	19,05
						0 986 486 595	29
	1.9 TDI	04.04-12.10	77			0 986 486 576	19
		10.05-05.10	77			0 986 486 595	29
		08.09-12.10	66			0 986 486 576	19
	2.0 FSI	05.04-03.09	110			0 986 486 576	19
	2.0 TDI	03.04-07.11	103			0 986 486 595	29
04.04-03.09		100			0 986 486 595	29	
2.0 TDI, TFSI	11.05-05.10	125/147			0 986 486 595	29	

Arosa [6H1]

		1.0	ABO	02.97-06.04	37	JBH	F 026 003 562	20,6	
			ABS	02.97-06.04	37	JBH,RLE	0 986 480 869	22	
						PR-Code 1AC, PR-Code 1LA, PR-Code 1LM, PR-Code 1AH, PR-Code 1LB, PR-Code 1ZN	JBH,LLE	0 986 481 013	22,2
						PR-Code 1AC, PR-Code 1ZK, PR-Code 1ZE	JBH,LLE	0 986 481 015	23,81
							JBH	F 026 003 562	20,6
							JBH,RLE	0 986 480 869	22
						PR-Code 1AC, PR-Code 1LA, PR-Code 1LM, PR-Code 1AH, PR-Code 1LB, PR-Code 1ZN	JBH,LLE	0 986 481 013	22,2
						PR-Code 1AC, PR-Code 1ZK, PR-Code 1ZE	JBH,LLE	0 986 481 015	23,81
							JBH	F 026 003 562	20,6
							JBH,RLE	0 986 480 869	22
						PR-Code 1AC, PR-Code 1LA, PR-Code 1LM, PR-Code 1AH, PR-Code 1LB, PR-Code 1ZN	JBH,LLE	0 986 481 013	22,2
						PR-Code 1AC, PR-Code 1ZK, PR-Code 1ZE	JBH,LLE	0 986 481 015	23,81
							JBH	F 026 003 562	20,6
							JBH,RLE	0 986 480 869	22
						PR-Code 1AC, PR-Code 1LA, PR-Code 1LM, PR-Code 1AH, PR-Code 1LB, PR-Code 1ZN	JBH,LLE	0 986 481 013	22,2
			PR-Code 1AC, PR-Code 1ZK, PR-Code 1ZE	JBH,LLE	0 986 481 015	23,81			

		S								
	1.0	02.97-06.04	37			RLE	0 204 125 516			
		10.97-07.00	37				0 204 125 254			
	ABO	02.97-09.99	37				LLE	0 204 125 254		
		05.00-06.04	37				LLE	0 204 125 254		
	1.4	02.97-06.04	44				RLE	0 204 125 516		
		01.99-06.04	44					0 204 125 254		
	ABO	02.97-09.99	44				LLE	0 204 125 254		
		01.98-06.04	55					0 204 125 254		
	1.4 TDI						RLE	0 204 125 516		
								0 204 125 254		
1.4 16V	01.99-09.00	74					0 204 125 254			
	01.99-06.04	74				RLE	0 204 125 516			
	ABO 09.00-06.04	74				LLE	0 204 125 254			
1.7 SDI	08.97-10.03	44					0 204 125 254			
						RLE	0 204 125 516			
Cordoba Vario [6K5]										
										
	1.4	ABO 05.97-08.97	44				JBH	F 026 003 562	20,6	
		09.97-05.98	44	Fg.-Nr. →6K..X..008 000			JBH,RLE	F 026 003 562	20,6	
		09.97-12.02	44				JBH,LLE	F 026 003 562	20,6	
		12.97-12.02	44				JBH	F 026 003 562	20,6	
		06.98-12.02	44	Fg.-Nr. 6K..X..008 001→			RLE	0 204 123 520	20,6	
		05.99-12.02	44				JBH,LLE	F 026 003 563	22	
							RLE	0 204 123 521	22,22	
		05.99-08.03	55/74				JBH,LLE	F 026 003 563	22	
							RLE	0 204 123 521	22,22	
		ABS 05.97-08.03	44/55/74				JBH,LLE	0 986 480 987	23,81	
							0 986 481 016	22,2		
						JBH,RLE	0 986 480 869	22		
	1.6	10.99-10.04	76				JBH	F 026 003 563	22	
		ABO 04.97-05.98	74	Fg.-Nr. →6K..X..008 000			JBH,RLE	F 026 003 563	22	
		04.97-12.02	74				JBH,LLE	F 026 003 563	22	
		05.97-05.98	55	Fg.-Nr. →6K..X..008 000			JBH,RLE	F 026 003 562	20,6	
		05.97-08.02	55				JBH,LLE	F 026 003 562	20,6	
		06.98-06.99	74	Fg.-Nr. 6K..X..008 001→			RLE	0 204 123 521	22,22	
		06.98-08.02	55	Fg.-Nr. 6K..X..008 001→			RLE	0 204 123 520	20,6	
		05.99-12.02	74				RLE	0 204 123 521	22,22	
ABS 04.97-12.02		55/74				JBH,LLE	0 986 480 987	23,81		
							0 986 481 016	22,2		
					JBH,RLE	0 986 480 869	22			
1.8	ABO 07.96-05.98	66	Fg.-Nr. →6K..X..008 000			JBH,RLE	F 026 003 562	20,6		
	07.96-06.99	66				JBH,LLE	F 026 003 562	20,6		
	06.98-06.99	66	Fg.-Nr. 6K..X..008 001→			RLE	0 204 123 520	20,6		
	ABS 07.96-06.99	66				JBH,LLE	0 986 480 987	23,81		
							0 986 481 016	22,2		
					JBH,RLE	0 986 480 869	22			
1.9 SDI	ABO 06.97-05.98	47	Fg.-Nr. →6K..X..008 000			JBH,RLE	F 026 003 562	20,6		
	06.97-06.99	47				JBH,LLE	F 026 003 562	20,6		
	06.98-06.99	47	Fg.-Nr. 6K..X..008 001→			RLE	0 204 123 520	20,6		
	05.99-08.02	50				JBH,LLE	F 026 003 563	22		
						RLE	0 204 123 521	22,22		
ABS 06.97-08.02	47/50				JBH,LLE	0 986 480 987	23,81			
						0 986 481 016	22,2			
					JBH,RLE	0 986 480 869	22			
1.9 TDI	05.99-08.02	66				JBH,LLE	F 026 003 563	22		
	ABO 06.97-05.98	66	Fg.-Nr. →6K..X..008 000			JBH,RLE	F 026 003 563	22		
	06.97-06.99	66				JBH,LLE	F 026 003 563	22		
	02.98-05.98	81	Fg.-Nr. →6K..X..008 000			JBH,RLE	F 026 003 563	22		
	02.98-08.02	81				JBH,LLE	F 026 003 563	22		
	06.98-06.99	66	Fg.-Nr. 6K..X..008 001→			RLE	0 204 123 521	22,22		
		81	Fg.-Nr. 6K..X..008 001→			RLE	0 204 123 521	22,22		









SEAT Cordoba Vario [6K5]												
	1.9 TDI	ABO	05.99-08.02	66		RLE	0 204 123 521	22,22				
				81		RLE	0 204 123 521	22,22				
		ABS	06.97-06.99	66/81			JBH,LLE	0 986 481 016	22,2			
							JBH,RLE	0 986 480 869	22			
					06.97-08.02	66/81		JBH,LLE	0 986 480 987	23,81		
	08.00-08.02	66/81	Fg.-Nr. 6K..1..111 610→		RLE	0 204 055 389						
	1.4	ABO	05.97-12.02	44		1AB,RLE	0 204 125 264					
						1AG,LLE	0 204 125 262					
						1AG,RLE	0 204 125 263					
						1AL,RLE	0 204 125 517					
						05.99-12.02	44		LLE	0 204 125 262		
						RLE	0 204 125 263					
			05.99-08.03	55/74		LLE	0 204 125 262					
						RLE	0 204 125 263					
			1.6	ABO	04.97-06.99	74		1AB,RLE	0 204 125 264			
								1AG,LLE	0 204 125 262			
	1AG,RLE						0 204 125 263					
	1AL,RLE						0 204 125 517					
	05.97-08.02						55		1AB,RLE	0 204 125 264		
						1AG,LLE	0 204 125 262					
						1AG,RLE	0 204 125 263					
						1AL,RLE	0 204 125 517					
	05.99-12.02			74		LLE	0 204 125 262					
						RLE	0 204 125 263					
	1.8	ABO	07.96-06.99	66		1AB,RLE	0 204 125 264					
						1AG,LLE	0 204 125 262					
						1AG,RLE	0 204 125 263					
						1AL,RLE	0 204 125 517					
	1.9 SDI	ABO	06.97-06.99	47		1AB,RLE	0 204 125 264					
						1AG,LLE	0 204 125 262					
						1AG,RLE	0 204 125 263					
						1AL,RLE	0 204 125 517					
						05.99-08.02	50		LLE	0 204 125 262		
				RLE	0 204 125 263							
	1.9 TDI	ABO	06.97-06.99	66/81		1AB,RLE	0 204 125 264					
						1AG,LLE	0 204 125 262					
						1AG,RLE	0 204 125 263					
						1AL,RLE	0 204 125 517					
			05.99-08.02	66/81		LLE	0 204 125 262					
						RLE	0 204 125 263					
	ABS	09.00-08.02	66/81	Fg.-Nr. 6K..1..111 610→		RLE	0 204 055 380					
	1.6		06.99-08.02	74		LLE	0 986 486 109	15,8				
					1.9 SDI	06.97-06.99	47		LLE	0 986 486 038	19	
								05.99-08.02	50		LLE	0 986 486 109
					1.9 TDI	06.97-06.99	66/81		LLE	0 986 486 038	19	
								05.99-08.02	66/81		LLE	0 986 486 109
	1.6		06.99-08.02	74			0 986 486 542	23,81				
					1.9 SDI	06.97-06.99	47			0 986 486 537	23,8	
								05.99-08.02	50		0 986 486 542	23,81
					1.9 TDI	06.97-06.99	66/81			0 986 486 537	23,8	
								05.99-08.02	66/81		0 986 486 538	19
	1.4		05.97-08.03	44/55/74			0 204 131 697 ^A					
					1.6	04.97-12.02	55/74			0 204 131 697 ^A		
								07.96-06.99	66		0 204 131 697 ^A	
					1.9 SDI	05.99-08.02	50			0 204 131 697 ^A		
					1.9 TDI	05.99-08.02	66/81		GS	0 204 131 697 ^A		



Cordoba [6K2]

	1.0	ABO	09.96-05.98	37	Fg.-Nr. →6K..X..008 000	JBH,RLE	F 026 003 562	20,6
			09.96-06.99	37		JBH,LLE	F 026 003 562	20,6
			06.98-06.99	37	Fg.-Nr. 6K..X..008 001→	RLE	0 204 123 520	20,6
			05.99-12.02	37		JBH,LLE	F 026 003 563	22
						RLE	0 204 123 521	22,22
			05.00-12.02	51		JBH,LLE	F 026 003 563	22
						RLE	0 204 123 521	22,22
		ABS	09.96-12.02	37/51		JBH,LLE	0 986 480 987	23,81
							0 986 481 016	22,2
						JBH,RLE	0 986 480 869	22
	1.4	ABO	09.93-05.98	44		JBH	F 026 003 562	20,6
			07.96-05.98	74	Fg.-Nr. →6K..X..008 000	JBH,RLE	F 026 003 562	20,6
			07.96-12.02	74		JBH,LLE	F 026 003 562	20,6
			12.97-05.98	44	Fg.-Nr. →6K..X..008 000	JBH,RLE	F 026 003 562	20,6
			12.97-06.99	44		JBH,LLE	F 026 003 562	20,6
			06.98-06.99	44	Fg.-Nr. 6K..X..008 001→	RLE	0 204 123 520	20,6
			06.98-12.02	74	Fg.-Nr. 6K..X..008 001→	RLE	0 204 123 520	20,6
			05.99-12.02	44		JBH,LLE	F 026 003 563	22
						RLE	0 204 123 521	22,22
			09.99-12.02	55		JBH,LLE	F 026 003 563	22
						RLE	0 204 123 521	22,22
				74		JBH,LLE	F 026 003 563	22
						RLE	0 204 123 521	22,22
		ABS	10.95-12.95	44	Fg.-Nr. 6K..TR069 487→	JBH,LLE	0 986 480 987	23,81
							0 986 481 016	22,2
						JBH,RLE	0 986 480 869	22
			01.96-12.02	44		JBH,LLE	0 986 480 987	23,81
							0 986 481 016	22,2
						JBH,RLE	0 986 480 869	22
			07.96-12.02	55/74		JBH,LLE	0 986 480 987	23,81
							0 986 481 016	22,2
						JBH,RLE	0 986 480 869	22
	1.6		09.93-07.94	55		JBH	F 026 003 562	20,6
			10.99-10.04	74		JBH	F 026 003 563	22
		ABO	05.94-05.98	55	Fg.-Nr. →6K..X..008 000	JBH,RLE	F 026 003 562	20,6
			05.94-12.02	55		JBH,LLE	F 026 003 562	20,6
			12.95-05.98	74	Fg.-Nr. →6K..X..008 000	JBH,RLE	F 026 003 563	22
			12.95-12.02	74		JBH,LLE	F 026 003 563	22
			06.98-11.02	74	Fg.-Nr. 6K..X..008 001→	RLE	0 204 123 521	22,22
			06.98-12.02	55	Fg.-Nr. 6K..X..008 001→	RLE	0 204 123 520	20,6
			05.99-12.02	74		RLE	0 204 123 521	22,22
		ABS	10.95-06.99	55	Fg.-Nr. 6K..TR069 487→	JBH,LLE	0 986 480 987	23,81
							0 986 481 016	22,2
						JBH,RLE	0 986 480 869	22
			12.95-12.02	74		JBH,LLE	0 986 480 987	23,81
							0 986 481 016	22,2
						JBH,RLE	0 986 480 869	22
			03.97-12.02	55		JBH,LLE	0 986 480 987	23,81
							0 986 481 016	22,2
						JBH,RLE	0 986 480 869	22
	1.8	ABO	09.93-07.94	66		JBH	F 026 003 562	20,6
			09.93-06.96	95		JBH,RLE	F 026 003 563	22
			07.94-05.98	66	Fg.-Nr. →6K..X..008 000	JBH,RLE	F 026 003 562	20,6
			07.94-12.02	66		JBH,LLE	F 026 003 562	20,6
			06.98-12.02	66	Fg.-Nr. 6K..X..008 001→	RLE	0 204 123 520	20,6
		ABS	09.93-09.95	95	Fg.-Nr. →6K..TR069 486	JBH,LLE	0 986 480 878	23,8
			10.95-06.96	95	Fg.-Nr. 6K..TR069 487→	JBH,LLE	0 986 480 987	23,81
							0 986 481 016	22,2
						JBH,RLE	0 986 480 869	22

		S								
SEAT Cordoba [6K2]										
1.8	ABS	10.95-12.02	66	Fg.-Nr. 6K..TR069 487→	JBH, LLE	0 986 480 987	23,81			
						0 986 481 016	22,2			
1.8 T Cupra	ASR	05.99-12.02	115		RLE	0 986 480 869	22			
						0 204 055 389				
1.9 D	ABS	10.95-12.02	47-50	Fg.-Nr. 6K..TR069 487→	JBH, LLE	0 986 480 987	23,81			
						0 986 481 016	22,2			
1.9 D	ABO	09.93-05.98	47-50	Fg.-Nr. →6K..X..008 000	JBH, RLE	0 986 480 869	22			
						F 026 003 562	20,6			
1.9 SDI	ASR	05.99-12.02	115		JBH, LLE	0 986 480 987	23,81			
						0 204 123 520	20,6			
1.9 SDI	ABO	05.99-08.02	50		JBH, LLE	0 986 480 987	23,81			
						0 986 481 016	22,2			
1.9 SDI	ABS	12.95-12.02	47		JBH, LLE	0 986 480 987	23,81			
						0 986 481 016	22,2			
1.9 SDI	ABO	05.99-08.02	50		JBH, LLE	0 986 480 987	23,81			
						0 986 481 016	22,2			
1.9 TD	ABO	09.93-08.97	55		JBH	F 026 003 562	20,6			
						0 986 480 987	23,81			
1.9 TD	ABS	10.95-08.97	55	Fg.-Nr. 6K..TR069 487→	JBH, LLE	0 986 480 987	23,81			
						0 986 481 016	22,2			
1.9 TDI	ABO	07.96-05.98	66	Fg.-Nr. →6K..X..008 000	JBH, RLE	0 986 480 869	22			
						F 026 003 563	22			
1.9 TDI	ASR	07.96-06.99	66		JBH	F 026 003 563	22			
						0 204 123 521	22,22			
1.9 TDI	ABO	07.96-12.02	66		JBH, LLE	0 986 480 987	23,81			
						0 986 481 016	22,2			
1.9 TDI	ASR	03.97-05.98	81	Fg.-Nr. →6K..X..008 000	JBH, RLE	F 026 003 563	22			
						0 204 123 521	22,22			
1.9 TDI	ABO	03.97-12.02	81		JBH, LLE	0 986 480 987	23,81			
						0 986 481 016	22,2			
1.9 TDI	ASR	06.98-06.99	66	Fg.-Nr. 6K..X..008 001→	RLE	0 204 123 521	22,22			
						0 204 123 521	22,22			
1.9 TDI	ABO	05.99-12.02	66		RLE	0 204 123 521	22,22			
						0 204 123 521	22,22			
1.9 TDI	ABS	07.96-06.99	66		JBH, RLE	0 986 480 869	22			
						0 986 480 987	23,81			
1.9 TDI	ASR	07.96-12.02	66		JBH, LLE	0 986 480 987	23,81			
						0 986 481 016	22,2			
1.9 TDI	ABO	03.97-06.99	81		JBH, LLE	0 986 480 987	23,81			
						0 986 481 016	22,2			
1.9 TDI	ASR	08.00-12.02	66	Fg.-Nr. 6K..1..111 610→	RLE	0 986 480 869	22			
						0 204 055 389				
1.9 TDI	ASR	05.99-12.02	81		JBH, LLE	0 986 480 987	23,81			
						0 986 481 016	22,2			
2.0	ABO	06.96-12.02	110		JBH, LLE	0 986 480 987	23,81			
						0 986 481 016	22,2			
2.0	ASR	09.93-04.96	85		JBH, RLE	0 986 480 869	22			
						F 026 003 563	22			
2.0	ABO	04.96-03.97	85	Fg.-Nr. →6K..V..150 000	JBH, RLE	0 986 480 987	23,81			
						0 986 481 016	22,2			
2.0	ASR	04.96-12.02	85		JBH, LLE	0 986 480 987	23,81			
						0 986 481 016	22,2			
2.0	ABO	06.98-12.02	85	Fg.-Nr. 6K..X..008 001→	RLE	0 204 123 521	22,22			
						0 204 123 521	22,22			
2.0	ABS	09.93-09.95	85	Fg.-Nr. →6K..TR069 486	JBH, LLE	0 986 480 878	23,8			
						0 986 480 987	23,81			
2.0	ASR	10.95-04.96	85	Fg.-Nr. 6K..TR069 487→	JBH, LLE	0 986 480 987	23,81			
						0 986 481 016	22,2			
2.0	ABO	04.96-12.02	85		JBH, LLE	0 986 480 869	22			
						0 986 480 987	23,81			
2.0	ASR	09.93-09.95	85		JBH, RLE	0 986 480 869	22			
						0 986 481 016	22,2			
2.0	ABO	04.96-12.02	85		JBH, LLE	0 986 480 987	23,81			
						0 986 481 016	22,2			
2.0	ASR	09.93-09.95	85		JBH, RLE	0 986 480 869	22			
						0 986 481 016	22,2			
1.0	ABO	09.96-06.99	37		1AB, RLE	0 204 125 264				
						0 204 125 262				
1.0	ASR	09.96-06.99	37		1AG, LLE	0 204 125 262				
						0 204 125 263				
1.0	ABO	09.96-06.99	37		1AL, RLE	0 204 125 517				
						0 204 125 262				
1.0	ASR	09.96-06.99	37		LLE	0 204 125 262				
						0 204 125 263				

										
1.0	ABO	05.00-12.02	51			LLE	0 204 125 262			
						RLE	0 204 125 263			
1.4	ABO	09.93-06.99	44			1AB,RLE	0 204 125 264			
						1AG,LLE	0 204 125 262			
						1AG,RLE	0 204 125 263			
						1AL,RLE	0 204 125 517			
		07.96-12.02	74				1AB,RLE	0 204 125 264		
							1AG,LLE	0 204 125 262		
							1AG,RLE	0 204 125 263		
							1AL,RLE	0 204 125 517		
		05.99-12.02	44				LLE	0 204 125 262		
							RLE	0 204 125 263		
		09.99-12.02	55				LLE	0 204 125 262		
							RLE	0 204 125 263		
LLE							0 204 125 262			
RLE							0 204 125 263			
1.6	ABO	09.93-07.94	55			1AB,RLE	0 204 125 264			
						1AG,LLE	0 204 125 262			
						1AG,RLE	0 204 125 263			
						1AL,RLE	0 204 125 517			
		05.94-12.02	55				1AB,RLE	0 204 125 264		
							1AG,LLE	0 204 125 262		
							1AG,RLE	0 204 125 263		
							1AL,RLE	0 204 125 517		
		12.95-11.02	74				1AB,RLE	0 204 125 264		
							1AG,LLE	0 204 125 262		
							1AG,RLE	0 204 125 263		
							1AL,RLE	0 204 125 517		
	05.99-12.02	74				LLE	0 204 125 262			
						RLE	0 204 125 263			
1.8	ABO	09.93-12.02	66/95			1AB,RLE	0 204 125 264			
						1AG,LLE	0 204 125 262			
						1AG,RLE	0 204 125 263			
						1AL,RLE	0 204 125 517			
1.8 T Cupra	ABO	05.99-12.02	115			LLE	0 204 125 262			
						RLE	0 204 125 263			
1.9 D 1.9 SDI	ABO	09.93-12.02	47-50			1AB,RLE	0 204 125 264			
						1AG,LLE	0 204 125 262			
						1AG,RLE	0 204 125 263			
						1AL,RLE	0 204 125 517			
1.9 SDI	ABO	05.99-08.02	50			LLE	0 204 125 262			
						RLE	0 204 125 263			
1.9 TD	ABO	09.93-08.97	55			1AB,RLE	0 204 125 264			
						1AG,LLE	0 204 125 262			
						1AG,RLE	0 204 125 263			
						1AL,RLE	0 204 125 517			
1.9 TDI	ABO	07.96-06.99	66/81			1AB,RLE	0 204 125 264			
						1AG,LLE	0 204 125 262			
						1AG,RLE	0 204 125 263			
		05.99-12.02	66/81				LLE	0 204 125 262		
							RLE	0 204 125 263		
							RLE	0 204 055 380		
2.0	ABO	09.93-12.02	85			1AB,RLE	0 204 125 264			
						1AG,LLE	0 204 125 262			
						1AG,RLE	0 204 125 263			
						1AL,RLE	0 204 125 517			
		06.96-12.02	110				1AB,RLE	0 204 125 264		
							1AG,LLE	0 204 125 262		
							1AG,RLE	0 204 125 263		
							1AL,RLE	0 204 125 517		
		ABS	06.96-12.02	110			RLE	0 204 125 263		



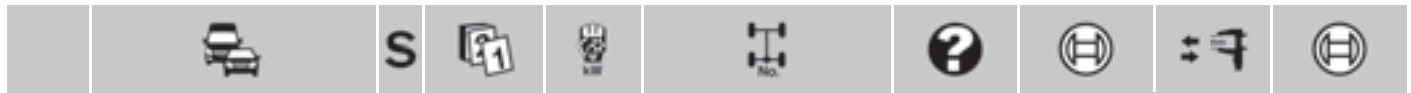











SEAT Cordoba [6K2]

	1.6	05.99-12.02	74	LLE	0986 486 109	15,8
	1.8 T Cupra	05.99-12.02	115	LLE	0986 486 109	15,8
	1.9 SDI	12.95-12.02	47	LLE	0986 486 038	19
		05.99-08.02	50	LLE	0986 486 109	15,8
	1.9 TDI	07.96-06.99	66/81	LLE	0986 486 038	19
05.99-12.02		66/81	LLE	0986 486 109	15,8	
	1.6	05.99-12.02	74		0986 486 542	23,81
	1.8 T Cupra	05.99-12.02	115		0986 486 538	19
	1.9 SDI	12.95-12.02	47		0986 486 537	23,8
		05.99-08.02	50		0986 486 542	23,81
	1.9 TDI	07.96-06.99	66/81		0986 486 537	23,8
05.99-12.02		66/81		0986 486 538	19	
	1.0	05.99-12.02	37/51		0204 131 697 ^A	
	1.4	09.93-12.02	44/55/74		0204 131 697 ^A	
	1.6	09.93-12.02	55/74		0204 131 697 ^A	
	1.8, T Cupra	09.93-12.02	66/95/115		0204 131 697 ^A	
	1.9 SDI	05.99-08.02	50		0204 131 697 ^A	
	1.9 TDI	05.99-12.02	66/81	GS	0204 131 697 ^A	
	2.0	09.93-12.02	85/110		0204 131 697 ^A	

Cordoba [6L2]











	S		1.2	ABO	10.02-04.04	47		JBH	0986 480 850	20,6	
					11.04-06.06	47		JBH	0986 480 850	20,6	
					05.06-11.09	51		JBH	0986 480 850	20,6	
				ABS	10.02-04.04	47		JBH	0986 480 820	20,6	
					11.04-06.06	47		JBH	0986 480 820	20,6	
					05.06-07.06	51	Fg.-Nr. →6L..7..048 489	JBH	0986 480 820	20,6	
				1.4	ABS	09.02-12.07	55		JBH	0986 480 820	20,6
						10.02-11.06	74	Fg.-Nr. →6L..7..048 489	JBH	0986 480 820	20,6
				1.4	ABO	09.02-11.09	51/55/58/		JBH	0986 480 850	20,6
				1.4 TDI	ABS	05.06-07.06	59/63	Fg.-Nr. →6L..7..048 489	JBH	0986 480 820	20,6
							59/63/74		JBH	0986 480 820	20,6
				1.4 TDI	ABS	10.02-12.05	55	Fg.-Nr. →6L..7..048 489	JBH	0986 480 820	20,6
						05.05-11.09	51	Fg.-Nr. →6L..7..048 489	JBH	0986 480 820	20,6
							58	Fg.-Nr. →6L..7..048 489	JBH	0986 480 820	20,6
				1.6	ABO	04.03-11.09	74/77		JBH	0986 480 850	20,6
						04.03-11.09	74	Fg.-Nr. →6L..7..048 489	JBH	0986 480 820	20,6
				1.9 SDI	ABO	09.02-12.05	47		JBH	0986 480 850	20,6
				1.9 SDI, TDI	ABS	09.02-11.09	47/74/96	Fg.-Nr. →6L..7..048 489	JBH	0986 480 820	20,6
				1.9 TDI	ABO	09.02-11.09	74		JBH	0986 480 850	20,6
						10.02-11.09	96		JBH	0986 480 850	20,6
2.0	ABO	09.02-11.09	85		JBH	0986 480 850	20,6				
		09.02-04.05	85		JBH	0986 480 820	20,6				
		04.03-11.09	85	Fg.-Nr. →6L..7..048 489	JBH	0986 480 820	20,6				
			1.2		10.02-04.04	47			0986 486 060	15,87	
					11.04-06.06	47			0986 486 060	15,87	
					05.06-11.09	51			0986 486 060	15,87	
				1.4, TDI	09.02-11.09	51/55/58/59/63/74			0986 486 060	15,87	
				1.6	04.03-11.09	74/77			0986 486 060	15,87	
1.9 SDI, TDI	09.02-11.09	47/74/96			0986 486 060	15,87					
2.0	09.02-11.09	85			0986 486 060	15,87					
			1.2		10.02-04.04	47	PR-Code OEJ		0986 486 553	19,05	
							PR-Code OEM		0986 486 554	19,05	
					11.04-06.06	47	PR-Code OEJ		0986 486 553	19,05	
							PR-Code OEM		0986 486 554	19,05	

		S							
1.2		05.06-11.09	51	PR-Code OEJ			0 986 486 553	19,05	
				PR-Code OEM			0 986 486 554	19,05	
1.4		09.02-11.09	51/55/58/	PR-Code OEJ			0 986 486 553	19,05	
1.4 TDI			59/63/74	PR-Code OEM			0 986 486 554	19,05	
1.6		04.03-11.09	74/77	PR-Code OEJ			0 986 486 553	19,05	
				PR-Code OEM			0 986 486 554	19,05	
1.9 SDI		09.02-11.09	47/74	PR-Code OEJ			0 986 486 553	19,05	
1.9 TDI				PR-Code OEM			0 986 486 554	19,05	
1.9 TDI		10.02-11.09	96				0 986 486 595	29	
				PR-Code OEJ			0 986 486 553	19,05	
				PR-Code OEM			0 986 486 554	19,05	
2.0		09.02-11.09	85	PR-Code OEJ			0 986 486 553	19,05	
				PR-Code OEM			0 986 486 554	19,05	
 1.2		10.02-04.04	47				0 204 131 682 ^A		
		11.04-06.06	47				0 204 131 682 ^A		
		05.06-11.09	51				0 204 131 682 ^A		
1.4, TDI		09.02-11.09	51/55/58/59/63/74				0 204 131 682 ^A		
1.6		04.03-11.09	74				0 204 131 682 ^A		
1.9 SDI, TDI		09.02-11.09	47/74/96				0 204 131 682 ^A		
2.0		09.02-11.09	85				0 204 131 682 ^A		
 1.2		10.02-04.04	47				0 265 224 013 ^F		
							0 265 225 162 ^T		
		11.04-05.05	47	Fg.-Nr. →6L..6..000 000			0 265 232 252 ^F		
							0 265 234 119 ^T		
		11.04-05.06	47	Fg.-Nr. →6L..9..000 001			0 265 231 436 ^B		
		06.05-02.06	47	Fg.-Nr. 6L..6..000 001 → 6L..6..523 398	RDK		0 265 234 363 ^T		
		06.05-06.06	47	Fg.-Nr. 6L..6..000 001 →	RDK		0 265 232 252 ^F		
					RDK		0 265 232 255 ^F		
							0 265 234 703 ^T		
		03.06-06.06	47	Fg.-Nr. 6L..6..523 399 →	RDK		0 265 234 700 ^T		
		05.06-11.09	51		RDK		0 265 232 246 ^B		
							0 265 232 252 ^F		
							0 265 234 700 ^T		
					RDK		0 265 232 249 ^B		
							0 265 232 255 ^F		
							0 265 234 703 ^T		
		06.06-06.06	47	Fg.-Nr. 6L..9..000 002 →	RDK		0 265 232 246 ^B		
					RDK		0 265 232 249 ^B		
1.4		09.02-04.04	55				0 265 224 013 ^F		
							0 265 225 162 ^T		
		10.02-04.04	74	Fg.-Nr. →6L..4..231 600			0 265 225 162 ^T		
		10.02-05.05	74	Fg.-Nr. →6L..6..000 000			0 265 232 252 ^F		
		05.04-05.05	55	Fg.-Nr. →6L..6..000 000			0 265 232 252 ^F		
							0 265 234 119 ^T		
			74	Fg.-Nr. 6L..4..231 601 →6L..6..000 000			0 265 234 119 ^T		
		06.04-05.06	55	Fg.-Nr. 6L..4..231 601 →6L..9..000 001			0 265 231 436 ^B		
			74	Fg.-Nr. 6L..4..231 601 →6L..9..000 001			0 265 231 436 ^B		
		06.05-02.06	55	Fg.-Nr. 6L..6..000 001 → 6L..6..523 398	RDK		0 265 234 363 ^T		
			74	Fg.-Nr. 6L..6..000 001 → 6L..6..523 398	RDK		0 265 234 363 ^T		
		06.05-11.06	74	Fg.-Nr. 6L..6..000 001 →	RDK		0 265 232 252 ^F		
					RDK		0 265 232 255 ^F		
							0 265 234 703 ^T		
		06.05-12.07	55	Fg.-Nr. 6L..6..000 001 →	RDK		0 265 232 252 ^F		
					RDK		0 265 234 703 ^T		
		03.06-11.06	74	Fg.-Nr. 6L..6..523 399 →	RDK		0 265 234 700 ^T		
		03.06-12.07	55	Fg.-Nr. 6L..6..523 399 →	RDK		0 265 234 700 ^T		

			S						
◀ SEAT Cordoba [6L2]									
1.4	06.06-11.06	74	Fg.-Nr. 6L..9..000 002→	RDK	0 265 232 246 ^B				
				RDK	0 265 232 249 ^B				
	06.06-12.07	55	Fg.-Nr. 6L..9..000 002→	RDK	0 265 232 246 ^B				
				RDK	0 265 232 249 ^B				
1.4	06.05-12.07	55	Fg.-Nr. 6L..6..000 001→	RDK	0 265 232 255 ^F				
1.4 TDI	05.06-11.09	59/63		RDK	0 265 232 246 ^B				
					0 265 232 252 ^F				
					0 265 234 700 ^T				
				RDK	0 265 232 249 ^B				
					0 265 232 255 ^F				
					0 265 234 703 ^T				
1.4 TDI	10.02-04.04	55	Fg.-Nr. →6L..4..231 600		0 265 225 162 ^T				
	10.02-05.05	55	Fg.-Nr. →6L..6..000 000		0 265 232 252 ^F				
	05.04-05.05	55	Fg.-Nr. 6L..4..231 601→6L..6..000 000		0 265 234 119 ^T				
	06.04-12.05	55	Fg.-Nr. 6L..4..231 601→		0 265 231 436 ^B				
	05.05-05.05	51	Fg.-Nr. →6L..6..000 000		0 265 232 252 ^F				
					0 265 234 119 ^T				
		58	Fg.-Nr. →6L..6..000 000		0 265 232 252 ^F				
					0 265 234 119 ^T				
	05.05-05.06	51	Fg.-Nr. →6L..9..000 001		0 265 231 436 ^B				
					0 265 231 436 ^B				
	06.05-12.05	55	Fg.-Nr. 6L..6..000 001→	RDK	0 265 232 252 ^F				
					0 265 234 363 ^T				
				RDK	0 265 234 703 ^T				
	06.05-02.06	51	Fg.-Nr. 6L..6..000 001→ 6L..6..523 398	RDK	0 265 234 363 ^T				
		58	Fg.-Nr. 6L..6..000 001→ 6L..6..523 398	RDK	0 265 234 363 ^T				
	06.05-11.09	51	Fg.-Nr. 6L..6..000 001→	RDK	0 265 232 252 ^F				
					0 265 232 255 ^F				
					0 265 234 703 ^T				
		58	Fg.-Nr. 6L..6..000 001→	RDK	0 265 232 252 ^F				
				RDK	0 265 232 255 ^F				
				0 265 234 703 ^T					
03.06-11.09	51	Fg.-Nr. 6L..6..523 399→	RDK	0 265 234 700 ^T					
				0 265 234 700 ^T					
06.06-11.09	51	Fg.-Nr. 6L..9..000 002→	RDK	0 265 232 246 ^B					
				0 265 232 249 ^B					
	58	Fg.-Nr. 6L..9..000 002→	RDK	0 265 232 246 ^B					
			RDK	0 265 232 249 ^B					
1.6	04.03-04.04	74	Fg.-Nr. →6L..4..231 600		0 265 225 162 ^T				
	04.03-05.05	74	Fg.-Nr. →6L..6..000 000		0 265 232 252 ^F				
	05.04-05.05	74	Fg.-Nr. 6L..4..231 601→6L..6..000 000		0 265 234 119 ^T				
	06.04-05.06	74	Fg.-Nr. 6L..4..231 601→6L..9..000 001		0 265 231 436 ^B				
	06.05-02.06	74	Fg.-Nr. 6L..6..000 001→ 6L..6..523 398	RDK	0 265 234 363 ^T				
	06.05-11.09	74	Fg.-Nr. 6L..6..000 001→	RDK	0 265 232 252 ^F				
					0 265 232 255 ^F				
					0 265 234 703 ^T				
	03.06-11.09	74	Fg.-Nr. 6L..6..523 399→	RDK	0 265 234 700 ^T				
	06.06-11.09	74	Fg.-Nr. 6L..9..000 002→	RDK	0 265 232 246 ^B				
					0 265 232 249 ^B				
11.06-11.09	77		RDK	0 265 232 246 ^B					
				0 265 232 252 ^F					
				0 265 234 700 ^T					
			RDK	0 265 232 249 ^B					
				0 265 232 255 ^F					
				0 265 234 703 ^T					
1.9 SDI	09.02-04.04	47	Fg.-Nr. →6L..4..231 600		0 265 225 162 ^T				
	09.02-05.05	47	Fg.-Nr. →6L..6..000 000		0 265 232 252 ^F				
	05.04-05.05	47	Fg.-Nr. 6L..4..231 601→6L..6..000 000		0 265 234 119 ^T				
	06.04-12.05	47	Fg.-Nr. 6L..4..231 601→		0 265 231 436 ^B				







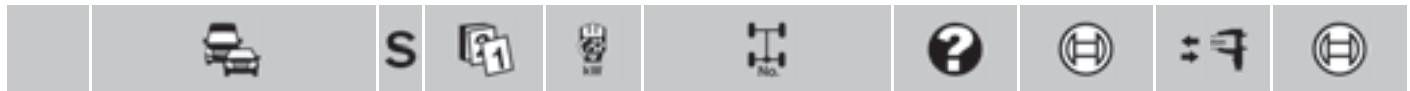



		S								
1.9 SDI	06.05-12.05	47	Fg.-Nr. 6L..6..000 001→	RDK			0 265 232 252 ^F			
							0 265 234 363 ^T			
							RDK	0 265 232 255 ^F		
								0 265 234 703 ^T		
1.9 TDI	09.02-04.04	74	Fg.-Nr. →6L..4..231 600				0 265 225 162 ^T			
	09.02-05.05	74	Fg.-Nr. →6L..6..000 000				0 265 232 252 ^F			
	10.02-04.04	96	Fg.-Nr. →6L..4..231 600				0 265 225 162 ^T			
	10.02-05.05	96	Fg.-Nr. →6L..6..000 000				0 265 232 252 ^F			
	05.04-05.05	96	Fg.-Nr. 6L..4..231 601→6L..6..000 000				0 265 234 119 ^T			
	05.04-07.05	74	Fg.-Nr. 6L..4..231 601→				0 265 234 119 ^T			
	06.04-07.05	74	Fg.-Nr. 6L..4..231 601→				0 265 231 436 ^B			
	06.04-09.05	96	Fg.-Nr. 6L..4..231 601→				0 265 231 436 ^B			
	05.05-05.05	74	Fg.-Nr. →6L..6..000 000				0 265 234 119 ^T			
		96	Fg.-Nr. →6L..6..000 000				0 265 234 119 ^T			
	05.05-05.06	74	Fg.-Nr. →6L..9..000 001				0 265 231 436 ^B			
	96	Fg.-Nr. →6L..9..000 001					0 265 231 436 ^B			
		06.05-09.05	96	Fg.-Nr. 6L..6..000 001→	RDK		0 265 234 363 ^T			
	06.05-02.06	74	Fg.-Nr. 6L..6..000 001→	RDK			0 265 234 363 ^T			
		96	Fg.-Nr. 6L..6..000 001→	RDK			0 265 234 363 ^T			
	6L..6..523 398	74	Fg.-Nr. 6L..6..000 001→	RDK			0 265 232 252 ^F			
		96	Fg.-Nr. 6L..6..000 001→	RDK			0 265 232 255 ^F			
	06.05-11.09	74	Fg.-Nr. 6L..6..000 001→	RDK			0 265 234 703 ^T			
		96	Fg.-Nr. 6L..6..000 001→	RDK			0 265 232 252 ^F			
	RDK						0 265 232 255 ^F			
							0 265 234 703 ^T			
	03.06-11.09	74	Fg.-Nr. 6L..6..523 399→	RDK			0 265 234 700 ^T			
		96	Fg.-Nr. 6L..6..523 399→	RDK			0 265 234 700 ^T			
	06.06-11.09	74	Fg.-Nr. 6L..9..000 002→	RDK			0 265 232 246 ^B			
		RDK					0 265 232 249 ^B			
	96	Fg.-Nr. 6L..9..000 002→					0 265 232 246 ^B			
		RDK					0 265 232 249 ^B			
	09.06-11.09	74			RDK		0 265 232 246 ^B			
							0 265 232 252 ^F			
							0 265 234 700 ^T			
		RDK					0 265 232 249 ^B			
							0 265 232 255 ^F			
						0 265 234 703 ^T				
2.0	09.02-04.05	85				0 265 224 013 ^F				
						0 265 225 162 ^T				
04.03-05.05	85	Fg.-Nr. →6L..6..000 000				0 265 232 252 ^F				
05.04-05.05	85	Fg.-Nr. 6L..4..231 601→6L..6..000 000				0 265 234 119 ^T				
06.04-04.05	85	Fg.-Nr. 6L..4..231 601→				0 265 231 436 ^B				
06.04-05.06	85	Fg.-Nr. 6L..4..231 601→6L..9..000 001				0 265 231 436 ^B				
06.05-02.06	85	Fg.-Nr. 6L..6..000 001→	RDK			0 265 234 363 ^T				
	6L..6..523 398									
06.05-11.09	85	Fg.-Nr. 6L..6..000 001→	RDK			0 265 232 252 ^F				
	RDK					0 265 232 255 ^F				
						0 265 234 703 ^T				
03.06-11.09	85	Fg.-Nr. 6L..6..523 399→	RDK			0 265 234 700 ^T				
06.06-11.09	85	Fg.-Nr. 6L..9..000 002→	RDK			0 265 232 246 ^B				
RDK						0 265 232 249 ^B				
 1.2	10.02-04.04	47				0 265 005 252				
	11.04-06.06	47				0 265 005 692				
	05.06-11.09	51				0 265 005 692				
1.4	09.02-04.04	55				0 265 005 252				
	10.02-04.04	74	Fg.-Nr. →6L..4..232 600			0 265 005 252				
	05.04-11.06	74	Fg.-Nr. 6L..4..232 601→			0 265 005 692				
	05.04-12.07	55				0 265 005 692				
1.4, TDI	05.05-11.09	58/59/63				0 265 005 692				





























SEAT Cordoba [6L2]						
1.4 TDI	10.02-04.04	55	Fg.-Nr. →6L..4..232 600			0 265 005 252
	05.04-12.05	55	Fg.-Nr. 6L..4..232 601→			0 265 005 692
	05.05-11.09	51				0 265 005 692
1.6	04.03-04.04	74	Fg.-Nr. →6L..4..232 600			0 265 005 252
	05.04-11.09	74	Fg.-Nr. 6L..4..232 601→			0 265 005 692
	11.06-11.09	77				0 265 005 692
1.9 SDI	09.02-04.04	47	Fg.-Nr. →6L..4..232 600			0 265 005 252
	05.04-12.05	47	Fg.-Nr. 6L..4..232 601→			0 265 005 692
1.9 TDI	09.02-04.04	74/96	Fg.-Nr. →6L..4..232 600			0 265 005 252
	05.04-09.05	74/96	Fg.-Nr. 6L..4..232 601→			0 265 005 692
	05.05-11.09	74/96				0 265 005 692
2.0	09.02-04.04	85	Fg.-Nr. →6L..4..232 600			0 265 005 252
	05.04-11.09	85	Fg.-Nr. 6L..4..232 601→			0 265 005 692
1.2	10.02-04.04	47				0 265 005 303
	11.04-06.06	47				0 265 005 303
	05.06-11.09	51				0 265 005 303
1.4	09.02-11.09	51/55/58/ 59/63/74				0 265 005 303
1.4 TDI						
1.6	04.03-11.09	74/77				0 265 005 303
1.9 SDI, TDI	09.02-11.09	47/74/96				0 265 005 303
2.0	09.02-11.09	85				0 265 005 303

Exeo ST [3R5]









						
	1.6	06.09-09.10	75	JBH	TRW	0 986 481 046 25,4
	1.8, TSI	06.09→	88/110/118	JBH	TRW	0 986 481 046 25,4
	2.0 TDI, TSI	06.09→	88/105/125/147/155	JBH	TRW	0 986 481 046 25,4
	1.6	06.09-09.10	75	LLE		0 986 486 062 19,05
	1.8, TSI	06.09→	88/110/118	LLE		0 986 486 062 19,05
	2.0 TDI, TSI	06.09→	88/105/125/147/155	LLE		0 986 486 062 19,05
	1.6	06.09-09.10	75			0 986 486 583 22,2
	1.8	06.09-05.10	110			0 986 486 583 22,2
	1.8 TSI	05.10→	118	GSW		0 986 486 583 22,2
				GWT		0 986 486 583 22,2
		09.10→	88	GSW		0 986 486 583 22,2
				GWT		0 986 486 583 22,2
	2.0 TDI	06.09-12.11	88/105/125			0 986 486 583 22,2
		01.12→	88/105/ 125	GSW		0 986 486 583 22,2
	2.0 TSI	06.09→	147/155	GSW		0 986 486 583 22,2
				GWT		0 986 486 583 22,2
	1.6	06.09-09.10	75			0 265 234 338 ^T
	1.8, TSI	06.09-05.12	88/110/118			0 265 234 338 ^T
	2.0 TDI, TSI	06.09-05.12	88/105/125/147/155			0 265 234 338 ^T
	1.6	06.09-09.10	75			0 265 005 777
	1.8	06.09-05.10	110			0 265 005 777
	1.8 TSI	05.10→	118	GS		0 265 005 777
		09.10→	88	GS		0 265 005 777
	2.0 TDI, TSI	06.09→	88/105/125/147/155	GS		0 265 005 777
Exeo [3R2]						
						
	1.6	03.09-09.10	75	JBH	TRW	0 986 481 046 25,4
	1.8, TSI	12.08→	88/110/118	JBH	TRW	0 986 481 046 25,4
	2.0 TDI, TFSI, TSI	12.08→	88/105/125/147/155	JBH	TRW	0 986 481 046 25,4

		S							
	1.6	03.09-09.10	75			LLE	0 986 486 062	19,05	
	1.8, TSI	12.08→	88/110/118			LLE	0 986 486 062	19,05	
	2.0 TDI, TFSI, TSI	12.08→	88/105/125/147/155			LLE	0 986 486 062	19,05	
	1.6	03.09-09.10	75				0 986 486 583	22,2	
	1.8	12.08-05.10	110				0 986 486 583	22,2	
	1.8 TSI	05.10→	118			GSW	0 986 486 583	22,2	
		09.10→	88			GSW	0 986 486 583	22,2	
						GWT	0 986 486 583	22,2	
	2.0 TDI	12.08-12.11	88/105/125				0 986 486 583	22,2	
		01.12→	88/105/125			GSW	0 986 486 583	22,2	
						GWT	0 986 486 583	22,2	
	2.0 TFSI	03.09→	147/155			GSW	0 986 486 583	22,2	
	2.0 TSI					GWT	0 986 486 583	22,2	
	1.6	03.09-09.10	75				0 265 234 338 ^T		
	1.8, TSI	12.08-05.12	88/110/118				0 265 234 338 ^T		
	2.0 TDI, TFSI, TSI	12.08-05.12	88/105/125/147/155				0 265 234 338 ^T		
	1.6	03.09-09.10	75				0 265 005 777		
	1.8	12.08-05.10	110				0 265 005 777		
	1.8 TSI	05.10→	118			GS	0 265 005 777		
		09.10→	88			GS	0 265 005 777		
	2.0 TDI, TFSI, TSI	12.08→	88/105/125/147/155			GS	0 265 005 777		
Ibiza SC [6J1]									
									
	1.2	07.08-05.11	51	Get.-Nr. MG250			0 986 486 553	19,05	
				Get.-Nr. MQ200			0 986 486 554	19,05	
		06.09→	51				0 986 486 554	19,05	
		07.09→	44				0 986 486 554	19,05	
	1.2 TDI	05.10→	55				0 986 486 553	19,05	
	1.2 TSI	09.10→	63/77				0 986 486 554	19,05	
	1.4	07.08→	63				0 986 486 554	19,05	
	1.4 TDI	07.08-06.10	59	Get.-Nr. MG250			0 986 486 553	19,05	
				Get.-Nr. MQ200			0 986 486 554	19,05	
	1.4 TSI	10.13→	103				0 986 486 595	29	
	1.4 TSI	03.09-10.12	110/132	Get.-Nr. MG250			0 986 486 553	19,05	
	1.4 TSI Cupra			Get.-Nr. MQ200			0 986 486 554	19,05	
	1.6	07.08→	77	Get.-Nr. MG250			0 986 486 553	19,05	
				Get.-Nr. MQ200			0 986 486 554	19,05	
	1.6 GLP	05.11→	60				0 986 486 554	19,05	
	1.6 TDI	05.09→	66				0 986 486 553	19,05	
			77				0 986 486 553	19,05	
	1.9 TDI	02.08-06.10	66/77	Get.-Nr. MG250			0 986 486 553	19,05	
				Get.-Nr. MQ200			0 986 486 554	19,05	
	2.0 TDI	01.10→	105				0 986 486 595	29	
	1.2	07.08-05.11	51			TW	0 204 031 681 ^A		
							0 204 031 682 ^A		
	1.4, TDI, TSI, TSI Cupra	07.08-10.12	59/63/110/132			TW	0 204 031 681 ^A		
							0 204 031 682 ^A		
	1.6	07.08→	77			TW	0 204 031 681 ^A		
							0 204 031 682 ^A		
	1.9 TDI	02.08-06.10	66/77			TW	0 204 031 681 ^A		
							0 204 031 682 ^A		
	1.2	07.08-05.11	51				0 265 239 002 ^T		
	1.4, TDI	07.08-06.09	59/63			SSJ	0 265 239 002 ^T		
	1.4 TSI	03.09-06.09	110				0 265 239 002 ^T		

			S							
SEAT Ibiza SC [6J1]										
	1.4 TSI Cupra	03.09-06.09	132				SSJ	0 265 239 002 ^T		
	1.6, TDI	07.08-06.09	66/77					0 265 239 002 ^T		
	1.9 TDI	02.08-06.09	66/77				SSJ	0 265 239 002 ^T		
Ibiza ST [6J8]										
	1.2	05.10→	44/51					0 986 486 554	19,05	
	1.2 TDI	04.10→	55					0 986 486 553	19,05	
	1.2 TSI	09.10→	63/77					0 986 486 554	19,05	
	1.4	04.10→	63					0 986 486 554	19,05	
	1.4 TSI	02.12→	110	Get.-Nr. MG250				0 986 486 553	19,05	
				Get.-Nr. MQ200				0 986 486 554	19,05	
		10.13→	103					0 986 486 595	29	
	1.6 TDI	05.09→	66/77					0 986 486 553	19,05	
Ibiza [6J5]										
	1.2	03.08-05.11	51	Get.-Nr. MG250				0 986 486 553	19,05	
				Get.-Nr. MQ200				0 986 486 554	19,05	
		06.09→	51					0 986 486 554	19,05	
		07.09→	44					0 986 486 554	19,05	
	1.2 TDI	06.10→	55					0 986 486 553	19,05	
	1.2 TSI	09.10→	63/77					0 986 486 554	19,05	
	1.4	03.08→	63					0 986 486 554	19,05	
	1.4 TDI	08.08-06.10	59	Get.-Nr. MG250				0 986 486 553	19,05	
				Get.-Nr. MQ200				0 986 486 554	19,05	
	1.4 TSI	03.09→	110	Get.-Nr. MG250				0 986 486 553	19,05	
				Get.-Nr. MQ200				0 986 486 554	19,05	
		10.13→	103					0 986 486 595	29	
	1.6	05.08→	77	Get.-Nr. MG250				0 986 486 553	19,05	
				Get.-Nr. MQ200				0 986 486 554	19,05	
	1.6 GLP	05.11→	60					0 986 486 554	19,05	
	1.6 TDI	05.09→	66					0 986 486 553	19,05	
			77					0 986 486 553	19,05	
	1.9 TDI	02.08-06.10	66/77	Get.-Nr. MG250				0 986 486 553	19,05	
				Get.-Nr. MQ200				0 986 486 554	19,05	
	2.0 TDI	01.10→	105					0 986 486 595	29	
	1.2	03.08-05.11	51				TW	0 204 031 681 ^A		
								0 204 031 682 ^A		
	1.4, TDI, TSI	03.08-10.12	59/63/110				TW	0 204 031 681 ^A		
								0 204 031 682 ^A		
	1.6	05.08→	77				TW	0 204 031 681 ^A		
								0 204 031 682 ^A		
	1.9 TDI	02.08-06.10	66/77				TW	0 204 031 681 ^A		
								0 204 031 682 ^A		
	1.2	03.08-05.11	51					0 265 239 002 ^T		
	1.4, TDI	03.08-06.09	59/63				SSJ	0 265 239 002 ^T		
	1.4 TSI	03.09-06.09	110					0 265 239 002 ^T		
	1.6, TDI	05.08-06.09	66/77					0 265 239 002 ^T		
	1.9 TDI	02.08-06.09	66/77				SSJ	0 265 239 002 ^T		
Ibiza [6K1]										
	1.0	03.93-06.96	33				JBH	F 026 003 562	20,6	
		ABO 09.96-05.98	37	Fg.-Nr. →6K..X..008 000			JBH,RLE	F 026 003 562	20,6	
		09.96-10.99	37				JBH,LLE	F 026 003 562	20,6	
		06.98-10.99	37	Fg.-Nr. 6K..X..008 001→			RLE	0 204 123 520	20,6	

		S																	
1.0	ABO	05.99-05.02	37				JBH,LLE	F 026 003 563	22										
							RLE	0 204 123 521	22,22										
		10.99-05.02	51				JBH,LLE	F 026 003 563	22										
							RLE	0 204 123 521	22,22										
	ABS	09.96-05.02	37/51				JBH,LLE	0 986 480 987	23,81										
								0 986 481 016	22,2										
							JBH,RLE	0 986 480 869	22										
1.0 16V		10.99-10.04	52				JBH	F 026 003 563	22										
1.3		03.93-07.94	40				JBH	F 026 003 562	20,6										
1.4	ABO	09.93-12.97	44				JBH	F 026 003 562	20,6										
							05.97-05.98	74	Fg.-Nr. →6K..X..008 000	JBH,RLE	F 026 003 562	20,6							
							05.97-06.99	74		JBH,LLE	F 026 003 562	20,6							
							12.97-05.98	44	Fg.-Nr. →6K..X..008 000	JBH,RLE	F 026 003 562	20,6							
							12.97-10.99	44		JBH,LLE	F 026 003 562	20,6							
							01.98-05.98	40		JBH	F 026 003 562	20,6							
							06.98-06.99	74	Fg.-Nr. 6K..X..008 001→	RLE	0 204 123 520	20,6							
							06.98-10.99	44	Fg.-Nr. 6K..X..008 001→	RLE	0 204 123 520	20,6							
							05.99-05.02	44						JBH,LLE	F 026 003 563	22			
														RLE	0 204 123 521	22,22			
														JBH,LLE	F 026 003 563	22			
														RLE	0 204 123 521	22,22			
							09.99-05.02	74						JBH,LLE	F 026 003 563	22			
														RLE	0 204 123 521	22,22			
														JBH,LLE	F 026 003 563	22			
														RLE	0 204 123 521	22,22			
							10.95-12.95	44						JBH,LLE	0 986 480 987	23,81			
															0 986 481 016	22,2			
														JBH,RLE	0 986 480 869	22			
														12.95-05.02	44		JBH,LLE	0 986 480 987	23,81
			0 986 481 016	22,2															
			JBH,RLE	0 986 480 869	22														
05.97-05.02	55/74													JBH,LLE	0 986 480 987	23,81			
															0 986 481 016	22,2			
															JBH,RLE	0 986 480 869	22		
															0 986 480 987	23,81			
01.98-05.98	40													JBH,LLE	0 986 480 987	23,81			
															0 986 481 016	22,2			
								JBH,RLE	0 986 480 869	22									
								0 986 480 869	22										
1.6		03.93-07.94	55				JBH	F 026 003 562	20,6										
		05.95-09.99	76				JBH	F 026 003 562	20,6										
		10.99-10.04	76				JBH	F 026 003 563	22										
ABO	05.94-05.98	55	Fg.-Nr. →6K..X..008 000				JBH,RLE	F 026 003 562	20,6										
							05.94-05.02	55		JBH,LLE	F 026 003 562	20,6							
							12.95-05.98	74	Fg.-Nr. →6K..X..008 000	JBH,RLE	F 026 003 563	22							
							12.95-05.02	74		JBH,LLE	F 026 003 563	22							
							06.98-10.99	74	Fg.-Nr. 6K..X..008 001→	RLE	0 204 123 521	22,22							
							06.98-05.02	55	Fg.-Nr. 6K..X..008 001→	RLE	0 204 123 520	20,6							
							05.99-05.02	74		RLE	0 204 123 521	22,22							
							10.95-08.99	55						JBH,LLE	0 986 480 987	23,81			
															0 986 481 016	22,2			
														JBH,RLE	0 986 480 869	22			
12.95-05.02	74		JBH,LLE	0 986 480 987	23,81														
							0 986 481 016	22,2											
							JBH,RLE	0 986 480 869	22										
03.97-05.02	55						JBH,LLE	0 986 480 987	23,81										
								0 986 481 016	22,2										
								JBH,RLE	0 986 480 869	22									
								0 986 480 869	22										
1.8	ABO	03.93-07.94	66				JBH	F 026 003 562	20,6										
							09.93-06.96	95		JBH,RLE	F 026 003 563	22							
							07.94-05.98	66	Fg.-Nr. →6K..X..008 000	JBH,RLE	F 026 003 562	20,6							
							07.94-10.99	66		JBH,LLE	F 026 003 562	20,6							
							06.98-10.99	66	Fg.-Nr. 6K..X..008 001→	RLE	0 204 123 520	20,6							
							09.93-09.95	95						JBH,LLE	0 986 480 878	23,8			
														10.95-06.96	95	Fg.-Nr. 6K..TR069 487→	JBH,LLE	0 986 480 987	23,81
																		0 986 481 016	22,2
							JBH,RLE	0 986 480 869	22										

		S												
	SEAT Ibiza [6K1]													
1.8	ABS	10.95-10.99	66	Fg.-Nr. 6K..TR069 487→	JBH,LLE	0 986 480 987	23,81							
						0 986 481 016	22,2							
						JBH,RLE	0 986 480 869	22						
1.8 T Cupra		10.99-05.02	115		RLE	0 204 055 389								
	ASR	10.99-05.02	115		JBH,LLE	0 986 480 987	23,81							
1.9 D	ABS	10.95-10.99	47-50	Fg.-Nr. 6K..TR069 487→	JBH,LLE	0 986 480 987	23,81							
						0 986 481 016	22,2							
						JBH,RLE	0 986 480 869	22						
1.9 D	ABO	03.93-05.98	47-50	Fg.-Nr. →6K..X..008 000	JBH,RLE	F 026 003 562	20,6							
1.9 SDI		03.93-10.99	47-50		JBH,LLE	F 026 003 562	20,6							
		06.98-10.99	47-50	Fg.-Nr. 6K..X..008 001→	RLE	0 204 123 520	20,6							
1.9 SDI	ABO	05.99-05.02	50		JBH,LLE	F 026 003 563	22							
						RLE	0 204 123 521	22,22						
	ABS	12.95-10.99	47		JBH,LLE	0 986 480 987	23,81							
						0 986 481 016	22,2							
	JBH,RLE	0 986 480 869	22		JBH,LLE	0 986 480 987	23,81							
						0 986 481 016	22,2							
	05.99-05.02	50		JBH,LLE	0 986 480 987	23,81								
					0 986 481 016	22,2								
	JBH,RLE	0 986 480 869	22		JBH,LLE	0 986 480 987	23,81							
						0 986 481 016	22,2							
1.9 TD	ABO	03.93-08.97	55		JBH	F 026 003 562	20,6							
						ABS	10.95-08.97	55	Fg.-Nr. 6K..TR069 487→	JBH,LLE	0 986 480 987	23,81		
											0 986 481 016	22,2		
JBH,RLE	0 986 480 869	22		JBH,LLE	0 986 480 987	23,81								
					0 986 481 016	22,2								
1.9 TDI	ABO	07.96-12.96	66		JBH	F 026 003 563	22							
						12.96-05.98	66	Fg.-Nr. →6K..X..008 000	JBH,RLE	F 026 003 563	22			
	12.96-05.02	66		JBH,LLE	F 026 003 563					22				
					03.97-05.98	81	Fg.-Nr. →6K..X..008 000	JBH,RLE	F 026 003 563	22				
	03.97-05.02	81		JBH,LLE					F 026 003 563	22				
					06.98-06.99	66	Fg.-Nr. 6K..X..008 001→	RLE	0 204 123 521	22,22				
	81	Fg.-Nr. 6K..X..008 001→	RLE	0 204 123 521					22,22					
				05.99-05.02	66		RLE	0 204 123 521	22,22					
	81		RLE					0 204 123 521	22,22					
				ABS	07.96-06.99	66		JBH,LLE	0 986 480 987	23,81				
	0 986 481 016	22,2												
	JBH,RLE	0 986 480 869	22		JBH,LLE	0 986 480 987	23,81							
						0 986 481 016	22,2							
	03.97-06.99	81		JBH,LLE	0 986 480 987	23,81								
					0 986 481 016	22,2								
JBH,RLE	0 986 480 869	22		RLE	0 204 055 389									
					RLE	0 204 055 389								
ASR	05.99-05.02	81		JBH,LLE	0 986 480 987	23,81								
					0 986 481 016	22,2								
2.0	ABO	03.93-04.96	85		JBH,RLE	F 026 003 563	22							
						04.96-03.97	85	Fg.-Nr. →6K..V..150 000	JBH,RLE	F 026 003 563	22			
										04.96-10.99	85		JBH,LLE	F 026 003 563
	06.98-10.99	85	Fg.-Nr. 6K..X..008 001→	RLE	0 204 123 521	22,22								
					ABS	03.93-09.95	85	Fg.-Nr. →6K..TR069 486	JBH,LLE	0 986 480 878	23,8			
	10.95-04.96	85	Fg.-Nr. 6K..TR069 487→	JBH,LLE						0 986 480 987	23,81			
					0 986 481 016	22,2								
	JBH,RLE	0 986 480 869	22		JBH,LLE	0 986 480 987	23,81							
						0 986 481 016	22,2							
	04.96-10.99	85		JBH,LLE	0 986 480 987	23,81								
					0 986 481 016	22,2								
	JBH,RLE	0 986 480 869	22		JBH,LLE	0 986 480 987	23,81							
0 986 481 016						22,2								
1.0		03.93-06.96	33		1AB,RLE	0 204 125 264								
					1AG,LLE	0 204 125 262								
					1AG,RLE	0 204 125 263								
					1AL,RLE	0 204 125 517								

		S								
1.0	ABO	09.96-10.99	37	1AB,RLE	0 204 125 264					
				1AG,LLE	0 204 125 262					
				1AG,RLE	0 204 125 263					
				1AL,RLE	0 204 125 517					
		05.99-05.02	37	LLE	0 204 125 262					
		10.99-05.02	51	RLE	0 204 125 263					
				LLE	0 204 125 262					
				RLE	0 204 125 263					
1.3	ABO	03.93-07.94	40	1AB,RLE	0 204 125 264					
				1AG,LLE	0 204 125 262					
				1AG,RLE	0 204 125 263					
				1AL,RLE	0 204 125 517					
1.4	ABO	09.93-10.99	44	1AB,RLE	0 204 125 264					
				1AG,LLE	0 204 125 262					
				1AG,RLE	0 204 125 263					
				1AL,RLE	0 204 125 517					
			05.97-06.99	74	1AB,RLE	0 204 125 264				
					1AG,LLE	0 204 125 262				
					1AG,RLE	0 204 125 263				
					1AL,RLE	0 204 125 517				
			01.98-05.98	40	1AB,RLE	0 204 125 264				
					1AG,LLE	0 204 125 262				
					1AG,RLE	0 204 125 263				
					1AL,RLE	0 204 125 517				
			05.99-05.02	44	LLE	0 204 125 262				
				55	RLE	0 204 125 263				
					LLE	0 204 125 262				
					RLE	0 204 125 263				
		09.99-05.02	74	LLE	0 204 125 262					
				RLE	0 204 125 263					
1.6	ABO	03.93-07.94	55	1AB,RLE	0 204 125 264					
				1AG,LLE	0 204 125 262					
				1AG,RLE	0 204 125 263					
				1AL,RLE	0 204 125 517					
			05.94-05.02	55	1AB,RLE	0 204 125 264				
					1AG,LLE	0 204 125 262				
					1AG,RLE	0 204 125 263				
					1AL,RLE	0 204 125 517				
			12.95-10.99	74	1AB,RLE	0 204 125 264				
					1AG,LLE	0 204 125 262				
					1AG,RLE	0 204 125 263				
					1AL,RLE	0 204 125 517				
		05.99-05.02	74	LLE	0 204 125 262					
				RLE	0 204 125 263					
1.8	ABO	03.93-10.99	66/95	1AB,RLE	0 204 125 264					
				1AG,LLE	0 204 125 262					
				1AG,RLE	0 204 125 263					
				1AL,RLE	0 204 125 517					
1.8T Cupra	ABO	10.99-05.02	115	LLE	0 204 125 262					
				RLE	0 204 125 263					
1.9D 1.9SDI	ABO	03.93-10.99	47-50	1AB,RLE	0 204 125 264					
				1AG,LLE	0 204 125 262					
				1AG,RLE	0 204 125 263					
				1AL,RLE	0 204 125 517					
1.9SDI	ABO	05.99-05.02	50	LLE	0 204 125 262					
				RLE	0 204 125 263					
1.9TD	ABO	03.93-08.97	55	1AB,RLE	0 204 125 264					
				1AG,LLE	0 204 125 262					
				1AG,RLE	0 204 125 263					
				1AL,RLE	0 204 125 517					





SEAT Ibiza [6K1]

1.9 TDI	ABO	07.96-06.99	66/81	1AB,RLE	0 204 125 264			
				1AG,LLE	0 204 125 262			
				1AG,RLE	0 204 125 263			
				1AL,RLE	0 204 125 517			
				LLE	0 204 125 262			
		05.99-05.02	66/81	RLE	0 204 125 263			
		ABS	09.00-05.02	66/81	Fg.-Nr. 6K..1..111 610→	RLE	0 204 055 380	
	2.0	ABO	03.93-10.99	85	1AB,RLE	0 204 125 264		
					1AG,LLE	0 204 125 262		
					1AG,RLE	0 204 125 263		
1AL,RLE					0 204 125 517			
LLE					0 204 125 262			
		06.96-10.99	110	1AB,RLE	0 204 125 264			
				1AG,LLE	0 204 125 262			
				1AG,RLE	0 204 125 263			
				1AL,RLE	0 204 125 517			
		ABS	06.96-10.99	110	RLE	0 204 125 263		











1.6	05.99-05.02	74	LLE	0 986 486 109	15,8	
			1.8 T Cupra	10.99-05.02	115	LLE
	1.9 SDI	12.95-10.99	47	LLE	0 986 486 038	19
				05.99-05.02	50	LLE
	1.9 TDI	07.96-06.99	66/81	LLE	0 986 486 038	19
				05.99-05.02	66/81	LLE

1.6	05.99-05.02	74	LLE	0 986 486 542	23,81	
			1.8 T Cupra	10.99-05.02	115	0 986 486 538
	1.9 SDI	12.95-10.99	47	LLE	0 986 486 537	23,8
				05.99-05.02	50	0 986 486 542
	1.9 TDI	07.96-06.99	66/81	LLE	0 986 486 537	23,8
				05.99-05.02	66/81	0 986 486 538

1.0	05.99-05.02	37/51		0 204 131 697 ^A		
			1.4	09.93-05.02	40/44/55/74	0 204 131 697 ^A
	1.6	03.93-05.02	55/74		0 204 131 697 ^A	
				1.8, T Cupra	03.93-05.02	66/95/115
	1.9 SDI	05.99-05.02	50		0 204 131 697 ^A	
				1.9 TDI	05.99-05.02	66/81
	2.0	03.93-10.99	85/110		0 204 131 697 ^A	









Ibiza [6L1]

1.2	ABO	11.01-11.09	44/47/51	JBH	0 986 480 850	20,6				
				ABS	11.01-06.06	47	JBH	0 986 480 820	20,6	
							05.06-07.06	51	Fg.-Nr. →6L..7..048 489	JBH
	1.4	ABS	09.01-05.02	74	JBH	0 986 480 820	20,6			
					01.02-04.04	55	JBH	0 986 480 820	20,6	
					04.02-05.05	74	Fg.-Nr. →6L..6..000 000	JBH	0 986 480 820	20,6
			05.04-12.07	55	Fg.-Nr. →6L..7..048 489	JBH	0 986 480 820	20,6		
			06.05-07.06	74	Fg.-Nr. 6L..6..000 001→ 6L..7..048 489	JBH	0 986 480 820	20,6		
			05.06-07.06	63	Fg.-Nr. →6L..7..048 489	JBH	0 986 480 820	20,6		
	1.4	ABO	09.01-11.09	51/55/59/ 63/74	JBH	0 986 480 850	20,6			
	1.4 TDI	ABS	05.02-12.05	55	JBH	0 986 480 820	20,6			
					05.05-05.05	51	Fg.-Nr. →6L..6..000 000	JBH	0 986 480 820	20,6
							59	Fg.-Nr. →6L..6..000 000	JBH	0 986 480 820
			06.05-07.06	51	Fg.-Nr. 6L..6..000 001→ 6L..7..048 489	JBH	0 986 480 820	20,6		
				59	Fg.-Nr. 6L..6..000 001→ 6L..7..048 489	JBH	0 986 480 820	20,6		
			06.06-07.06	59	Fg.-Nr. →6L..7..048 489	JBH	0 986 480 820	20,6		

		S								
1.6	ABO	04.03-11.09	74/77				JBH	0 986 480 850	20,6	
	ABS	04.03-05.05	74	Fg.-Nr. →6L..6..000 000			JBH	0 986 480 820	20,6	
		06.05-07.06	74	Fg.-Nr. 6L..6..000 001→ 6L..7..048 489			JBH	0 986 480 820	20,6	
1.8 T	ABO	12.03-11.09	110				JBH	0 986 480 850	20,6	
	ABS	12.03-05.05	110	Fg.-Nr. →6L..6..000 000			JBH	0 986 480 820	20,6	
		06.05-07.06	110	Fg.-Nr. 6L..6..000 001→ 6L..7..048 489			JBH	0 986 480 820	20,6	
1.8 T Cupra R		05.04-02.08	132	Fg.-Nr. →6L..7..048 489			JBH	0 986 480 820	20,6	
1.9 SDI	ABS	01.02-12.05	47				JBH	0 986 480 820	20,6	
1.9 SDI, TDI, TDI Cupra R	ABO	09.01-11.09	47/74/96/118				JBH	0 986 480 850	20,6	
1.9 TDI	ABS	09.01-09.05	74/96				JBH	0 986 480 820	20,6	
		06.05-07.06	74/96	Fg.-Nr. 6L..6..000 001→ 6L..7..048 489			JBH	0 986 480 820	20,6	
1.9 TDI Cupra R		03.04-11.05	118				JBH	0 986 480 820	20,6	
	ABS	11.05-07.06	118	Fg.-Nr. →6L..7..048 489			JBH	0 986 480 820	20,6	
2.0	ABO	07.02-11.09	85				JBH	0 986 480 850	20,6	
	ABS	07.02-04.04	85				JBH	0 986 480 820	20,6	
		04.03-05.05	85	Fg.-Nr. →6L..6..000 000			JBH	0 986 480 820	20,6	
		06.05-07.06	85	Fg.-Nr. 6L..6..000 001→ 6L..7..048 489			JBH	0 986 480 820	20,6	
	1.2	11.01-11.09	44/47/51					0 986 486 060	15,87	
	1.4, TDI	09.01-11.09	51/55/59/63/74					0 986 486 060	15,87	
	1.6	04.03-11.09	74/77					0 986 486 060	15,87	
	1.8 T, T Cupra R	12.03-11.09	110/132					0 986 486 060	15,87	
	1.9 SDI, TDI, TDI Cupra R	09.01-11.09	47/74/96/118					0 986 486 060	15,87	
	2.0	07.02-11.09	85					0 986 486 060	15,87	
	1.2	11.01-11.09	44/47/51	PR-Code 0EJ				0 986 486 553	19,05	
				PR-Code OEM				0 986 486 554	19,05	
	1.4	09.01-11.09	51/55/59/	PR-Code 0EJ				0 986 486 553	19,05	
	1.4 TDI		63/74	PR-Code OEM				0 986 486 554	19,05	
	1.6	04.03-11.09	74/77	PR-Code 0EJ				0 986 486 553	19,05	
				PR-Code OEM			0 986 486 554	19,05		
	1.8 T	12.03-11.09	110	PR-Code 0EJ				0 986 486 553	19,05	
				PR-Code OEM			0 986 486 554	19,05		
	1.8 T Cupra R	05.04-02.08	132					0 986 486 553	19,05	
				PR-Code OEM			0 986 486 554	19,05		
	1.9 SDI	09.01-11.09	47/74	PR-Code 0EJ				0 986 486 553	19,05	
	1.9 TDI			PR-Code OEM				0 986 486 554	19,05	
	1.9 TDI, TDI Cupra R	11.01-11.09	96/118					0 986 486 595	29	
	2.0	07.02-11.09	85	PR-Code 0EJ				0 986 486 553	19,05	
PR-Code OEM						0 986 486 554	19,05			
	1.2	11.01-06.06	47					0 204 131 682 ^A		
		05.06-10.06	51	Fg.-Nr. →6L..7..088 000				0 204 131 682 ^A		
	1.2	11.06-11.09	51	Fg.-Nr. 6L..7..088 001→	AG			0 204 031 681 ^A		
					GS			0 204 031 682 ^A		
	1.2	06.07-05.08	44		AG			0 204 031 681 ^A		
					GS			0 204 031 682 ^A		
	1.4	09.01-05.02	74					0 204 131 682 ^A		
								0 204 131 682 ^A		
		04.02-10.06	74	Fg.-Nr. →6L..7..088 000					0 204 131 682 ^A	
									0 204 131 682 ^A	
05.04-10.06		55	Fg.-Nr. →6L..7..088 000					0 204 131 682 ^A		
								0 204 131 682 ^A		
05.06-10.06		63	Fg.-Nr. →6L..7..088 000					0 204 131 682 ^A		
								0 204 131 682 ^A		
11.06-12.07		55	Fg.-Nr. 6L..7..088 001→		AG			0 204 031 681 ^A		
					GS			0 204 031 682 ^A		
11.06-11.09	63	Fg.-Nr. 6L..7..088 001→		AG			0 204 031 681 ^A			
				GS			0 204 031 682 ^A			
11.06-11.09	74	Fg.-Nr. 6L..7..088 001→		AG			0 204 031 681 ^A			
				GS			0 204 031 682 ^A			

		S							
SEAT Ibiza [6L1]									
1.4 TDI	05.02-12.05	55							0 204 031 681 ^A
	05.05-11.09	51							0 204 031 681 ^A
		59							0 204 031 681 ^A
1.6	04.03-10.06	74	Fg.-Nr. →6L..7..088 000						0 204 131 682 ^A
	11.06-11.09	74	Fg.-Nr. 6L..7..088 001→				AG		0 204 031 681 ^A
								GS	0 204 031 682 ^A
		77					AG	0 204 031 681 ^A	
								GS	0 204 031 682 ^A
1.8 T	12.03-10.06	110	Fg.-Nr. →6L..7..088 000						0 204 131 682 ^A
	11.06-11.09	110	Fg.-Nr. 6L..7..088 001→				AG	0 204 031 681 ^A	
									0 204 031 682 ^A
1.9 SDI, TDI, TDI Cupra R	09.01-11.09	47/74/96/118							0 204 031 681 ^A
2.0	07.02-04.04	85							0 204 131 682 ^A
	04.03-10.06	85	Fg.-Nr. →6L..7..088 000						0 204 131 682 ^A
	11.06-11.09	85	Fg.-Nr. 6L..7..088 001→				AG		0 204 031 681 ^A
								GS	0 204 031 682 ^A
1.2	11.01-04.05	47							0 265 224 013 ^F
									0 265 225 162 ^T
	11.04-05.05	47	Fg.-Nr. →6L..6..000 000						0 265 232 252 ^F
									0 265 234 119 ^T
	11.04-05.06	47	Fg.-Nr. →6L..9..000 001						0 265 231 436 ^B
	06.05-02.06	47	Fg.-Nr. 6L..6..000 001→					RDK	0 265 234 363 ^T
				6L..6..523 398					
	06.05-06.06	47	Fg.-Nr. 6L..6..000 001→				RDK	0 265 232 252 ^F	
							RDK	0 265 232 255 ^F	
									0 265 234 703 ^T
	03.06-06.06	47	Fg.-Nr. 6L..6..523 399→				RDK	0 265 234 700 ^T	
	05.06-11.09	51						RDK	0 265 232 246 ^B
									0 265 232 252 ^F
									0 265 234 700 ^T
								RDK	0 265 232 249 ^B
									0 265 232 255 ^F
									0 265 234 703 ^T
	06.06-06.06	47	Fg.-Nr. 6L..9..000 002→				RDK	0 265 232 246 ^B	
							RDK	0 265 232 249 ^B	
	06.07-05.08	44						RDK	0 265 232 246 ^B
									0 265 232 252 ^F
									0 265 234 700 ^T
							RDK	0 265 232 249 ^B	
								0 265 232 255 ^F	
								0 265 234 703 ^T	
1.4	09.01-05.02	74							0 265 224 013 ^F
									0 265 225 162 ^T
	01.02-04.04	55							0 265 224 013 ^F
									0 265 225 162 ^T
	04.02-04.04	74	Fg.-Nr. →6L..4..231 600						0 265 225 162 ^T
	04.02-05.05	74	Fg.-Nr. →6L..6..000 000						0 265 232 252 ^F
	05.04-05.05	55	Fg.-Nr. →6L..6..000 000						0 265 232 252 ^F
		74	Fg.-Nr. 6L..4..231 601→6L..6..000 000						0 265 234 119 ^T
	06.04-05.06	55	Fg.-Nr. 6L..4..231 601→6L..9..000 001						0 265 231 436 ^B
		74	Fg.-Nr. 6L..4..231 601→6L..9..000 001						0 265 231 436 ^B
	06.05-02.06	55	Fg.-Nr. 6L..6..000 001→					RDK	0 265 234 363 ^T
				6L..6..523 398					
		74	Fg.-Nr. 6L..6..000 001→					RDK	0 265 234 363 ^T
									6L..6..523 398
	06.05-12.07	55	Fg.-Nr. 6L..6..000 001→					RDK	0 265 232 252 ^F
							RDK	0 265 234 703 ^T	
06.05-11.09	74	Fg.-Nr. 6L..6..000 001→					RDK	0 265 232 252 ^F	
							RDK	0 265 232 255 ^F	
								0 265 234 703 ^T	
03.06-12.07	55	Fg.-Nr. 6L..6..523 399→					RDK	0 265 234 700 ^T	
03.06-11.09	74	Fg.-Nr. 6L..6..523 399→					RDK	0 265 234 700 ^T	



		S								
1.4	05.06-11.09	63				RDK	0 265 232 246 ^B			
							0 265 232 252 ^F			
							0 265 234 700 ^T			
							RDK	0 265 232 249 ^B		
							0 265 232 255 ^F			
							0 265 234 703 ^T			
	06.06-12.07	55	Fg.-Nr. 6L..9..000 002→			RDK	0 265 232 246 ^B			
						RDK	0 265 232 249 ^B			
	06.06-11.09	74	Fg.-Nr. 6L..9..000 002→			RDK	0 265 232 246 ^B			
						RDK	0 265 232 249 ^B			
1.4	05.02-05.05	55	Fg.-Nr. →6L..6..000 000				0 265 234 119 ^T			
1.4 TDI	06.05-12.07	55	Fg.-Nr. 6L..6..000 001→			RDK	0 265 232 255 ^F			
1.4 TDI	05.02-04.04	55	Fg.-Nr. →6L..4..231 600				0 265 225 162 ^T			
							0 265 232 252 ^F			
	05.02-05.05	55	Fg.-Nr. →6L..6..000 000					0 265 231 436 ^B		
								0 265 232 252 ^F		
	06.04-12.05	55	Fg.-Nr. 6L..4..231 601→					0 265 231 436 ^B		
								0 265 232 252 ^F		
	05.05-05.05	51	Fg.-Nr. →6L..6..000 000					0 265 232 252 ^F		
								0 265 232 252 ^F		
	05.05-05.06	51	Fg.-Nr. →6L..9..000 001					0 265 231 436 ^B		
								0 265 231 436 ^B		
	06.05-12.05	55	Fg.-Nr. 6L..6..000 001→				RDK	0 265 232 252 ^F		
							RDK	0 265 234 363 ^T		
		06.05-02.06	51	Fg.-Nr. 6L..6..000 001→ 6L..6..523 398			RDK	0 265 234 363 ^T		
							RDK	0 265 234 363 ^T		
		06.05-11.09	51	Fg.-Nr. 6L..6..000 001→			RDK	0 265 232 252 ^F		
RDK							0 265 232 255 ^F			
		59	Fg.-Nr. 6L..6..000 001→			RDK	0 265 234 703 ^T			
						RDK	0 265 232 252 ^F			
		59	Fg.-Nr. 6L..6..000 001→			RDK	0 265 232 255 ^F			
						RDK	0 265 234 703 ^T			
	03.06-11.09	51	Fg.-Nr. 6L..6..523 399→			RDK	0 265 234 700 ^T			
						RDK	0 265 234 700 ^T			
	06.06-11.09	51	Fg.-Nr. 6L..9..000 002→			RDK	0 265 232 246 ^B			
						RDK	0 265 232 249 ^B			
		59	Fg.-Nr. 6L..9..000 002→			RDK	0 265 232 246 ^B			
						RDK	0 265 232 252 ^F			
		59	Fg.-Nr. 6L..9..000 002→			RDK	0 265 234 700 ^T			
						RDK	0 265 232 249 ^B			
		59	Fg.-Nr. 6L..9..000 002→			RDK	0 265 232 255 ^F			
						RDK	0 265 234 703 ^T			
1.6	04.03-04.04	74	Fg.-Nr. →6L..4..231 600				0 265 225 162 ^T			
							0 265 232 252 ^F			
	04.03-05.05	74	Fg.-Nr. →6L..6..000 000					0 265 234 119 ^T		
								0 265 231 436 ^B		
	06.04-05.06	74	Fg.-Nr. 6L..4..231 601→6L..9..000 001					0 265 231 436 ^B		
	06.05-02.06	74	Fg.-Nr. 6L..6..000 001→ 6L..6..523 398					0 265 234 363 ^T		
								0 265 234 363 ^T		
	06.05-11.09	74	Fg.-Nr. 6L..6..000 001→				RDK	0 265 232 252 ^F		
							RDK	0 265 232 255 ^F		
			74	Fg.-Nr. 6L..6..000 001→			RDK	0 265 234 703 ^T		
							RDK	0 265 232 252 ^F		
		03.06-11.09	74	Fg.-Nr. 6L..6..523 399→			RDK	0 265 234 700 ^T		
							RDK	0 265 234 700 ^T		
	06.06-11.09	74	Fg.-Nr. 6L..9..000 002→				RDK	0 265 232 246 ^B		
							RDK	0 265 232 249 ^B		
	11.06-11.09	77	Fg.-Nr. 6L..9..000 002→			RDK	0 265 232 246 ^B			
						RDK	0 265 232 252 ^F			
		77	Fg.-Nr. 6L..9..000 002→			RDK	0 265 234 700 ^T			
						RDK	0 265 232 249 ^B			
		77	Fg.-Nr. 6L..9..000 002→			RDK	0 265 232 255 ^F			
						RDK	0 265 234 703 ^T			



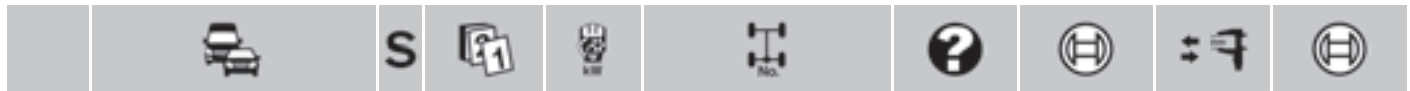









SEAT Ibiza [6L1]

1.8 T	12.03-04.04	110	Fg.-Nr. →6L..4..231 600		0 265 225 162 ^T
	12.03-05.05	110	Fg.-Nr. →6L..6..000 000		0 265 232 252 ^F 0 265 234 119 ^T
12.03-05.08	110			RDK	0 265 232 252 ^F
				RDK	0 265 232 255 ^F
06.04-05.06	110	Fg.-Nr. 6L..4..231 601→6L..9..000 001			0 265 231 436 ^B
06.05-02.06	110	Fg.-Nr. 6L..6..000 001→ 6L..6..523 398	RDK		0 265 234 363 ^T
06.05-11.09	110	Fg.-Nr. 6L..6..000 001→	RDK	0 265 232 252 ^F	
			RDK	0 265 232 255 ^F 0 265 234 703 ^T	
03.06-11.09	110	Fg.-Nr. 6L..6..523 399→	RDK		0 265 234 700 ^T
06.06-11.09	110	Fg.-Nr. 6L..9..000 002→	RDK	0 265 232 246 ^B	
			RDK	0 265 232 249 ^B	
1.8 T Cupra R	05.04-05.05	132	Fg.-Nr. →6L..6..000 000		0 265 232 252 ^F 0 265 234 119 ^T
	06.04-05.06	132	Fg.-Nr. 6L..4..231 601→6L..9..000 001		0 265 231 436 ^B
04.05-05.06	132	Fg.-Nr. →6L..9..000 001			0 265 231 436 ^B
06.05-02.06	132	Fg.-Nr. 6L..6..000 001→ 6L..6..523 398	RDK		0 265 234 363 ^T
06.05-02.08	132	Fg.-Nr. 6L..6..000 001→	RDK	0 265 232 252 ^F	
			RDK	0 265 232 255 ^F 0 265 234 703 ^T	
03.06-02.08	132	Fg.-Nr. 6L..6..523 399→	RDK		0 265 234 700 ^T
06.06-02.08	132	Fg.-Nr. 6L..9..000 002→	RDK	0 265 232 246 ^B	
			RDK	0 265 232 249 ^B	
1.9 SDI	01.02-04.04	47	Fg.-Nr. →6L..4..231 600		0 265 225 162 ^T
	01.02-05.05	47	Fg.-Nr. →6L..6..000 000		0 265 232 252 ^F 0 265 234 119 ^T
06.04-12.05	47	Fg.-Nr. 6L..4..231 601→			0 265 231 436 ^B
06.05-12.05	47	Fg.-Nr. 6L..6..000 001→	RDK	0 265 232 252 ^F	
			RDK	0 265 234 363 ^T 0 265 232 255 ^F 0 265 234 703 ^T	
1.9 TDI	09.01-04.04	74	Fg.-Nr. →6L..4..231 600		0 265 225 162 ^T
	09.01-05.05	74			0 265 224 013 ^F
11.01-04.04	96	Fg.-Nr. →6L..4..231 600			0 265 225 162 ^T
11.01-05.05	96	Fg.-Nr. →6L..6..000 000			0 265 232 252 ^F 0 265 234 119 ^T
05.04-05.05	74	Fg.-Nr. 6L..4..231 601→			0 265 234 119 ^T
06.04-05.05	74	Fg.-Nr. 6L..4..231 601→			0 265 231 436 ^B
06.04-09.05	96	Fg.-Nr. 6L..4..231 601→			0 265 231 436 ^B
05.05-05.05	74	Fg.-Nr. →6L..6..000 000		0 265 232 252 ^F	
				0 265 234 119 ^T	
05.05-05.06	74	Fg.-Nr. →6L..9..000 001			0 265 231 436 ^B
	96	Fg.-Nr. →6L..9..000 001			0 265 231 436 ^B
06.05-09.05	96	Fg.-Nr. 6L..6..000 001→	RDK		0 265 234 363 ^T
06.05-02.06	74	Fg.-Nr. 6L..6..000 001→ 6L..6..523 398	RDK		0 265 234 363 ^T
	96	Fg.-Nr. 6L..6..000 001→ 6L..6..523 398	RDK	0 265 234 363 ^T	
06.05-11.09	74	Fg.-Nr. 6L..6..000 001→	RDK	0 265 232 252 ^F	
			RDK	0 265 232 255 ^F 0 265 234 703 ^T	
06.05-11.09	96	Fg.-Nr. 6L..6..000 001→	RDK	0 265 232 252 ^F	
			RDK	0 265 232 255 ^F 0 265 234 703 ^T	
03.06-11.09	74	Fg.-Nr. 6L..6..523 399→	RDK		0 265 234 700 ^T
	96	Fg.-Nr. 6L..6..523 399→	RDK		0 265 234 700 ^T
06.06-11.09	74	Fg.-Nr. 6L..9..000 002→	RDK	0 265 232 246 ^B	
			RDK	0 265 232 249 ^B	
06.06-11.09	96	Fg.-Nr. 6L..9..000 002→	RDK	0 265 232 246 ^B	
			RDK	0 265 232 249 ^B	



		S								
1.9 TDI	09.06-11.09	74				RDK	0 265 232 246 ^B			
							0 265 232 252 ^F			
							0 265 234 700 ^T			
							0 265 232 249 ^B			
							0 265 232 255 ^F			
1.9 TDI Cupra R	03.04-04.04	118	Fg.-Nr. →6L..4..231 600				0 265 225 162 ^T			
							0 265 232 252 ^F			
	03.04-05.05	118	Fg.-Nr. →6L..6..000 000					0 265 234 119 ^T		
	06.04-11.05	118	Fg.-Nr. 6L..4..231 601→				0 265 231 436 ^B			
	06.05-11.05	118	Fg.-Nr. 6L..6..000 001→			RDK	0 265 232 252 ^F			
						RDK	0 265 234 363 ^T			
								0 265 232 255 ^F		
								0 265 234 703 ^T		
	11.05-02.06	118	Fg.-Nr. →6L..6..523 398			RDK	0 265 234 363 ^T			
	11.05-05.06	118	Fg.-Nr. →6L..9..000 001				0 265 231 436 ^B			
11.05-02.08	118				RDK	0 265 232 252 ^F				
					RDK	0 265 232 255 ^F				
							0 265 234 703 ^T			
03.06-02.08	118	Fg.-Nr. 6L..6..523 399→			RDK	0 265 234 700 ^T				
06.06-02.08	118	Fg.-Nr. 6L..9..000 002→			RDK	0 265 232 246 ^B				
					RDK	0 265 232 249 ^B				
2.0	07.02-04.04	85					0 265 224 013 ^F			
							0 265 225 162 ^T			
	04.03-05.05	85	Fg.-Nr. →6L..6..000 000					0 265 232 252 ^F		
								0 265 234 119 ^T		
	06.04-05.06	85	Fg.-Nr. 6L..4..231 601→6L..9..000 001				0 265 231 436 ^B			
	06.05-02.06	85	Fg.-Nr. 6L..6..000 001→ 6L..6..523 398			RDK	0 265 234 363 ^T			
	06.05-11.09	85	Fg.-Nr. 6L..6..000 001→			RDK	0 265 232 252 ^F			
						RDK	0 265 232 255 ^F			
								0 265 234 703 ^T		
03.06-11.09	85	Fg.-Nr. 6L..6..523 399→			RDK	0 265 234 700 ^T				
06.06-11.09	85	Fg.-Nr. 6L..9..000 002→			RDK	0 265 232 246 ^B				
					RDK	0 265 232 249 ^B				
 1.2	11.01-04.05	47					0 265 005 252			
	11.04-06.06	47					0 265 005 692			
	05.06-11.09	51					0 265 005 692			
1.4	09.01-05.02	74					0 265 005 252			
	01.02-04.04	55					0 265 005 252			
	04.02-04.04	74	Fg.-Nr. →6L..4..232 600				0 265 005 252			
	05.04-12.07	55					0 265 005 692			
	05.04-11.09	74	Fg.-Nr. 6L..4..232 601→				0 265 005 692			
1.4, TDI	05.05-11.09	59/63					0 265 005 692			
1.4 TDI	05.02-04.04	55	Fg.-Nr. →6L..4..232 600				0 265 005 252			
	05.04-12.05	55	Fg.-Nr. 6L..4..232 601→				0 265 005 692			
	05.05-11.09	51					0 265 005 692			
1.6	04.03-04.04	74	Fg.-Nr. →6L..4..232 600				0 265 005 252			
	05.04-11.09	74	Fg.-Nr. 6L..4..232 601→				0 265 005 692			
	11.06-11.09	77					0 265 005 692			
1.8 T	12.03-04.04	110	Fg.-Nr. →6L..4..232 600				0 265 005 252			
	05.04-11.09	110	Fg.-Nr. 6L..4..232 601→				0 265 005 692			
1.8 T Cupra R	05.04-02.08	132					0 265 005 692			
1.9 SDI	01.02-04.04	47	Fg.-Nr. →6L..4..232 600				0 265 005 252			
	05.04-12.05	47	Fg.-Nr. 6L..4..232 601→				0 265 005 692			
1.9 TDI	09.01-04.04	74/96/118	Fg.-Nr. →6L..4..232 600				0 265 005 252			
1.9 TDI Cupra R	05.04-11.05	74/96/118	Fg.-Nr. 6L..4..232 601→				0 265 005 692			
	05.05-11.09	74/96/118					0 265 005 692			
2.0	07.02-04.04	85					0 265 005 252			
	05.04-11.09	85	Fg.-Nr. 6L..4..232 601→				0 265 005 692			



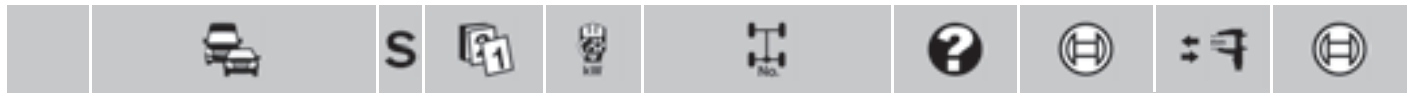

SEAT Ibiza [6L1]

	1.2		11.01-11.09	44/47/51		0 265 005 303	
	1.4, TDI		09.01-11.09	51/55/59/63/74		0 265 005 303	
	1.6		04.03-11.09	74/77		0 265 005 303	
	1.8 T, T Cupra R		12.03-11.09	110/132		0 265 005 303	
	1.9 SDI, TDI, TDI Cupra R		09.01-11.09	47/74/96/118		0 265 005 303	
	2.0		07.02-11.09	85		0 265 005 303	

Inca [6K9]



	1.4	ABO	11.95-12.97	44		JBH	F 026 003 563	22
			11.95-06.03	44		JBH,LLE	0 986 480 987	23,81
			09.97-07.98	44	Fg.-Nr. →9K..X..006 000	JBH,RLE	F 026 003 563	22
			09.97-06.03	44		JBH,LLE	F 026 003 563	22
			08.98-06.03	44	Fg.-Nr. 9K..X..006 001→	RLE	0 204 123 521	22,22
			09.00-06.03	44		RLE	0 204 123 521	22,22
			55		JBH,LLE	F 026 003 563	22	
					RLE	0 204 123 521	22,22	
		ABS	09.00-06.03	44		JBH,LLE	0 986 480 987	23,81
				55		JBH,LLE	0 986 480 987	23,81
	1.6	ABO	11.95-05.97	55		JBH	F 026 003 563	22
			11.95-09.00	55		JBH,LLE	0 986 480 987	23,81
06.97-07.98			55	Fg.-Nr. →9K..X..006 000	JBH,RLE	F 026 003 563	22	
06.97-09.00			55		JBH,LLE	F 026 003 563	22	
08.98-09.00			55	Fg.-Nr. 9K..X..006 001→	RLE	0 204 123 521	22,22	
1.7 D	ABO	09.96-07.98	42	Fg.-Nr. →9K..X..006 000	JBH,RLE	F 026 003 563	22	
		09.96-09.00	42		JBH,LLE	F 026 003 563	22	
						0 986 480 987	23,81	
		08.98-09.00	42	Fg.-Nr. 9K..X..006 001→	RLE	0 204 123 521	22,22	
1.9 D	ABO	11.95-06.03	47		JBH,LLE	0 986 480 987	23,81	
		08.98-06.03	47	Fg.-Nr. 9K..X..006 001→	RLE	0 204 123 521	22,22	
1.9 D	ABO	11.95-07.98	47	Fg.-Nr. →9K..X..006 000	JBH,RLE	F 026 003 563	22	
1.9 SDI		11.95-06.03	47		JBH,LLE	F 026 003 563	22	
1.9 SDI	ABO	12.95-09.00	47		JBH,LLE	0 986 480 987	23,81	
		08.98-09.00	47	Fg.-Nr. 9K..X..006 001→	RLE	0 204 123 521	22,22	
		09.00-06.03	47		RLE	0 204 123 521	22,22	
		ABS	09.00-06.03	47		JBH,LLE	0 986 480 987	23,81

	1.4	ABO	11.95-06.03	44/55		RLE	0 204 125 263	
	1.6	ABO	11.95-09.00	55		RLE	0 204 125 263	
	1.7 D	ABO	09.96-09.00	42		RLE	0 204 125 263	
	1.9 D, SDI	ABO	11.95-06.03	47		RLE	0 204 125 263	

	1.9 SDI		09.00-06.03	47		LLE	0 986 486 109	15,8
--	----------------	--	-------------	----	--	-----	----------------------	------

























	1.9 SDI		09.00-06.03	47			0 986 486 542	23,81
--	----------------	--	-------------	----	--	--	----------------------	-------

	1.4		11.95-06.03	44/55			0 204 031 290^A	
	1.6		11.95-09.00	55			0 204 031 290^A	
	1.7 D		09.96-09.00	42			0 204 031 290^A	
	1.9 D, SDI		11.95-06.03	47			0 204 031 290^A	

Leon Cupra R [1M1]



	1.8 T		05.02-06.06	154/165		LLE	0 986 486 031	15,87
						RLE	0 986 486 060	15,87

		S											
	1.8 T	05.02-06.06	154/165										
										FSG	0 986 486 595	29	
										FSZ	0 986 486 542	23,81	
Leon Cupra SC [5F5]													
													
	2.0 TSI	10.13→	195/206	PR-Code OEM, PR-Code OEC					0 986 486 554	19,05			
Leon Cupra [1M1]													
													
	2.8 Syncro	MFD 10.00-04.04	150			JBH,LLE,M20			0 986 481 022	23,81			
									OFD 10.00-04.04	150	LLE	F 026 003 339	23,81
											RLE	0 204 123 406	23,81
	2.8 Syncro	OFD 10.00-04.04	150	PR-Code 1AC, PR-Code 1AJ, PR-Code 1AH PR-Code 1AM		RLE			0 204 125 505				
											LLE	0 204 125 717	
											RLE	0 204 125 719	
	2.8 Syncro	10.00-04.04	150						LLE	0 986 486 031	15,87		
									RLE	0 986 486 060	15,87		
	2.8 Syncro	10.00-04.04	150						0 986 486 595	29			
									FSG	0 986 486 542	23,81		
									FSZ	0 986 486 538	19		
Leon Cupra [1P1]													
													
	2.0 TFSI	09.09-12.12	195						0 986 486 595	29			
Leon Cupra [5F1]													
													
	2.0 TSI	10.13→	195/ 206-210	PR-Code OEM, PR-Code OEC					0 986 486 554	19,05			
Leon SC [5F5]													
													
	1.2 TSI	01.13→	63/77						0 986 486 554	19,05			
		05.14→	81	PR-Code OEM, PR-Code OEC					0 986 486 554	19,05			
	1.4 TSI	02.13-04.13	103						0 986 486 576	19			
		02.13→	90						0 986 486 554	19,05			
		05.14→	92	PR-Code OEM, PR-Code OEC					0 986 486 554	19,05			
	1.4 TSI ACT	05.14→	110	PR-Code OEM, PR-Code OEC					0 986 486 554	19,05			
	1.6 TDI	02.13-04.13	66/77						0 986 486 576	19			
		11.14→	81		TW				0 986 486 554	19,05			
	1.8 TSI	02.13-04.13	132						0 986 486 576	19			
	Leon ST Cupra [5F8]												
													
	2.0 TSI	07.14→	195/206	PR-Code OEM, PR-Code OEC					0 986 486 554	19,05			



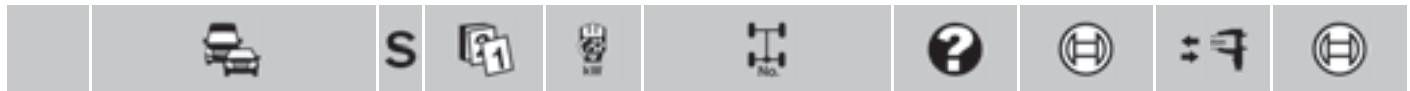

SEAT

Leon ST [5F8]













	1.2 TSI	05.14→	81	PR-Code OEM, PR-Code OEC	0 986 486 554	19,05
	1.4 TGI, TSI, TSI ACT	05.14→	81/92/110	PR-Code OEM, PR-Code OEC	0 986 486 554	19,05
	1.6 TDI	11.14→	81	TW	0 986 486 554	19,05
	1.6 TDI 4x4	02.14→	77	PR-Code OEM, PR-Code OEC	0 986 486 554	19,05
	1.8 TSI 4Drive	11.14→	132	PR-Code OEM, PR-Code OEC	0 986 486 554	19,05
	2.0 TDI, TDI 4Drive, TDI 4WD	05.14→	110	PR-Code OEM, PR-Code OEC	0 986 486 554	19,05

Leon [1M1]



	1.4	MFD 12.99-04.04	55		JBH,LLE,M20	0 986 481 022	23,81	
		OFD 12.99-04.04	55		LLE	F 026 003 339	23,81	
					RLE	0 204 123 406	23,81	
	1.6	MFD 10.98-06.06	74/77		JBH,LLE,M20	0 986 481 022	23,81	
		OFD 10.98-07.04	74		LLE	F 026 003 339	23,81	
						RLE	0 204 123 406	23,81
			06.00-06.06	77		LLE	F 026 003 339	23,81
						RLE	0 204 123 406	23,81
				10.05-06.06	75		RLE	0 204 123 406
				Fg.-Nr. →1M..5..064 060	LLE	F 026 003 339	23,81	
	1.8, T, T Syncro	MFD 10.98-07.04	92/132		JBH,LLE,M20	0 986 481 022	23,81	
		OFD 10.98-07.04	92/132		LLE	F 026 003 339	23,81	
					RLE	0 204 123 406	23,81	
	1.9 SDI	OFD 03.99-07.04	50/66		LLE	F 026 003 339	23,81	
	1.9 TDI				RLE	0 204 123 406	23,81	
	1.9 SDI, TDI, TDI Syncro	MFD 10.98-06.06	50/66/81/ 96/110		JBH,LLE, M20	0 986 481 022	23,81	
		OFD 10.98-06.06	81/96		LLE	F 026 003 339	23,81	
					RLE	0 204 123 406	23,81	
			09.00-02.05	110	Fg.-Nr. →1M..5..064 060	LLE	F 026 003 339	23,81
			10.05-06.06	74		RLE	0 204 123 406	23,81
					Fg.-Nr. →1M..5..064 060	LLE	F 026 003 339	23,81
	1.9 TDI Syncro	OFD 09.00-07.04	110		LLE	F 026 003 339	23,81	
	1.9 TDI, TDI Syncro	OFD 09.00-12.05	110		RLE	0 204 123 406	23,81	
	2.8	MFD 10.00-07.01	150		JBH,LLE,M20	0 986 481 022	23,81	
			05.02-04.04	150		JBH,LLE,M20	0 986 481 022	23,81
		OFD 10.00-07.01	150		LLE	F 026 003 339	23,81	
					RLE	0 204 123 406	23,81	
			05.02-04.04	150		LLE	F 026 003 339	23,81
						RLE	0 204 123 406	23,81

	1.4	OFD 12.99-04.04	55	PR-Code 1AC, PR-Code 1AJ, PR-Code 1AH	RLE	0 204 125 505		
				PR-Code 1AM	LLE	0 204 125 717		
					RLE	0 204 125 719		
	1.6	OFD 10.98-07.04	74	PR-Code 1AC, PR-Code 1AJ, PR-Code 1AH	RLE	0 204 125 505		
				PR-Code 1AM	LLE	0 204 125 717		
					RLE	0 204 125 719		
			06.00-06.06	77	PR-Code 1AC, PR-Code 1AJ, PR-Code 1AH	RLE	0 204 125 505	
					PR-Code 1AM	LLE	0 204 125 717	
						RLE	0 204 125 719	
		10.05-06.06	75		RLE	0 204 125 505		
				PR-Code 1AM	LLE	0 204 125 717		
	1.8	OFD 10.98-07.04	92/132	PR-Code 1AC, PR-Code 1AJ, PR-Code 1AH	RLE	0 204 125 505		
	1.8 T							
	1.8 T Syncro			PR-Code 1AM	LLE	0 204 125 717		
					RLE	0 204 125 719		

		S							
1.9 SDI		OFD	03.99-07.04	50/66	PR-Code 1AC, PR-Code 1AJ, PR-Code 1AH	RLE	0 204 125 505		
1.9 TDI					PR-Code 1AM	LLE	0 204 125 717		
						RLE	0 204 125 719		
1.9 TDI		OFD	10.98-06.06	81/96	PR-Code 1AC, PR-Code 1AJ, PR-Code 1AH	RLE	0 204 125 505		
					PR-Code 1AM	LLE	0 204 125 717		
						RLE	0 204 125 719		
			09.00-12.05	110		RLE	0 204 125 505		
					PR-Code 1AM	LLE	0 204 125 717		
			10.05-06.06	74		RLE	0 204 125 505		
					PR-Code 1AM	LLE	0 204 125 717		
1.9 TDI Syncro		OFD	09.00-07.04	110	PR-Code 1AC, PR-Code 1AJ, PR-Code 1AH	RLE	0 204 125 505		
					PR-Code 1AM	LLE	0 204 125 717		
						RLE	0 204 125 719		
2.8		OFD	10.00-07.01	150	PR-Code 1AC, PR-Code 1AJ, PR-Code 1AH	RLE	0 204 125 505		
					PR-Code 1AM	LLE	0 204 125 717		
						RLE	0 204 125 719		
			05.02-04.04	150	PR-Code 1AC, PR-Code 1AJ, PR-Code 1AH	RLE	0 204 125 505		
					PR-Code 1AM	LLE	0 204 125 717		
						RLE	0 204 125 719		
	1.4		12.99-04.04	55		LLE	0 986 486 031	15,87	
						RLE	0 986 486 060	15,87	
	1.6		10.98-06.06	74/75/77		LLE	0 986 486 031	15,87	
						RLE	0 986 486 060	15,87	
	1.8, T, T Syncro		10.98-07.04	92/132		LLE	0 986 486 031	15,87	
						RLE	0 986 486 060	15,87	
	1.9 SDI, TDI, TDI Syncro		10.98-06.06	50/66/74/ 81/96/110		LLE	0 986 486 031	15,87	
						RLE	0 986 486 060	15,87	
	2.8		10.00-07.01	150		LLE	0 986 486 031	15,87	
						RLE	0 986 486 060	15,87	
			05.02-04.04	150		LLE	0 986 486 031	15,87	
						RLE	0 986 486 060	15,87	
	1.4		12.99-04.04	55		FSG	0 986 486 542	23,81	
						FSZ	0 986 486 538	19	
	1.6		10.98-06.06	74/75/77		FSG	0 986 486 542	23,81	
						FSZ	0 986 486 538	19	
	1.8		10.98-07.04	92		FSG	0 986 486 542	23,81	
						FSZ	0 986 486 538	19	
	1.8 T		12.99-04.04	132		FSG	0 986 486 542	23,81	
	1.8 T Syncro					FSZ	0 986 486 538	19	
			09.00-04.04	132			0 986 486 595	29	
	1.9 SDI		10.98-06.06	50/66/74/		FSG	0 986 486 542	23,81	
	1.9 TDI			81		FSZ	0 986 486 538	19	
	1.9 TDI		09.00-06.06	96/110			0 986 486 595	29	
	1.9 TDI Syncro					FSG	0 986 486 542	23,81	
						FSZ	0 986 486 538	19	
	2.8		10.00-07.01	150			0 986 486 595	29	
						FSG	0 986 486 542	23,81	
						FSZ	0 986 486 538	19	
			05.02-04.04	150			0 986 486 595	29	
						FSG	0 986 486 542	23,81	
						FSZ	0 986 486 538	19	



SEAT

Leon [1P1]



	1.2 TSI	02.10-12.12	77		JBH,LLE	0986 480 870	22
	1.4	06.06-05.10	63		LLE BO	F 026 003 715	22,2
		05.10-12.12	63		JBH,LLE	0986 480 870	22
	1.4 TSI	11.07-12.12	92		JBH,LLE	0986 480 870	22
	1.6, MultiFuel, TDI	07.05-12.12	66/75		JBH,LLE	0986 480 870	22
	1.6 TDI	02.10-12.12	77		LLE BO	F 026 003 715	22,2
					JBH,LLE	ATE 0986 480 870	22
	1.8 TSI	06.07-03.09	118		LLE BO	F 026 003 715	22,2
					JBH,LLE,	0986 480 870	22
					TW	ATE 0986 480 870	22
		03.09-12.12	118		JBH,LLE	0986 480 870	22
	1.9 TDI	07.05-02.06	77		LLE BO	F 026 003 715	22,2
					JBH,LLE,	0986 480 870	22
					TW	ATE 0986 480 870	22
		11.05-12.10	77		JBH,LLE	0986 480 870	22
		06.07-12.10	66		JBH,LLE	0986 480 870	22
	2.0 FSI	05.05-05.09	110/125/		LLE BO	F 026 003 715	22,2
	2.0 TDI		136-147/		JBH,LLE,	0986 480 870	22
	2.0 TFSI		177		TW	ATE 0986 480 870	22
	2.0 TDI	07.05-03.09	100		LLE BO	F 026 003 715	22,2
					JBH,LLE,	0986 480 870	22
					TW	ATE 0986 480 870	22
		07.05-12.12	103		JBH,LLE	0986 480 870	22



















	1.4	06.06-05.10	63		LLE BO	0 204 055 051	
	1.8 TSI	06.07-03.09	118		LLE,TW	0 204 055 051	
	1.9 TDI	07.05-02.06	77		LLE,TW	0 204 055 051	
	2.0 FSI, TDI, TFSI	05.05-05.09	100/110/125/136-147/177		LLE,TW	0 204 055 051	

	1.2 TSI	02.10-12.12	77			0986 486 576	19
	1.4	06.06-05.10	63			0986 486 576	19
		05.10-12.12	63		TW	0986 486 554	19,05
						0986 486 576	19
	1.4 TSI	11.07-12.12	92			0986 486 576	19
	1.6	07.05-12.12	75		TW	0986 486 554	19,05
	1.6 MultiFuel					0986 486 576	19
	1.6 TDI	02.10-12.12	66/77			0986 486 576	19
	1.8 TSI	06.07-12.12	118			0986 486 576	19
	1.9 TDI	07.05-12.10	66/77			0986 486 576	19
	2.0 FSI	07.05-03.09	110			0986 486 576	19
	2.0 FSI, TFSI	05.05-12.12	136-147/155/177			0986 486 595	29
	2.0 TDI	07.05-03.09	100			0986 486 595	29
		07.05-05.11	103/125			0986 486 595	29
		03.09-12.12	103/125			0986 486 576	19

Leon [5F1]

















	1.2 TSI	12.12→	63/77			0986 486 554	19,05
		04.14→	81	PR-Code OEM, PR-Code OEC		0986 486 554	19,05
	1.4 TGI	10.13→	81	PR-Code OEM, PR-Code OEC		0986 486 554	19,05
	1.4 TSI	09.12→	90			0986 486 554	19,05
			103			0986 486 576	19
		05.14→	92	PR-Code OEM, PR-Code OEC		0986 486 554	19,05
	1.4 TSI ACT	05.14→	110	PR-Code OEM, PR-Code OEC		0986 486 554	19,05
	1.6 TDI	09.12→	66/77			0986 486 576	19
		11.14→	81		TW	0986 486 554	19,05
	1.8 TSI	02.13-04.13	132			0986 486 576	19

									
Marbella									
									
	0.9	01.87-05.98	29-30			BKV,JBH	F 026 003 180		20,6
	0.9i					BKV	0 204 122 112		19
	0.9	01.87-05.98	29-30				0 204 131 716		
	0.9i						0 204 131 717^A		
Terra									
									
	0.9	01.87-12.94	29			BKV,JBH	F 026 003 180		20,6
						BKV	0 204 122 112		19
	1.3D	03.90-12.94	33			BKV,JBH	F 026 003 180		20,6
						BKV	0 204 122 112		19
	1.4D	10.90-12.94	35			BKV,JBH	F 026 003 180		20,6
						BKV	0 204 122 112		19
Toledo [KG3]									
									
	1.2, TSI	07.12→	55/63/77				0 986 486 554		19,05
	1.6	07.12→	77				0 986 486 554		19,05
	1.6 TDI	07.12→	77				0 986 486 553		19,05
		10.13→	66				0 986 486 553		19,05
Toledo [1L2]									
									
	1.6	02.92-01.94	55	Fg.-Nr. 1L..ZD101 451→		JBH	F 026 003 562		20,6
				1L..ZD 315 000					
		02.94-03.99	55	Fg.-Nr. 1L..ZD315 001→		JBH	F 026 003 563		22
	ABO	02.92-01.94	55	Fg.-Nr. 1L..ZD101 451→		JBH	F 026 003 562		20,6
				1L..ZD 315 000					
		11.96-03.99	74			JBH	F 026 003 563		22
	ABS	09.95-03.99	55	Fg.-Nr. 1L..TR000 001→		JBH,LLE	0 986 480 987		23,81
							0 986 481 016		22,2
						JBH,RLE	0 986 480 869		22
		11.96-03.99	74			JBH,LLE	0 986 480 987		23,81
							0 986 481 016		22,2
						JBH,RLE	0 986 480 869		22
	1.8	02.94-07.94	66	Fg.-Nr. 1L..ZD315 001→		JBH	F 026 003 563		22
	ABO	11.93-01.94	66	Fg.-Nr. →1L..ZD 315 000		JBH	F 026 003 562		20,6
		07.94-03.99	66			JBH	F 026 003 563		22
	ABS	05.91-03.94	95			JBH,LLE	0 986 480 878		23,8
		09.95-09.96	66			JBH,LLE	0 986 480 987		23,81
							0 986 481 016		22,2
						JBH,RLE	0 986 480 869		22
		09.95-03.99	66	Fg.-Nr. 1L..TR000 001→		JBH,LLE	0 986 480 987		23,81
							0 986 481 016		22,2
						JBH,RLE	0 986 480 869		22
	1.9 D	02.94-03.99	47/55	Fg.-Nr. 1L..ZD315 001→		JBH	F 026 003 563		22
	1.9 TD	ABO	05.91-01.94	47/55	Fg.-Nr. →1L..ZD 315 000	JBH	F 026 003 562		20,6
		ABS	09.95-03.99	47/55	Fg.-Nr. 1L..TR000 001→	JBH,LLE	0 986 480 987		23,81
							0 986 481 016		22,2
						JBH,RLE	0 986 480 869		22
	1.9 TDI	ABO	04.95-03.99	66/81		JBH	F 026 003 563		22
		ABS	04.95-08.95	66	Fg.-Nr. →1L..TR000 000	JBH,LLE	0 986 480 878		23,8
			09.95-12.96	66	Fg.-Nr. 1L..TR000 001→	JBH,LLE	0 986 480 987		23,81
							0 986 481 016		22,2
						JBH,RLE	0 986 480 869		22



		S														
SEAT Toledo [1L2]																
	1.9 TDI	ABS	06.96-03.99	66		JBH,LLE	0986 480 987	23,81								
							0986 481 016	22,2								
							0986 480 869	22								
			11.96-03.99		81		JBH,LLE	0986 480 987	23,81							
								0986 481 016	22,2							
								0986 480 869	22							
	2.0	03.94-08.95	110		Fg.-Nr. →1L..TR000 000	JBH,LLE	0986 480 878	23,8								
							09.95-03.99	110	Fg.-Nr. 1L..TR000 001→	JBH,LLE	0986 480 987	23,81				
											0986 481 016	22,2				
		0986 480 869	22													
			03.96-03.99	85			JBH,LLE	0986 480 987	23,81							
								0986 481 016	22,2							
0986 480 869	22															
ABS	05.91-08.95	85		Fg.-Nr. →1L..TR000 000	JBH,LLE	0986 480 878	23,8									
						09.95-06.96	85	Fg.-Nr. 1L..TR000 001→	JBH,LLE	0986 480 987	23,81					
										0986 481 016	22,2					
0986 480 869	22															
	1.6	05.91-03.99	55			0986 486 041	19									
	1.9 TDI	04.95-03.99	66/81			0986 486 041	19									
	2.0	03.94-03.99	110			0986 486 041	19									
	1.6	05.91-03.99	55			0986 486 537	23,8									
	1.9 TDI	04.95-03.99	66/81			0986 486 537	23,8									
	2.0	03.94-03.99	110			0986 486 537	23,8									
	1.6	05.91-03.99	55/74			0986 482 006 ^A										
	1.8	05.91-03.99	66/95			0986 482 006 ^A										
	1.9 D, TD, TDI	05.91-03.99	47/55/66/81			0986 482 006 ^A										
	2.0	05.91-03.99	85			0986 482 006 ^A										
		03.94-03.99	110			0 204 131 697 ^A										
Toledo [1M2]																
	1.4	MFD	01.00-05.02	55		JBH,LLE,M20	0986 481 022	23,81								
							OFD	01.00-05.02	55		LLE	F 026 003 339	23,81			
												RLE	0 204 123 406	23,81		
	1.6	MFD	10.98-07.04	74/77		JBH,LLE,M20	0986 481 022	23,81								
							OFD	10.98-07.04	74/77		LLE	F 026 003 339	23,81			
												RLE	0 204 123 406	23,81		
	1.8	MFD	10.98-07.04	92/132		JBH,LLE,M20	0986 481 022	23,81								
							1.8 T	OFD	10.98-07.04	92/132		LLE	F 026 003 339	23,81		
													RLE	0 204 123 406	23,81	
	1.9 TDI	MFD	10.98-07.04	66/81/96/110		JBH,LLE,M20	0986 481 022	23,81								
							OFD	10.98-07.04	66/81/96/110		LLE	F 026 003 339	23,81			
												RLE	0 204 123 406	23,81		
	2.3	MFD	10.98-11.03	110/125		JBH,LLE,M20	0986 481 022	23,81								
							OFD	10.98-11.03	110/125		LLE	F 026 003 339	23,81			
												RLE	0 204 123 406	23,81		
	1.4	OFD	01.00-05.02	55	PR-Code 1AC, PR-Code 1AJ, PR-Code 1AH		LLE	0 204 125 717								
								1.6	OFD	10.98-07.04	74/77	PR-Code 1AC, PR-Code 1AJ, PR-Code 1AH		RLE	0 204 125 719	
															1.8	OFD
	1.8 T	OFD	10.98-07.04	92/132	PR-Code 1AC, PR-Code 1AJ, PR-Code 1AH		RLE	0 204 125 719								
								PR-Code 1AQ		RLE	0 204 125 505					
											PR-Code 1AQ		RLE	0 204 125 505		

		S							
1.9 TDI	OFD	10.98-07.04	66/81/96/110	PR-Code 1AC, PR-Code 1AJ, PR-Code 1AH, PR-Code 1AQ	LLE, RLE		0 204 125 717, 0 204 125 719, 0 204 125 505		
2.3	OFD	10.98-11.03	110/125	PR-Code 1AC, PR-Code 1AJ, PR-Code 1AH, PR-Code 1AQ	LLE, RLE		0 204 125 717, 0 204 125 719, 0 204 125 505		
 1.4		01.00-05.02	55		LLE, RLE		0 986 486 031, 0 986 486 060	15,87	
1.6		10.98-07.04	74/77		LLE, RLE		0 986 486 031, 0 986 486 060	15,87	
1.8		10.98-07.04	92/132		LLE, RLE		0 986 486 031, 0 986 486 060	15,87	
1.8 T					RLE		0 986 486 060	15,87	
1.9 TDI		10.98-07.04	66/81/96/110		LLE, RLE		0 986 486 031, 0 986 486 060	15,87	
2.3		10.98-11.03	110/125		LLE, RLE		0 986 486 031, 0 986 486 060	15,87	
 1.4		01.00-05.02	55		FSG, FSZ		0 986 486 542, 0 986 486 538	23,81	
1.6		10.98-07.04	74/77		FSZ		0 986 486 538	19	
		04.99-07.04	74/77		FSG		0 986 486 542	23,81	
1.8		10.98-07.04	92/132		FSZ		0 986 486 538	19	
1.8 T		04.99-07.04	92/132		FSG		0 986 486 542	23,81	
1.9 TDI		10.98-07.04	66/81/96/110		FSZ		0 986 486 538	19	
		04.99-07.04	66/81/96/110		FSG		0 986 486 542	23,81	
2.3		10.98-11.03	110/125		FSZ		0 986 486 538	19	
		04.99-11.03	110/125		FSG		0 986 486 542	23,81	
Toledo [5P2]									
									
 1.4		05.06-05.09	63/92		LLE, BO	F 026	003 715	22,2	
1.4 TSI					JBH, LLE	ATE	0 986 480 870	22	
1.6		09.04-05.09	75		LLE, BO	F 026	003 715	22,2	
					JBH, LLE	ATE	0 986 480 870	22	
1.8 TSI		01.07-05.09	118		LLE, BO	F 026	003 715	22,2	
					JBH, LLE	ATE	0 986 480 870	22	
1.9 TDI		09.04-05.09	77		LLE, BO	F 026	003 715	22,2	
					JBH, LLE	ATE	0 986 480 870	22	
2.0 FSI, TDI, TFSI		09.04-05.09	100/103/110/125/147		LLE, BO	F 026	003 715	22,2	
					JBH, LLE	ATE	0 986 480 870	22	
 1.4, TSI		05.06-05.09	63/92		LLE, TW		0 204 055 051		
1.6		09.04-05.09	75		LLE, TW		0 204 055 051		
1.8 TSI		01.07-05.09	118		LLE, TW		0 204 055 051		
1.9 TDI		09.04-05.09	77		LLE, TW		0 204 055 051		
2.0 FSI, TDI, TFSI		09.04-05.09	100/103/110/125/147		LLE, TW		0 204 055 051		
 1.4		05.06-05.09	63/92		TW		0 986 486 554	19,05	
1.4 TSI							0 986 486 576	19	
1.6		09.04-05.09	75		TW		0 986 486 554	19,05	
							0 986 486 576	19	
1.8 TSI		01.07-05.09	118		TW		0 986 486 554	19,05	
							0 986 486 576	19	
1.9 TDI		09.04-05.09	77		TW		0 986 486 554	19,05	
							0 986 486 576	19	
2.0 FSI		09.04-03.09	110		TW		0 986 486 554	19,05	
							0 986 486 576	19	
2.0 TDI		09.04-05.09	100/103				0 986 486 595	29	
2.0 TDI, TFSI		11.05-05.09	125/147				0 986 486 595	29	



SKODA

Fabia Combi [NJ5]













	1.0 MPI	08.14->	44/55		MQO	0986 486 554	19,05
	1.2 TSI	08.14->	66/81		MQO	0986 486 554	19,05

Fabia Combi [5J5]











	1.2	ABO	12.06-02.10	44/51	PR-Code 1LB, PR-Code 1LM	LLE	0 204 024 227	20,64
					PR-Code 1LQ, PR-Code 1LN, PR-Code 1LR	JBH,LLE	0986 480 850	20,6
		ABS	12.06-02.10	44/51	PR-Code 1LN, PR-Code 1LQ, PR-Code 1LR, PR-Code 1AT	JBH,LLE	0986 480 820	20,6
	1.4	ABS	10.07-03.10	63		JBH	0986 480 820	20,6
					PR-Code 1LN, PR-Code 1LQ, PR-Code 1LR, PR-Code 1AT	JBH,LLE	0986 480 820	20,6
	1.4	ABO	10.07-03.10	51/59/63	PR-Code 1LB, PR-Code 1LM	LLE	0 204 024 227	20,64
	1.4 TDI				PR-Code 1LQ, PR-Code 1LN, PR-Code 1LR	JBH,LLE	0986 480 850	20,6
	1.4 TDI	ABS	10.07-03.10	51/59	PR-Code 1LN, PR-Code 1LQ, PR-Code 1LR, PR-Code 1AT	JBH,LLE	0986 480 820	20,6
	1.6	ABO	10.07-02.10	77	PR-Code 1LB, PR-Code 1LM	LLE	0 204 024 227	20,64
					PR-Code 1LQ, PR-Code 1LN, PR-Code 1LR	JBH,LLE	0986 480 850	20,6
		ABS	10.07-02.10	77	PR-Code 1LN, PR-Code 1LQ, PR-Code 1LR, PR-Code 1AT	JBH,LLE	0986 480 820	20,6
			10.07-07.10	77		JBH	0986 480 820	20,6
	1.9 TDI	ABO	10.07-03.10	77	PR-Code 1LB, PR-Code 1LM	LLE	0 204 024 227	20,64
					PR-Code 1LQ, PR-Code 1LN, PR-Code 1LR	JBH,LLE	0986 480 850	20,6
		ABS	10.07-03.10	77	PR-Code 1LN, PR-Code 1LQ, PR-Code 1LR, PR-Code 1AT	JBH,LLE	0986 480 820	20,6

	1.2		12.06-12.14	44/51			0986 486 060	15,87
	1.4, TDI		10.07-03.10	51/59/63			0986 486 060	15,87
	1.6		10.07-07.10	77			0986 486 060	15,87
	1.9 TDI		10.07-03.10	77			0986 486 060	15,87

	1.2		12.06-11.11	44	PR-Code 0EJ		0986 486 553	19,05
					PR-Code OEM		0986 486 554	19,05
			10.07-12.14	51	PR-Code 0EJ		0986 486 553	19,05
					PR-Code OEM		0986 486 554	19,05
			11.11-12.14	44		MQO	0986 486 554	19,05
						MQ2	0986 486 553	19,05
	1.2		03.10-12.14	55/63/77	PR-Code 0EJ		0986 486 553	19,05
	1.2 TDI				PR-Code OEM		0986 486 554	19,05
	1.4		10.07-03.10	63	PR-Code 0EJ		0986 486 553	19,05
					PR-Code OEM		0986 486 554	19,05
			03.10-12.14	63			0986 486 554	19,05
	1.4 TDI		10.07-03.10	51/59	PR-Code 0EJ		0986 486 553	19,05
					PR-Code OEM		0986 486 554	19,05
	1.4 TSI		05.10-12.14	132	PR-Code 0EJ	MQ2	0986 486 553	19,05
	1.4 TSI RS				PR-Code OEM	MQO	0986 486 554	19,05
	1.6		10.07-07.10	77	PR-Code 0EJ		0986 486 553	19,05
					PR-Code OEM		0986 486 554	19,05
			06.10-12.14	77			0986 486 554	19,05
	1.6 TDI		04.10-12.14	55	PR-Code 0EJ	MQ2	0986 486 553	19,05
					PR-Code OEM	MQO	0986 486 554	19,05









		S							
1.9 TDI		10.07-03.10	77				PR-Code OEJ 0 986 486 553	19,05	
							PR-Code OEM 0 986 486 554	19,05	
 1.2		12.06-05.09	44/51			TW	0 204 031 681 ^A 0 204 031 682 ^A		
1.4		10.07-03.10	51/59/63			TW	0 204 031 681 ^A 0 204 031 682 ^A		
1.4 TDI									
1.6		10.07-07.10	77			TW	0 204 031 681 ^A 0 204 031 682 ^A		
1.9 TDI		10.07-03.10	77			TW	0 204 031 681 ^A 0 204 031 682 ^A		
 1.2		12.06-12.14	44/51			RDK	0 265 232 278 ^B 0 265 232 284 ^F 0 265 234 714 ^T		
						RDK	0 265 232 281 ^B 0 265 232 287 ^F 0 265 234 717 ^T		
1.4		10.07-03.10	63			RDK	0 265 232 278 ^B 0 265 232 284 ^F 0 265 234 714 ^T		
						RDK	0 265 232 281 ^B 0 265 232 287 ^F 0 265 234 717 ^T		
1.4 TDI		10.07-02.10	51/59			RDK	0 265 232 278 ^B 0 265 232 284 ^F 0 265 234 714 ^T		
						RDK	0 265 232 281 ^B 0 265 232 287 ^F 0 265 234 717 ^T		
1.6		10.07-02.10	77			RDK	0 265 232 278 ^B 0 265 232 284 ^F 0 265 234 714 ^T		
						RDK	0 265 232 281 ^B 0 265 232 287 ^F 0 265 234 717 ^T		
1.9 TDI		10.07-02.10	77			RDK	0 265 232 278 ^B 0 265 232 284 ^F 0 265 234 714 ^T		
						RDK	0 265 232 281 ^B 0 265 232 287 ^F 0 265 234 717 ^T		
 1.2		12.06-06.09	44/51				0 265 005 692		
1.4, TDI		10.07-03.10	51/59/63				0 265 005 692		
1.6		10.07-07.10	77				0 265 005 692		
1.9 TDI		10.07-03.10	77				0 265 005 692		
Fabia Combi [6Y5]									
									
 1.2		ABO 08.02-12.07	40/47				0 204 024 227	20,64	
1.4		ABO 09.00-12.07	74			JBH	0 986 480 850	20,6	
		ABS 09.00-12.07	74			JBH	0 986 480 820	20,6	
1.4, TDI		ABO 12.99-12.07	44/50/51/55/59				0 204 024 227	20,64	
1.9 SDI		ABO 08.00-12.07	47				0 204 024 227	20,64	
1.9 TDI		ABO 08.00-12.07	74			JBH	0 986 480 850	20,6	
		ABS 08.00-12.07	74			JBH	0 986 480 820	20,6	
2.0		ABO 09.00-12.07	85			JBH	0 986 480 850	20,6	
		ABS 09.00-12.07	85			JBH	0 986 480 820	20,6	

◀ SKODA Fabia Combi [6Y5]										
	1.2	08.02-12.07	40/47		0 986 486 060	15,87				
	1.4, TDI	12.99-12.07	44/50/51/55/59/74		0 986 486 060	15,87				
	1.9 SDI, TDI	08.00-12.07	47/74		0 986 486 060	15,87				
	2.0	09.00-12.07	85		0 986 486 060	15,87				
	1.2	08.02-12.07	40/47	PR-Code OEJ	0 986 486 553	19,05				
				PR-Code OEK	0 986 486 577	19,05				
				PR-Code OEM	0 986 486 554	19,05				
	1.4	12.99-12.07	44/50/51/55/59/74	PR-Code OEJ	0 986 486 553	19,05				
				PR-Code OEK	0 986 486 577	19,05				
				PR-Code OEM	0 986 486 554	19,05				
	1.9 SDI	08.00-12.07	47/74	PR-Code OEJ	0 986 486 553	19,05				
				PR-Code OEK	0 986 486 577	19,05				
				PR-Code OEM	0 986 486 554	19,05				
	2.0	09.00-12.07	85	PR-Code OEJ	0 986 486 553	19,05				
				PR-Code OEK	0 986 486 577	19,05				
				PR-Code OEM	0 986 486 554	19,05				
	1.2	08.02-12.07	40/47		0 204 031 682 ^A					
	1.4, TDI	12.99-12.07	44/50/51/55/59/74		0 204 031 682 ^A					
	1.9 SDI, TDI	08.00-12.07	47/74		0 204 031 682 ^A					
	2.0	09.00-12.07	85		0 204 031 682 ^A					
	1.2	08.02-05.04	40		0 265 224 013 ^F					
					0 265 234 717 ^T					
				02.03-04.04	47	Fg.-Nr. →6Y..4..109 999	0 265 224 013 ^F			
							0 265 234 717 ^T			
				05.04-11.04	47	Fg.-Nr. 6Y..4..110 000→	0 265 231 436 ^B			
							0 265 231 717 ^F			
							0 265 234 363 ^T			
				05.04-04.05	40	Fg.-Nr. →6Y..5..391 600	0 265 231 436 ^B			
							0 265 231 717 ^F			
				05.04-12.07	40		0 265 234 363 ^T			
				11.04-04.05	47	Fg.-Nr. →6Y..5..391 600	0 265 231 436 ^B			
							0 265 231 717 ^F			
	11.04-12.07	47		0 265 234 363 ^T						
	05.05-12.07	40	Fg.-Nr. 6Y..5..391 601→	0 265 231 436 ^B						
				0 265 231 717 ^F						
		47	Fg.-Nr. 6Y..5..391 601→	0 265 231 436 ^B						
				0 265 231 717 ^F						
	1.4	12.99-05.03	44/50		0 265 224 013 ^F					
					0 265 234 717 ^T					
				09.00-08.03	74		0 265 224 013 ^F			
							0 265 234 717 ^T			
				09.00-04.04	74	Fg.-Nr. →6Y..4..109 999	0 265 224 013 ^F			
							0 265 234 717 ^T			
				09.00-05.04	55		0 265 224 013 ^F			
						0 265 234 717 ^T				
05.04-04.05				55	Fg.-Nr. →6Y..5..391 600	0 265 231 436 ^B				
						0 265 231 717 ^F				
				74	Fg.-Nr. 6Y..4..110 000→6Y..5..391 600	0 265 231 436 ^B				
						0 265 231 717 ^F				
05.04-12.07	55		0 265 234 363 ^T							
	74	Fg.-Nr. 6Y..4..110 000→	0 265 234 363 ^T							
05.05-12.07	55	Fg.-Nr. 6Y..5..391 601→	0 265 231 436 ^B							
			0 265 231 717 ^F							
	74	Fg.-Nr. 6Y..5..391 601→	0 265 231 436 ^B							
			0 265 231 717 ^F							
1.4	10.05-12.07	59		0 265 231 436 ^B						
1.4 TDI				0 265 231 717 ^F						
				0 265 234 363 ^T						

		S							
1.4 TDI	05.03-04.04	55	Fg.-Nr. →6Y..4..109 999				0 265 224 013 ^F		
							0 265 234 717 ^T		
	05.04-04.05	55	Fg.-Nr. 6Y..4..110 000→6Y..5..391 600				0 265 231 436 ^B		
							0 265 231 717 ^F		
	05.04-10.05	55	Fg.-Nr. 6Y..4..110 000→				0 265 234 363 ^T		
1.9 SDI	05.05-10.05	55	Fg.-Nr. 6Y..5..391 601→				0 265 231 436 ^B		
							0 265 231 717 ^F		
	10.05-12.07	51					0 265 231 436 ^B		
							0 265 231 717 ^F		
							0 265 234 363 ^T		
1.9 TDI	08.00-04.04	47	Fg.-Nr. →6Y..4..109 999				0 265 224 013 ^F		
							0 265 234 717 ^T		
	05.04-04.05	47	Fg.-Nr. 6Y..4..110 000→6Y..5..391 600				0 265 231 436 ^B		
							0 265 231 717 ^F		
	05.04-12.07	47	Fg.-Nr. 6Y..4..110 000→				0 265 234 363 ^T		
1.9 TDI	05.05-12.07	47	Fg.-Nr. 6Y..5..391 601→				0 265 231 436 ^B		
							0 265 231 717 ^F		
	08.00-04.04	74	Fg.-Nr. →6Y..4..109 999				0 265 224 013 ^F		
							0 265 234 717 ^T		
	05.04-04.05	74	Fg.-Nr. 6Y..4..110 000→6Y..5..391 600				0 265 231 436 ^B		
2.0							0 265 231 717 ^F		
	05.04-10.05	74	Fg.-Nr. 6Y..4..110 000→				0 265 234 363 ^T		
	05.05-10.05	74	Fg.-Nr. 6Y..5..391 601→				0 265 231 436 ^B		
							0 265 231 717 ^F		
	10.05-12.07	74					0 265 231 717 ^F		
2.0							0 265 234 119 ^T		
							0 265 234 700 ^T		
	09.00-04.04	85	Fg.-Nr. →6Y..4..109 999				0 265 224 013 ^F		
							0 265 234 717 ^T		
	05.04-04.05	85	Fg.-Nr. 6Y..4..110 000→6Y..5..391 600				0 265 231 436 ^B		
1.2							0 265 231 717 ^F		
							0 265 234 363 ^T		
	05.04-12.07	85	Fg.-Nr. 6Y..5..391 601→				0 265 231 436 ^B		
							0 265 231 717 ^F		
	08.02-04.04	40/47	Fg.-Nr. →6Y..4..115 000				0 265 005 252		
1.4	05.04-12.07	40/47					0 265 005 692		
	12.99-05.03	44/50					0 265 005 252		
1.4 TDI	09.00-08.03	55					0 265 005 252		
		74					0 265 005 252		
	09.00-04.04	55	Fg.-Nr. →6Y..4..115 000				0 265 005 252		
		74	Fg.-Nr. →6Y..4..115 000				0 265 005 252		
	05.04-12.07	55					0 265 005 692		
1.9 SDI							0 265 005 692		
							0 265 005 692		
	05.04-12.07	51	Fg.-Nr. 6Y..4..115 001→				0 265 005 692		
		59					0 265 005 692		
	08.00-04.04	47/74	Fg.-Nr. →6Y..4..115 000				0 265 005 252		
1.9 TDI	05.04-12.07	47/74	Fg.-Nr. 6Y..4..115 001→				0 265 005 692		
	09.00-04.04	85	Fg.-Nr. →6Y..4..115 000				0 265 005 252		
2.0	05.04-12.07	85	Fg.-Nr. 6Y..4..115 001→				0 265 005 692		
							0 265 005 692		
Fabia [NJ3]									
									
	1.0 MPI	08.14→	44/55		MQO		0 986 486 554	19,05	
	1.2 TSI	08.14→	66/81		MQO		0 986 486 554	19,05	



		S							
◀ SKODA									
Fabia RS [5J2]									
	1.4 TSI	05.10-05.12	132	PR-Code OEJ	MQ2	0986	486 553	19,05	
				PR-Code OEM	MQO	0986	486 554	19,05	
Fabia Schrägheck [6Y2]									
	1.0	ABO 09.99-08.02	37			0 204	024 227	20,64	
	1.2	ABO 07.01-04.07	40/47			0 204	024 227	20,64	
	1.4	ABO 09.99-04.07	74		JBH	0986	480 850	20,6	
		ABS 09.99-04.07	74		JBH	0986	480 820	20,6	
	1.4, TDI	ABO 09.99-04.07	44/50/51/55/59			0 204	024 227	20,64	
	1.9 SDI	ABO 09.99-03.08	47			0 204	024 227	20,64	
	1.9 TDI	ABO 09.99-04.07	74/96		JBH	0986	480 850	20,6	
	1.9 TDI RS	ABS 09.99-04.07	74/96		JBH	0986	480 820	20,6	
	2.0	ABO 07.00-04.07	85		JBH	0986	480 850	20,6	
		ABS 07.00-04.07	85		JBH	0986	480 820	20,6	
	1.0	09.99-08.02	37			0986	486 060	15,87	
	1.2	07.01-04.07	40/47			0986	486 060	15,87	
	1.4, TDI	09.99-04.07	44/50/51/55/59/74			0986	486 060	15,87	
	1.9 SDI, TDI, TDI RS	09.99-03.08	47/74/96			0986	486 060	15,87	
	2.0	07.00-04.07	85			0986	486 060	15,87	
	1.0	09.99-08.02	37	PR-Code OEJ		0986	486 553	19,05	
				PR-Code OEK		0986	486 577	19,05	
				PR-Code OEM		0986	486 554	19,05	
	1.2	07.01-04.07	40/47	PR-Code OEJ		0986	486 553	19,05	
				PR-Code OEK		0986	486 577	19,05	
				PR-Code OEM		0986	486 554	19,05	
	1.4	09.99-04.07	44/50/51/	PR-Code OEJ		0986	486 553	19,05	
	1.4 TDI		55/59/74	PR-Code OEK		0986	486 577	19,05	
				PR-Code OEM		0986	486 554	19,05	
	1.9 SDI	09.99-03.08	47/74	PR-Code OEJ		0986	486 553	19,05	
	1.9 TDI			PR-Code OEK		0986	486 577	19,05	
				PR-Code OEM		0986	486 554	19,05	
	1.9 TDI RS	06.03-10.05	96			0986	486 595	29	
	2.0	07.00-04.07	85	PR-Code OEJ		0986	486 553	19,05	
				PR-Code OEK		0986	486 577	19,05	
				PR-Code OEM		0986	486 554	19,05	
	1.0	09.99-08.02	37			0 204	031 681^A		
	1.2	07.01-04.07	40/47			0 204	031 681^A		
	1.4, TDI	09.99-04.07	44/50/51/55/59/74			0 204	031 681^A		
	1.9 SDI, TDI, TDI RS	09.99-03.08	47/74/96			0 204	031 681^A		
	2.0	07.00-04.07	85			0 204	031 681^A		
	1.0	09.99-08.02	37			0 265	224 013^F		
						0 265	234 717^T		
	1.2	07.01-05.04	40			0 265	224 013^F		
						0 265	234 717^T		
		02.03-04.04	47	Fg.-Nr. →6Y..4..109 999		0 265	224 013^F		
						0 265	234 717^T		
		05.04-11.04	47	Fg.-Nr. 6Y..4..110 000→		0 265	231 436^B		
						0 265	231 717^F		
						0 265	234 363^T		
		05.04-04.05	40	Fg.-Nr. →6Y..5..391 600		0 265	231 436^B		
						0 265	231 717^F		
		05.04-04.07	40			0 265	234 363^T		

		S							
1.2	11.04-04.05	47		Fg.-Nr. →6Y..5..391 600			0 265 231 436 ^B		
							0 265 231 717 ^F		
	11.04-04.07	47					0 265 234 363 ^T		
	05.05-04.07	40		Fg.-Nr. 6Y..5..391 601→			0 265 231 436 ^B		
		47		Fg.-Nr. 6Y..5..391 601→			0 265 231 717 ^F		
1.4	09.99-05.03	44/50					0 265 224 013 ^F		
							0 265 234 717 ^T		
	09.99-08.03	74					0 265 224 013 ^F		
							0 265 234 717 ^T		
	09.99-05.04	55					0 265 224 013 ^F		
							0 265 234 717 ^T		
	09.00-04.04	74		Fg.-Nr. →6Y..4..109 999			0 265 224 013 ^F		
							0 265 234 717 ^T		
	05.04-04.05	55		Fg.-Nr. →6Y..5..391 600			0 265 231 436 ^B		
		74		Fg.-Nr. 6Y..4..110 000→6Y..5..391 600			0 265 231 436 ^B		
							0 265 231 717 ^F		
	05.04-04.07	55					0 265 234 363 ^T		
		74		Fg.-Nr. 6Y..4..110 000→			0 265 234 363 ^T		
	05.05-04.07	55		Fg.-Nr. 6Y..5..391 601→			0 265 231 436 ^B		
		74		Fg.-Nr. 6Y..5..391 601→			0 265 231 717 ^F		
1.4 TDI	05.03-04.04	55		Fg.-Nr. →6Y..4..109 999			0 265 224 013 ^F		
							0 265 234 717 ^T		
	05.04-04.05	55		Fg.-Nr. 6Y..4..110 000→6Y..5..391 600			0 265 231 436 ^B		
							0 265 231 717 ^F		
	05.04-04.07	55		Fg.-Nr. 6Y..4..110 000→			0 265 234 363 ^T		
	05.05-04.07	55		Fg.-Nr. 6Y..5..391 601→			0 265 231 436 ^B		
							0 265 231 717 ^F		
	10.05-04.07	51					0 265 231 436 ^B		
	59					0 265 231 717 ^F			
1.9 SDI	09.99-04.04	47		Fg.-Nr. →6Y..4..109 999			0 265 224 013 ^F		
							0 265 234 717 ^T		
	05.04-04.05	47		Fg.-Nr. 6Y..4..110 000→6Y..5..391 600			0 265 231 436 ^B		
							0 265 231 717 ^F		
	05.04-03.08	47		Fg.-Nr. 6Y..4..110 000→			0 265 234 363 ^T		
05.05-03.08	47		Fg.-Nr. 6Y..5..391 601→			0 265 231 436 ^B			
						0 265 231 717 ^F			
1.9 TDI	09.99-04.04	74		Fg.-Nr. →6Y..4..109 999			0 265 224 013 ^F		
							0 265 234 717 ^T		
	05.04-04.05	74		Fg.-Nr. 6Y..4..110 000→6Y..5..391 600			0 265 231 436 ^B		
							0 265 231 717 ^F		
	05.04-10.05	74		Fg.-Nr. 6Y..4..110 000→			0 265 234 363 ^T		
	05.05-10.05	74		Fg.-Nr. 6Y..5..391 601→			0 265 231 436 ^B		
							0 265 231 717 ^F		
	10.05-11.06	74		Fg.-Nr. →6Y..74111 824			0 265 234 700 ^T		
10.05-04.07	74					0 265 231 717 ^F			
						0 265 234 119 ^T			
12.06-04.07	74		Fg.-Nr. 6Y..74119 348→			0 265 234 700 ^T			
1.9 TDIRS	06.03-04.04	96		Fg.-Nr. →6Y..4..109 999			0 265 224 013 ^F		
							0 265 234 717 ^T		
	05.04-04.05	96		Fg.-Nr. 6Y..4..110 000→6Y..5..391 600			0 265 231 436 ^B		
							0 265 231 717 ^F		
	05.04-10.05	96		Fg.-Nr. 6Y..4..110 000→			0 265 234 363 ^T		
05.05-10.05	96		Fg.-Nr. 6Y..5..391 601→			0 265 231 436 ^B			
						0 265 231 717 ^F			



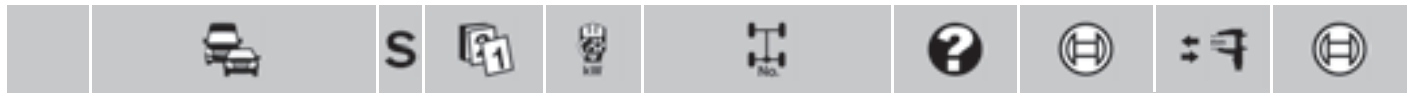

SKODA Fabia Schrägheck [6Y2]

1.9 TDI RS	10.05-11.05	96	Fg.-Nr. →6Y..6..526 417	0 265 234 363 ^T	
	10.05-04.07	96		0 265 231 717 ^F	
	12.05-11.06	96	Fg.-Nr. 6Y..64526 418→6Y..74119 347	0 265 234 700 ^T	
	12.06-04.07	96	Fg.-Nr. 6Y..74119 348→	0 265 234 700 ^T	
2.0	07.00-04.04	85	Fg.-Nr. →6Y..4..109 999	0 265 224 013 ^F	
				0 265 234 717 ^T	
	05.04-04.05	85	Fg.-Nr. 6Y..4..110 000→6Y..5..391 600	0 265 231 436 ^B	
				0 265 231 717 ^F	
	05.04-04.07	85	Fg.-Nr. 6Y..4..110 000→	0 265 234 363 ^T	
	05.05-04.07	85	Fg.-Nr. 6Y..5..391 601→	0 265 231 436 ^B	
				0 265 231 717 ^F	
1.0	09.99-08.02	37		0 265 005 252	
	1.2	07.01-04.04	40/47	Fg.-Nr. →6Y..4..115 000	0 265 005 252
	05.04-04.07	40/47		0 265 005 692	
1.4	09.99-05.03	44/50		0 265 005 252	
	09.99-08.03	55		0 265 005 252	
		74		0 265 005 252	
	09.00-04.04	55	Fg.-Nr. →6Y..4..115 000	0 265 005 252	
		74	Fg.-Nr. →6Y..4..115 000	0 265 005 252	
	05.04-04.07	55		0 265 005 692	
		74	Fg.-Nr. 6Y..4..115 001→	0 265 005 692	
1.4 TDI	05.03-04.04	55	Fg.-Nr. →6Y..4..115 000	0 265 005 252	
	05.04-04.07	55	Fg.-Nr. 6Y..4..115 001→	0 265 005 692 ^B	
	10.05-04.07	51/59		0 265 005 692	
1.9 SDI, TDI, TDI RS	09.99-04.04	47/74/96	Fg.-Nr. →6Y..4..115 000	0 265 005 252	
	05.04-03.08	47/74/96	Fg.-Nr. 6Y..4..115 001→	0 265 005 692	
2.0	07.00-04.04	85	Fg.-Nr. →6Y..4..115 000	0 265 005 252	
	05.04-04.07	85	Fg.-Nr. 6Y..4..115 001→	0 265 005 692	









Fabia [5J2]

1.2	ABO	12.06-02.10	44/51	PR-Code 1LB, PR-Code 1LM	LLE	0 204 024 227	20,64
				PR-Code 1LQ, PR-Code 1LN, PR-Code 1LR	JBH,LLE	0 986 480 850	20,6
	ABS	12.06-02.10	44/51	PR-Code 1LN, PR-Code 1LQ, PR-Code 1LR, PR-Code 1AT	JBH,LLE	0 986 480 820	20,6
1.4	ABS	01.07-03.10	63		JBH	0 986 480 820	20,6
				PR-Code 1LN, PR-Code 1LQ, PR-Code 1LR, PR-Code 1AT	JBH,LLE	0 986 480 820	20,6
1.4	ABO	01.07-03.10	51/59/63	PR-Code 1LB, PR-Code 1LM	LLE	0 204 024 227	20,64
1.4 TDI				PR-Code 1LQ, PR-Code 1LN, PR-Code 1LR	JBH,LLE	0 986 480 850	20,6
1.4 TDI	ABS	01.07-03.10	51/59	PR-Code 1LN, PR-Code 1LQ, PR-Code 1LR, PR-Code 1AT	JBH,LLE	0 986 480 820	20,6
1.6	ABO	04.07-02.10	77	PR-Code 1LB, PR-Code 1LM	LLE	0 204 024 227	20,64
				PR-Code 1LQ, PR-Code 1LN, PR-Code 1LR	JBH,LLE	0 986 480 850	20,6
				PR-Code 1LN, PR-Code 1LQ, PR-Code 1LR, PR-Code 1AT	JBH,LLE	0 986 480 820	20,6
		04.07-07.10	77		JBH	0 986 480 820	20,6
1.9 TDI	ABO	04.07-03.10	77	PR-Code 1LB, PR-Code 1LM	LLE	0 204 024 227	20,64
				PR-Code 1LQ, PR-Code 1LN, PR-Code 1LR	JBH,LLE	0 986 480 850	20,6
				PR-Code 1LN, PR-Code 1LQ, PR-Code 1LR, PR-Code 1AT	JBH,LLE	0 986 480 820	20,6
1.2		12.06-12.14	44/51			0 986 486 060	15,87
1.4, TDI		01.07-03.10	51/59/63			0 986 486 060	15,87
1.6		04.07-07.10	77			0 986 486 060	15,87
1.9 TDI		04.07-03.10	77			0 986 486 060	15,87

		S								
	1.2	12.06-11.11	44	PR-Code OEJ			0 986 486 553	19,05		
				PR-Code OEM			0 986 486 554	19,05		
		01.07-12.14	51	PR-Code OEJ			0 986 486 553	19,05		
				PR-Code OEM			0 986 486 554	19,05		
		11.11-12.14	44			MQ0	0 986 486 554	19,05		
						MQ2	0 986 486 553	19,05		
	1.2	03.10-12.14	55/63/77	PR-Code OEJ		MQ2	0 986 486 553	19,05		
	1.2 TDI			PR-Code OEM		MQ0	0 986 486 554	19,05		
	1.4	01.07-03.10	63	PR-Code OEJ			0 986 486 553	19,05		
				PR-Code OEM			0 986 486 554	19,05		
	03.10-12.14	63				0 986 486 554	19,05			
1.4 TDI	01.07-03.10	51/59	PR-Code OEJ			0 986 486 553	19,05			
			PR-Code OEM			0 986 486 554	19,05			
1.4 TSI RS	05.12-12.14	132	PR-Code OEJ		MQ2	0 986 486 553	19,05			
			PR-Code OEM		MQ0	0 986 486 554	19,05			
1.6	04.07-07.10	77	PR-Code OEJ			0 986 486 553	19,05			
			PR-Code OEM			0 986 486 554	19,05			
	06.10-12.14	77				0 986 486 554	19,05			
1.6 TDI	04.10-12.14	55	PR-Code OEJ		MQ2	0 986 486 553	19,05			
			PR-Code OEM		MQ0	0 986 486 554	19,05			
1.9 TDI	04.07-03.10	77	PR-Code OEJ			0 986 486 553	19,05			
			PR-Code OEM			0 986 486 554	19,05			
	1.2	12.06-05.09	44/51			TW	0 204 031 681 ^A			
							0 204 031 682 ^A			
	1.4	01.07-03.10	51/59/63			TW	0 204 031 681 ^A			
	1.4 TDI						0 204 031 682 ^A			
	1.6	04.07-07.10	77			TW	0 204 031 681 ^A			
							0 204 031 682 ^A			
1.9 TDI	04.07-03.10	77			TW	0 204 031 681 ^A				
							0 204 031 682 ^A			
	1.2	12.06-05.09	44/51			RDK	0 265 232 281 ^B			
			12.06-02.10	44/51			RDK	0 265 232 278 ^B		
			12.06-11.11	44/51			RDK	0 265 232 284 ^F		
								0 265 234 714 ^T		
							RDK	0 265 232 287 ^F		
								0 265 234 717 ^T		
		01.07-02.10	51			RDK	0 265 232 284 ^F			
							0 265 234 714 ^T			
						RDK	0 265 232 281 ^B			
							0 265 232 287 ^F			
							0 265 234 717 ^T			
	1.4	01.07-02.10	51/59/63			RDK	0 265 232 278 ^B			
	1.4 TDI						0 265 232 284 ^F			
						RDK	0 265 232 281 ^B			
							0 265 232 287 ^F			
							0 265 234 717 ^T			
	1.6	04.07-02.10	77			RDK	0 265 232 278 ^B			
							0 265 232 284 ^F			
							0 265 234 714 ^T			
						RDK	0 265 232 281 ^B			
						0 265 232 287 ^F				
						0 265 234 717 ^T				
1.9 TDI	04.07-02.10	77			RDK	0 265 232 278 ^B				
						0 265 232 284 ^F				
						0 265 234 714 ^T				
					RDK	0 265 232 281 ^B				
						0 265 232 287 ^F				
						0 265 234 717 ^T				













◀ SKODA Fabia [5J2]										
	1.2		12.06-12.14	44/51				0 265 005 692		
	1.4, TDI		01.07-03.10	51/59/63				0 265 005 692		
	1.6		04.07-07.10	77				0 265 005 692		
	1.9 TDI		04.07-03.10	77				0 265 005 692		
Fabia [6Y3]										
	1.2	ABO	08.02-11.04	40/47				0 204 024 227	20,64	
	1.4	ABO	09.99-12.07	74			JBH	0 986 480 850	20,6	
		ABS	09.99-12.07	74				0 986 480 820	20,6	
	1.4, TDI	ABO	09.99-12.07	44/50/51/55/59				0 204 024 227	20,64	
	1.9 SDI	ABO	09.99-12.07	47				0 204 024 227	20,64	
	1.9 TDI	ABO	09.99-12.07	74			JBH	0 986 480 850	20,6	
		ABS	09.99-12.07	74				0 986 480 820	20,6	
	2.0	ABO	07.00-12.07	85			JBH	0 986 480 850	20,6	
		ABS	07.00-12.07	85				0 986 480 820	20,6	
		1.2		08.02-11.04	40/47				0 986 486 060	15,87
1.4, TDI			09.99-12.07	44/50/51/55/59/74				0 986 486 060	15,87	
1.9 SDI, TDI			09.99-12.07	47/74				0 986 486 060	15,87	
2.0			07.00-12.07	85				0 986 486 060	15,87	
	1.2		08.02-11.04	40/47	PR-Code OEJ			0 986 486 553	19,05	
		PR-Code OEK					0 986 486 577	19,05		
		PR-Code OEM					0 986 486 554	19,05		
	1.4		09.99-12.07	44/50/51/55/59/74	PR-Code OEJ			0 986 486 553	19,05	
		PR-Code OEK					0 986 486 577	19,05		
	1.4 TDI				PR-Code OEM			0 986 486 554	19,05	
							0 986 486 554	19,05		
	1.9 SDI		09.99-12.07	47/74	PR-Code OEJ			0 986 486 553	19,05	
	1.9 TDI				PR-Code OEK			0 986 486 577	19,05	
					PR-Code OEM			0 986 486 554	19,05	
							0 986 486 554	19,05		
	2.0		07.00-12.07	85	PR-Code OEJ			0 986 486 553	19,05	
		PR-Code OEK					0 986 486 577	19,05		
		PR-Code OEM					0 986 486 554	19,05		
	1.2		08.02-11.04	40/47				0 204 031 682 ^A		
	1.4		09.99-05.03	44/50				0 204 031 682 ^A		
			09.99-05.04	55				0 204 031 682 ^A		
			05.04-12.07	55				0 204 031 681 ^A		
	1.4, TDI		09.99-12.07	59/74				0 204 031 682 ^A		
	1.4 TDI		05.03-10.05	55				0 204 031 682 ^A		
			10.05-12.07	51				0 204 031 682 ^A		
	1.9 SDI		09.99-12.07	47				0 204 031 682 ^A		
	1.9 TDI		09.99-10.05	74				0 204 031 682 ^A		
			10.05-12.07	74				0 204 031 681 ^A		
			07.00-12.07	85				0 204 031 682 ^A		
		1.2		08.02-05.04	40				0 265 224 013 ^F	
				02.03-04.04	47	Fg.-Nr. →6Y..4..109 999				0 265 234 717 ^T
									0 265 224 013 ^F	
									0 265 234 717 ^T	
			05.04-11.04	47	Fg.-Nr. 6Y..4..110 000→				0 265 231 436 ^B	
								0 265 231 717 ^F		
1.4									0 265 234 363 ^I	
			09.99-05.03	44/50					0 265 224 013 ^F	
									0 265 234 717 ^T	
			09.99-08.03	74					0 265 224 013 ^F	
									0 265 234 717 ^T	
			09.99-05.04	55				0 265 224 013 ^F		
								0 265 234 717 ^T		

		S										
1.4		09.00-04.04	74	Fg.-Nr. →6Y..4..109 999			0 265 224 013 ^F					
							0 265 234 717 ^T					
							05.04-04.05	55	Fg.-Nr. →6Y..5..391 600	0 265 231 436 ^B		
										0 265 231 717 ^F		
								74	Fg.-Nr. 6Y..4..110 000→6Y..5..391 600	0 265 231 436 ^B		
										0 265 231 717 ^F		
							05.04-12.07	55		0 265 234 363 ^T		
										74	Fg.-Nr. 6Y..4..110 000→	0 265 234 363 ^T
							05.05-12.07	55	Fg.-Nr. 6Y..5..391 601→	0 265 231 436 ^B		
										74	Fg.-Nr. 6Y..5..391 601→	0 265 231 436 ^B
			0 265 231 717 ^F									
1.4		10.05-12.07	59				0 265 231 436 ^B					
1.4 TDI							0 265 231 717 ^F					
							0 265 234 363 ^T					
1.4 TDI		05.03-04.04	55	Fg.-Nr. →6Y..4..109 999			0 265 224 013 ^F					
							0 265 234 717 ^T					
							05.04-04.05	55	Fg.-Nr. 6Y..4..110 000→6Y..5..391 600	0 265 231 436 ^B		
										0 265 231 717 ^F		
							05.04-10.05	55	Fg.-Nr. 6Y..4..110 000→	0 265 234 363 ^T		
							05.05-10.05	55	Fg.-Nr. 6Y..5..391 601→	0 265 231 436 ^B		
										0 265 231 717 ^F		
							10.05-12.07	51		0 265 231 436 ^B		
										0 265 231 717 ^F		
										0 265 234 363 ^T		
1.9 SDI		09.99-04.04	47	Fg.-Nr. →6Y..4..109 999			0 265 224 013 ^F					
							0 265 234 717 ^T					
							05.04-04.05	47	Fg.-Nr. 6Y..4..110 000→6Y..5..391 600	0 265 231 436 ^B		
										0 265 231 717 ^F		
							05.04-12.07	47	Fg.-Nr. 6Y..4..110 000→	0 265 234 363 ^T		
							05.05-12.07	47	Fg.-Nr. 6Y..5..391 601→	0 265 231 436 ^B		
0 265 231 717 ^F												
1.9 TDI		09.99-04.04	74	Fg.-Nr. →6Y..4..109 999			0 265 224 013 ^F					
							0 265 234 717 ^T					
							05.04-04.05	74	Fg.-Nr. 6Y..4..110 000→6Y..5..391 600	0 265 231 436 ^B		
										0 265 231 717 ^F		
							05.04-10.05	74	Fg.-Nr. 6Y..4..110 000→	0 265 234 363 ^T		
							05.05-10.05	74	Fg.-Nr. 6Y..5..391 601→	0 265 231 436 ^B		
										0 265 231 717 ^F		
							10.05-12.07	74		0 265 231 717 ^F		
										0 265 234 119 ^T		
										0 265 234 700 ^T		
2.0		07.00-04.04	85	Fg.-Nr. →6Y..4..109 999			0 265 224 013 ^F					
							0 265 234 717 ^T					
							05.04-04.05	85	Fg.-Nr. 6Y..4..110 000→6Y..5..391 600	0 265 231 436 ^B		
										0 265 231 717 ^F		
							05.04-12.07	85	Fg.-Nr. 6Y..4..110 000→	0 265 234 363 ^T		
05.05-12.07	85	Fg.-Nr. 6Y..5..391 601→	0 265 231 436 ^B									
			0 265 231 717 ^F									
1.2		08.02-04.04	40/47	Fg.-Nr. →6Y..4..115 000			0 265 005 252					
		05.04-11.04	40/47	Fg.-Nr. 6Y..4..115 001→			0 265 005 692					
1.4		09.99-05.03	44/50				0 265 005 252					
							0 265 005 252					
		09.99-08.03	55						0 265 005 252			
									74			0 265 005 252
		09.00-04.04	55	Fg.-Nr. →6Y..4..115 000					0 265 005 252			
									74	Fg.-Nr. →6Y..4..115 000	0 265 005 252	
		05.04-12.07	55						0 265 005 692			
74	Fg.-Nr. 6Y..4..115 001→								0 265 005 692			
1.4 TDI		05.03-04.04	55	Fg.-Nr. →6Y..4..115 000			0 265 005 252					
		05.04-10.05	55	Fg.-Nr. 6Y..4..115 001→			0 265 005 692					
		10.05-12.07	51				0 265 005 692					
			59				0 265 005 692					



		S								
◀ SKODA Fabia [6Y3]										
	1.9 SDI		09.99-04.04	47/74	Fg.-Nr. →6Y..4..115 000			0 265 005 252		
	1.9 TDI		05.04-12.07	47/74	Fg.-Nr. 6Y..4..115 001→			0 265 005 692		
	2.0		07.00-04.04	85	Fg.-Nr. →6Y..4..115 000			0 265 005 252		
			05.04-12.07	85	Fg.-Nr. 6Y..4..115 001→			0 265 005 692		
Favorit										
	135		09.88-09.94	40/43				0 986 480 683	22,2	
		136, i.e.		09.88-12.98	40/46/50			0 986 480 683	22,2	
Felicia Combi [6U5]										
	1.3	ABO	10.94-08.01	40/42/43/50		JBH		0 986 480 682	22,2	
		1.3 i	ABS	10.94-08.01	40/42/43/50		JBH		0 986 481 014	23,81
	1.6 i	ABO	10.95-08.01	55		JBH		0 986 480 682	22,2	
			ABS	10.95-08.01	55		JBH		0 986 481 014	23,81
	1.9 D	ABO	10.95-08.01	47		JBH		0 986 480 682	22,2	
			ABS	10.95-08.01	47		JBH		0 986 481 014	23,81
Felicia Fun [6UF]										
	1.3		08.96-03.01	50		JBH		0 986 480 682	22,2	
		1.6		08.96-03.01	55		JBH		0 986 480 682	22,2
		1.9 D		08.96-03.01	47		JBH		0 986 480 682	22,2
	1.3		08.96-03.01	50				0 986 482 007 ^A		
		1.6		08.96-03.01	55			0 986 482 007 ^A		
Felicia [6U1]										
	1.3	ABO	10.94-08.01	40/42/43/50		JBH		0 986 480 682	22,2	
		1.3 i	ABS	10.94-08.01	40/42/43/50		JBH		0 986 481 014	23,81
	1.6 i	ABO	05.95-08.01	55		JBH		0 986 480 682	22,2	
			ABS	05.95-08.01	55		JBH		0 986 481 014	23,81
	1.9 D	ABO	10.95-08.01	47		JBH		0 986 480 682	22,2	
			ABS	10.95-08.01	47		JBH		0 986 481 014	23,81
Forman										
	1.1		10.90-12.95	38				0 986 480 683	22,2	
		1.3, i.e.		10.90-12.95	40/45/50			0 986 480 683	22,2	
Octavia Combi										
	2.0 TDI		05.13→	105	PR-Code OEC, PR-Code OEM	MQO		0 986 486 554	19,05	
Octavia Combi [1U5]										
	1.4	OFD	08.00-04.01	55	Fg.-Nr. →1U..1..530 143, →1U..18530 069	LLE		F 026 003 339	23,81	
				08.00-12.10	55		RLE		0 204 123 406	23,81
	1.6	OFD	02.97-04.01	55/74/75	Fg.-Nr. →1U..1..530 143, →1U..18530 069	LLE		F 026 003 339	23,81	
				02.97-12.10	55/74/75		RLE		0 204 123 406	23,81

		S							
1.8	OFD	10.96-04.99	92				LLE	F 026 003 339	23,81
							RLE	0 204 123 406	23,81
1.8 RS	OFD	01.03-01.06	132				RLE	0 204 123 406	23,81
1.8 T	OFD	03.98-04.01	110			Fg.-Nr. →1U..1..530 143, →1U..18530 069	LLE	F 026 003 339	23,81
1.8 T 4x4			03.98-12.10	110			RLE	0 204 123 406	23,81
			01.00-07.00	110			LLE	F 026 003 339	23,81
1.9 SDI	OFD	05.97-07.00	50				LLE	F 026 003 339	23,81
							RLE	0 204 123 406	23,81
							LLE	F 026 003 339	23,81
1.9 TDI	OFD	01.03-09.04	96				RLE	0 204 123 406	23,81
							RLE	0 204 123 406	23,81
1.9 TDI 4x4	OFD	08.97-04.01	66/74/81			Fg.-Nr. →1U..1..530 143, →1U..18530 069	LLE	F 026 003 339	23,81
							RLE	0 204 123 406	23,81
2.0	OFD	08.00-04.01	85			Fg.-Nr. →1U..1..530 143, →1U..18530 069	LLE	F 026 003 339	23,81
							RLE	0 204 123 406	23,81
 1.4	OFD	08.00-12.10	55				LLE	0 204 125 717	
							RLE	0 204 125 505	
							RLE	0 204 125 719	
							RLE	0 204 125 719	
1.6	OFD	02.97-12.10	55/74/75				LLE	0 204 125 717	
							RLE	0 204 125 505	
							RLE	0 204 125 719	
							RLE	0 204 125 719	
1.8	ABO,	10.96-12.10	92/110/				LLE	0 204 125 717	
							LLE	0 204 125 717	
1.8 RS	OFD		132				LLE	0 204 125 717	
1.8 T	ABS,	10.96-12.10	92/110/				RLE	0 204 125 505	
							RLE	0 204 125 719	
1.8 T 4x4	ASR	10.96-12.10	92/110/				RLE	0 204 125 719	
							RLE	0 204 125 719	
1.9 SDI	ABO,	05.97-12.10	50/66/74/				LLE	0 204 125 717	
1.9 TDI	OFD	05.97-12.10	50/66/74/				LLE	0 204 125 717	
							LLE	0 204 125 717	
1.9 TDI 4x4	ABS,	05.97-12.10	50/66/74/				RLE	0 204 125 505	
							RLE	0 204 125 719	
2.0	OFD	08.00-01.06	85				LLE	0 204 125 717	
							LLE	0 204 125 717	
2.0 4x4	ABS,	08.00-01.06	85				RLE	0 204 125 505	
							RLE	0 204 125 719	
 1.4	OFD	08.00-12.10	55				LLE	0 986 486 031	15,87
							RLE	0 986 486 060	15,87
1.6	OFD	02.97-12.10	55/74/75				LLE	0 986 486 031	15,87
							RLE	0 986 486 060	15,87
1.8, RS, T, T 4x4	OFD	10.96-12.10	92/110/				LLE	0 986 486 031	15,87
							RLE	0 986 486 060	15,87
1.9 SDI, TDI, TDI 4x4	OFD	05.97-12.10	50/66/74/				LLE	0 986 486 031	15,87
							RLE	0 986 486 060	15,87
2.0	OFD	08.00-01.06	85				LLE	0 986 486 031	15,87
							LLE	0 986 486 031	15,87
2.0 4x4	OFD	11.99-12.00	88				RLE	0 986 486 060	15,87
							RLE	0 986 486 060	15,87

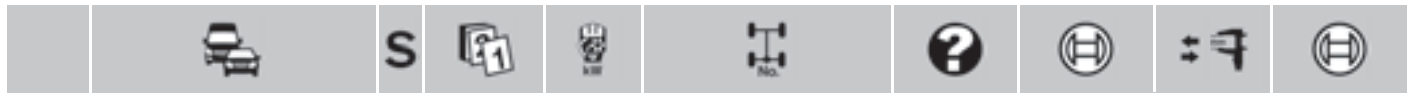















◀ SKODA Octavia Combi [1U5]

	1.4	08.00-12.10	55	FSG	0 986 486 542	23,81
				FSZ	0 986 486 538	19
	1.6	02.97-12.10	55/74/75	FSG	0 986 486 542	23,81
				FSZ	0 986 486 538	19
	1.8, RS, T, T 4x4	10.96-12.10	92/110/ 132	FSG	0 986 486 542	23,81
				FSZ	0 986 486 538	19
	1.9 SDI, TDI, TDI 4x4	05.97-03.10	50/66	FSG	0 986 486 542	23,81
				FSZ	0 986 486 538	19
	1.9 TDI	08.97-01.06	81	FSG	0 986 486 542	23,81
				FSZ	0 986 486 538	19
	08.00-09.04	74	FSG	0 986 486 542	23,81	
	01.03-09.04	96		0 986 486 595	29	
			FSG	0 986 486 542	23,81	
			FSZ	0 986 486 538	19	
	10.05-12.10	74	FSG	0 986 486 542	23,81	
	1.9 TDI, TDI 4x4	08.00-12.10	74	FSZ	0 986 486 538	19
	1.9 TDI 4x4	08.00-01.06	74		0 986 486 595	29
				FSG	0 986 486 542	23,81
	2.0	08.00-01.06	85	FSG	0 986 486 542	23,81
	2.0 4x4			FSZ	0 986 486 538	19
	2.0 4x4	11.99-12.00	88	FSG	0 986 486 542	23,81













Octavia Combi [1Z5]

	1.2 TSI	02.10-06.13	77	JBH, LLE	0 986 480 870	22
	1.4	05.04-06.06	55	LLE BO	F 026 003 715	22,2
				JBH, LLE ATE	0 986 480 870	22
05.06-06.13		59	LLE BO	F 026 003 715	22,2	
				JBH, LLE ATE	0 986 480 870	22
		11.10-06.13	59	JBH, LLE	0 986 480 870	22
	1.4 TSI	11.08-06.13	90	JBH, LLE	0 986 480 870	22
	1.6	05.04-06.13	75	LLE BO	F 026 003 715	22,2
				JBH, LLE ATE	0 986 480 870	22
		08.09-06.13	75	JBH, LLE	0 986 480 870	22
	1.6 FSI	05.04-10.08	85	LLE BO	F 026 003 715	22,2
				JBH, LLE ATE	0 986 480 870	22
	1.6 TDI, TDI 4x4	06.09-04.13	77	JBH, LLE	0 986 480 870	22
	1.8 TSI	06.07-10.08	118	LLE BO	F 026 003 715	22,2
				JBH, LLE ATE	0 986 480 870	22
		11.08-06.13	118	JBH, LLE	0 986 480 870	22
	1.8 TSI, TSI 4x4	03.09-06.13	112	JBH, LLE	0 986 480 870	22
	1.8 TSI 4x4	11.08-06.13	118	JBH, LLE	0 986 480 870	22
	1.9 TDI	05.04-04.13	77	LLE BO	F 026 003 715	22,2
	1.9 TDI 4x4			JBH, LLE ATE	0 986 480 870	22
	2.0 FSI	11.04-10.08	110	LLE BO	F 026 003 715	22,2
	2.0 FSI 4x4			JBH, LLE ATE	0 986 480 870	22
	2.0 TDI	05.04-05.10	100	LLE BO	F 026 003 715	22,2
				JBH, LLE ATE	0 986 480 870	22
	2.0 TDI	05.04-05.10	103	LLE BO	F 026 003 715	22,2
	2.0 TDI 4x4			JBH, LLE ATE	0 986 480 870	22
		02.10-05.13	103	JBH, LLE	0 986 480 870	22
		03.10-06.13	81	JBH, LLE	0 986 480 870	22

	1.4	05.04-06.13	55/59	LLE BO	0 204 055 051	
	1.6, FSI	05.04-06.13	75/85	LLE BO	0 204 055 051	



















		S							
1.8 TSI		06.07-10.08	118			LLE	BO	0 204 055 051	
1.9 TDI, TDI 4x4		05.04-04.13	77			LLE	BO	0 204 055 051	
2.0 FSI, FSI 4x4, TDI, TDI 4x4		05.04-05.10	100/103/110			LLE	BO	0 204 055 051	
 1.2 TSI		02.10-06.13	77	PR-Code OEM		MQ0		0 986 486 554	19,05
1.4		05.04-06.06	55					0 986 486 576	19
		05.06-06.13	59					0 986 486 576	19
		11.10-06.13	59	PR-Code OEJ		MQ2		0 986 486 576	19
				PR-Code OEM		MQ0		0 986 486 554	19,05
1.4 TSI		11.08-06.13	90	PR-Code OEM		MQ0		0 986 486 554	19,05
1.6		05.04-06.13	75					0 986 486 576	19
		08.09-06.13	75					0 986 486 554	19,05
1.6 FSI		05.04-10.08	85					0 986 486 576	19
1.8 TSI		06.07-10.08	118					0 986 486 576	19
		05.09-06.13	112	PR-Code OEM		MQ0		0 986 486 554	19,05
1.8 TSI, TSI 4x4		11.08-06.13	118	PR-Code OEM		MQ0		0 986 486 554	19,05
1.8 TSI 4x4		03.09-06.13	112	PR-Code OEM				0 986 486 554	19,05
2.0 FSI, FSI 4x4		11.04-10.08	110					0 986 486 576	19
2.0 RS		10.05-10.08	147					0 986 486 576	19
2.0 TDI RS		05.08-02.13	125					0 986 486 595	29
2.0 TDI, TDI 4x4		02.10-06.13	81/103	PR-Code OEM		MQ0		0 986 486 554	19,05
Octavia Combi [5E5]									
									
 1.2 TSI		11.12→	63/77	PR-Code OEC, PR-Code OEM		MQ0		0 986 486 554	19,05
1.4 TSI, TSI G-Tec		11.12→	81/103	PR-Code OEC, PR-Code OEM		MQ0		0 986 486 554	19,05
1.6, TDI, TDI 4x4		11.12→	66/77/81	PR-Code OEC, PR-Code OEM		MQ0		0 986 486 554	19,05
1.8 TDI 4x4, TSI, TSI 4x4		11.12→	132	PR-Code OEC, PR-Code OEM		MQ0		0 986 486 554	19,05
2.0 FSI RS, TDI, TDI 4x4		11.12→	105/110/ 135/162	PR-Code OEC, PR-Code OEM		MQ0		0 986 486 554	19,05
Octavia RS Combi [5E5]									
									
 2.0 FSI		05.13→	135	PR-Code OEC, PR-Code OEM		MQ0		0 986 486 554	19,05
Octavia [1U2]									
									
 1.4		OFD 06.99-01.02	44/55			LLE		F 026 003 339	23,81
		06.99-12.10	44/55			RLE		0 204 123 406	23,81
1.6		OFD 09.96-04.01	55/74/75	Fg.-Nr. →1U..1..530 143, →1U..18530 069		LLE		F 026 003 339	23,81
		09.96-12.10	55/74/75			RLE		0 204 123 406	23,81
1.8		OFD 09.96-04.99	92			LLE		F 026 003 339	23,81
						RLE		0 204 123 406	23,81
1.8 RS		OFD 08.00-04.01	132	Fg.-Nr. →1U..1..530 143, →1U..18530 069		LLE		F 026 003 339	23,81
		08.00-09.04	132			RLE		0 204 123 406	23,81
1.8 T		OFD 03.98-04.01	110	Fg.-Nr. →1U..1..530 143, →1U..18530 069		LLE		F 026 003 339	23,81
1.8 T 4x4						RLE		0 204 123 406	23,81
		01.00-07.00	110			LLE		F 026 003 339	23,81
1.9 SDI		OFD 05.97-07.00	50			LLE		F 026 003 339	23,81
		05.97-12.03	50			RLE		0 204 123 406	23,81
		08.00-04.01	50	Fg.-Nr. →1U..1..530 143, →1U..18530 069		LLE		F 026 003 339	23,81
1.9 TDI		OFD 09.96-04.01	66	Fg.-Nr. →1U..1..530 143, →1U..18530 069		LLE		F 026 003 339	23,81
		09.96-03.10	66			RLE		0 204 123 406	23,81

		S							
◀ SKODA Octavia [1U2]									
1.9 TDI	OFD	05.97-04.01	81	Fg.-Nr. →1U..1.530 143, →1U..18530 069		LLE	F 026 003 339	23,81	
		05.97-01.06	81			RLE	0 204 123 406	23,81	
		01.03-09.04	96			RLE	0 204 123 406	23,81	
		10.05-12.10	74			RLE	0 204 123 406	23,81	
		06.99-04.01	85	Fg.-Nr. →1U..1.530 143, →1U..18530 069		LLE	F 026 003 339	23,81	
2.0, i, 4x4	OFD	06.99-04.01	85	Fg.-Nr. →1U..1.530 143, →1U..18530 069		LLE	F 026 003 339	23,81	
		06.99-05.07	85			RLE	0 204 123 406	23,81	
1.4	ABO, OFD	06.99-12.10	44/55			LLE	0 204 125 717		
	ABS, ASR	06.99-12.10	44/55			RLE	0 204 125 505		
	ABS, OFD	06.99-12.10	44/55			RLE	0 204 125 719		
		06.99-12.10	44/55			RLE	0 204 125 719		
1.6	ABO, OFD	09.96-12.10	55/74/75			LLE	0 204 125 717		
	ABS, ASR	09.96-12.10	55/74/75			RLE	0 204 125 505		
	ABS, OFD	09.96-12.10	55/74/75			RLE	0 204 125 719		
		09.96-12.10	55/74/75			RLE	0 204 125 719		
1.8	ABO, OFD	09.96-12.10	92/110/ 132			LLE	0 204 125 717		
1.8 RS	OFD		132			LLE			
1.8 T	ABS, ASR	09.96-12.10	92/110/ 132			RLE	0 204 125 505		
1.8 T 4x4	ABS, OFD	09.96-12.10	92/110/ 132			RLE	0 204 125 719		
1.9 SDI	ABO, OFD	09.96-12.10	50/66/74/ 81/96			LLE	0 204 125 717		
1.9 TDI	OFD		81/96			LLE			
	ABS, ASR	09.96-12.10	50/66/74/ 81/96			RLE	0 204 125 505		
	ABS, OFD	09.96-12.10	50/66/74/ 81/96			RLE	0 204 125 719		
		09.96-12.10	50/66/74/ 81/96			RLE	0 204 125 719		
2.0	ABO, OFD	06.99-05.07	85			LLE	0 204 125 717		
2.0 i	OFD					LLE			
2.0 4x4	ABS, ASR	06.99-05.07	85			RLE	0 204 125 505		
	ABS, OFD	06.99-05.07	85			RLE	0 204 125 719		
		06.99-05.07	85			RLE	0 204 125 719		
1.4		06.99-12.10	44/55			LLE	0 986 486 031	15,87	
						RLE	0 986 486 060	15,87	
1.6		09.96-12.10	55/74/75			LLE	0 986 486 031	15,87	
						RLE	0 986 486 060	15,87	
1.8, RS, T, T 4x4		09.96-12.10	92/110/ 132			LLE	0 986 486 031	15,87	
						RLE	0 986 486 060	15,87	
1.9 SDI		09.96-12.10	50/66/74/ 81/96			LLE	0 986 486 031	15,87	
1.9 TDI			81/96			RLE	0 986 486 060	15,87	
2.0, i, 4x4		06.99-05.07	85			LLE	0 986 486 031	15,87	
						RLE	0 986 486 060	15,87	
1.4		06.99-03.01	44				0 986 486 577	19,05	
		08.00-12.10	55			FSG	0 986 486 542	23,81	
1.6						FSZ	0 986 486 538	19	
		09.96-12.10	55/74/75			FSG	0 986 486 542	23,81	
1.8, RS, T, T 4x4						FSZ	0 986 486 538	19	
		09.96-12.10	92/110/ 132			FSG	0 986 486 542	23,81	
1.9 SDI		09.96-12.10	50/66/74/ 81			FSG	0 986 486 542	23,81	
1.9 TDI			81			FSZ	0 986 486 538	19	

















		S								
1.9 TDI		01.03-09.04	96					0 986 486 595	29	
							FSG	0 986 486 542	23,81	
							FSZ	0 986 486 538	19	
2.0, i, 4x4		06.99-05.07	85				FSG	0 986 486 542	23,81	
							FSZ	0 986 486 538	19	
	1.4	06.99-12.10	44/55			TBR	0 986 482 007 ^A			
	1.6	09.96-12.10	55/74/75			TBR	0 986 482 007 ^A			
	1.8	09.96-04.99	92			TBR	0 986 482 007 ^A			
	1.9 SDI, TDI	09.96-12.10	50/66/74/81/96			TBR	0 986 482 007 ^A			
	2.0, i	06.99-05.07	85			TBR	0 986 482 007 ^A			
Octavia [1Z3]										
										
	1.2 TSI	02.10-06.13	77			JBH, LLE	0 986 480 870		22	
	1.4	05.04-12.10	55			LLE BO	F 026 003 715		22,2	
						JBH, LLE ATE	0 986 480 870		22	
		05.06-06.13	59			LLE BO	F 026 003 715		22,2	
						JBH, LLE ATE	0 986 480 870		22	
		11.10-06.13	59			JBH, LLE	0 986 480 870		22	
	1.4 TSI	11.08-06.13	90			JBH, LLE	0 986 480 870		22	
	1.6	05.04-06.13	75			LLE BO	F 026 003 715		22,2	
						JBH, LLE ATE	0 986 480 870		22	
		08.09-06.13	75			JBH, LLE	0 986 480 870		22	
	1.6 FSI	05.04-10.08	85			LLE BO	F 026 003 715		22,2	
						JBH, LLE ATE	0 986 480 870		22	
	1.6 TDI	06.09-04.13	77			JBH, LLE	0 986 480 870		22	
	1.8 TSI	06.07-10.08	118			LLE BO	F 026 003 715		22,2	
						JBH, LLE ATE	0 986 480 870		22	
		11.08-06.13	118			JBH, LLE	0 986 480 870		22	
		03.09-06.13	112			JBH, LLE	0 986 480 870		22	
	1.9 TDI	05.04-04.13	77			LLE BO	F 026 003 715		22,2	
	1.9 TDI 4x4					JBH, LLE ATE	0 986 480 870		22	
	2.0 FSI	11.04-10.08	110			LLE BO	F 026 003 715		22,2	
	2.0 FSI 4x4					JBH, LLE ATE	0 986 480 870		22	
2.0 TDI	05.04-05.10	100			LLE BO	F 026 003 715		22,2		
					JBH, LLE ATE	0 986 480 870		22		
	103			LLE BO	F 026 003 715		22,2			
				JBH, LLE ATE	0 986 480 870		22			
	02.10-05.13	103			JBH, LLE	0 986 480 870		22		
	03.10-06.13	81			JBH, LLE	0 986 480 870		22		
2.0 TDI 4x4	05.10-05.13	103			JBH, LLE	0 986 480 870		22		
	1.4	05.04-06.13	55/59			LLE BO	0 204 055 051			
	1.6, FSI	05.04-06.13	75/85			LLE BO	0 204 055 051			
	1.8 TSI	06.07-10.08	118			LLE BO	0 204 055 051			
	1.9 TDI, TDI 4x4	05.04-04.13	77			LLE BO	0 204 055 051			
	2.0 FSI, FSI 4x4, TDI	05.04-05.10	100/103/110			LLE BO	0 204 055 051			
	1.2 TSI	02.10-06.13	77	PR-Code OEM		MQ0	0 986 486 554		19,05	
	1.4	05.04-12.10	55				0 986 486 576		19	
							0 986 486 576		19	
		05.06-06.13	59			PR-Code OEJ	MQ2	0 986 486 576		19
						PR-Code OEM	MQ0	0 986 486 554		19,05
	1.4 TSI	11.08-06.13	90	PR-Code OEM		MQ0	0 986 486 554		19,05	
	1.6	05.04-06.13	75				0 986 486 576		19	
		08.09-06.13	75				0 986 486 554		19,05	
	1.6 FSI	05.04-10.08	85				0 986 486 576		19	
	1.8 TSI	06.07-10.08	118				0 986 486 576		19	
						PR-Code OEM	MQ0	0 986 486 554		19,05
		03.09-06.13	112	PR-Code OEM		MQ0	0 986 486 554		19,05	



		S							
	◀ SKODA Octavia [1Z3]								
	2.0 FSI, FSI 4x4	11.04-10.08	110				0 986 486 576	19	
	2.0 RS	10.05-10.08	147				0 986 486 576	19	
	2.0 TDI RS	05.08-02.13	125				0 986 486 595	29	
	2.0 TDI, TDI 4x4	02.10-06.13	81/103	PR-Code OEM	MQ0		0 986 486 554	19,05	
Octavia [5E3]									
	1.2 TSI	11.12→	63/77	PR-Code OEC, PR-Code OEM	MQ0		0 986 486 554	19,05	
	1.4 TSI, TSI G-Tec	11.12→	81/103	PR-Code OEC, PR-Code OEM	MQ0		0 986 486 554	19,05	
	1.6, TDI, TDI 4x4	11.12→	66/77/81	PR-Code OEC, PR-Code OEM	MQ0		0 986 486 554	19,05	
	1.8 TSI, TSI 4x4	11.12→	132	PR-Code OEC, PR-Code OEM	MQ0		0 986 486 554	19,05	
	2.0 FSI RS, TDI, TDI RS, TDI 4x4	11.12→	105/110/ 135/162	PR-Code OEC, PR-Code OEM	MQ0		0 986 486 554	19,05	
Pick-Up [6U7]									
	1.6 MPI	ABO 10.95-03.01	55		JBH		0 986 480 682	22,2	
		ABS 10.95-03.01	55		JBH		0 986 481 014	23,81	
	1.9 D	ABO 01.96-03.01	47		JBH		0 986 480 682	22,2	
		ABS 01.96-03.01	47		JBH		0 986 481 014	23,81	
	135 MPI	ABO 08.96-03.01	40		JBH		0 986 480 682	22,2	
		ABS 08.96-03.01	40		JBH		0 986 481 014	23,81	
	136 MPI	ABO 08.96-03.01	50		JBH		0 986 480 682	22,2	
		ABS 08.96-03.01	50		JBH		0 986 481 014	23,81	
	1.6 MPI	10.95-03.01	55				0 986 482 007 ^A		
	135, i.e., MPI	09.91-03.01	40/42/43				0 986 482 007 ^A		
	136 i.e., MPI	07.93-03.01	50				0 986 482 007 ^A		
Praktik [5J7]									
	1.2	ABO 03.07-03.09	51		JBH, LLE		0 986 480 850	20,6	
		03.09-02.10	51	PR-Code 1LQ, PR-Code 1LN, PR-Code 1LR	JBH, LLE		0 986 480 850	20,6	
		ABS 03.07-03.09	51		JBH, LLE		0 986 480 820	20,6	
		03.09-02.10	51	PR-Code 1LN, PR-Code 1LQ, PR-Code 1LR, PR-Code 1AT	JBH, LLE		0 986 480 820	20,6	
	1.4	ABO 03.07-03.10	51/59/63		JBH, LLE		0 986 480 850	20,6	
	1.4 TDI	ABS 03.07-03.10	51/59/63		JBH, LLE		0 986 480 820	20,6	
	1.2	03.07-02.10	51				0 986 486 060	15,87	
	1.4, TDI	03.07-03.10	51/59/63				0 986 486 060	15,87	
	1.2	03.07-03.09	51	PR-Code OEJ			0 986 486 553	19,05	
				PR-Code OEM			0 986 486 554	19,05	
		03.09-05.15	51	PR-Code OEJ	MQ2		0 986 486 553	19,05	
				PR-Code OEM	MQ0		0 986 486 554	19,05	
	1.2 TDI	03.10-05.15	55/63	PR-Code OEJ	MQ2		0 986 486 553	19,05	
	1.2 TSI			PR-Code OEM	MQ0		0 986 486 554	19,05	
	1.4	03.07-03.10	63	PR-Code OEJ			0 986 486 553	19,05	
				PR-Code OEM			0 986 486 554	19,05	
		03.10-05.15	63	PR-Code OEJ	MQ2		0 986 486 553	19,05	
				PR-Code OEM	MQ0		0 986 486 554	19,05	
	1.4 TDI	03.07-03.10	51/59	PR-Code OEJ			0 986 486 553	19,05	
				PR-Code OEM			0 986 486 554	19,05	
	1.6 TDI	03.10-05.15	66	PR-Code OEJ	MQ2		0 986 486 553	19,05	
				PR-Code OEM	MQ0		0 986 486 554	19,05	

		S								
	1.2	03.07-01.11	51/55/63			RDK	0 265 232 278 ^B			
	1.2 TDI						0 265 234 714 ^T			
	1.2 TSI					RDK	0 265 232 281 ^B			
							0 265 234 717 ^T			
		03.07-05.15	51/55/63			RDK	0 265 232 284 ^F			
						RDK	0 265 232 287 ^F			
	1.4	03.07-01.11	51/59/63			RDK	0 265 232 278 ^B			
	1.4 TDI						0 265 234 714 ^T			
						RDK	0 265 232 281 ^B			
							0 265 234 717 ^T			
		03.07-05.15	51/59/63			RDK	0 265 232 284 ^F			
						RDK	0 265 232 287 ^F			
1.6 TDI	03.10-01.11	66			RDK	0 265 232 278 ^B				
						0 265 234 714 ^T				
					RDK	0 265 232 281 ^B				
						0 265 234 717 ^T				
	03.10-05.15	66			RDK	0 265 232 284 ^F				
					RDK	0 265 232 287 ^F				
	1.2	03.07-03.10	51				0 265 005 692			
	1.4, TDI	03.07-03.10	51/59/63				0 265 005 692			
Rapid [NA2]										
										
	1.6	09.11→	77	PR-Code 0EJ	MQ2		0 986 486 553	19,05		
	1.6 TDI			PR-Code OEM	MQ0		0 986 486 554	19,05		
Rapid [NH3]										
										
	1.2	07.12-05.15	55/63/77			MQ2	0 986 486 553	19,05		
	1.2 TSI	07.12-06.15	55/63/77			MQ0	0 986 486 554	19,05		
	1.4 TSI	07.12-05.15	90			MQ2	0 986 486 553	19,05		
		07.12-06.15	90			MQ0	0 986 486 554	19,05		
	1.6	07.12-05.15	66/77/81			MQ2	0 986 486 553	19,05		
	1.6 TDI	07.12→	66/77/81			MQ0	0 986 486 554	19,05		
	Rapid Spaceback [NH1]									
										
	1.2 TSI	10.13-05.15	63/77			MQ0	0 986 486 554	19,05		
						MQ2	0 986 486 553	19,05		
	1.4 TSI	10.13-05.15	90			MQ2	0 986 486 553	19,05		
		10.13-06.15	90			MQ0	0 986 486 554	19,05		
	1.6	10.13-05.15	66/77/81			MQ2	0 986 486 553	19,05		
	1.6 TDI	10.13→	66/77/81			MQ0	0 986 486 554	19,05		
Roomster [5J7]										
										
	1.2	ABO	05.06-01.07	47			JBH,LLE	0 986 480 850	20,6	
			01.07-03.09	51			JBH,LLE	0 986 480 850	20,6	
			03.09-02.10	51	PR-Code 1LQ, PR-Code 1LN, PR-Code 1LR		JBH,LLE	0 986 480 850	20,6	
		ABS	05.06-01.07	47			JBH,LLE	0 986 480 820	20,6	
			01.07-03.09	51			JBH,LLE	0 986 480 820	20,6	
			03.09-02.10	51	PR-Code 1LN, PR-Code 1LQ, PR-Code 1LR, PR-Code 1AT		JBH,LLE	0 986 480 820	20,6	
	1.4	ABO	05.06-03.10	51/59/63			JBH,LLE	0 986 480 850	20,6	
	1.4 TDI	ABS	05.06-03.10	51/59/63			JBH,LLE	0 986 480 820	20,6	

		S							
◀ SKODA Roomster [5J7]									
1.6	ABO	05.06-07.10	77			JBH,LLE	0986 480 850	20,6	
	ABS	05.06-07.10	77			JBH,LLE	0986 480 820	20,6	
1.9 TDI	ABO	03.06-03.10	74/77			JBH,LLE	0986 480 850	20,6	
	ABS	03.06-03.10	74/77			JBH,LLE	0986 480 820	20,6	
	1.2	05.06-02.10	47/51				0986 486 060	15,87	
	1.4, TDI	05.06-03.10	51/59/63				0986 486 060	15,87	
	1.6	05.06-07.10	77				0986 486 060	15,87	
	1.9 TDI	03.06-03.10	74/77				0986 486 060	15,87	
	1.2	05.06-01.07	47	PR-Code OEJ			0986 486 553	19,05	
				PR-Code OEM			0986 486 554	19,05	
		01.07-03.09	51	PR-Code OEJ			0986 486 553	19,05	
				PR-Code OEM			0986 486 554	19,05	
		03.09-05.15	51	PR-Code OEJ	MQ2		0986 486 553	19,05	
				PR-Code OEM	MQ0		0986 486 554	19,05	
	1.2 TDI	03.10-05.15	55/63/77	PR-Code OEJ	MQ2		0986 486 553	19,05	
	1.2 TSI			PR-Code OEM	MQ0		0986 486 554	19,05	
	1.4	05.06-03.10	63	PR-Code OEJ			0986 486 553	19,05	
				PR-Code OEM			0986 486 554	19,05	
		03.10-05.15	63	PR-Code OEJ	MQ2		0986 486 553	19,05	
				PR-Code OEM	MQ0		0986 486 554	19,05	
	1.4 TDI	05.06-03.10	51/59	PR-Code OEJ			0986 486 553	19,05	
				PR-Code OEM			0986 486 554	19,05	
	1.6	05.06-07.10	77	PR-Code OEJ			0986 486 553	19,05	
				PR-Code OEM			0986 486 554	19,05	
		06.10-05.15	77	PR-Code OEJ	MQ2		0986 486 553	19,05	
				PR-Code OEM	MQ0		0986 486 554	19,05	
	1.6 TDI	03.10-05.15	66	PR-Code OEJ	MQ2		0986 486 553	19,05	
				PR-Code OEM	MQ0		0986 486 554	19,05	
			77	PR-Code OEJ	MQ2		0986 486 553	19,05	
				PR-Code OEM	MQ0		0986 486 554	19,05	
	1.9 TDI	03.06-03.10	74/77	PR-Code OEJ			0986 486 553	19,05	
				PR-Code OEM			0986 486 554	19,05	
	1.2	05.06-01.11	47/51/55/			RDK	0 265 232 278 ^B		
	1.2 TDI		63				0 265 234 714 ^T		
	1.2 TSI					RDK	0 265 232 281 ^B		
							0 265 234 717 ^T		
		05.06-05.15	47/51/55/			RDK	0 265 232 284 ^F		
			63			RDK	0 265 232 287 ^F		
	1.2 TSI	03.10-01.11	77			RDK	0 265 232 278 ^B		
							0 265 234 714 ^T		
						RDK	0 265 232 281 ^B		
							0 265 234 717 ^T		
		03.10-05.15	77			RDK	0 265 232 287 ^F		
	1.4	05.06-01.11	51/59/63			RDK	0 265 232 278 ^B		
	1.4 TDI						0 265 234 714 ^T		
						RDK	0 265 232 281 ^B		
							0 265 234 717 ^T		
		05.06-05.15	51/59/63			RDK	0 265 232 284 ^F		
						RDK	0 265 232 287 ^F		
	1.6	05.06-01.11	66/77			RDK	0 265 232 278 ^B		
	1.6 TDI						0 265 234 714 ^T		
						RDK	0 265 232 281 ^B		
							0 265 234 717 ^T		
		05.06-05.15	66/77			RDK	0 265 232 284 ^F		
						RDK	0 265 232 287 ^F		
	1.9 TDI	03.06-03.10	74/77			RDK	0 265 232 278 ^B		
							0 265 232 284 ^F		
							0 265 234 714 ^T		

		S							
1.9 TDI		03.06-03.10	74/77			RDK	0 265 232 281 ^B		
							0 265 232 287 ^F		
							0 265 234 717 ^T		
 1.2		05.06-03.10	47/51				0 265 005 692		
1.4 TDI		05.06-03.10	51/59/63				0 265 005 692		
1.6		05.06-07.10	77				0 265 005 692		
1.9 TDI		03.06-03.10	74/77				0 265 005 692		
Superb Combi [3T5]									
									
 1.4 TSI		09.09-05.15	92			MQO	0 986 486 554	19,05	
1.6 TDI		09.10-05.15	77			MQO	0 986 486 554	19,05	
1.8 TSI		03.09-05.15	112			MQO	0 986 486 554	19,05	
1.8 TSI 4x4		09.09-05.15	118				0 986 486 595	29	
						MQO	0 986 486 554	19,05	
2.0 TDI		09.09-03.10	103				0 986 486 595	29	
				PR-Code OEM		MQO	0 986 486 554	19,05	
		02.10-05.15	103			MQO	0 986 486 554	19,05	
2.0 TDI		09.09-05.10	125				0 986 486 595	29	
2.0 TDI 4x4		05.10-05.15	125			MQO	0 986 486 554	19,05	
2.0 TDI 4x4		11.10-05.15	103			MQO	0 986 486 554	19,05	
2.0 TSI		05.10-05.15	147			MQO	0 986 486 554	19,05	
3.6 V6 4x4		09.09-05.15	191			MQO	0 986 486 554	19,05	
Superb [3T4]									
									
 1.4 TSI		04.08-05.15	92			MQO	0 986 486 554	19,05	
1.6 TDI		09.10-05.15	77			MQO	0 986 486 554	19,05	
1.8 TSI		03.08-05.09	118	PR-Code OEM		MQO	0 986 486 554	19,05	
		09.08-05.15	118			MQO	0 986 486 554	19,05	
1.8 TSI, TSI 4x4		03.09-05.15	112			MQO	0 986 486 554	19,05	
1.8 TSI 4x4		11.08-05.15	118			MQO	0 986 486 554	19,05	
2.0 TDI		03.08-03.10	103				0 986 486 595	29	
		01.09-03.10	103	PR-Code OEM		MQO	0 986 486 554	19,05	
		02.10-05.15	103			MQO	0 986 486 554	19,05	
2.0 TDI		06.08-05.10	125				0 986 486 595	29	
2.0 TDI 4x4		05.10-05.15	125			MQO	0 986 486 554	19,05	
2.0 TDI 4x4		11.10-05.15	103			MQO	0 986 486 554	19,05	
2.0 TSI		05.10-05.15	147			MQO	0 986 486 554	19,05	
3.6 V6 4x4		11.08-05.15	191			MQO	0 986 486 554	19,05	
Superb [3U4]									
									
 1.8 T		12.01-05.02	110	Fg.-Nr. →3U..3..017 299		JBH	0 986 481 046	25,4	
1.9 TDI		12.01-05.02	74/96	Fg.-Nr. →3U..3..017 299		JBH	0 986 481 046	25,4	
2.0		12.01-05.02	85	Fg.-Nr. →3U..3..017 299		JBH	0 986 481 046	25,4	
2.5 TDI		12.01-05.02	114	Fg.-Nr. →3U..3..017 299		JBH	0 986 481 046	25,4	
2.8		12.01-05.02	140/142	Fg.-Nr. →3U..3..017 299		JBH	0 986 481 046	25,4	
 1.8 T		12.01-03.08	110				0 986 486 054	19,05	
1.9 TDI		12.01-03.08	77/85/96			LLE	0 986 486 061	19,05	
		02.02-03.02	74	Fg.-Nr. →3U..2..018 519		LLE	0 986 486 054	19,05	
		04.02-10.05	74	Fg.-Nr. 3U..2..018 520→		LLE	0 986 486 061	19,05	
2.0		12.01-03.08	85				0 986 486 054	19,05	
2.0 TDI		10.05-03.08	91/103			LLE	0 986 486 061	19,05	
2.5 TDI		12.01-03.08	114/120			LLE	0 986 486 061	19,05	
2.8		12.01-03.08	140/142				0 986 486 054	19,05	



◀ SKODA Superb [3U4]

	1.8 T	12.01-03.08	110			0 986 486 548	22,2
	1.9 TDI	12.01-03.08	74/77/85/96			0 986 486 548	22,2
	2.0, TDI	12.01-03.08	85/91/103			0 986 486 548	22,2
	2.5 TDI	12.01-03.08	114/120			0 986 486 548	22,2
	2.8	12.01-03.08	140/142			0 986 486 548	22,2
	1.8 T	12.01-03.08	110			0 265 225 141 ^T	
					CS2	0 265 220 407 ^E	
	1.9 TDI	12.01-03.08	74/77/85/96			0 265 225 141 ^T	
					CS2	0 265 220 407 ^E	
	2.0	12.01-03.08	85/91/103			0 265 225 141 ^T	
	2.0 TDI				CS2	0 265 220 407 ^E	
	2.5 TDI	12.01-03.08	114/120			0 265 225 141 ^T	
				CS2	0 265 220 407 ^E		
2.8	12.01-03.08	140/142			0 265 225 141 ^T		
				CS2	0 265 220 407 ^E		
	1.8 T	12.01-03.08	110			0 265 005 252	
	1.9 TDI	12.01-03.08	74/77/85/96			0 265 005 252	
	2.0, TDI	12.01-03.08	85/91/103			0 265 005 252	
	2.5 TDI	12.01-03.08	114/120			0 265 005 252	
	2.8	12.01-03.08	140/142			0 265 005 252	

Superb [3V3]



	1.6 TDI	05.15→	88		MQO	0 986 486 554	19,05
	1.8 TSI	05.15→	132		MQO	0 986 486 554	19,05
	2.0 TDI, TDI 4x4, TSI	05.15→	110/140/162		MQO	0 986 486 554	19,05

Yeti



	1.8 TSI	02.11→	112	PR-Code 1ZE, PR-Code 1ZF	JBH, LLE	0 986 480 870	22
	1.8 TSI	02.11→	112	PR-Code 0EJ	MQ2	0 986 486 576	19
				PR-Code OEM	MQO	0 986 486 554	19,05

Yeti [5L7]



	1.2 TSI	09.09→	77	PR-Code 1ZE, PR-Code 1ZF	JBH, LLE	0 986 480 870	22
	1.4 TSI	06.10→	90	PR-Code 1ZE, PR-Code 1ZF	JBH, LLE	0 986 480 870	22
	1.6, TDI	11.10→	77/81	PR-Code 1ZE, PR-Code 1ZF	JBH, LLE	0 986 480 870	22
	1.8 TSI 4x4	05.09→	112/118	PR-Code 1ZE, PR-Code 1ZF	JBH, LLE	0 986 480 870	22
	2.0 TDI, TDI 4x4	05.09→	81/103/125	PR-Code 1ZE, PR-Code 1ZF	JBH, LLE	0 986 480 870	22
	1.2 TSI	09.09→	77	PR-Code 0EJ	MQ2	0 986 486 576	19
				PR-Code OEM	MQO	0 986 486 554	19,05
	1.4 TSI	06.10→	90	PR-Code 0EJ	MQ2	0 986 486 576	19
				PR-Code OEM	MQO	0 986 486 554	19,05
	1.6	11.10→	77/81	PR-Code 0EJ	MQ2	0 986 486 576	19
	1.6 TDI			PR-Code OEM	MQO	0 986 486 554	19,05
	1.8 TSI 4x4	05.09→	112/118			0 986 486 595	29
2.0 TDI 4x4	05.09-05.10	103/125			0 986 486 595	29	



SMART (MCC)

Forfour [454]

	1.1	01.04-06.07	47/55	Fg.-Nr. →B 125943 Fg.-Nr. B 125944→		0 265 234 500 ^T 0 265 235 099 ^T
	1.3	01.04-06.07	70	Fg.-Nr. →B 125943 Fg.-Nr. B 125944→		0 265 234 500 ^T 0 265 235 099 ^T
	1.5, Brabus, cdi, Sportstyle	01.04-06.07	50/70/80/ 90/130	Fg.-Nr. →B 125943 Fg.-Nr. B 125944→		0 265 234 500 ^T 0 265 235 099 ^T
	1.1	01.04-06.07	47/55			0 265 005 600 ⁵
	1.3	01.04-06.07	70			0 265 005 600 ⁵
	1.5, Brabus, cdi, Sportstyle	01.04-06.07	50/70/80/ 90/130			0 265 005 600 ⁵

Fortwo Cabrio [450]

	0.7, Brabus	01.05-03.07	45/55	Fg.-Nr. J182806→		0 265 234 307 ^T
	0.8 cdi	01.05-03.07	30	Fg.-Nr. J182806→		0 265 234 307 ^T

Fortwo Cabrio [451]

	0.8 cdi	07.11-09.13	40	Fg.-Nr. K507690→		0 265 005 774
	1.0, Brabus	04.07→	62/75		TW	0 265 005 774
	1.0 mhd	07.11→	52	Fg.-Nr. K507690→		0 265 005 774

Fortwo Coupé [450]

	0.7	02.04-12.04	45			0 265 225 376 ^T
		01.05-03.07	37	Fg.-Nr. J182806→		0 265 234 307 ^T
			45	Fg.-Nr. J182806→		0 265 234 307 ^T
	0.7 Brabus	01.05-03.07	55	Fg.-Nr. J182806→		0 265 234 307 ^T
	0.8 cdi	01.05-03.07	30	Fg.-Nr. J182806→		0 265 234 307 ^T

Fortwo Coupé [451]

	0.8 cdi	07.11-09.13	40	Fg.-Nr. K507690→		0 265 005 774
	1.0, Brabus	04.07→	62/75		TW	0 265 005 774
	1.0 mhd	07.11→	45/52	Fg.-Nr. K507690→		0 265 005 774

Fortwo ED Cabrio [451]

		05.07-05.12	20-30			0 265 230 391 ^T
		07.11-05.12	20-30	Fg.-Nr. K507690→		0 265 005 774
		06.12→	35-55			0 265 005 774
	Brabus	06.12→	60			0 265 005 774

Fortwo ED Coupé [451]

		05.07-05.12	20-30			0 265 230 391 ^T



◀ SMART Fortwo ED Coupé [451]								
		07.11-05.12	20-30	Fg.-Nr. K507690→		0 265 005 774		
		06.12→	35-55/60			0 265 005 774		
Roadster Coupé [452]								
	0.7 0.7 Brabus	04.03-11.05	45/60/74			0 204 220 116	20,6	
	0.7 0.7 Brabus	04.03-12.04	45/60/74			0 265 225 376 ^T		
Roadster [452]								
	0.7 0.7 Brabus	04.03-11.05	45/60/74			0 204 220 116	20,6	
	0.7	08.03-12.04	45			0 265 225 376 ^T		
		01.05-11.05	45	Fg.-Nr. J182806→		0 265 234 307 ^T		
	0.7, Brabus	04.03-12.04	60/74			0 265 225 376 ^T		
Smart Cabrio [450]								
	0.6	03.00-01.04	40/45/52			0 265 215 550 ^E		
	0.8 cdi	03.01-01.04	30			0 265 215 550 ^E		
Smart Coupé [450]								
	0.6	07.98-11.99	33/40			0 265 215 552 ^B		
		07.98-12.02	33/40			0 265 215 550 ^E		
		01.01-12.03	45			0 265 215 550 ^E		
		06.02-12.02	52			0 265 215 550 ^E		
	0.8 cdi	11.99-12.02	30			0 265 215 550 ^E		
Smart Crossblade [450]								
	0.6	10.02-01.04	52			0 265 215 550 ^E		
SSANGYONG								
Istana								
	2.9 D Van	04.95-06.03	70			1 267 000 814 ^H		
Istana [L]								
	2.3 i 16V	11.96-12.03	110			1 267 000 814 ^H		





Korando [KJ]

	2.0i	07.96-01.98	94	0 265 217 013 ^F
		02.98-05.01	94	0 265 217 415 ^F
	2.3D	07.96-01.98	58-59/103-105	0 265 217 013 ^F
	2.3i 16V	02.98-05.01	58-59/103-105	0 265 217 415 ^F
	2.9D	07.96-01.98	70-74	0 265 217 013 ^F
		09.96-12.05	70-74	0 265 215 008 ^H
		02.98-05.01	70-74	0 265 217 415 ^F
	2.9 TD Intercooler 4WD	07.96-01.98	88-97	0 265 217 013 ^F
		02.98-05.01	88-97	0 265 217 415 ^F
	3.2i 4WD	07.96-01.98	154-162	0 265 217 013 ^F
		02.98-05.01	154-162	0 265 217 415 ^F
	2.0i	07.96-01.98	94	0 265 109 047 ^K
	2.3D, i 16V	07.96-01.98	58-59/103-105	0 265 109 047 ^K
	2.9D, TD Intercooler 4WD	07.96-01.98	70-74/88-97	0 265 109 047 ^K
	3.2i 4WD	07.96-01.98	154-162	0 265 109 047 ^K
	2.0i	02.01-12.05	94	0 265 005 125
	2.3D, i 16V	02.01-12.05	58-59/103-105	0 265 005 125
	2.9D, TD Intercooler 4WD	02.01-12.05	70-74/88-97	0 265 005 125
	3.2i 4WD	02.01-12.05	154-162	0 265 005 125

Musso [MJ]

	2.0i	05.96-01.98	100	0 265 217 013 ^E
		07.99-12.05	100	0 265 217 415 ^F
	2.3D	07.93-05.96	57-58	0 265 200 071 ^H
		07.93-01.98	57-58	0 265 217 013 ^E
		07.99-12.05	57-58	0 265 217 415 ^F
	2.3i	05.96-01.98	103-110	0 265 217 013 ^E
		07.99-12.05	103-110	0 265 217 415 ^F
	2.9D	07.93-05.96	70-74	0 265 200 071 ^H
		07.93-01.98	70-74	0 265 217 013 ^E
		07.99-12.05	70-74	0 265 217 415 ^F
	2.9 TD Intercooler	05.97-01.98	88	0 265 217 013 ^E
		07.99-12.05	88	0 265 217 415 ^F
	3.2i	01.96-01.98	162	0 265 217 013 ^E
		01.96-12.05	162	0 265 215 008 ^H
		07.99-12.05	162	0 265 217 415 ^F
	2.0i	05.96-10.98	100	0 265 109 047 ^K
		05.96-12.05	100	AA 0 265 100 078 ^H
	2.3D	07.93-10.98	57-58/	0 265 109 047 ^K
	2.3i		103-110	
		07.93-12.05	57-58/103-110	AA
	2.9D	07.93-01.96	88	0 265 109 047 ^K
		07.93-10.98	70-74	0 265 109 047 ^K
		07.93-12.05	70-74	AA
	2.9 TD Intercooler	05.97-10.98	88	0 265 109 047 ^K
		05.97-12.05	88	AA
	3.2i	01.96-10.98	162	0 265 109 047 ^K
		01.96-12.05	162	AA
	2.0i	10.01-12.05	100	0 265 005 125
	2.3D, i	10.01-12.05	57-58/103-110	0 265 005 125
	2.9D, TD Intercooler	10.01-12.05	70-74/88	0 265 005 125
	3.2i	10.01-12.05	162	0 265 005 125



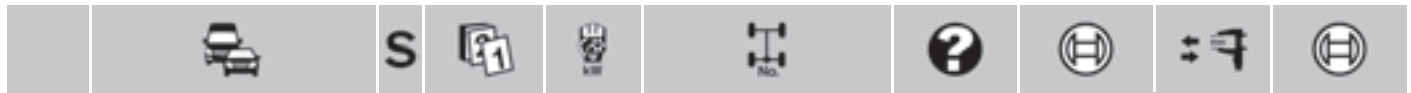

◀ SSANGYONG

Rexton



	2.3 RX230 4WD	05.02-12.06	110		0 265 005 125
	2.8 i	03.03-04.06	148		0 265 005 125
	2.9 TD	09.02-12.09	88		0 265 005 125
	3.2 i 4WD	09.02-12.09	162		0 265 005 125

STEYR (STEYR-DAIMLER-PUCH AG)

G



	300 DT	01.98->	130		0 265 213 009^H
	320	01.98->	158		0 265 213 009^H
	500 V8	01.98->	218		0 265 213 009^H

SUBARU

Forester [SF]



























	2.0 i S Turbo 4x4	03.98-05.02	125-130	RLE	F 026 A01 734
	2.0 i 4x4	ABS 01.97-05.02	90/92	RLE	F 026 A01 734
	2.0 i S Turbo 4x4	03.98-05.02	125-130	RLE	F 026 A01 934
	2.0 i 4x4	03.97-07.98	90	RLE	F 026 A01 920
		03.98-05.02	92	RLE	F 026 A01 933
	2.0 i S Turbo 4x4	03.98-05.02	125-130	RLE	F 026 A06 034
	2.0 i 4x4	01.97-05.02	90/92		F 026 A02 601

Forester [SG]































	2.0 i S Turbo 4x4, i 4x4	06.02-11.07	92/116/130	RLE	F 026 A01 734
	2.5 i Turbo 4x4	04.03-06.04	155	RLE	F 026 A06 902
		OFD 07.04-11.07	155	RLE,TW	F 026 A01 734
		06.05-11.07	169	RLE,TW	F 026 A01 734
					F 026 A06 902
					F 026 A06 902
	2.5 i 4x4	06.02-11.07	115-123/129	RLE	F 026 A06 902
	2.0 i S Turbo 4x4	06.02-05.05	130	RLE	F 026 A06 901
	2.0 i 4x4	06.02-11.07	92/116	RLE	F 026 A07 517
	2.5 i Turbo 4x4	04.03-11.07	155/169	RLE	F 026 A06 901
	2.5 i 4x4	06.02-11.07	115-123/129	RLE	F 026 A07 517
	2.0 i S Turbo 4x4	06.02-05.05	130		F 026 A06 941
	2.0 i 4x4	06.02-06.04	92		F 026 A02 601
		07.04-05.05	92		F 026 A07 638
		06.05-11.07	116		F 026 A07 638
	2.5 i Turbo 4x4	04.03-05.05	155		F 026 A06 941
	2.5 i 4x4	06.02-06.04	115-123		F 026 A02 601
		07.04-12.05	115-123		F 026 A07 638
		06.05-11.07	129		F 026 A07 638

									
Forester [S12]									
									
	2.0	12.07-12.12	110				F 026 A07 638		
	2.5, X	12.07-12.12	125/126				F 026 A07 638		
	2.0	12.07-12.12	110			AG	0 265 005 705		
	2.5, Turbo, X	12.07-12.12	125/126/169			AG	0 265 005 705		
Forester [S13]									
									
	2.0	11.12→	110				F 026 A07 638		
Impreza [G12]									
									
	1.5 R, R 4x4	06.07-09.11	79				F 026 A07 638		
	2.0 R Crossover 4x4, R 4x4	06.07-12.11	110				F 026 A07 638		
	1.5 R	06.07-03.08	79				0 265 232 080^B		
		04.08-09.11	79				0 265 232 383^B		
	2.0 R 4x4	06.07-08.08	110			TW	0 265 235 477^T		
	1.5 R, R 4x4	06.07-09.11	79			VSP	0 265 005 705		
	2.0 R Crossover 4x4, R 4x4	06.07-12.11	110			AG	0 265 005 705		
Impreza [G23]									
									
	1.6, 4x4	10.11→	84				F 026 A07 638		
	2.0 4x4	10.11→	110				F 026 A07 638		
Impreza Kombi [GD, GG]									
									
	1.5 i 4WD	05.06-06.07	77			RLE	F 026 A06 902		
	1.6 i	10.00-06.01	70			AG,RLE,TW	F 026 A06 902		
	1.6 i 4WD	ABS 10.00-06.07	70			RLE	F 026 A06 902		
	2.0 i 4WD, i 4WD Turbo	10.00-06.07	92/118/160/165			RLE	F 026 A01 734		
	2.5 i 4WD, i 4WD Turbo	07.04-06.07	112/169			RLE	F 026 A01 734		
	1.6 i	10.00-06.01	70			GS,LLE	F 01G 09B 294		
		ABO 10.00-06.01	70			AG,LLE	F 01G 09B 294		
	1.6 i 4WD	ABO 10.00-06.07	70			LLE	F 01G 09B 294		
	2.0 i 4WD	10.00-06.07	92/118			RLE	F 026 A07 517		
	2.0 i 4WD Turbo	10.00-05.05	160/165			RLE	F 026 A06 901		
	2.5 i 4WD	07.04-05.05	112			RLE	F 026 A07 517		
	2.5 i 4WD Turbo	06.05-06.07	169			RLE	F 026 A06 901		
	2.0 i 4WD	10.00-06.04	92				F 026 A02 601		
		07.04-06.07	92				F 026 A07 638		
		06.05-06.07	118				F 026 A07 638		
	2.0 i 4WD Turbo	10.00-05.05	160/165				F 026 A06 941		
	2.5 i 4WD	07.04-05.05	112				F 026 A07 638		



		S							
◀ SUBARU									
Impreza Outback [GD, GG]									
	2.0 i 4WD	10.00-06.07	92			RLE	F 026 A01 734		
	2.0 i 4WD	10.00-06.07	92			RLE	F 026 A07 517		
	2.0 i 4WD	10.00-06.04	92				F 026 A02 601		
		07.04-06.07	92				F 026 A07 638		
Impreza Sedan [GD, GG]									
	1.6 i	10.00-06.07	70			RLE,TW	F 026 A06 902		
	1.6 i 4WD	ABS	10.00-06.07	70		RLE	F 026 A06 902		
	2.0 i 4WD, i 4WD Turbo, i 4WD Turbo STI	10.00-06.07	92/118/160/165/195			RLE	F 026 A01 734		
	2.5 i 4WD, , i 4WD Turbo	07.01-06.07	112/169			RLE	F 026 A01 734		
	1.6 i	10.00-07.05	70			GS,LLE	F 01G 09B 294		
		ABO	10.00-07.05	70		AG,LLE	F 01G 09B 294		
	1.6 i 4WD	ABO	10.00-06.07	70		LLE	F 01G 09B 294		
	2.0 i 4WD	10.00-06.07	92/118			RLE	F 026 A07 517		
	2.0 i 4WD Turbo, i 4WD Turbo STI	10.00-05.05	160/165/195			RLE	F 026 A06 901		
	2.5 i 4WD	07.01-05.05	112			RLE	F 026 A07 517		
	2.5 i 4WD Turbo	06.05-06.07	169			RLE	F 026 A06 901		
	2.0 i 4WD	10.00-06.04	92				F 026 A02 601		
		07.04-06.07	92				F 026 A07 638		
		06.05-06.07	118				F 026 A07 638		
	2.0 i 4WD Turbo	10.00-05.05	160/165				F 026 A06 941		
	2.5 i 4WD	07.01-06.04	112				F 026 A02 601		
		07.04-05.05	112				F 026 A07 638		
Impreza Sedan [G12]									
	1.5 R	03.08-09.11	79				F 026 A07 638		
	1.5 R 4x4								
	1.5 R	09.10-09.11	79				0 265 232 383^B		
	1.5 R	09.10-09.11	79				0 265 005 705		
	1.5 R 4x4	03.08-09.11	79			VSP	0 265 005 705		
Impreza Sedan [G13]									
	1.6 4x4	10.11→	84				F 026 A07 638		
	2.0 4x4	10.11→	110				F 026 A07 638		
Impreza STI Sedan [GD, GG]									
	2.5 i 4WD Turbo	09.03-06.07	206			RLE	F 026 A01 734		



								
 2.5 i 4WD Turbo			09.03-06.07	206		RLE	F 026 A06 901	
Impreza WRX STI [G22]								
								
 2.5			09.10-01.14	221		AG	0 265 005 705	
Impreza WRX STI Hatchback [G22]								
								
 2.5			06.07-01.14	221-243		AG	0 265 005 705	
Impreza WRX Wagon [G22]								
								
 2.5 STI AWD			06.07-01.14			AG	0 265 005 705	
Legacy [BL/BP]								
								
 2.5 4WD			07.03-06.06	121		RLE	F 026 A01 933	
 3.0 4WD			07.03-11.05	180		RLE	F 026 A06 909	
 2.0 R 4WD			03.05-06.07	110-121			F 026 A07 638	
			07.07-05.09	110-121		TW	F 026 A07 638	
 2.0 4WD			07.03-06.05	101			F 026 A07 638	
 2.5 4WD			07.03-06.06	121			F 026 A07 638	
			07.06-06.07	127			F 026 A07 638	
			07.07-05.09	127		TW	F 026 A07 638	
 2.0 D 4WD			04.07-05.09	110-121			0 265 234 663^T	
 2.0 R 4WD			07.06-06.07	110-121		AG	0 265 231 880^B	
						GS	0 265 231 882^B	
			07.07-05.09	110-121		AG	0 265 232 058^B	
 2.5 4WD			07.06-06.07	127		AG	0 265 231 880^B	
						GS	0 265 231 882^B	
			07.06-05.09	127		AG	0 265 234 661^T	
			07.07-05.09	127		AG	0 265 232 058^B	
 3.0 4WD			07.06-06.07	180		AG	0 265 231 880^B	
						GS	0 265 231 882^B	
			07.07-05.09	180		AG	0 265 232 058^B	
Legacy Kombi [BE/BH]								
								
 2.0 i 4WD			10.98-06.03	92		RLE	F 026 A01 734	
 2.0 i 4WD			10.98-06.03	92		RLE	F 026 A01 933	
 2.0 i 4WD			10.98-06.03	92			F 026 A02 601	





◀ SUBARU

Legacy Kombi [BL/BP]



	2.5 4WD	07.03-06.06	121		RLE	F 026 A01 933	
	3.0 4WD	07.03-11.05	180		RLE	F 026 A06 909	
	2.0 R 4WD	03.05-06.07	110-121			F 026 A07 638	
		07.07-05.09	110-121		TW	F 026 A07 638	
	2.0 4WD	07.03-06.05	101			F 026 A07 638	
	2.5 4WD	07.03-06.06	121				F 026 A07 638
		07.06-06.07	127				F 026 A07 638
		07.07-05.09	127		TW		F 026 A07 638
	2.0 D 4WD	04.07-05.09	110-121			0 265 234 663 ^T	
	2.0 R 4WD	07.06-06.07	110-121		AG	0 265 231 880 ^B	
					GS	0 265 231 882 ^B	
		07.07-05.09	110-121		AG	0 265 232 058 ^B	
	2.5 4WD	07.06-06.07	127		AG	0 265 231 880 ^B	
					GS	0 265 231 882 ^B	
				07.06-05.09	127	AG	0 265 234 661 ^T
		07.07-05.09	127		AG	0 265 232 058 ^B	
	3.0 4WD	07.06-06.07	180		AG	0 265 231 880 ^B	
					GS	0 265 231 882 ^B	
	07.07-05.09	180		AG	0 265 232 058 ^B		

Legacy Outback [BE/BH]



	3.0 i 4WD	05.02-06.03	154		RLE,SA, TW	F 026 A06 902
--	-----------	-------------	-----	--	---------------	----------------------

Legacy Outback [BL/BP]



	2.5 4WD	07.03-10.05	121		RLE	F 026 A01 933
	2.5 4WD	07.03-03.07	121			F 026 A07 638
07.06-06.07		127			F 026 A07 638	
04.07-06.09		121		TW	F 026 A07 638	
07.07-05.09		127		TW	F 026 A07 638	
	2.0 D 4WD	04.07-05.09	110-121			0 265 234 663 ^T
	2.5 4WD	07.06-06.07	127		AG	0 265 231 884 ^B
					GS	0 265 231 886 ^B
				07.07-05.09	127	AG
				GS	0 265 232 064 ^B	
	3.0 4WD	07.06-06.07	180			0 265 231 884 ^B
07.07-05.09				180		0 265 232 062 ^B

XV [G33]



	1.6 i	09.11→	84			F 026 A07 638
	2.0 i	09.11→	110			F 026 A07 638

SUZUKI									
Alto Hatchback [AMF]									
	1.0	OFD	12.08→	50		GS,RLE		0 204 B55 420	
Baleno Hatchback									
	1.3i 16V	ABO	04.95-04.05	62-63				F 026 A05 905	
	1.6i 16V, i 16V 4WD	ABO	04.95-04.05	72-74				F 026 A05 905	
	1.8i 16V		09.95-09.05	89		RLE		F 01G 09C 1BN	F 01G 09B 214 ⁶
		ABO	09.95-09.05	89				F 026 A05 905	
	1.9D Turbo	ABO	04.98-05.02	55		LLE		F 026 A05 905	
	1.6i 16V 4WD		04.95-04.05	72-74				F 026 A01 864	
	1.8i 16V		09.95-09.05	89				F 026 A01 864	
	1.9D Turbo		04.98-05.02	55				F 026 A01 864	
	1.6i 16V 4WD		04.95-04.05	72-74				F 026 A07 701	
	1.8i 16V		09.95-09.05	89				F 026 A07 701	
	1.9D Turbo		04.98-05.02	55				F 026 A07 701	
Baleno Sedan									
	1.3i 16V	ABO	04.95-04.05	62-63				F 026 A05 905	
	1.5i 16V	ABS	04.95-04.05	71		TW		F 01G 09C 1FR	
	1.6i 16V, i 16V 4WD	ABO	04.95-04.05	72-74				F 026 A05 905	
	1.8i 16V		09.95-09.05	89		RLE		F 01G 09C 1BN	F 01G 09B 214 ⁶
		ABO	09.95-09.05	89				F 026 A05 905	
	1.9D Turbo	ABO	12.98-05.02	55		LLE		F 026 A05 905	
	1.6i 16V 4WD		04.95-04.05	72-74				F 026 A01 864	
	1.8i 16V		09.95-09.05	89				F 026 A01 864	
	1.9D Turbo		12.98-05.02	55				F 026 A01 864	
	1.6i 16V 4WD		04.95-04.05	72-74				F 026 A07 701	
	1.8i 16V		09.95-09.05	89				F 026 A07 701	
	1.9D Turbo		12.98-05.02	55				F 026 A07 701	
Baleno Wagon									
	1.3i 16V	ABO	09.97-09.07	62-63				F 026 A05 905	
	1.6i 16V, i 16V 4WD	ABO	08.96-05.02	72-74				F 026 A05 905	
	1.8i 16V		08.96-08.06	89		RLE		F 01G 09C 1BN	F 01G 09B 214 ⁶
		ABO	08.96-08.06	89				F 026 A05 905	
	1.9D Turbo	ABO	12.98-05.02	55		LLE		F 026 A05 905	
	1.6i 16V 4WD		08.96-05.02	72-74				F 026 A01 864	
	1.8i 16V		08.96-08.06	89				F 026 A01 864	
	1.9D Turbo		12.98-05.02	55				F 026 A01 864	
	1.6i 16V 4WD		08.96-05.02	72-74				F 026 A07 701	
	1.8i 16V		08.96-08.06	89				F 026 A07 701	
	1.9D Turbo		12.98-05.02	55				F 026 A07 701	

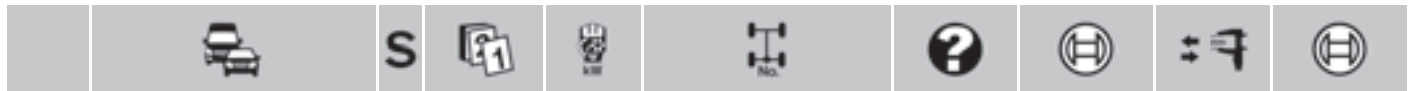

◀ SUZUKI

Cappuccino



	660 Turbo	08.93-08.03	47		F 01G 09C 1BP
	660 Turbo	08.93-08.03	47		F 01G 09B 0XB

Carry [ED]



	1.0	10.93-10.96	33		F 01G 09B 22J
--	-----	-------------	----	--	----------------------

Carry Van [ED]



	1.0	10.93-10.96	33		F 01G 09B 22J
--	-----	-------------	----	--	----------------------

Escudo

























	1.6 i	01.94→	79		F 026 A06 512
	1.6 i	01.94→	79		F 026 A02 612





















Grand Vitara



	1.6 4WD	MFD 10.05→	78	AG	0 204 023 106
				GS	0 204 023 105
	1.9 DDiS	OFD 10.05→	78	GS	0 204 023 107
		MFD 10.05→	95	AG	0 204 023 106
				GS	0 204 023 105
	2.0 D Turbo, i 4WD	OFD 10.05→	95	GS	0 204 023 107
		ABS 03.98→	68/103-108	RLE	F 026 A06 500
		MFD 10.05→	99-103	AG	0 204 023 106
	2.0 4WD			GS	0 204 023 105
		OFD 10.05→	99-103	GS	0 204 023 107
		MFD 09.08→	122-124	AG	0 204 023 106
	2.4 4x4			GS	0 204 023 105
		OFD 09.08→	122-124	GS	0 204 023 107
		ABS 04.98-12.05	87/106-116	RLE	F 026 A06 500
	3.2 4x4	MFD 01.09→	171	AG	0 204 023 106
				GS	0 204 023 105
		OFD 01.09→	171	GS	0 204 023 107
	1.6 4WD	10.05→	78	LLE	0 204 023 190
				RLE	0 204 023 188
	1.9 DDiS	10.05→	95	LLE	0 204 023 190
				RLE	0 204 023 188
	2.0 4WD	10.05→	99-103	LLE	0 204 023 190
				RLE	0 204 023 188
	2.4 4x4	09.08→	122-124	LLE	0 204 023 190
				RLE	0 204 023 188
	3.2 4x4	01.09→	171	LLE	0 204 023 190
				RLE	0 204 023 188

									
	1.6 i16V	03.98-12.05	69-71				F 026 A06 512		
	2.0 D Turbo, i 4WD, i 16V, TDi XL-7	03.98→	68/80/94/103-108				F 026 A06 512		
	2.5 i4WD, i 4x4	04.98-12.05	87/106-116				F 026 A06 512		
	2.7 iXL-7 4WD, XL-7	06.01→	127-135				F 026 A06 512		
	1.6 i16V	03.98-12.05	69-71				F 026 A02 612		
	2.0 D Turbo	03.98-03.08	68				F 026 A06 577		
		11.00-12.05	80				F 026 A06 577		
	2.0 i4WD, i 16V	03.98→	94/103-108				F 026 A02 612		
	2.0 TDi XL-7	06.01-10.05	80	Fg.-Nr. JSAHT83V00201066→, LLE JS3TX83V64300001→			F 026 A06 577		
	2.5 i4WD, i 4x4	04.98-12.05	87/106-116				F 026 A02 612		
	2.7 XL-7	06.01-08.08	127-135	Fg.-Nr. →00200000			F 026 A02 612		
Grand Vitara Cabrio									
									
	1.6 i16V	03.98-03.08	69				F 026 A02 612		
	2.0 i16V	03.98-03.08	94				F 026 A02 612		
Ignis Hatchback									
									
	1.3 i16V	ABO	10.00-09.03	61			F 01G 062 00S		F 01G 09B 216⁷
	1.3 i16V 4WD	ABS	10.00-09.03	61			F 01G 09C 1DK		F 01G 09B 216⁷
	1.5 i16V Sport		12.03-12.07	80			F 01G 09C 1D1		
	1.3 DDiS Turbo		10.03-12.07	51			0 204 125 815		
	1.3 i16V		10.00-09.03	61	Fg.-Nr. S00170001→		F 01G 061 0D9		
		ABO	10.00-09.03	61	Fg.-Nr. →S00170000		F 01G 061 0D9		
		ABS	10.00-09.03	61	Fg.-Nr. →S00170000		F 01G 09B 1TE		
	1.3 i16V, i16V 4WD		10.03-12.07	69			0 204 125 815		
	1.3 i16V 4WD		10.00-09.03	61			F 01G 061 0D9		
	1.5 i16V Sport		12.03-12.07	80			F 01G 061 00L		
	1.5 i16V, i16V 4WD		10.03-12.07	73			0 204 125 815		
Jimny [FJ]									
									
	1.5 DDiS 4WD		12.03→	48			F 026 A06 577		
Liana Hatchback									
									
	1.3 i16V		03.01-12.04	66			F 026 A07 701		
	1.6 i16V, i16V 4WD		03.01-04.08	76			F 026 A07 701		
	1.8 i16V		04.05-12.07	92			F 026 A07 701		
Liana Sedan									
									
	1.6 i16V		04.02-12.07	76	Fg.-Nr. →00300000		F 026 A05 942		
	1.6 i16V 4WD								
	1.3 i16V		04.02-12.04	66			F 026 A07 701		
	1.6 i16V, i16V 4WD		04.02-12.07	76			F 026 A07 701		
	1.8 i16V		04.05-12.07	92			F 026 A07 701		

















			S									
◀ SUZUKI												
Samurai												
	1.3	03.87-03.95	50	Fg.-Nr. →*00115000		0986	480 789	20,6				
				Fg.-Nr. *00115001→	JBH	0986	480 781	22,2				
				09.88-03.95	44	JBH	0986	480 781	22,2			
					51	JBH	0986	480 781	22,2			
				04.95-12.97	51		0986	480 782	22,2			
1.3 i	11.88-12.04	47		0986	480 782	22,2						
Samurai Cabrio												
	1.3	03.87-03.95	47	Fg.-Nr. →*00120000		0986	480 789	20,6				
				Fg.-Nr. *00120001→	JBH	0986	480 781	22,2				
				09.88-03.95	51	JBH	0986	480 781	22,2			
					04.95-12.97	51		0986	480 782	22,2		
				1.3 i	04.95-12.04	47		0986	480 782	22,2		
Splash [A5B]												
	1.0	MFD	01.08→	48-50	LLE	0 204	720 435	22,2				
					RLE	0 204	720 437	22,2				
		OFD	01.08→	48-50	LLE	0 204	054 366	22,2				
					RLE	0 204	054 379	22,2				
	1.2	MFD	01.08→	63/66-69	LLE	0 204	720 435	22,2				
					RLE	0 204	720 437	22,2				
		OFD	01.08→	63/66-69	LLE	0 204	054 366	22,2				
					RLE	0 204	054 379	22,2				
	1.3 DDiS	MFD	01.08→	55	LLE	0 204	720 435	22,2				
					RLE	0 204	720 437	22,2				
OFD		01.08→	55	LLE	0 204	054 366	22,2					
				RLE	0 204	054 379	22,2					
	1.0	01.08→	48-50	Fg.-Nr. →00500000		0 204	051 673					
				Fg.-Nr. 00500001→	AG,RLE	0 204	719 401					
		MFD	01.08→	48-50	Fg.-Nr. 00500001→	AG,LLE	0 204	719 397				
					GS,SSJ	0 204	719 397					
		08.12→	50	LLE	0 204	719 399						
		OFD	01.08→	48-50	Fg.-Nr. 00500001→	AG,LLE	0 204	719 396				
					GS,SSJ	0 204	719 398					
		08.12→	50	LLE	0 204	051 673						
	1.2	01.08→	63/66-69	Fg.-Nr. →00500000		0 204	051 673					
				Fg.-Nr. 00500001→	AG,RLE	0 204	719 401					
		MFD	01.08→	63/66-69	Fg.-Nr. 00500001→	AG,LLE	0 204	719 397				
					GS,SSJ	0 204	719 397					
		08.12→	50	LLE	0 204	719 399						
		OFD	01.08→	63/66-69	Fg.-Nr. 00500001→	AG,LLE	0 204	719 396				
					GS,SSJ	0 204	719 398					
		08.12→	50	LLE	0 204	051 673						
1.3 DDiS	01.08→	55		0 204	051 673							
Swift Cabrio [EA]												
	1.3	09.91-12.95	49/50		LLE	0986	480 780	20,6				
	1.3 i											

		S							
Swift Hatchback [EA]									
									
	1.0, i	10.89-09.95	39/40				0 986 480 780	20,6	
	1.3 i	03.89-09.95	50/74				0 986 480 780	20,6	
	1.3 16V GTi					RLE	0 986 480 660	20,6	
Swift Hatchback [FZ/NZ]									
									
	1.2	09.10→	66-69			LLE	0 204 720 432		
						RLE	0 204 720 433		
	1.3 DDiS	09.10→	55			LLE	0 204 720 432		
	1.3 DDiS D Turbo					RLE	0 204 720 433		
	1.6 Sport	10.11→	100			LLE	0 204 720 432		
						RLE	0 204 720 433		
	1.2	09.10→	66-69			LLE	0 204 719 392		
						RLE	0 204 719 390		
		01.11→	66-69			GS	0 204 748 113		
	1.2 4WD	01.11→	69			GS	0 204 748 113		
	1.3 DDiS	09.10→	55			LLE	0 204 719 393		
	1.3 DDiS D Turbo					RLE	0 204 719 391		
	1.4	01.11→	70			GS	0 204 748 113		
	1.6 Sport	10.11→	100			LLE	0 204 719 392		
						RLE	0 204 719 390		
Swift Hatchback [MA]									
									
	1.0 i	ABO 03.96-12.04	39			RLE	0 986 480 660	20,6	
	1.3 i, i 16V	ABO 06.96-12.04	50/63			RLE	0 986 480 660	20,6	
	1.0 i	03.96-12.04	39	Fg.-Nr. *339537*→			0 265 216 599^B		
	1.3 i, i 16V	06.96-12.04	50/63	Fg.-Nr. *339537*→			0 265 216 599^B		
	1.0 i	03.96-12.04	39	Fg.-Nr. →*00339536			1 273 004 323^H		
		04.97-12.04	39				1 273 004 323^H		
	1.3 i, i 16V	04.97-12.04	50/63				1 273 004 323^H		
Swift Hatchback [MZ/EZ]									
									
	1.3, DDiS, DDiS D Turbo, 4WD	MFD 11.04→	51-55/67			LLE	0 204 720 435	22,2	
						RLE	0 204 720 437	22,2	
		OFD 11.04→	51-55/67			LLE	0 204 054 366	22,2	
						RLE	0 204 054 379	22,2	
	1.5	MFD 11.04→	75-81			LLE	0 204 720 435	22,2	
						RLE	0 204 720 437	22,2	
		OFD 11.04→	75-81			LLE	0 204 054 366	22,2	
						RLE	0 204 054 379	22,2	
	1.6	MFD 01.07→	92			LLE	0 204 720 435	22,2	
						RLE	0 204 720 437	22,2	
		OFD 01.07→	92			LLE	0 204 054 366	22,2	
						RLE	0 204 054 379	22,2	
	1.3	11.04→	67				0 204 051 175		
	1.3 DDiS, DDiS D Turbo	08.05→	51-55				0 204 051 673		
	1.3 4WD	11.04→	67				0 204 051 673		
	1.5	11.04→	75-81			TW	0 204 051 175		
							0 204 051 673		
	1.6	01.07→	92				0 204 719 399		



◀ SUZUKI Swift Hatchback [MZ/EZ]									
	1.3 DDiSD Turbo		08.05→	51-55	Fg.-Nr. →00500000			0986 486 588	31
Swift [MA]									
	1.0 i	ABO	03.96-12.04	39		RLE		0986 480 660	20,6
	1.3 i, i 16V	ABO	06.96-12.04	50/63		RLE		0986 480 660	20,6
	1.0 i		03.96-12.04	39	Fg.-Nr. *339537*→			0 265 216 599^B	
	1.3 i, i 16V		06.96-12.04	50/63	Fg.-Nr. *339537*→			0 265 216 599^B	
	1.0 i		04.97-12.04	39				1 273 004 323^H	
	1.3 i, i 16V		04.97-12.04	50/63				1 273 004 323^H	
Swift Sedan [EA]									
	1.6 i 16V, i 16V 4WD, 16V, 16V 4WD		09.91-09.95	68/70		LLE		0986 480 780	20,6
						RLE		0986 480 660	20,6
	1.6 i 16V, i 16V 4WD, 16V, 16V 4WD		09.91-09.95	68/70				F 026 A01 864	
	1.6 i 16V, i 16V 4WD, 16V, 16V 4WD		09.91-09.95	68/70				F 026 A07 701	
SX4									
	1.6 VVT	MFD	12.07→	75-79/88		AG		0 204 023 296	
		GS						0 204 023 294	
		OFD	12.07→	75-79/88		AG		0 204 023 292	
		GS						0 204 023 290	
	1.6 VVT		12.07→	75-79/88				0 204 023 774	
	1.6 VVT		12.07→	75-79	Fg.-Nr. →00300000			0 265 232 090^B	
					Fg.-Nr. 00300001→			0 265 232 534^B	
			09.09→	88	Fg.-Nr. →00310000			0 265 232 090^B	
					Fg.-Nr. 00310001→			0 265 232 534^B	
SX4 Hatchback									
	1.5	MFD	05.06→	73				0 204 054 380	22,2
		OFD	05.06→	73				0 204 054 374	22,2
	1.6 DDiS	MFD	04.07→	66		LLE		0 204 054 420	22,2
						RLE		0 204 054 568	22,2
		OFD	04.07→	66		LLE		0 204 054 419	22,2
						RLE		0 204 054 421	22,2
	1.6 VVT	MFD	12.07→	75-79		AG		0 204 023 296	
						GS		0 204 023 294	
			09.09→	88		AG		0 204 023 296	
						GS		0 204 023 294	
		OFD	12.07→	75-79		AG		0 204 023 292	
						GS		0 204 023 290	
			09.09→	88		AG		0 204 023 292	
						GS		0 204 023 290	



		S							
1.6 VVT		MFD	05.06→	79-81			0 204 054 380	22,2	
1.6 VVT 4WD			09.09→	88			0 204 054 380	22,2	
		OFD	05.06→	79-81			0 204 054 374	22,2	
			09.09→	88			0 204 054 374	22,2	
1.9 DDiS		MFD	05.06→	88			0 204 054 380	22,2	
1.9 DDiS 4WD		OFD	05.06→	88			0 204 054 374	22,2	
2.0 DDiS			09.09→	99		RLE	0 204 054 374	22,2	
2.0 DDiS 4WD		MFD	09.09→	99		LLE	0 204 054 420	22,2	
		OFD	09.09→	99		LLE	0 204 054 419	22,2	
 1.5			05.06→	73			0 204 051 534		
1.6 DDiS			04.07→	66			0 204 051 534		
1.6 VVT			12.07→	75-79			0 204 023 774		
			09.09→	88			0 204 023 774		
							0 204 051 534		
1.6 VVT, VVT 4WD			05.06→	79-81			0 204 051 534		
1.6 VVT 4WD			09.09→	88			0 204 051 534		
1.9 DDiS, DDiS 4WD			05.06→	88			0 204 051 534		
2.0 DDiS, DDiS 4WD			09.09→	99			0 204 051 534		
 1.5			05.06→	73			0 265 231 669 ^B		
1.6 DDiS			04.07→	66	Fg.-Nr. →00450000		0 265 231 669 ^B		
					Fg.-Nr. 00450001→		0 265 237 049 ^B		
1.6 VVT			05.06→	79-81			0 265 231 669 ^B		
			12.07→	75-79	Fg.-Nr. →00300000		0 265 232 090 ^B		
					Fg.-Nr. 00300001→		0 265 232 534 ^B		
			09.09→	88			0 265 237 049 ^B		
							0 265 238 072 ^T		
					Fg.-Nr. →00310000		0 265 232 090 ^B		
					Fg.-Nr. 00310001→		0 265 232 534 ^B		
1.6 VVT 4WD			05.06→	79			0 265 231 671 ^B		
			09.09→	88	Fg.-Nr. 00450001→		0 265 237 051 ^B		
1.9 DDiS			05.06→	88			0 265 231 669 ^B		
1.9 DDiS 4WD			05.06→	88			0 265 231 671 ^B		
							0 265 235 368 ^T		
2.0 DDiS 4WD			09.09→	99			0 265 237 051 ^B		
SX4 S-Cross									
									
 1.6, DDiS, DDiS 4WD, 4WD			10.13→	88		LLE	0 204 797 151		
						RLE	0 204 797 153		
 1.6			10.13→	88		LLE,SSJ	0 204 797 148		
1.6 DDiS						LLE,SSJ	0 204 797 147		
1.6 DDiS 4WD						RLE,SSJ	0 204 797 150		
1.6 4WD						RLE,SSJ	0 204 797 149		
Vitara Cabrio [ET]									
									
 1.6			09.88-03.98	55/60			0 986 480 778	20,6	
1.6 i						RLE	F 026 A01 601		
1.6 i 16V			02.91-03.98	70-74			F 026 A05 906		
1.9 D 4x4			01.95-03.98	50			F 026 A05 906		
Vitara Cabrio [OS]									
									
 1.6 i			01.93-03.98	59			F 026 A05 906		



◀ SUZUKI

Vitara [ET]



	1.6	09.88-03.98	55/60		0986 480 778	20,6
	1.6 i			RLE	F 026 A01 601	
	1.6 i 16V	02.91-03.98	70		F 026 A05 906	
	1.9 D 4x4	01.95-03.98	50		F 026 A05 906	
	2.0 D Turbo, D Turbo Interc., i 24V	03.95-03.98	52/64/100		F 026 A01 864	
	2.5 i 24V	03.95-03.98	118		F 026 A01 864	
	2.0 D Turbo, D Turbo Interc., i 24V	03.95-03.98	52/64/100		F 026 A06 577	
	2.5 i 24V	03.95-03.98	118		F 026 A06 577	

Wagon R+ [EM]



	1.0 i 16V	ABO 09.97-05.00	48-52	RLE		F 01G 09B 20M ⁶
		ABS 09.97-05.00	48-52	LLE		F 01G 09C 1FX ⁶
				RLE		F 01G 09B 20M ⁶
	1.2 i 16V	ABO 07.98-05.00	51	RLE		F 01G 09B 20M ⁶
		ABS 07.98-05.00	51	RLE		F 01G 09B 20M ⁶
				LLE	F 01G 09C 115	
	1.2 i 16V 4WD	ABO 07.98-05.00	51	LLE		F 01G 09C 1FX ⁶
		ABS 07.98-05.00	51	RLE		F 01G 09B 20M ⁶
		ABS 07.98-05.00	51	RLE		F 01G 09B 20M ⁶
	1.0 i 16V	ABO 09.97-05.00	48-52	LLE	F 01G 09B 22W	
				RLE	F 01G 09B 0XC	
				LLE	F 01G 09B 22W	
	1.2 i 16V	ABO 07.98-05.00	51	LLE	F 01G 09B 22W	
				RLE	F 01G 09B 0XC	
	1.0 i 16V	ABO 09.97-05.00	48-52		F 01G 09L 04J	
					F 01G 09L 04J	

Wagon R+ [MM]



	1.0 i 16V	ABS 05.00-08.03	39	JBH	0986 480 872	20,6	
		1.2 i	ABS 05.04-08.08	59	JBH	0986 480 872	20,6
		1.3 DDiS D Turbo, i 16V, i 16V 4WD	ABS 05.00-03.06	51/56/69	JBH	0986 480 872	20,6
	1.0 i 16V		05.00-08.03	39	0204 125 742		
		1.2 i		05.04-08.08	59	0204 125 742	
		1.3 DDiS D Turbo, i 16V, i 16V 4WD		05.00-03.06	51/56/69	0204 125 742	

X-90



	1.6 i	09.95→	71		F 01G 09L 02C	
	1.6 i 4x4					

TESLA MOTORS

Model S



	40kWh	08.11→	185	LLE	0204 776 858	
	60 kWh	08.11→	223	LLE	0204 776 858	
	85 kWh, Performance	08.11→	270/310	LLE	0204 776 858	



TOYOTA

Auris [E15]

	2.0 D-4D	MFD 09.06→	93	LLE	0 204 123 755	22,2
				RLE	0 204 123 753	22,2
		OFD 09.06→	93	LLE	0 204 123 756	22,2
				RLE	0 204 123 754	22,2
	2.0 D-4D	09.06→	93		0 204 125 878	
				RLE	0 204 125 880	
	2.0 D-4D	09.06→	93		0 265 005 854	
	2.0 D-4D	09.06→	93		F 01G 065 00X	

Auris [E15, JTN]

	1.4 D-4D	MFD 10.06-03.08	66	LLE	0 204 123 755	22,2
				RLE	0 204 123 753	22,2
		04.08-08.12	66	LLE	0 204 123 804	22,2
				RLE	0 204 123 802	22,2
		OFD 10.06-03.08	66	LLE	0 204 123 756	22,2
				RLE	0 204 123 754	22,2
	04.08-08.12	66	LLE	0 204 123 805		
			RLE	0 204 123 803	22,2	
	2.0 D-4D	MFD 10.06-03.08	93	LLE	0 204 123 755	22,2
				RLE	0 204 123 753	22,2
		04.08-10.09	93	LLE	0 204 123 804	22,2
				RLE	0 204 123 802	22,2
OFD 10.06-03.08		93	LLE	0 204 123 756	22,2	
			RLE	0 204 123 754	22,2	
04.08-10.09	93	LLE	0 204 123 805			
		RLE	0 204 123 803	22,2		
	1.4 D-4D	MFD 10.06-08.12	66	LLE	0 204 125 885	
				RLE	0 204 745 792	
	OFD 10.06-08.12	66	LLE	0 204 125 886		
			RLE	0 204 125 884		
	2.0 D-4D	MFD 10.06-10.09	93	LLE	0 204 125 885	
				RLE	0 204 745 792	
OFD 10.06-10.09	93	LLE	0 204 125 886			
		RLE	0 204 125 884			
	1.3 VVT-i	09.08-10.09	74	RLE	F 026 A06 508	
	1.4, D-4D	10.06-08.12	66/71	RLE	F 026 A06 508	
	1.6	10.06-08.12	91/97	RLE	F 026 A06 508	
	1.8 i	12.08-10.09	108	RLE	F 026 A06 508	
	1.4	10.06-12.08	71		F 026 A02 593	
	1.6	10.06-01.09	91		F 026 A06 570	
	1.4 D-4D	10.06-08.12	66		0 265 005 854	
	2.0 D-4D	10.06-10.09	93		0 265 005 854	





◀ TOYOTA Auris [E15, JTN]













	1.3 VVT-i	09.08-10.09	74		TW	F 01G 065 00X		
	1.4	10.06-12.08	71		TW	F 01G 065 00X		
	1.4 D-4D	10.06-08.12	66			F 01G 065 00X		
	1.6	12.08-10.09	97		TW	F 01G 065 00X		
	1.8 i	12.08-10.09	108		TW	F 01G 065 00X		
	2.0 D-4D	10.06-10.09	93		TW	F 01G 065 00X		

Auris [E15, NMT, SB1]















	1.3 VVT-i		11.08-10.12	74		LLE,SSJ	0 204 123 800	22,2						
						LLE,SSJ	0 204 123 801	22,2						
						RLE,SSJ	0 204 123 798	22,2						
						RLE,SSJ	0 204 123 799	22,2						
	1.4	MFD	02.07-03.08	66/71			RLE	0 204 123 749	22,2					
							1.4 D-4D	02.07-10.12	66/71			LLE	0 204 123 800	22,2
												RLE	0 204 123 798	22,2
												OFD	02.07-10.12	66/71
							RLE	0 204 123 799	22,2					
	1.6	MFD	02.07-03.08	91			RLE	0 204 123 749	22,2					
							LLE	0 204 123 800	22,2					
							RLE	0 204 123 798	22,2					
							LLE	0 204 123 800	22,2					
		OFD	02.07-10.12	91/97				RLE	0 204 123 798	22,2				
								LLE	0 204 123 801	22,2				
								RLE	0 204 123 799	22,2				
								LLE	0 204 123 800	22,2				
	1.8	MFD	02.09-10.12	108			LLE	0 204 123 800	22,2					
							RLE	0 204 123 798	22,2					
		OFD	02.09-10.12	108				LLE	0 204 123 801	22,2				
								RLE	0 204 123 799	22,2				
	2.0 D-4D	MFD	02.07-03.08	93			RLE	0 204 123 749	22,2					
							LLE	0 204 123 800	22,2					
							RLE	0 204 123 798	22,2					
OFD							02.07-10.12	93	LLE	0 204 123 801	22,2			
							RLE	0 204 123 799	22,2					
2.2 D-CAT			02.07-03.08	130			RLE	0 204 123 749	22,2					
							LLE	0 204 123 800	22,2					
							RLE	0 204 123 798	22,2					
	RLE						0 204 123 798	22,2						

	1.3 VVT-i	MFD	11.08-10.12	74			LLE,SSJ	0 204 715 886							
							LLE,SSJ	0 204 125 879							
							RLE,SSJ	0 204 125 875							
							OFD	11.08-12.09	74				LLE,SSJ	0 204 715 887	
													RLE,SSJ	0 204 125 877	
													LLE,SSJ	0 204 709 895	
													LLE,SSJ	0 204 709 897	
													RLE,SSJ	0 204 709 903	
													RLE,SSJ	0 204 709 893	
							1.4	MFD	02.07-03.09	71			LLE,TW	0 204 125 879	
													RLE,TW	0 204 125 880	
													RLE,TW	0 204 125 875	
	OFD	02.07-03.09	71					RLE,TW	0 204 807 695						
								LLE,TW	0 204 125 882						
								RLE,TW	0 204 709 895						
	1.4 D-4D	MFD	02.07-10.12	66			LLE	0 204 125 880							
							RLE	0 204 807 695							
							OFD	02.07-12.09	66	LLE	0 204 125 882				
								RLE	0 204 125 878						
		OFD	01.10-10.12	66				LLE	0 204 709 901						
								RLE	0 204 709 899						

		S								
1.6	MFD	02.07-10.12	91				LLE,TW	0 204 125 879		
							RLE,TW	0 204 125 880		
		02.09-10.12	97				LLE	0 204 125 875		
							RLE	0 204 807 695		
		OFD	02.07-10.12				91	LLE,TW	0 204 125 882	
								RLE,TW	0 204 709 895	
	02.09-12.09	97	LLE	0 204 125 877						
			RLE	0 204 125 878						
	01.10-10.12	91/97	LLE	0 204 125 882						
			RLE	0 204 125 878						
	1.8	MFD	02.09-10.12	108				LLE	0 204 709 899	
								RLE	0 204 125 880	
OFD		02.09-12.09	108	LLE				0 204 125 880		
				RLE				0 204 125 882		
01.10-10.12		108	LLE	0 204 125 878						
			RLE	0 204 709 901						
01.10-10.12	93	LLE	0 204 709 901							
		RLE	0 204 125 880							
2.0D-4D	MFD	02.07-10.12	93				LLE	0 204 125 880		
							RLE	0 204 807 695		
	OFD	02.07-12.09	93				LLE	0 204 125 882		
							RLE	0 204 125 878		
	01.10-10.12	93	LLE				0 204 709 901			
			RLE				0 204 125 878			
01.10-10.12	93	LLE	0 204 125 880							
		RLE	0 204 807 695							
2.2D-CAT	02.07-10.12	130	LLE	0 204 125 880						
			RLE	0 204 807 695						
	1.4	02.07-03.09	71				F 026	A02 593		
	1.6	02.07-01.09	91				F 026	A06 570		
	1.3 WT-i	01.10-10.12	74					0 265 232 731 ^B		
								0 265 251 298 ^T		
	1.4	02.07-10.08	71					0 265 235 066 ^T		
	1.4 D-4D	02.07-10.08	66						0 265 235 066 ^T	
		01.10-10.12	66						0 265 232 731 ^B	
									0 265 251 298 ^T	
	1.6	02.07-10.08	91						0 265 235 066 ^T	
		01.10-10.12	91						0 265 232 731 ^B	
			97						0 265 251 298 ^T	
									0 265 232 731 ^B	
									0 265 251 298 ^T	
	1.8	01.10-10.12	108						0 265 232 731 ^B	
									0 265 251 298 ^T	
	2.0 D-4D	02.07-10.08	93						0 265 235 066 ^T	
		01.10-10.12	93						0 265 232 731 ^B	
									0 265 251 298 ^T	
	2.2 D-CAT	02.07-10.08	130						0 265 235 066 ^T	
		01.10-10.12	130						0 265 251 298 ^T	
	1.3 WT-i	11.08-10.12	74					0 265 005 854		
	1.4 , D-4D	02.07-10.12	66/71					0 265 005 854		
	1.6	02.07-10.12	91/97					0 265 005 854		
	1.8	02.09-10.12	108					0 265 005 854		
	2.0 D-4D	02.07-10.12	93					0 265 005 854		
	2.2 D-CAT	02.07-10.12	130					0 265 005 854		
Auris [E18]										
	1.3 WT-i	10.12→	74					0 204 793 199	23,81	
		MFD 10.12→	74					0 204 793 201	23,81	
		OFD 10.12→	74					0 204 793 200	23,81	



		S							
	◀ TOYOTA Auris [E18]								
	1.4 D-4D	10.12→	66			LLE	0 204 793 201	23,81	
						RLE	0 204 793 199	23,81	
	1.6	10.12→	97			LLE	0 204 793 201	23,81	
						RLE	0 204 793 199	23,81	
	2.0 D-4D	10.12→	93				0 204 793 201	23,81	
Auris Touring Sports [E18]									
	1.3	07.13→	73			RLE	0 204 793 199	23,81	
		MFD 07.13→	73			LLE	0 204 793 201	23,81	
		OFD 07.13→	73			LLE	0 204 793 200	23,81	
	1.4 D-4D	07.13→	66			LLE	0 204 793 201	23,81	
						RLE	0 204 793 199	23,81	
	1.6	07.13→	97			LLE	0 204 793 201	23,81	
						RLE	0 204 793 199	23,81	
	2.0 D-4D	07.13→	91				0 204 793 201	23,81	
Avalon									
	3.0 i 24V	ABO 09.94-08.96	141				F 026 A01 708		
		ABS 09.94-08.96	141				F 026 A01 707		
	3.0 i 24V	08.96-08.98	141				0 265 216 439 ^H		
Avensis Liftback [T22]									
	1.6 i 16V	05.99-01.03	74/81			JBH	0 986 480 871	23,8	
	1.8 i 16V	05.99-01.03	81/95			JBH	0 986 480 871	23,8	
	2.0 D Turbo, i 16V	05.99-01.03	66/85/94/110			JBH	0 986 480 871	23,8	
	1.6 i 16V	10.97-07.00	74/81			RLE	0 986 AB8 923	15,88	
	1.8 i 16V	10.97-07.00	81			RLE	0 986 AB8 923	15,88	
	2.0 i 16V	10.97-07.00	94			RLE	0 986 AB8 923	15,88	
	1.6 i 16V	10.97-07.00	74				F 026 A02 552		
			81				F 026 A02 552		
		07.00-01.03	81				F 026 A02 593		
	1.8 i 16V	10.97-07.00	81				F 026 A02 552		
		07.00-01.03	95				F 026 A02 593		
	2.0 D Turbo	10.97-01.03	66/85				F 026 A02 590		
	2.0 i 16V	10.97-01.03	94				F 026 A06 205		
		07.00-01.03	110				F 026 A06 031		
	1.6 i 16V	10.97-07.00	74/81				0 265 216 486 ^H		
		08.00-01.03	81				0 265 216 826 ^H		
	1.8 i 16V	10.97-07.00	81				0 265 216 486 ^H		
		08.00-01.03	95				0 265 216 826 ^H		
	2.0 D Turbo	10.97-07.00	66				0 265 216 486 ^H		
	2.0 D Turbo	10.97-07.00	85/94				0 265 216 486 ^H		
	2.0 i 16V	08.00-01.03	85/94				0 265 216 826 ^H		
	2.0 i 16V	08.00-01.03	110				0 265 216 826 ^H		
	1.6 i 16V	10.97-07.00	74/81				1 273 004 229 ^H		
		07.00-01.03	81				1 273 004 559 ^H		
	1.8 i 16V	10.97-07.00	81				1 273 004 229 ^H		
		07.00-01.03	95				1 273 004 559 ^H		
	2.0 D Turbo	10.97-07.00	66				1 273 004 229 ^H		
		07.00-01.03	85				1 273 004 559 ^H		

		S							
2.0i 16V		10.97-07.00	94				1 273 004 229 ^H		
		07.00-01.03	110				1 273 004 559 ^H		
		08.00-01.03	94				1 273 004 559 ^H		
Avensis Liftback [T25]									
									
	1.6i 16V	MFD	01.03-11.08	81		LLE	0 204 123 705		
						RLE	0 204 123 632		
		OFD	01.03-11.08	81		LLE	F 026 003 704	23,81	
						RLE	0 204 123 631		
	1.8i 16V	MFD	01.03-11.08	95		LLE	0 204 123 705		
						RLE	0 204 123 632		
		OFD	01.03-11.08	95		LLE	F 026 003 704	23,81	
						RLE	0 204 123 631		
	2.0D Turbo	MFD	03.03-04.06	85		LLE	0 204 123 705		
						RLE	0 204 123 632		
		OFD	03.03-04.06	85		LLE	F 026 003 704	23,81	
						RLE	0 204 123 631		
	2.0D-4D		04.06-11.08	93		LLE	0 204 123 705		
						RLE	0 204 123 632		
	2.0i 16V		01.03-11.08	108		LLE	F 026 003 704	23,81	
				114		RLE	0 204 123 632		
		MFD	01.03-11.08	114		LLE	0 204 123 705		
		OFD	01.03-11.08	114		LLE	F 026 003 704	23,81	
	2.2D-CAT		04.05-11.08	110/130		LLE	0 204 123 705		
	2.2D-4D					RLE	0 204 123 632		
	2.4i		09.03-11.08	120		LLE	0 204 123 705		
						RLE	0 204 123 632		
	1.6i 16V		01.03-11.08	81		LLE	0 204 125 809		
						RLE	0 204 125 810		
	1.8i 16V		01.03-11.08	95		LLE	0 204 125 809		
						RLE	0 204 125 810		
	2.0D Turbo, D-4D, i 16V		01.03-11.08	85/93/108/114		LLE	0 204 125 809		
						RLE	0 204 125 810		
	2.2D-CAT		04.05-11.08	110/130		LLE	0 204 125 809		
	2.2D-4D					RLE	0 204 125 810		
	2.4i		09.03-11.08	120		LLE	0 204 125 809		
						RLE	0 204 125 810		
	2.0D Turbo		03.03-04.06	85			0 986 486 519	20,6	
	2.0i 16V		01.03-11.08	108/114			F 026 A06 043		
	1.6i 16V		01.03-04.06	81			0 265 225 326 ^F		
			01.03-11.08	81			0 265 231 465 ^C		
			05.06-11.08	81			0 265 225 390 ^T		
	1.8i 16V		01.03-04.06	95			0 265 225 326 ^F		
			01.03-11.08	95			0 265 231 465 ^C		
			05.06-11.08	95			0 265 225 390 ^T		
	2.0D Turbo		03.03-05.03	85			0 265 225 282 ^T		
							0 265 231 328 ^F		
		MFD	06.03-04.06	85			0 265 225 326 ^F		
		OFD	06.03-04.06	85			0 265 231 465 ^C		
	2.0D-4D		04.06-11.08	93			0 265 225 388 ^T		
	2.0i 16V		01.03-04.06	114			0 265 225 326 ^F		
			01.03-11.08	108			0 265 231 465 ^C		
			05.06-11.08	114			0 265 225 388 ^T		
	2.2D-CAT		04.05-04.06	110/130			0 265 225 326 ^F		
	2.2D-4D		05.06-11.08	110/130			0 265 225 388 ^T		



TOYOTA Avensis Liftback [T25]

	2.4 i	09.03-04.06	120			0 265 225 326 ^F	
		05.06-11.08	120			0 265 225 388 ^T	
	1.6 i 16V	01.03-11.08	81			0 265 005 297	
	1.8 i 16V	01.03-11.08	95			0 265 005 297	
	2.0 D Turbo	03.03-04.06	85			0 265 005 273	
	2.0 D-4D, i 16V	01.03-11.08	93/114			0 265 005 297	
	2.2 D-CAT, D-4D	04.05-11.08	110/130			0 265 005 297	
	2.4 i	09.03-11.08	120			0 265 005 297	
	1.6 i 16V	01.03-11.08	81			0 265 005 487	
	1.8 i 16V	01.03-11.08	95			0 265 005 487	
	2.0 D Turbo, D-4D, i 16V	01.03-11.08	85/93/114			0 265 005 487	
	2.2 D-CAT, D-4D	04.05-11.08	110/130			0 265 005 487	
	2.4 i	09.03-11.08	120			0 265 005 487	

Avensis [T22]















	1.6 i 16V	05.99-01.03	74/81		JBH	0 986 480 871	23,8
	1.8 i 16V	05.99-01.03	81/95		JBH	0 986 480 871	23,8
	2.0 D Turbo, i 16V	05.99-01.03	66/85/94/110		JBH	0 986 480 871	23,8
	1.6 i 16V	10.97-07.00	74/81		RLE	0 986 AB8 923	15,88
	1.8 i 16V	10.97-07.00	81		RLE	0 986 AB8 923	15,88
	2.0 i 16V	10.97-07.00	94		RLE	0 986 AB8 923	15,88
	1.6 i 16V	10.97-07.00	74			F 026 A02 552	
			81			F 026 A02 552	
		07.00-01.03	81			F 026 A02 593	
	1.8 i 16V	10.97-07.00	81			F 026 A02 552	
		07.00-01.03	95			F 026 A02 593	
	2.0 D Turbo	10.97-01.03	66/85			F 026 A02 590	
	2.0 i 16V	10.97-01.03	94			F 026 A06 205	
		07.00-01.03	110			F 026 A06 031	
	1.6 i 16V	10.97-07.00	74/81			0 265 216 486 ^H	
		08.00-01.03	81			0 265 216 826 ^H	
	1.8 i 16V	10.97-07.00	81			0 265 216 486 ^H	
		08.00-01.03	95			0 265 216 826 ^H	
	2.0 D Turbo	10.97-07.00	66			0 265 216 486 ^H	
	2.0 D Turbo	10.97-07.00	85/94			0 265 216 486 ^H	
	2.0 i 16V	08.00-01.03	85/94			0 265 216 826 ^H	
	2.0 i 16V	08.00-01.03	110			0 265 216 826 ^H	
	1.6 i 16V	10.97-07.00	74/81			1 273 004 229 ^H	
		07.00-01.03	81			1 273 004 559 ^H	
	1.8 i 16V	10.97-07.00	81			1 273 004 229 ^H	
		07.00-01.03	95			1 273 004 559 ^H	
	2.0 D Turbo	10.97-07.00	66			1 273 004 229 ^H	
		07.00-01.03	85			1 273 004 559 ^H	
	2.0 i 16V	10.97-07.00	94			1 273 004 229 ^H	
		07.00-01.03	110			1 273 004 559 ^H	
		08.00-01.03	94			1 273 004 559 ^H	

Avensis [T25]



	1.6 i 16V	MFD	01.03-11.08	81		LLE	0 204 123 705	
						RLE	0 204 123 632	
		OFD	01.03-11.08	81		LLE	F 026 003 704	23,81
						RLE	0 204 123 631	

								
1.8i 16V	MFD	01.03-11.08	95			LLE	0 204 123 705	
						RLE	0 204 123 632	
	OFD	01.03-11.08	95			LLE	F 026 003 704	23,81
						RLE	0 204 123 631	
2.0D Turbo	MFD	03.03-04.06	85			LLE	0 204 123 705	
						RLE	0 204 123 632	
	OFD	03.03-04.06	85			LLE	F 026 003 704	23,81
						RLE	0 204 123 631	
2.0D-4D		04.06-11.08	93			LLE	0 204 123 705	
						RLE	0 204 123 632	
2.0i 16V		01.03-11.08	108			LLE	F 026 003 704	23,81
			114			RLE	0 204 123 632	
	MFD	01.03-11.08	114			LLE	0 204 123 705	
	OFD	01.03-11.08	114			LLE	F 026 003 704	23,81
2.2D-CAT		04.05-11.08	110/130			LLE	0 204 123 705	
2.2D-4D						RLE	0 204 123 632	
2.4i		09.03-11.08	120			LLE	0 204 123 705	
						RLE	0 204 123 632	
	1.6i 16V	01.03-11.08	81			LLE	0 204 125 809	
						RLE	0 204 125 810	
	1.8i 16V	01.03-11.08	95			LLE	0 204 125 809	
						RLE	0 204 125 810	
	2.0D Turbo, D-4D, i 16V	01.03-11.08	85/93/108			LLE	0 204 125 809	
						RLE	0 204 125 810	
	2.0i 16V	01.03-11.08	114			LLE	0 204 125 809	
						RLE	0 204 125 810	
	2.0i 16V 4WD	09.03-11.08	114				0 204 125 810	
	2.2D-CAT	04.05-11.08	110/130			LLE	0 204 125 809	
	2.2D-4D					RLE	0 204 125 810	
	2.4i	09.03-11.08	120			LLE	0 204 125 809	
						RLE	0 204 125 810	
	2.0D Turbo	03.03-04.06	85				0 986 486 519	20,6
	2.0i 16V	01.03-11.08	108/114				F 026 A06 043	
	1.6i 16V	01.03-04.06	81				0 265 225 326 ^F	
		01.03-11.08	81				0 265 231 465 ^C	
		05.06-11.08	81				0 265 225 390 ^T	
	1.8i 16V	01.03-04.06	95				0 265 225 326 ^F	
		01.03-11.08	95				0 265 231 465 ^C	
		05.06-11.08	95				0 265 225 390 ^T	
	2.0D Turbo	03.03-05.03	85				0 265 225 282 ^T	
							0 265 231 328 ^F	
	MFD	06.03-04.06	85				0 265 225 326 ^F	
	OFD	06.03-04.06	85				0 265 231 465 ^C	
	2.0D-4D	04.06-11.08	93				0 265 225 388 ^T	
	2.0i 16V	01.03-04.06	114				0 265 225 326 ^F	
		01.03-11.08	108				0 265 231 465 ^C	
		05.06-11.08	114				0 265 225 388 ^T	
	2.2D-CAT	04.05-04.06	110/130				0 265 225 326 ^F	
	2.2D-4D	05.06-11.08	110/130				0 265 225 388 ^T	
	2.4i	09.03-04.06	120				0 265 225 326 ^F	
		05.06-11.08	120				0 265 225 388 ^T	
	1.6i 16V	01.03-11.08	81				0 265 005 297	
	1.8i 16V	01.03-11.08	95				0 265 005 297	
	2.0D Turbo	03.03-04.06	85				0 265 005 273	
	2.0D-4D, i 16V	01.03-11.08	93/114				0 265 005 297	
	2.2D-CAT, D-4D	04.05-11.08	110/130				0 265 005 297	
	2.4i	09.03-11.08	120				0 265 005 297	



◀ TOYOTA Avensis [T25]

	1.6 i 16V	01.03-11.08	81			0 265 005 487	
	1.8 i 16V	01.03-11.08	95			0 265 005 487	
	2.0 D Turbo, D-4D, i 16V	01.03-11.08	85/93/114			0 265 005 487	
	2.2 D-CAT, D-4D	04.05-11.08	110/130			0 265 005 487	
	2.4 i	09.03-11.08	120			0 265 005 487	

Avensis [T27]



	1.6	MFD 11.08→	97	LLE	0 204 123 781	23,81
				RLE	0 204 123 779	23,81
		OFD 11.08→	97	LLE	0 204 123 780	23,81
				RLE	0 204 123 778	23,81
	1.8	11.08→	108	CVT,LLE	0 204 123 781	23,81
				CVT,LLE	0 204 123 782	22,2
				RLE	0 204 123 779	23,81
	2.0	11.08-04.11	112	LLE	0 204 123 780	23,81
				RLE	0 204 123 778	23,81
		11.08→	102	CVT,LLE	0 204 123 781	23,81
				CVT,LLE	0 204 123 782	22,2
				RLE	0 204 123 779	23,81
					112	CVT,LLE
			CVT,LLE	0 204 123 782	22,2	
			RLE	0 204 123 779	23,81	
	2.0 D-4D	11.08→	93	LLE	0 204 123 781	23,81
				RLE	0 204 123 779	23,81
	2.2 D-CAT	11.08→	110-130	LLE	0 204 123 781	23,81
	2.2 D-4D			RLE	0 204 123 779	23,81

	1.6	MFD 11.08→	97	LLE	0 204 125 915			
				RLE	0 204 125 913			
		OFD 11.08-05.10	97	LLE	0 204 125 914			
				RLE	0 204 125 912			
		06.10→	97	LLE	0 204 720 317			
				RLE	0 204 720 315			
	1.8	11.08→	108	LLE	0 204 125 915			
				RLE	0 204 125 913			
	2.0	11.08-05.10	112	LLE	0 204 125 914			
				RLE	0 204 125 912			
		11.08→	112	LLE	0 204 125 915			
				RLE	0 204 125 913			
				06.10-04.11	112	LLE	0 204 720 317	
						RLE	0 204 720 315	
	2.0	11.08→	93/102	LLE	0 204 125 915			
	2.0 D-4D			RLE	0 204 125 913			
	2.2 D-CAT	11.08→	110-130	LLE	0 204 125 915			
	2.2 D-4D			RLE	0 204 125 913			

	1.6	11.08-05.10	97		0 265 235 407 ^T	
		11.08-10.11	97		0 265 232 012 ^B	
		06.10-10.11	97		0 265 251 491 ^T	
	1.8	11.08-05.10	108		0 265 235 407 ^T	
		06.10-10.11	108		0 265 251 491 ^T	
	2.0	11.08-05.10	112		0 265 235 407 ^T	
		11.08-04.11	112		0 265 232 012 ^B	
		06.10-10.11	112		0 265 251 491 ^T	
	2.0	11.08-05.10	93/102		0 265 235 407 ^T	
	2.0 D-4D	06.10-10.11	93/102		0 265 251 491 ^T	
	2.2 D-CAT	11.08-05.10	110-130	GBM	0 265 235 407 ^T	
	2.2 D-4D	06.10-10.11	110-130	GBM	0 265 251 491 ^T	



	1.6	11.08-01.13	97			0 265 005 855	
	1.8	11.08-01.13	108			0 265 005 855	
	2.0, D-4D	11.08-01.13	93/102/112			0 265 005 855	
	2.2 D-CAT, D-4D	11.08-01.13	110-130			0 265 005 855	

Avensis Verso [M2]

	2.0 D Turbo	05.01-07.05	85			0 986 486 519	20,6
	2.0 i 16V	05.01→	110			F 026 A06 043	

Avensis Wagon [T22]

	1.6 i 16V	05.99-01.03	74/81	JBH		0 986 480 871	23,8
	1.8 i 16V	05.99-01.03	81/95	JBH		0 986 480 871	23,8
	2.0 D Turbo, i 16V	05.99-01.03	66/85/94/110	JBH		0 986 480 871	23,8

	1.6 i 16V	10.97-07.00	74/81	RLE		0 986 AB8 923	15,88
	1.8 i 16V	10.97-07.00	81	RLE		0 986 AB8 923	15,88
	2.0 i 16V	10.97-07.00	94	RLE		0 986 AB8 923	15,88

	1.6 i 16V	10.97-07.00	74/81			F 026 A02 552	
		07.00-01.03	81			F 026 A02 593	
	1.8 i 16V	10.97-07.00	81			F 026 A02 552	
		07.00-01.03	95			F 026 A02 593	
	2.0 D Turbo	10.97-01.03	66/85			F 026 A02 590	
	2.0 i 16V	10.97-01.03	94			F 026 A06 205	
		07.00-01.03	110			F 026 A06 031	

	1.6 i 16V	10.97-07.00	74/81			0 265 216 486^H	
		08.00-01.03	81			0 265 216 826^H	
	1.8 i 16V	10.97-07.00	81			0 265 216 486^H	
		08.00-01.03	95			0 265 216 826^H	
	2.0 D Turbo	10.97-07.00	66			0 265 216 486^H	
	2.0 D Turbo	10.97-07.00	85/94			0 265 216 486^H	
	2.0 i 16V	08.00-01.03	85/94			0 265 216 826^H	
	2.0 i 16V	08.00-01.03	110			0 265 216 826^H	

	1.6 i 16V	10.97-07.00	74			1 273 004 229^H	
			81			1 273 004 229^H	
		07.00-01.03	81			1 273 004 559^H	
	1.8 i 16V	10.97-07.00	81			1 273 004 229^H	
		07.00-01.03	95			1 273 004 559^H	
	2.0 D Turbo	10.97-07.00	66			1 273 004 229^H	
		07.00-01.03	85			1 273 004 559^H	
	2.0 i 16V	10.97-07.00	94			1 273 004 229^H	
		07.00-01.03	110			1 273 004 559^H	
		08.00-01.03	94			1 273 004 559^H	

Avensis Wagon [T25]

	1.6 i 16V	MFD 01.03-11.08	81	LLE		0 204 123 705	
				RLE		0 204 123 632	
		OFD 01.03-11.08	81	LLE		F 026 003 704	23,81
				RLE		0 204 123 631	
	1.8 i 16V	MFD 01.03-11.08	95	LLE		0 204 123 705	
				RLE		0 204 123 632	
		OFD 01.03-11.08	95	LLE		F 026 003 704	23,81
				RLE		0 204 123 631	



◀ TOYOTA Avensis Wagon [T25]										
2.0 D Turbo	MFD	03.03-04.06	85				LLE	0 204 123 705		
							RLE	0 204 123 632		
	OFD	03.03-04.06	85				LLE	F 026 003 704	23,81	
							RLE	0 204 123 631		
2.0 D-4D		04.06-11.08	93				LLE	0 204 123 705		
							RLE	0 204 123 632		
2.0 i 16V		01.03-11.08	108				LLE	F 026 003 704	23,81	
			114				RLE	0 204 123 632		
	MFD	01.03-11.08	114				LLE	0 204 123 705		
	OFD	01.03-11.08	114				LLE	F 026 003 704	23,81	
2.2 D-CAT		04.05-11.08	110/130				LLE	0 204 123 705		
2.2 D-4D							RLE	0 204 123 632		
2.4 i		09.03-11.08	120				LLE	0 204 123 705		
							RLE	0 204 123 632		
	1.6 i 16V		01.03-11.08	81			LLE	0 204 125 809		
							RLE	0 204 125 810		
	1.8 i 16V		01.03-11.08	95			LLE	0 204 125 809		
							RLE	0 204 125 810		
	2.0 D Turbo, D-4D, i 16V		01.03-11.08	85/93/108/114			LLE	0 204 125 809		
							RLE	0 204 125 810		
	2.2 D-CAT		04.05-11.08	110/130			LLE	0 204 125 809		
							RLE	0 204 125 810		
	2.4 i		09.03-11.08	120			LLE	0 204 125 809		
							RLE	0 204 125 810		
	2.0 D Turbo		03.03-04.06	85				0 986 486 519	20,6	
		2.0 i 16V		01.03-11.08	108/114			F 026 A06 043		
	1.6 i 16V		01.03-04.06	81				0 265 225 326 ^F		
			01.03-11.08	81				0 265 231 465 ^C		
			05.06-11.08	81				0 265 225 390 ^T		
	1.8 i 16V		01.03-04.06	95				0 265 225 326 ^F		
			01.03-11.08	95				0 265 231 465 ^C		
			05.06-11.08	95				0 265 225 390 ^T		
	2.0 D Turbo		03.03-05.03	85				0 265 225 282 ^T		
								0 265 231 328 ^F		
		MFD	06.03-04.06	85				0 265 225 326 ^F		
		OFD	06.03-04.06	85				0 265 231 465 ^C		
	2.0 D-4D		04.06-11.08	93				0 265 225 388 ^T		
	2.0 i 16V		01.03-04.06	114				0 265 225 326 ^F		
			01.03-11.08	108				0 265 231 465 ^C		
			05.06-11.08	114				0 265 225 388 ^T		
	2.2 D-CAT		04.05-04.06	110/130				0 265 225 326 ^F		
2.2 D-4D		05.06-11.08	110/130				0 265 225 388 ^T			
2.4 i		09.03-04.06	120				0 265 225 326 ^F			
		05.06-11.08	120				0 265 225 388 ^T			
	1.6 i 16V		01.03-11.08	81				0 265 005 297		
	1.8 i 16V		01.03-11.08	95				0 265 005 297		
	2.0 D Turbo		03.03-04.06	85				0 265 005 273		
	2.0 D-4D, i 16V		01.03-11.08	93/114				0 265 005 297		
	2.2 D-CAT, D-4D		04.05-11.08	110/130				0 265 005 297		
	2.4 i		09.03-11.08	120				0 265 005 297		
	1.6 i 16V		01.03-11.08	81				0 265 005 487		
	1.8 i 16V		01.03-11.08	95				0 265 005 487		
	2.0 D Turbo, D-4D, i 16V		01.03-11.08	85/93/114				0 265 005 487		
	2.2 D-CAT, D-4D		04.05-11.08	110/130				0 265 005 487		
	2.4 i		09.03-11.08	120				0 265 005 487		



Avensis Wagon [T27]























	1.6	MFD	11.08→	97	LLE	0 204 123 781	23,81	
					RLE	0 204 123 779	23,81	
		OFD	11.08→	97	LLE	0 204 123 780	23,81	
					RLE	0 204 123 778	23,81	
	1.8		11.08→	108	CVT,LLE	0 204 123 781	23,81	
						RLE	0 204 123 782	22,2
					CVT,LLE	0 204 123 779	23,81	
	2.0		11.08→	102/112	CVT,LLE	0 204 123 781	23,81	
						RLE	0 204 123 782	22,2
						RLE	0 204 123 779	23,81
	2.0D-4D		11.08→	93	LLE	0 204 123 781	23,81	
						RLE	0 204 123 779	23,81
	2.2D-CAT		11.08→	110-130	LLE	0 204 123 781	23,81	
	2.2D-4D				RLE	0 204 123 779	23,81	
<hr/>								
	1.6	MFD	11.08→	97	LLE	0 204 125 915		
					RLE	0 204 125 913		
		OFD	11.08-05.10	97	LLE	0 204 125 914		
					RLE	0 204 125 912		
			06.10→	97	LLE	0 204 720 317		
					RLE	0 204 720 315		
	1.8		11.08→	108	LLE	0 204 125 915		
						RLE	0 204 125 913	
	2.0		11.08→	93/102/	LLE	0 204 125 915		
					112	RLE	0 204 125 913	
	2.0D-4D				LLE	0 204 125 915		
	2.2D-CAT		11.08→	110-130	LLE	0 204 125 915		
	2.2D-4D				RLE	0 204 125 913		
<hr/>								
	1.6		11.08-05.10	97		0 265 235 407 ^T		
			11.08-10.11	97		0 265 232 012 ^B		
			06.10-10.11	97		0 265 251 491 ^T		
	1.8		11.08-05.10	108		0 265 235 407 ^T		
				06.10-10.11	108		0 265 251 491 ^T	
	2.0		11.08-05.10	93/102/112		0 265 235 407 ^T		
				06.10-10.11	93/102/112		0 265 251 491 ^T	
	2.0D-4D					0 265 251 491 ^T		
	2.2D-CAT		11.08-05.10	110-130	GBM	0 265 235 407 ^T		
	2.2D-4D		06.10-10.11	110-130	GBM	0 265 251 491 ^T		
<hr/>								
	1.6		11.08-01.13	97		0 265 005 855		
	1.8		11.08-01.13	108		0 265 005 855		
	2.0, D-4D		11.08-01.13	93/102/112		0 265 005 855		
	2.2D-CAT, D-4D		11.08-01.13	110-130		0 265 005 855		

Aygo

	1.0	MFD	02.05→	50	LLE	0 204 123 786	20,64
					RLE	0 204 123 786	20,64
		OFD	02.05→	50	LLE	0 204 123 667	20,6
					RLE	0 204 123 666	20,6
	1.4	MFD	05.05-09.10	40	LLE	0 204 123 786	20,64
						RLE	0 204 123 786
		OFD	05.05-09.10	40	LLE	0 204 123 667	20,6
					RLE	0 204 123 666	20,6
<hr/>							
	1.0	MFD	02.05→	50	LLE	0 204 125 831	
					RLE	0 204 125 830	
	1.4		05.05-09.10	40	LLE	0 204 125 831	
						RLE	0 204 125 830



◀ TOYOTA Aygo									
	1.0		02.05-01.12	50			0 265 231 580 ^B		
	1.4		05.05-09.10	40			0 265 231 580 ^B		
Aygo [B4]									
	1.0	MFD	05.14→	51	LLE		0 204 822 666	20,64	
					RLE		0 204 822 668	20,64	
		OFD	05.14→	51	LLE		0 204 822 665	20,64	
					RLE		0 204 822 667	20,64	
	1.2		05.14→	60	LLE		0 204 822 666	20,64	
					RLE		0 204 822 668	20,64	
Camry									
	2.0i		05.02-11.04	107			0 986 AB8 545	22,23	
	2.2i		10.96-12.02	95			F 026 A01 707		
	2.2		07.96-12.02	95/99-101			F 026 A02 590		
	2.2i								
	2.2i		10.96-12.02	95			0 265 216 631 ^B		
Camry Sedan									
	2.0i		11.92-10.97	92			0 986 480 810	23,8	F 026 A06 604 ⁶
			11.97-08.01	92					F 026 A06 604 ⁶
	2.2i		11.92-10.97	97			0 986 480 810	23,8	F 026 A06 604 ⁶
									F 026 A06 604 ⁶
	3.0i		11.97-02.03	138					F 026 A03 414 ⁶
		ABS	07.97-02.03	138			F 026 A01 707		
	3.0 Si	ABS	08.94-07.96	138					F 026 A03 414 ⁶
	2.0i		11.92-10.97	92			F 01G 09B 12K		
			11.97-08.01	92			F 01G 09B 24F		
	2.2i		11.92-10.97	97			F 01G 09B 12K		
	3.0i		11.97-02.03	138			F 01G 09B 1FW		
	3.0 Si		11.92-08.97	138			F 01G 09B 12K		
	2.4i		03.03-12.05	112			0 265 216 631 ^B		
	3.0i		07.97-12.05	138/141			0 265 216 631 ^B		
Camry [V1]									
	2.2i 16V	ABO	08.93-08.96	100-103					F 026 A03 415 ⁶
		ABS	08.93-08.96	100-103					F 026 A03 414 ⁶
	3.0i 24V	ABO	08.93-08.96	138					F 026 A03 415 ⁶
		ABS	08.93-08.96	138					F 026 A03 414 ⁶
	2.2i 16V		08.93-08.94	100-103	LLE		F 01G 09B 0VD		
			09.94-08.96	100-103	LLE		F 01G 09B 0VH		
					RLE		F 01G 09B 0VJ		
	3.0i 24V		08.93-08.94	138	LLE		F 01G 09B 0VD		
			09.94-08.96	138	LLE		F 01G 09B 0VH		
					RLE		F 01G 09B 0VJ		
	2.2i 16V		06.91-08.96	100-103	RLE		F 026 A01 854		

		S							
	2.2i 3.0i 24V	03.93-06.95 06.91-02.95	93 138				F 026 A07 697 F 026 A07 697		
Camry [V2]									
									
	2.2i 16V	08.96-09.01	96/100		14Z		F 026 A01 707		
	2.2i 16V 3.0i 24V	08.96-07.98 08.98-09.01 06.96-08.98	96/100 96/100 140/141		RLE RLE RLE,FKØ		F 01G 09B 1FW F 01G 09B 1FX F 01G 09B 1FW		
	2.2i 16V	08.96-09.01	96/100				F 026 A02 590		
	2.2i 3.0i	05.98-02.02 07.97-08.02	94 141				0 265 216 631^B 0 265 216 631^B		
Camry [V3]									
									
	2.0i 16V 2.4 2.4i, i 16V	08.01-01.06 ABO 08.02-08.09 ABS 08.02-08.09 08.01-01.06	118 123 123 112/113		AG,RLE AG AG,RLE		0 986 AB8 545 F 026 A06 921 F 026 A06 922 0 986 AB8 545	22,23	
	2.4 2.4i 2.4i 16V	08.02-06.06 08.02-08.09 08.01-01.06 08.01-01.06	112 123 113 112				F 026 A06 926 F 026 A06 926 F 026 A09 616 F 026 A09 616		
	2.4 2.4i 2.4i 16V	08.02-08.03 08.02-06.06 09.03-08.09 08.01-07.03 08.03-01.06 08.01-07.03 08.03-01.06	123 112 123 113 113 112 112		TW		F 026 A06 041 F 026 A06 041 F 026 A06 043 F 026 A06 043 F 026 A06 041 F 026 A06 043 F 026 A06 041 F 026 A06 043		
	2.4	08.02-06.06 08.02-08.09	112 123				0 265 216 631^H 0 265 216 631^B		
Camry [V4]									
									
	2.4i 2.4 VVT-i 3.5	06.06→ 01.06-08.11 01.06-08.11	123 123 204		TW AG,LLE AG,RLE GS,RLE LLE RLE		F 026 A06 486 0 204 023 300 0 204 023 305 0 204 023 340 0 204 023 677 0 204 053 254 0 204 023 302 0 204 023 301 0 204 053 254 0 204 023 302		
	2.4i 2.4 VVT-i	06.06→ 01.06-01.09	123 123		TW AG,RLE GS,RLE		0 204 748 131 0 204 023 140 0 204 023 139		



		S									
TOYOTA Camry [V4]											
	2.4 VVT-i	02.09-08.11	123				AG,LLE	0 204 053 360			
							AG,RLE	0 204 053 362			
							GS,LLE	0 204 053 359			
							GS,RLE	0 204 053 361			
	3.5	01.06-01.09	204				RLE	0 204 023 140			
							LLE	0 204 053 360			
		02.09-08.11	204					RLE	0 204 053 362		
	2.4 i, WT-i	01.06→	123					F 026 A05 936			
							2.5	02.06→	126-133		F 026 A05 936
	2.4 i, WT-i	01.06→	123					F 026 A06 043			
							2.5	02.06-03.09	126-133		F 026 A06 043
	2.4 i	06.06→	123					0 265 005 854			
							2.5	02.06→	126-133		0 265 005 854
Camry [V5]											
	2.5	08.11→	126-134					RLE	0 204 814 543		
	2.5	03.12-08.12	126-134					0 265 242 175 ^T			
							3.5	03.12-08.12	204		0 265 242 175 ^T
Camry [V40]											
	2.4 i	01.06-09.11	123					AG,LLE	0 204 053 254		
								AG,RLE	0 204 023 302		
								GS,RLE	0 204 023 301		
	2.4 i	MFD	01.06-01.09	123				RLE	0 204 023 140		
								LLE	0 204 053 360		
			02.09-09.11	123						RLE	0 204 053 362
										LLE	0 204 053 360
			01.06-01.09	123						RLE	0 204 023 139
										LLE	0 204 053 359
02.09-09.11	123						RLE	0 204 053 361			
	2.4 i	01.06-09.11	123					F 026 A05 936			
							2.4 i 4WD				
	2.4 i	01.06-09.11	123					F 026 A06 043			
							2.4 i 4WD				
Camry Wagon [V1]											
	2.2 i 16V	ABO	09.93-07.96	100-103					F 026 A03 415 ⁶		
			ABS	09.93-07.96	100-103				F 026 A03 414 ⁶		
	3.0 i 24V	ABO	09.93-08.96	138					F 026 A03 415 ⁶		
			ABS	08.93-08.96	138				F 026 A03 414 ⁶		
	2.2 i 16V		09.93-08.94	100-103			LLE	F 01G 09B 0VD			
			09.94-07.96	100-103			LLE	F 01G 09B 0VH			
							RLE	F 01G 09B 0VJ			
	3.0 i 24V		08.93-08.94	138			LLE	F 01G 09B 0VD			
			09.94-08.96	138			LLE	F 01G 09B 0VH			
							RLE	F 01G 09B 0VJ			



	2.2i16V		03.92-07.96	100-103		RLE	F 026 A01 854	
	3.0i24V		03.92-07.96	138		RLE	F 026 A01 854	
	3.0i24V		06.91-02.95	138			F 026 A07 697	

Camry [XV30]



	2.4i		09.01-01.06	117		AG,RLE	0 986 AB8 545	22,23
	2.4i		09.01-01.06	117			F 026 A09 616	
	2.4i		09.01-07.03	117			F 026 A06 041	
			08.03-01.06	117			F 026 A06 043	

Carina E Liftback [T19]



	1.6i16V	ABO	12.92-01.96	79/85		JBH,LLE	0 986 480 949	23,8
	2.0D	ABO	12.92-01.96	53-54/98/115-116/129		JBH,LLE	0 986 480 949	23,8
	2.0i16V			129				
	1.6i16V	ABS	02.94-01.96	79/85		RLE	F 01G 09B 02C	
	2.0i16V	ABS	02.94-01.96	98/115-116/129		RLE	F 01G 09B 02C	
	1.6i16V		02.92-10.97	75/79/85		RLE	0 986 AB8 923	15,88
	1.8i16V		12.94-10.97	79		RLE	0 986 AB8 923	15,88
	2.0i16V		02.92-10.97	98/115-116/129		RLE	0 986 AB8 923	15,88
	1.6i16V		02.92-10.97	75/79/85			F 026 A02 552	
	1.8i16V		12.94-10.97	79			F 026 A02 552	
	2.0D		02.92-01.96	53-54			0 986 486 519	20,6
			10.94-01.96	53-54			F 026 A06 205	
	2.0D Turbo		01.96-10.97	61			F 026 A06 205	
	2.0i16V		02.92-01.96	98		GLA	F 026 A02 590	
				115-116/129		GLA	F 026 A02 590	
			12.93-12.94	98			F 026 A02 590	
			01.95-10.97	98			F 026 A06 205	
	1.6i16V		01.95-10.97	75/79/85			0 265 214 001^H	
	1.8i16V		12.94-10.97	79			0 265 214 001^H	
	2.0D, D Turbo, i16V		01.95-10.97	53-54/61/98			0 265 214 001^H	
	1.6i16V		11.94-10.97	75/79/85		LLE	0 265 108 007^H	
						RLE	0 265 108 009^H	
	1.8i16V		12.94-10.97	79		LLE	0 265 108 007^H	
						RLE	0 265 108 009^H	
	2.0D		10.94-10.97	53-54/61		LLE	0 265 108 007^H	
	2.0D Turbo					RLE	0 265 108 009^H	
	2.0i16V		11.94-10.97	98		LLE	0 265 108 007^H	
						RLE	0 265 108 009^H	

Carina E Sedan [T19]

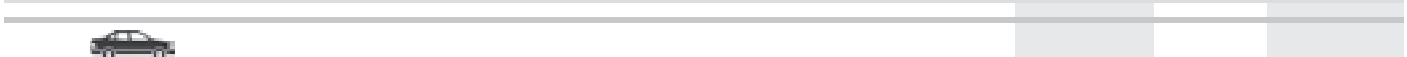

	1.6i16V	ABO	12.92-01.96	79/85		JBH,LLE	0 986 480 949	23,8
	2.0D	ABO	12.92-01.96	53-54/98/115-116/129		JBH,LLE	0 986 480 949	23,8
	2.0i16V			129				





◀ TOYOTA Carina E Sedan [T19]

	1.6 i 16V	ABS	02.94-01.96	79/85		RLE	F 01G 09B 0ZC	
	2.0 i 16V	ABS	02.94-01.96	98/115-116/129		RLE	F 01G 09B 0ZC	
	1.6 i 16V		02.92-10.97	75/79/85		RLE	0986 AB8 923	15,88
	1.8 i 16V		12.94-10.97	79		RLE	0986 AB8 923	15,88
	2.0 i 16V		02.92-10.97	98/115-116/129		RLE	0986 AB8 923	15,88
	1.6 i 16V		02.92-10.97	75/79/85			F 026 A02 552	
	1.8 i 16V		12.94-10.97	79			F 026 A02 552	
	2.0 D		02.92-01.96	53-54			0986 486 519	20,6
			10.94-01.96	53-54			F 026 A06 205	
	2.0 D Turbo		01.96-10.97	61			F 026 A06 205	
	2.0 i 16V		02.92-01.96	98/115-116/129		GLA	F 026 A02 590	
		12.92-12.94	98			F 026 A02 590		
		01.95-10.97	98			F 026 A06 205		
	1.6 i 16V		01.95-10.97	75/79/85			0265 214 001^H	
	1.8 i 16V		12.94-10.97	79			0265 214 001^H	
	2.0 D, D Turbo, i 16V		01.95-10.97	53-54/61/98			0265 214 001^H	
	1.6 i 16V		11.94-10.97	75/79/85		LLE	0265 108 007^H	
						RLE	0265 108 009^H	
	1.8 i 16V		12.94-10.97	79		LLE	0265 108 007^H	
						RLE	0265 108 009^H	
	2.0 D		10.94-10.97	53-54/61		LLE	0265 108 007^H	
	2.0 D Turbo					RLE	0265 108 009^H	
2.0 i 16V		11.94-10.97	98		LLE	0265 108 007^H		
					RLE	0265 108 009^H		

Carina E Wagon [T19]

















	1.6 i 16V	ABO	11.92-01.96	85		JBH,LLE	0986 480 949	23,8	
	1.8 i 16V	ABO	11.94-01.96	79		JBH,LLE	0986 480 949	23,8	
	2.0 D, i 16V	ABO	11.92-01.96	53-54/98		JBH,LLE	0986 480 949	23,8	
	1.6 i 16V	ABS	02.94-01.96	85		RLE	F 01G 09B 0ZC		
	1.8 i 16V	ABS	11.94-01.96	79		RLE	F 01G 09B 0ZC		
	2.0 i 16V	ABS	02.94-01.96	98		RLE	F 01G 09B 0ZC		
	1.6 i 16V		11.92-10.97	79/85		RLE	0986 AB8 923	15,88	
	1.8 i 16V		11.94-10.97	79		RLE	0986 AB8 923	15,88	
	2.0 i 16V		11.92-10.97	98		RLE	0986 AB8 923	15,88	
		1.6 i 16V		11.92-10.97	79/85			F 026 A02 552	
		1.8 i 16V		11.94-10.97	79			F 026 A02 552	
2.0 D			11.92-01.96	53-54			0986 486 519	20,6	
			05.95-01.96	53-54			F 026 A06 205		
2.0 D Turbo			01.96-10.97	61			F 026 A06 205		
2.0 i 16V			11.92-01.96	98		GLA	F 026 A02 590		
		05.95-10.97	98			F 026 A06 205			
	1.6 i 16V		05.95-10.97	79			0265 214 001^H		
	1.8 i 16V		05.95-10.97	79			0265 214 001^H		
	2.0 D, D Turbo, i 16V		05.95-10.97	53-54/61/98			0265 214 001^H		
	1.6 i 16V		05.95-10.97	79		LLE	0265 108 007^H		
						RLE	0265 108 009^H		
	1.8 i 16V		05.95-10.97	79		LLE	0265 108 007^H		
						RLE	0265 108 009^H		
	2.0 D, D Turbo, i 16V		05.95-10.97	53-54/61/98		LLE	0265 108 007^H		
						RLE	0265 108 009^H		

		S							
Celica Cabrio [T20]									
	2.0i 16V	ABO	08.94-12.95	129					F 026 A06 604 ⁶
		ABS	08.94-05.99	129		RLE	F 026 A01 668		
	2.0i 16V		08.94-05.99	129		RLE	F 026 A05 941		
Celica Coupé [T23]									
	1.8i 16V	MFD	09.02-11.03	105/140		LLE	F 01G 09C 1CC		
			12.03-09.05	105/140		RLE	F 01G 09C 1CB		
			08.99-11.03	105		LLE	F 01G 062 022		
			08.00-08.02	140		RLE	F 01G 062 021		
		OFD	08.99-11.03	105		LLE	F 01G 09C 1C8		
			12.03-09.05	105		RLE	F 01G 09C 1C7		
			08.00-08.02	140		LLE	F 01G 09C 1C8		
			12.03-09.05	105		RLE	F 01G 09C 1C7		
			08.00-08.02	140		LLE	F 01G 09C 1C8		
			12.03-09.05	105		RLE	F 01G 09C 1C7		
			08.00-08.02	140		LLE	F 01G 09C 1C8		
			12.03-09.05	105		RLE	F 01G 09C 1C7		
	1.8i 16V	MFD	08.02-09.05	105/140		LLE	F 01G 061 0FX		
			08.02-09.05	105/140		RLE	F 01G 061 04R		
		OFD	08.99-09.05	105/140		LLE	F 01G 09B 1S3		
			08.99-09.05	105/140		RLE	F 01G 09B 1RZ		
	1.8i 16V		08.99-09.05	105/140		LLE	F 026 A09 616		
	1.8i 16V		08.99-09.05	105/140			F 026 A07 633		
Celica Liftback [T20]									
	1.8i 16V	ABO	11.93-08.95	85					F 026 A06 604 ⁶
		ABS	11.93-08.99	85		RLE	F 026 A01 668		
	2.0i 16V	ABO	11.93-08.95	129					F 026 A06 604 ⁶
		ABS	11.93-08.99	129		RLE	F 026 A01 668		
	2.0i 16V Turbo, i 16V Turbo 4WD	ABS	02.94-08.95	178		RLE	F 026 A01 668		
	2.0i 16V Turbo 4WD	ABO	02.94-07.95	178					F 026 A06 604 ⁶
			08.95-06.96	178					F 026 A03 414 ⁶
	2.0i 16V Turbo 2.0i 16V Turbo 4WD		02.94-08.99	178		RLE	F 01G 09B 1A8		
	1.8i 16V		11.93-08.99	85		RLE	F 026 A05 941		
	2.0i 16V, i 16V Turbo, i 16V Turbo 4WD		11.93-08.99	129/178		RLE	F 026 A05 941		
	2.2i 16V		11.93-08.99	100		RLE	F 026 A05 941		
	1.8i 16V		11.93-08.99	85			F 026 A02 552		
	2.0i 16V Turbo 4WD		02.94-06.96	178			F 026 A06 205		
Century Sedan									
	5.0		10.98→	220		LLE	F 01G 09B 1GP		
						RLE	F 01G 09B 1GK		



		S							
◀ TOYOTA									
Condor									
	2.4 i		06.00-02.05	85					F 026 A03 421⁶
Condor Estate									
	1.8		06.00-06.03	65					F 026 A03 421⁶
	2.4 i		06.00-02.05	85					F 026 A03 421⁶
Corolla Altis									
	1.6 i		05.01-10.06	82		GS			F 026 A05 892
	1.8 i		03.99-01.08	101		AG,RLE			F 026 A01 730
	1.6 i		05.01-10.06	82		LLE			F 026 A09 616
						RLE			F 026 A05 948
	1.8 i		03.99-01.08	101		LLE			F 026 A09 616
	1.6 i		05.01-10.06	82					F 026 A02 593
	1.8 i		03.99-01.08	101					F 026 A02 593
Corolla [E9]									
	1.6 i		09.93-09.96	79					F 01G 09B 02L
Corolla [E10]									
	1.3 12V		05.92-05.95	55		JBH		0986	480 665 20,6
	1.6 i 16V	ABO	05.92-05.95	84-85		JBH,LLE		0986	480 665 20,6
		ABS	05.92-05.95	84-85		JBH,LLE		0986	480 681 22,2
			06.95-04.97	84-85		JBH,LLE		0986	480 990 22,2
	1.8 i 16V	ABO	09.92-05.95	77-85		JBH,LLE		0986	480 665 20,6
		ABS	09.92-05.95	77-85		JBH,LLE		0986	480 681 22,2
			06.95-08.97	77-85		JBH,LLE		0986	480 990 22,2
	1.3 12V		05.92-04.97	55				0986	486 143 15,87
	1.6 i 16V		05.92-04.97	84-85		LLE		0986	486 143 15,87
						RLE		F 026	A01 857
	1.8 i 16V		09.92-05.95	77-85		RLE		F 026	A01 857
			09.92-08.97	77-85		LLE		0986	486 143 15,87
	1.3 12V		05.92-09.95	55				0986	486 514 20,6
	1.6 i 16V		05.92-04.97	84-85				F 026	A02 552
	1.8 i 16V		09.92-08.97	77-85				F 026	A02 552
Corolla [E11]									
	1.3 i 16V	ABS	04.97-10.99	55-63		JBH,LLE		0986	480 990 22,2
	1.9 D	ABO	01.00-07.01	51		RLE		F 01G	09C 1D7
		ABS	08.00-07.01	51		RLE		F 01G	09C 1D8
	2.0 D	ABS	04.97-10.99	53		JBH,LLE		0986	480 990 22,2
	2.0 D Turbo		08.00-09.01	66		RLE		F 01G	09C 1D8



		S							
	1.3	09.96-08.99	55				F 01G 09B 0ZM		
	1.6 i	09.96-09.02	79				F 01G 09B 0ZL		
	1.3	04.97-07.01	53			LLE	0 986 486 143	15,87	
	1.3	04.97-11.04	54/55-63			LLE	0 986 486 143	15,87	
	1.3 i 16V					RLE	F 026 A01 857		
	1.9D	01.00-07.01	51			LLE	0 986 486 143	15,87	
	2.0D	04.97-10.99	53			LLE	0 986 486 143	15,87	
	2.0D Turbo	08.00-09.01	66			LLE	0 986 486 143	15,87	
	1.3, i 16V	04.97-11.04	53/54/55-63				0 986 486 569	22,2	
	2.0D	04.97-10.99	53				0 986 486 519	20,6	
	2.0D Turbo	08.00-09.01	66				F 026 A02 590		
Corolla [E12]									
									
	1.3 i	08.00-10.06	64-65			RLE	F 026 A05 892		
	1.4D Turbo	01.04-05.04	66			RLE	F 026 A05 892		
	1.4 i	09.02-07.07	71			TW	F 026 A05 892		
	1.4 i 16V	10.01-05.04	71			RLE	F 026 A05 892		
	1.5 i	08.00-10.06	80-81			AG	F 026 A01 730		
						GS	F 026 A05 892		
	1.6 i	09.02-07.07	81			TW	F 026 A05 892		
	1.6 i 16V	10.01-05.04	81			RLE	F 026 A05 892		
	1.8	08.00-08.08	93-108			AG,RLE	F 026 A01 730		
						GS,RLE	F 026 A05 892		
	1.8 i	08.00-10.06	97-100				F 026 A01 730		
		09.02-07.07	99			TW	F 026 A05 892		
	1.8 i RXi	09.02-07.07	141				F 026 A05 892		
	1.4 i 16V	10.01-05.04	71			LLE	F 01G 09B 1SE		
						RLE	F 01G 09B 1SC		
	1.6 i 16V	10.01-05.04	81			LLE	F 01G 09B 1SE		
						RLE	F 01G 09B 1SC		
	1.3 i	08.00-10.06	64-65			TW	F 026 A05 948		
							F 026 A09 616		
	1.4D Turbo	01.04-11.06	66			LLE	F 026 A09 616		
						RLE	F 026 A05 948		
	1.4 i	01.02-01.03	71			LLE	F 026 A09 616		
		09.02-07.07	71			RLE	F 026 A05 948		
	1.4 i 16V	10.01-11.06	71			LLE	F 026 A09 616		
						RLE	F 026 A05 948		
	1.5 i	08.00-10.06	80-81				F 026 A05 948		
	1.6 i	01.02-01.03	81			LLE	F 026 A09 616		
						RLE	F 026 A05 948		
	1.6 i 16V	10.01-11.06	81			LLE	F 026 A09 616		
						RLE	F 026 A05 948		
	1.8	08.00-08.08	93-108			LLE	F 026 A09 616		
						RLE	F 026 A05 948		
	2.0D Turbo	01.02-01.03	66			LLE	F 026 A09 616		
						RLE	F 026 A05 948		
	1.3 i	08.00-10.06	64-65				F 026 A02 402		
	1.4 i, i 16V	10.01-07.07	71				F 026 A02 593		
	1.6 i, i 16V	10.01-02.07	81				F 026 A02 593		
	1.8	08.00-08.08	93-108				F 026 A02 593		
	2.0D Turbo	01.02-02.07	66				0 986 486 519	20,6	





◀ TOYOTA Corolla [E12]

	1.4 D Turbo	01.04-02.07	66		0 265 216 851 ^H	
		08.04-02.07	66		0 265 225 291 ^T	
	1.4 i	01.02-02.07	71		0 265 225 287 ^T	
		01.02-07.07	71		0 265 216 851 ^H	
	1.4 i 16V	06.04-11.06	71		0 265 216 851 ^H	
	1.6 i	01.02-02.07	81		0 265 225 289 ^T	
		01.02-07.07	81		0 265 216 851 ^H	
	1.6 i 16V	06.04-11.06	81		0 265 216 851 ^H	
1.8 i	09.02-07.07	99		0 265 216 851 ^H		
2.0 D Turbo	01.02-02.07	66		0 265 216 851 ^H		
					0 265 225 289 ^T	
	1.6 i	09.02-07.07	81	TEI	1 273 004 571 ^H	
	1.8 i	09.02-07.07	99	TEI	1 273 004 571 ^H	
	1.4 D Turbo, i, i 16V	10.01-02.07	66/71		0 265 005 297	
	1.6 i, i 16V	10.01-02.07	81		0 265 005 297	
	2.0 D Turbo	01.02-02.07	66		0 265 005 297	
	1.4 D Turbo, i 16V	10.01-02.07	66/71		0 265 005 487	
	2.0 D Turbo	01.02-02.07	66		0 265 005 487	

Corolla [E14/E15]



	2.0 D-4D	MFD	11.06-03.08	93		0 204 123 755	22,2	
			04.08-02.10	93		0 204 123 804	22,2	
		OFD	11.06-03.08	93	LLE	0 204 123 756	22,2	
					RLE	0 204 123 754	22,2	
				04.08-02.10	93	LLE	0 204 123 805	
					RLE	0 204 123 803	22,2	
	2.0 D-4D	MFD	11.06-02.10	93		0 204 125 885		
		OFD	11.06-02.10	93	LLE	0 204 125 886		
					RLE	0 204 125 884		
	2.0 D-4D		11.06-02.10	93		0 265 005 854		
	2.0 D-4D		11.06-02.10	93		F 01G 065 00X		

Corolla [E15]



	1.4 D-4D	MFD	11.06-04.13	66		0 204 123 804	22,2
		OFD	11.06-03.08	66	RLE	0 204 123 754	22,2
			11.06-04.13	66	LLE	0 204 123 805	
			04.08-04.13	66	RLE	0 204 123 803	22,2
	1.4 VVT-i		11.06-12.08	71		0 204 123 799	22,2
1.8 i		09.07-03.10	100		0 204 123 799	22,2	
	1.4 D-4D	MFD	11.06-04.13	66		0 204 125 885	
		OFD	11.06-03.08	66	LLE	0 204 125 886	
			11.06-04.13	66	RLE	0 204 125 884	
			04.08-04.13	66	LLE	0 204 746 096	
	1.4 VVT-i		11.06-12.08	71		0 204 125 877	
1.8 i		09.07-03.10	100		0 204 125 877		
	1.3 VVT-i		12.08-04.13	74	RLE	F 026 A06 508	
	1.4 D-4D		11.06-04.13	66	RLE	F 026 A06 508	
	1.6, VVT-i		11.06-04.13	91/97	RLE	F 026 A06 508	



	1.6 VVT-i		11.06-11.08	91			F 026 A06 570	
	1.4 VVT-i		11.06-12.08	71			0 265 231 960^H	
	1.8 i		09.07-03.10	100			0 265 231 960^H	
	1.4 D-4D		11.06-04.13	66			0 265 005 854	
	1.4 D-4D		11.06-04.13	66			F 01G 065 00X	

Corolla [E18]

	1.3 VVT-i		06.13→	74	LLE		0 204 793 201	23,81
	1.4 D-4D		06.13→	66	RLE		0 204 793 199	23,81
	1.4 D-4D		06.13→	66	LLE		0 204 793 201	23,81
	1.4 D-4D		06.13→	66	RLE		0 204 793 199	23,81
	1.6	MFD	06.13→	91/97	BSS,LLE		0 204 793 201	23,81
	1.6 VVT-i		06.13→	91/97	BSS,RLE		0 204 793 199	23,81
	1.6 VVT-i	OFD	06.13→	91/97			0 204 793 200	23,81
	1.8 VVT-i	MFD	06.13→	100-103	BSS		0 204 793 201	23,81
	1.8 VVT-i	OFD	06.13→	100-103			0 204 793 200	23,81

Corolla Fielder

	1.5 i		08.00-10.06	80-81			F 026 A05 892	
	1.5 i		08.00-10.06	80-81			F 026 A05 948	
	1.5 i		08.00-10.06	80-81			F 026 A02 402	

Corolla Hatchback [E10]

	1.3 i 16V	ABO	05.92-05.95	65	JBH,LLE		0 986 480 665	20,6
	1.3 i 16V	ABS	05.92-05.95	65	JBH,LLE		0 986 480 681	22,2
	1.3 i 16V		05.95-04.97	55	JBH,LLE		0 986 480 990	22,2
	1.3 12V		05.92-05.95	55	JBH		0 986 480 665	20,6
	1.6 i 16V	ABO	05.92-05.95	84-85	JBH,LLE		0 986 480 665	20,6
	1.6 i 16V	ABS	05.92-05.95	84-85	JBH,LLE		0 986 480 681	22,2
	1.6 i 16V		06.95-04.97	84-85	JBH,LLE		0 986 480 990	22,2
	1.8 i 16V	ABO	11.92-05.95	86	JBH,LLE		0 986 480 665	20,6
	1.8 i 16V	ABS	11.92-05.95	86	JBH,LLE		0 986 480 681	22,2
	2.0 D	ABO	05.92-05.95	53-54	JBH,LLE		0 986 480 665	20,6
	2.0 D	ABS	05.92-05.95	53-54	JBH,LLE		0 986 480 681	22,2
	2.0 D		06.95-04.97	53-54	JBH,LLE		0 986 480 990	22,2
	1.3 i 16V		05.92-05.95	65	LLE		0 986 486 143	15,87
	1.3 i 16V		05.95-05.95	55	RLE		F 026 A01 857	
	1.3 i 16V		05.95-04.97	55	RLE		F 026 A01 857	
	1.3 12V		05.92-05.95	55	LLE		0 986 486 143	15,87
	1.6 i 16V		05.92-04.97	84-85	LLE		0 986 486 143	15,87
	1.6 i 16V		05.92-04.97	84-85	RLE		F 026 A01 857	



		S							
TOYOTA Corolla Hatchback [E10]									
	1.8 i 16V	11.92-05.95	86			LLE	0986 486 143	15,87	
						RLE	F 026 A01 857		
	2.0D	05.92-04.97	53-54			LLE	0986 486 143	15,87	
	1.3 i 16V	05.92-05.95	65				0986 486 514	20,6	
		10.95-04.97	55				0986 486 569	22,2	
	1.3 i 16V, 12V	05.92-09.95	55				0986 486 514	20,6	
	1.6 i 16V	05.92-04.97	84-85				F 026 A02 552		
	1.8 i 16V	11.92-05.95	86				F 026 A02 552		
	2.0D	05.92-04.97	53-54				0986 486 519	20,6	
Corolla Hatchback [E11]									
	1.3 i 16V	ABS 05.97-09.99	63			JBH,LLE	0986 480 990	22,2	
	1.6 i 16V	ABS 05.97-09.99	79-81			JBH,LLE	0986 480 990	22,2	
	1.9D	ABO 01.00-07.01	51			RLE	F 01G 09C 1D7		
		ABS 08.00-07.01	51			RLE	F 01G 09C 1D8		
	2.0D	ABS 05.97-09.99	53			JBH,LLE	0986 480 990	22,2	
	2.0D Turbo	08.00-07.01	66			RLE	F 01G 09C 1D8		
	1.3 i 16V	05.97-09.99	63			LLE	0986 486 143	15,87	
						RLE	F 026 A01 857		
	1.4 i 16V	10.99-07.01	71			LLE	0986 486 143	15,87	
						RLE	F 026 A01 857		
	1.6 i 16V	05.97-07.01	79-81			LLE	0986 486 143	15,87	
						RLE	F 026 A01 857		
	1.9D	01.00-07.01	51			LLE	0986 486 143	15,87	
	2.0D	05.97-09.99	53			LLE	0986 486 143	15,87	
2.0D Turbo	08.00-07.01	66			LLE	0986 486 143	15,87		
	1.3 i 16V	05.97-09.99	63				0986 486 569	22,2	
	1.4 i 16V	10.99-07.01	71				F 026 A02 593		
	1.6 i 16V	05.97-09.99	79-81				F 026 A02 552		
		10.99-07.01	81				F 026 A02 593		
	2.0D	05.97-09.99	53				0986 486 519	20,6	
	2.0D Turbo	08.00-07.01	66				F 026 A02 590		
Corolla Hatchback [E12]									
	1.4D Turbo, i 16V	11.01-05.04	66/71			RLE	F 026 A05 892		
	1.6 i 16V	11.01-05.04	81			RLE	F 026 A05 892		
	2.0D Turbo	OFD 11.01-05.04	66/81-85			RLE	F 026 A05 892		
	1.4 i 16V	11.01-05.04	71			LLE	F 01G 09B 1SE		
						RLE	F 01G 09B 1SC		
	1.6 i 16V	11.01-05.04	81			LLE	F 01G 09B 1SE		
						RLE	F 01G 09B 1SC		
	2.0D Turbo	11.01-05.04	66/81-85			LLE	F 01G 09B 1SF		
						RLE	F 01G 09B 1SD		
	1.4D Turbo	11.01-12.07	66/71			LLE	F 026 A09 616		
	1.4 i 16V					RLE	F 026 A05 948		
	1.6 i 16V	11.01-02.07	81			LLE	F 026 A09 616		
						RLE	F 026 A05 948		
	1.8 i 16V	11.01-01.03	140-165			LLE	F 026 A09 616		
						RLE	F 026 A05 948		
	2.0D Turbo	11.01-05.04	66/81-85			LLE	F 026 A09 616		
					RLE	F 026 A05 948			
	1.4 i 16V	11.01-12.07	71				F 026 A02 593		
	1.6 i 16V	11.01-02.07	81				F 026 A02 593		

		S							
	1.8i 16V						F 026 A02 593		
	2.0D Turbo						0 986 486 519	20,6	
	1.4D Turbo						0 265 225 291 ^T		
		09.02-12.07	66				0 265 216 851 ^H		
	1.4i 16V	06.04-12.07	71				0 265 216 851 ^H		
							0 265 225 287 ^T		
	1.6i 16V	06.04-02.07	81				0 265 216 851 ^H		
							0 265 225 289 ^T		
	1.8i 16V	11.01-05.04	140-165				0 265 225 262 ^M		
		06.04-12.07	140-165				0 265 225 293 ^T		
	1.4D Turbo, i 16V	11.01-12.07	66/71				0 265 005 297		
	1.6i 16V	11.01-02.07	81				0 265 005 297		
	1.8i 16V	11.01-05.04	140-165				0 265 005 273		
		06.04-12.07	140-165				0 265 005 297		
	1.4D Turbo, i 16V	11.01-12.07	66/71				0 265 005 487		
	1.8i 16V	11.01-12.07	140-165				0 265 005 487		
Corolla Liftback [E10]									
	1.3i 16V	ABO 05.92-05.95	65			JBH,LLE	0 986 480 665	20,6	
		ABS 05.92-05.95	65			JBH,LLE	0 986 480 681	22,2	
	1.3 12V	05.92-05.95	55			JBH	0 986 480 665	20,6	
	1.6i 16V	ABO 05.92-05.95	84-85			JBH,LLE	0 986 480 665	20,6	
		ABS 05.92-05.95	84-85			JBH,LLE	0 986 480 681	22,2	
	1.8i 16V	ABO 11.92-05.95	86			JBH,LLE	0 986 480 665	20,6	
		ABS 11.92-05.95	86			JBH,LLE	0 986 480 681	22,2	
	2.0D	ABO 05.92-05.95	53-54			JBH,LLE	0 986 480 665	20,6	
		ABS 05.92-05.95	53-54			JBH,LLE	0 986 480 681	22,2	
	1.3i 16V	05.92-05.95	65			LLE	0 986 486 143	15,87	
						RLE	F 026 A01 857		
	1.3 12V	05.92-05.95	55				0 986 486 143	15,87	
	1.6i 16V	05.92-05.95	84-85			LLE	0 986 486 143	15,87	
						RLE	F 026 A01 857		
	1.8i 16V	11.92-05.95	86			LLE	0 986 486 143	15,87	
						RLE	F 026 A01 857		
	2.0D	05.92-05.95	53-54			LLE	0 986 486 143	15,87	
	1.3i 16V, 12V	05.92-05.95	55/65				0 986 486 514	20,6	
	1.6i 16V	05.92-05.95	84-85				F 026 A02 552		
	1.8i 16V	11.92-05.95	86				F 026 A02 552		
	2.0D	05.92-05.95	53-54				0 986 486 519	20,6	
Corolla Liftback [E11]									
	1.3i 16V	ABS 05.97-09.99	63			JBH,LLE	0 986 480 990	22,2	
	1.6i 16V	ABS 05.97-09.99	79-81			JBH,LLE	0 986 480 990	22,2	
	1.9D	ABO 12.99-11.01	51			RLE	F 01G 09C 1D7		
		ABS 08.00-11.01	51			RLE	F 01G 09C 1D8		
	2.0D	ABS 05.97-09.99	53			JBH,LLE	0 986 480 990	22,2	
	2.0D Turbo	08.00-09.01	66			RLE	F 01G 09C 1D8		
	1.3i 16V	05.97-11.99	63/79			LLE	0 986 486 143	15,87	
						RLE	F 026 A01 857		
	1.4i 16V	10.99-11.01	71			LLE	0 986 486 143	15,87	
						RLE	F 026 A01 857		
	1.6i 16V	05.97-11.01	79-81			LLE	0 986 486 143	15,87	
						RLE	F 026 A01 857		



		S							
TOYOTA Corolla Liftback [E11]									
	1.9D	12.99-11.01	51			LLE	0986 486 143	15,87	
	2.0D	05.97-09.99	53			LLE	0986 486 143	15,87	
		12.99-11.01	51			LLE	0986 486 143	15,87	
	2.0D Turbo	08.00-09.01	66			LLE	0986 486 143	15,87	
	1.3 i 16V	05.97-11.99	63				0986 486 569	22,2	
		09.98-11.99	79				F 026 A02 552		
	1.4 i 16V	10.99-11.01	71				F 026 A02 593		
	1.6 i 16V	05.97-09.99	79-81				F 026 A02 552		
		10.99-11.01	81				F 026 A02 593		
	2.0D	05.97-09.99	53				0986 486 519	20,6	
	2.0D Turbo	08.00-09.01	66				F 026 A02 590		
Corolla RunX [E12]									
	1.4 i	09.02-07.07	71			TW	F 026 A05 892		
	1.6 i	09.02-07.07	81			TW	F 026 A05 892		
	1.8 i	08.04-07.07	99			TW	F 026 A05 892		
	1.4 i	09.02-07.07	71				F 026 A05 948		
	1.4 i	09.02-07.07	71				F 026 A02 593		
	1.4 i	09.02-07.07	71				0 265 216 851 ^H		
	1.6 i	09.02-07.07	81				0 265 216 851 ^H		
	1.8 i	08.04-07.07	99				0 265 216 851 ^H		
	1.6 i	09.02-07.07	81			TEI	1 273 004 571 ^H		
	1.8 i	08.04-07.07	99			TEI	1 273 004 571 ^H		
Corolla Sedan									
	1.6	04.07-02.15	81				F 026 A02 593		
	1.8	04.07→	97				F 026 A02 593		
Corolla Sedan [E10]									
	1.3 i 16V	ABO 05.92-05.95	55-65			JBH,LLE	0986 480 665	20,6	
		ABS 05.92-05.95	55-65			JBH,LLE	0986 480 681	22,2	
		06.95-04.97	55-65			JBH,LLE	0986 480 990	22,2	
	2.0D	ABO 05.92-05.95	53-54			JBH,LLE	0986 480 665	20,6	
		ABS 05.92-05.95	53-54			JBH,LLE	0986 480 681	22,2	
		06.95-04.97	53-54			JBH,LLE	0986 480 990	22,2	
	1.3 i 16V	05.92-05.95	55-65			RLE	F 026 A01 857		
		05.92-04.97	55-65			LLE	0986 486 143	15,87	
	2.0D	05.92-04.97	53-54			LLE	0986 486 143	15,87	
	1.3 i 16V	05.92-09.95	55-65				0986 486 514	20,6	
		10.95-04.97	55-65				0986 486 569	22,2	
	2.0D	05.92-04.97	53-54				0986 486 519	20,6	
Corolla Sedan [E11]									
	1.6 i 16V	ABS 04.97-10.99	79-81			JBH,LLE	0986 480 990	22,2	



		S							
	1.4i 16V	10.99-09.01	71			LLE	0 986 486 143	15,87	
						RLE	F 026 A01 857		
	1.6i 16V	04.97-09.01	79-81			LLE	0 986 486 143	15,87	
						RLE	F 026 A01 857		
	1.4i 16V	10.99-09.01	71				F 026 A02 593		
	1.6i 16V	04.97-10.99	79-81				F 026 A02 552		
		10.99-09.01	81				F 026 A02 593		
Corolla Sedan [E12]									
	2.0D Turbo	10.01-05.04	82				RLE	F 026 A05 892	
	2.0D Turbo	10.01-05.04	82			LLE	F 01G 09B 1SF		
						RLE	F 01G 09B 1SD		
	1.6i 16V	05.02-03.08	81				F 026 A09 616		
	1.8i 16V	05.02-03.08	97-100				F 026 A09 616		
	2.0D Turbo	10.01-05.04	82			LLE	F 026 A09 616		
						RLE	F 026 A05 948		
	2.0D Turbo	10.01-05.04	82				0 986 486 519	20,6	
	1.8i 16V	08.02-03.08	97-100				0 265 216 851^H		
Corolla Verso [E12]									
	1.6i 16V	09.01-01.04	81				RLE	F 026 A05 892	
	2.0D Turbo	09.01-01.04	66				RLE	F 026 A05 892	
	1.6i 16V	09.01-01.04	81				RLE	F 01G 09B 1SC	
	1.8i 16V	09.01-01.04	99				RLE	F 01G 09B 1SC	
	2.0D Turbo	09.01-01.04	66			LLE	F 01G 09B 1SF		
						RLE	F 01G 09B 1SD		
	1.6i 16V	09.01-01.04	81			LLE	F 026 A09 616		
						RLE	F 026 A05 948		
	1.8i 16V	09.01-01.04	99			LLE	F 026 A09 616		
						RLE	F 026 A05 948		
	2.0D Turbo	09.01-01.04	66			LLE	F 026 A09 616		
						RLE	F 026 A05 948		
	1.6i 16V	09.01-01.04	81				F 026 A02 593		
	1.8i 16V	09.01-01.04	99				F 026 A02 593		
	2.0D Turbo	09.01-01.04	66				0 986 486 519	20,6	
Corolla Verso [R1]									
	1.6i 16V	MFD	02.04-02.09	81		LLE	0 204 123 707	23,8	
						RLE	0 204 123 657	23,8	
		OFD	02.04-02.09	81		LLE	0 204 123 706	23,8	
						RLE	0 204 123 656	23,8	
	1.8i 16V	MFD	02.04-02.09	95		LLE	0 204 123 707	23,8	
						RLE	0 204 123 657	23,8	
	OFD	02.04-02.09	95		LLE	0 204 123 706	23,8		
					RLE	0 204 123 656	23,8		























		S							
TOYOTA Corolla Verso [R1]									
	2.0 D Turbo	MFD	02.04-08.05	85		LLE	0 204 123 707	23,8	
						RLE	0 204 123 657	23,8	
		OFD	02.04-08.05	85		LLE	0 204 123 706	23,8	
						RLE	0 204 123 656	23,8	
	2.2 D-CAT	MFD	08.05-02.09	100/130		LLE	0 204 123 707	23,8	
	2.2 D-4D					RLE	0 204 123 657	23,8	
		OFD	08.05-02.09	100/130		LLE	0 204 123 706	23,8	
						RLE	0 204 123 656	23,8	
	1.6 i 16V		02.04-02.09	81		LLE	0 204 125 809		
						RLE	0 204 125 810		
	1.8 i 16V		02.04-02.09	95		LLE	0 204 125 809		
						RLE	0 204 125 810		
	2.0 D Turbo		02.04-08.05	85		LLE	0 204 125 809		
						RLE	0 204 125 810		
2.2 D-CAT		08.05-02.09	100/130		LLE	0 204 125 809			
2.2 D-4D					RLE	0 204 125 810			
	2.0 D Turbo		02.04-08.05	85			0 986 486 519	20,6	
	1.6 i 16V		02.04-02.09	81			0 265 225 285 ^T		
							0 265 231 485 ^B		
	1.8 i 16V		02.04-02.09	95			0 265 225 285 ^T		
							0 265 231 485 ^B		
	2.0 D Turbo		02.04-08.05	85			0 265 225 285 ^T		
							0 265 231 485 ^B		
2.2 D-CAT		08.05-02.09	100/130			0 265 231 485 ^B			
2.2 D-4D							0 265 234 223 ^T		
	1.6 i 16V		02.04-02.09	81			0 265 005 297		
	1.8 i 16V		02.04-02.09	95			0 265 005 297		
	2.0 D Turbo		02.04-08.05	85			0 265 005 297		
	2.2 D-CAT, D-4D		08.05-02.09	100/130			0 265 005 297		
	1.6 i 16V		02.04-02.09	81		TW	0 265 005 487		
	1.8 i 16V		02.04-02.09	95		TW	0 265 005 487		
	2.0 D Turbo		02.04-08.05	85		TW	0 265 005 432		
	2.2 D-CAT, D-4D		08.05-02.09	100/130			0 265 005 487		
Corolla Verso [R2]									
	1.6 D4D-D		01.14→	82		LLE	0 204 123 796		
						RLE	0 204 123 795		
	1.6 i	MFD	02.09→	97		LLE	0 204 123 796		
						RLE	0 204 123 795		
		OFD	02.09→	97		LLE	0 204 123 794		
						RLE	0 204 123 793	22	
	1.8 VWT-i		02.09→	108		RLE	0 204 123 795		
						5SP,LLE	0 204 123 796		
						7SP,LLE	0 204 123 797		
	2.0 D-4D		02.09→	93		LLE	0 204 123 796		
						RLE	0 204 123 795		
	2.2 D-CAT		02.09→	110-130		LLE	0 204 123 796		
						RLE	0 204 123 795		
		1.6 i	OFD	02.09→	97		LLE	0 204 744 239	
						RLE	0 204 744 237		
	1.6 i		02.09-10.12	97			0 265 251 489 ^T		
	1.8 VWT-i		02.09-10.12	108			0 265 251 489 ^T		

		S							
	2.0 D-4D	02.09-10.12	93						0 265 251 489 ^T
	2.2 D-CAT	02.09-10.12	110-130						0 265 251 489 ^T
	1.6 i	02.09-10.12	97						0 265 005 855
	1.8 VVT-i	02.09-10.12	108						0 265 005 855
	2.0 D-4D	02.09-10.12	93						0 265 005 855
	2.2 D-CAT	02.09-10.12	110-130						0 265 005 855
Corolla Verso [R10/11]									
	1.6 i 16V	02.10→	97				CVT,LLE		0 204 123 796
							CVT,LLE		0 204 123 797
							RLE		0 204 123 795
	1.6 i 16V	02.10→	97				TW		0 265 251 489 ^T
	1.6 i 16V	02.10→	97						0 265 005 855
Corolla Verso [R11]									
	1.8 i 16V	MFD 02.04→	97				LLE		0 204 123 707
							RLE		0 204 123 657
		OFD 02.04→	97				LLE		0 204 123 706
							RLE		0 204 123 656
	1.8 i 16V	02.04→	97				LLE		0 204 125 809
							RLE		0 204 125 810
	1.8 i 16V	02.04→	97						0 265 225 285 ^T
									0 265 231 485 ^B
	1.8 i 16V	02.04→	97						0 265 005 297
	1.8 i 16V	02.04→	97				TW		0 265 005 487
		06.07→	97						0 265 005 487
Corolla Wagon									
	1.8 i 16V Fielder	05.04-12.07	100						F 026 A09 616
	1.8 i 16V Fielder	05.04-12.07	100						0 265 216 851 ^H
Corolla Wagon [E10]									
	1.3 i 16V	ABO 05.92-05.95	55-65				JBH,LLE		0 986 480 665
		ABS 05.92-05.95	55-65				JBH,LLE		0 986 480 681
		06.95-04.97	55-65				JBH,LLE		0 986 480 990
	1.3 12V	05.92-05.95	55				JBH,TW		0 986 480 665
							TW		F 026 A01 637
									0 986 AB8 540
	1.6 i 16V	ABO 05.92-05.95	84-85				JBH,LLE		0 986 480 665



		S							
TOYOTA Corolla Wagon [E10]									
	1.6 i 16V	ABS	05.92-05.95	84-85		JBH,LLE	0986 480 681	22,2	
			06.95-04.97	84-85		JBH,LLE	0986 480 990	22,2	
	1.8 4x4	ABS	05.95-04.97	81		JBH,LLE	0986 480 990	22,2	
	2.0 D	ABO	05.92-05.95	53-54		JBH,LLE	0986 480 665	20,6	
			ABS	05.92-05.95	53-54		JBH,LLE	0986 480 681	22,2
			05.95-04.97	53-54		JBH,LLE	0986 480 990	22,2	
	1.3 12V		05.92-05.95	55		TW	F 01G 09B 0ZG		
	1.3 i 16V		05.92-05.95	55-65		RLE	F 026 A01 857		
			05.92-04.97	55-65		LLE	0986 486 143	15,87	
	1.3 12V		05.92-05.95	55		RLE	F 026 A01 857		
	1.6 i 16V		05.92-04.97	84-85		LLE	0986 486 143	15,87	
						RLE	F 026 A01 857		
	1.8 4x4		05.95-04.97	81			0986 486 143	15,87	
	2.0 D		05.92-04.97	53-54		LLE	0986 486 143	15,87	
	1.3 i 16V		05.92-09.95	55-65			0986 486 514	20,6	
			10.95-04.97	55-65			0986 486 569	22,2	
	1.3 12V		05.92-05.95	55			0986 486 514	20,6	
	1.6 i 16V		05.92-04.97	84-85			F 026 A02 552		
	1.8 4x4		05.95-04.97	81			F 026 A02 552		
	2.0 D		05.92-04.97	53-54			0986 486 519	20,6	
Corolla Wagon [E11]									
	1.3 i 16V	ABS	04.97-10.99	63		JBH,LLE	0986 480 990	22,2	
			1.6 i 16V	ABS	04.97-10.99	79-81		JBH,LLE	0986 480 990
	1.8 i 16V 4x4	ABS	04.97-07.01	81		JBH	0986 480 990	22,2	
	1.9 D 4x4	ABO	01.00-07.01	51		RLE	F 01G 09C 1D7		
			ABS	08.00-07.01	51		RLE	F 01G 09C 1D8	
	2.0 D Turbo		08.00-09.01	66		RLE	F 01G 09C 1D8		
	2.0 D 4x4	ABS	04.97-10.99	53		JBH,LLE	0986 480 990	22,2	
	1.3 i 16V		04.97-10.99	63		LLE	0986 486 143	15,87	
						RLE	F 026 A01 857		
	1.4 i 16V		10.99-09.01	71		LLE	0986 486 143	15,87	
						RLE	F 026 A01 857		
	1.6 i 16V		04.97-09.01	79-81		LLE	0986 486 143	15,87	
						RLE	F 026 A01 857		
	1.8 i 16V 4x4		04.97-07.01	81		LLE	0986 486 143	15,87	
	1.9 D 4x4		01.00-07.01	51		LLE	0986 486 143	15,87	
	2.0 D Turbo		08.00-09.01	66		LLE	0986 486 143	15,87	
	2.0 D 4x4		04.97-10.99	53		LLE	0986 486 143	15,87	
	1.3 i 16V		04.97-10.99	63			0986 486 569	22,2	
		1.4 i 16V		10.99-09.01	71			F 026 A02 593	
	1.6 i 16V		04.97-10.99	79-81			F 026 A02 552		
			10.99-09.01	81			F 026 A02 593		
	1.8 i 16V 4x4		04.97-07.01	81			F 026 A02 552		
	2.0 D Turbo		08.00-09.01	66			F 026 A02 590		
	2.0 D 4x4		04.97-10.99	53			0986 486 519	20,6	
Corolla Wagon [E12]									
	1.4 i 16V		10.01-05.04	71		RLE	F 026 A05 892		
		1.6 i 16V		10.01-05.04	81		RLE	F 026 A05 892	
	1.8 i 16V		08.00-12.06	99		AG,RLE	F 026 A01 730		
					GS,RLE	F 026 A05 892			
	2.0 D Turbo	OFD	10.01-05.04	66-85		RLE	F 026 A05 892		

		S							
	1.4 i 16V	10.01-05.04	71			LLE	F 01G 09B 1SE		
						RLE	F 01G 09B 1SC		
	1.6 i 16V	10.01-05.04	81			LLE	F 01G 09B 1SE		
						RLE	F 01G 09B 1SC		
	2.0 D Turbo	10.01-05.04	66-85			LLE	F 01G 09B 1SF		
						RLE	F 01G 09B 1SD		
	1.4 i	08.02-01.03	71			LLE	F 026 A09 616		
						RLE	F 026 A05 948		
	1.4 i 16V	10.01-11.06	71			LLE	F 026 A09 616		
						RLE	F 026 A05 948		
	1.6 i	08.02-01.03	81			LLE	F 026 A09 616		
						RLE	F 026 A05 948		
	1.6 i 16V	10.01-11.06	81			LLE	F 026 A09 616		
						RLE	F 026 A05 948		
	1.8 i 16V	08.00-12.06	99			LLE	F 026 A09 616		
						RLE	F 026 A05 948		
	2.0 D Turbo	10.01-05.04	66-85			LLE	F 026 A09 616		
						RLE	F 026 A05 948		
	1.4 i, i 16V	10.01-02.07	71				F 026 A02 593		
	1.6 i, i 16V	10.01-02.07	81				F 026 A02 593		
	1.8 i 16V	08.00-12.06	99				F 026 A02 593		
	2.0 D Turbo	10.01-02.07	66-85				0 986 486 519	20,6	
	1.4 D Turbo	04.04-02.07	66				0 265 216 851^H		
							0 265 225 291^T		
	1.4 i	08.02-02.07	71				0 265 216 851^H		
							0 265 225 287^T		
	1.4 i 16V	06.04-11.06	71				0 265 216 851^H		
	1.6 i	08.02-02.07	81				0 265 216 851^H		
							0 265 225 289^T		
	1.6 i 16V	06.04-11.06	81				0 265 216 851^H		
2.0 D Turbo	08.02-02.07	66-85				0 265 216 851^H			
						0 265 225 289^T			
	1.4 D Turbo, i, i 16V	10.01-02.07	66/71				0 265 005 297		
	1.6 i, i 16V	10.01-02.07	81				0 265 005 297		
	2.0 D Turbo	08.02-02.07	66-85				0 265 005 297		
	1.4 D Turbo, i 16V	10.01-02.07	66/71				0 265 005 487		
	2.0 D Turbo	08.02-02.07	66-85				0 265 005 487		
Cressida Sedan [X8]									
									
	2.4 D	08.88-08.96	62				F 01G 09B ORR		
	2.8 i	08.88-08.96	95				F 01G 09B OTD		
Crown [S13]									
									
	3.0 i	08.89-10.95	140				F 01G 09B OV6		
Dyna									
									
	4.0	12.95-04.99	70				F 026 A07 130		
	4.6 D	10.00-06.02	96				F 026 A07 100		
		10.01-02.08	108			TW	F 01G 062 030		



		S							
	◀ TOYOTA Dyna								
	5-103	12.95-04.03	72				F 026 A07 130		
	6-094 3.0	10.86-12.95					F 026 A01 642		F 026 A07 980 ⁶
	6-104/5 4.0	05.03→	77				F 026 A07 100		
	7-145 4.1	05.99-04.03	100				F 026 A07 130		
	4.6 D	10.00-06.02	96				F 01G 09B 1NB		
		10.01-02.08	108		TW		F 01G 09B 1NE		
							F 01G 09B 1NF		
	5-103	12.95-04.03	72				F 01G 09B 12V		
	6-104/5 4.0	05.03→	77				F 01G 09B 1NB		
	7-145	03.08→	110				F 01G 09B 1NF		
	2.5 D-4D	08.01-10.06	65-75				F 026 A07 099		
	3.0 D	07.01→	66				F 026 A07 099		
	4.6 D	10.00-06.02	96				F 026 A01 899		
		10.01-12.03	108				F 026 A01 899		
		01.04-02.08	108				F 026 A06 899		
	3.0 D	07.01→	66		TW		F 026 A02 515		
	4.6 D	10.00-06.02	96	Fg.-Nr. XZU302/342/307	KZG		F 026 A02 591		
		10.01-02.08	108				F 026 A06 716		
Dyna 100									
	2.5 D	08.87-05.95	55		SBR		F 026 A01 702		
		05.95-08.01	55						F 026 A03 418 ⁶
	2.5 D	05.95-08.01	55				F 01G 09B 11T		
	2.5 D	05.95-08.01	55				F 026 A01 889		
	2.5 D	05.95-08.01	55				F 026 A02 515		
Dyna 100 [Y2]									
	3.0 D-4D	09.06→	80				F 026 A07 099		
	3.0 D-4D	05.09→	80				F 026 A06 042		
Dyna [150]									
	4-093 3.0 D	11.99-10.01	67				F 026 A05 889		
	4-093 3.0 D	11.99-10.01	67				F 01G 09B 11T		
Dyna 150									
	2.8 D	10.96-07.01	58				F 01G 09B 11T		
	3.0 D	05.98-08.01	65				F 01G 09B 11T		



















		S							
	2.8D	05.95-07.01	58				F 026 A01 889		
	3.0D	05.98-08.01	65				F 026 A01 889		
Dyna 150 [Y2]									
	3.0D-4D	09.06→	80				F 026 A07 099		
	3.0D-4D	05.09→	80				F 026 A06 042		
Echo									
	1.5i 16V	09.99→	78/80			LLE	F 01G 09C 1E2		
	1.5i 16V	09.99→	78/80			RLE	F 01G 061 026		
	1.5i 16V	09.99→	78/80				F 026 A01 931		
	1.5i 16V	09.99→	78/80				F 026 A02 402		
Estima									
	2.4i	01.06→	125				0 204 023 212		
	2.4i	01.06→	125				0 204 023 347		
Estima Emina									
	2.4i 2.4i 4WD	01.92-12.99	99				F 026 A07 700		
Estima Lucida									
	2.4i	01.92-12.99	99				F 026 A07 700		
Fortuner									
	2.7i 4WD	06.04→	118			AG,LLE	0 986 AB8 517	20,64	
						AG,RLE	F 026 A06 711		
						GS,RLE	F 026 A05 907		
	3.0D Turbo 4WD	11.04→	120				F 026 A05 907		
	4.0i 4WD	05.06→	175			TW	0 986 AB8 517	20,64	
	2.7i 4WD	06.04→	118				F 026 A06 905		
	3.0D Turbo 4WD	11.04→	120				F 026 A06 905		
	4.0i 4WD	05.06→	175				F 026 A06 907		

















































◀ TOYOTA Fortuner								
	3.0 D Turbo 4WD	11.04→	120				F 026 A06 029	
	4.0 i 4WD	05.06→	175				F 026 A06 942	
Funcargo								
	1.3 i	08.99-09.05	64-65				F 01G 062 00J	
	1.3 i	08.99-09.05	64-65				F 01G 061 026	
Hiace								
	2.2 Super 16 & 12 Commuter	01.94-12.07	75				F 026 A07 978 ⁶	
	2.5 D Turbo	08.01→	75				F 01G 062 01P	F 01G 062 047 ⁷
	2.5 D Turbo	ABO 08.01→	75				F 01G 061 0NH	
		ABS 08.01→	75				F 01G 061 0NP	
	2.5 D Turbo	08.01→	75				F 026 A06 898	
	2.5 D Turbo	08.01→	75				F 026 A06 936	
Hiace [H2]								
	2.7	01.05→	111				F 01G 062 01P	F 01G 062 047 ⁷
	2.7	01.05→	111		TW		F 01G 061 0NK	
							F 01G 061 0NS	
	2.7	01.05→	111				F 026 A06 898	
	2.7	01.05→	111				F 026 A09 427	
Hiace [KLH]								
	2.5 D Turbo 4x4	ABO 08.01→	65		AG		F 026 A03 420	
					GS,LLE		F 026 A03 420	
					GS,RLE		F 026 A03 420	
		ABS 08.01→	65		AG		F 026 A03 419	
					GS,LLE		F 026 A03 419	
					GS,RLE		F 026 A03 419	
	2.5 D-4D	ABO 08.01→	70-86		AG		F 026 A03 420	
					GS,LLE		F 026 A03 420	
					GS,RLE		F 026 A03 420	
		ABS 08.01→	70-86		AG		F 026 A03 419	
					GS,LLE		F 026 A03 419	
					GS,RLE		F 026 A03 419	
	2.5 D-4D 4x4	ABO 08.01→	70-86				F 026 A03 420	
		ABS 08.01→	70-86				F 026 A03 419	



		S							
	2.5 D Turbo 4x4, D-4D, D-4D 4x4	08.01→	65/70-86				F 026 A07 097		
	2.5 D Turbo 4x4, D-4D, D-4D 4x4	09.06→	65/70-86				F 026 A06 042		
Hiace [LXH]									
									
	2.4 D	ABO 08.95-08.01	62			AG,LLE	F 026 A03 420		
						GS,LLE	F 026 A03 420		
						RLE	F 026 A03 420		
		ABS 08.95-08.01	62			AG,LLE	F 026 A03 419		
						GS,LLE	F 026 A03 419		
						RLE	F 026 A03 419		
	2.4 D Turbo	ABO 08.95-08.01	66			AG,LLE	F 026 A03 420		
						GS,LLE	F 026 A03 420		
						RLE	F 026 A03 420		
		ABS 08.95-08.01	66			AG,LLE	F 026 A03 419		
						GS,LLE	F 026 A03 419		
						RLE	F 026 A03 419		
	2.4 D Turbo 4WD	ABO 08.96-08.01	66				F 026 A03 420		
		ABS 08.96-08.01	66				F 026 A03 419		
	2.4 D, D Turbo, D Turbo 4WD	08.95-08.01	62/66				F 026 A07 097		
	2.4 D	08.95-08.01	62				F 026 A02 551		
Hiace [RCH]									
									
	2.4	ABO 03.97-11.08	85			AG	F 026 A03 420		
						GS,LLE	F 026 A03 420		
						GS,RLE	F 026 A03 420		
						TW	F 026 A03 419		
		ABS 03.97-11.08	85				F 026 A03 420		
						AG	F 026 A03 419		
						GS,LLE	F 026 A03 419		
						GS,RLE	F 026 A03 419		
	2.4 i	ABO 08.95-11.08	85			AG	F 026 A03 420		
						GS,LLE	F 026 A03 420		
						GS,RLE	F 026 A03 420		
						TW	F 026 A03 419		
		08.96-04.98	85			AG,LLE	F 026 A03 420		
						RLE	F 026 A03 420		
		ABS 08.95-11.08	85				F 026 A03 420		
						AG	F 026 A03 419		
						GS,LLE	F 026 A03 419		
						GS,RLE	F 026 A03 419		
		08.96-04.98	85			AG,LLE	F 026 A03 419		
						RLE	F 026 A03 419		
	2.4 i 4WD	ABO 08.96-04.98	85			AG,LLE	F 026 A03 420		
						GS,LLE	F 026 A03 420		
						RLE	F 026 A03 420		
		ABS 08.96-04.98	85			AG,LLE	F 026 A03 419		
						GS,LLE	F 026 A03 419		
						RLE	F 026 A03 419		
	2.7	ABO 04.98-05.09	105			AG	F 026 A03 420		
						GS,LLE	F 026 A03 420		

























		S									
 ◀ TOYOTA Hiace [RCH]											
2.7		ABO	04.98-05.09	105					GS,RLE	F 026 A03 420	
									TW	F 026 A03 419	
2.7 4x4		ABO	04.98-05.09	105					ABS	F 026 A03 420	
									AG	F 026 A03 419	
									GS,LLE	F 026 A03 419	
									GS,RLE	F 026 A03 419	
									AG	F 026 A03 420	
									GS,LLE	F 026 A03 420	
									GS,RLE	F 026 A03 420	
									TW	F 026 A03 419	
2.7 4x4		ABS	04.98-05.09	105					AG	F 026 A03 420	
									GS,LLE	F 026 A03 419	
									GS,RLE	F 026 A03 419	
									TW	F 026 A03 419	
									AG	F 026 A03 419	
									GS,LLE	F 026 A03 419	
									GS,RLE	F 026 A03 419	
									GS,RLE	F 026 A03 419	
	2.4, i, i4WD		08.95-11.08	85					F 026 A07 097		
	2.7, 4x4		04.98-05.09	105					F 026 A07 097		
	2.4, i, i4WD		08.95-11.08	85					F 026 A07 098		
	2.7, 4x4		04.98-05.09	105					F 026 A07 098		
Hiace Van [LH]											
											
	2.4D, D 4x4		09.93-01.05	62					RLE	F 026 A01 649	
	2.8D		09.93-08.00	58					RLE	F 026 A01 649	
	2.4D	ABS	09.98-01.05	62					LLE	F 01G 09B 1FN	
	2.8D	ABS	09.98-08.00	58					LLE	F 01G 09B 1FN	
	2.4D, D 4x4		08.89-01.05	62						F 026 A01 855	
	2.8D		08.89-08.00	58						F 026 A01 855	
	2.4D, D 4x4		08.89-01.05	62						F 026 A02 551	
	2.8D		08.89-08.00	58						F 026 A02 551	
Hiace Van [LXH]											
											
	2.4D Turbo	ABO	08.96-08.01	66						F 026 A03 420	
		ABS	08.96-08.01	66						F 026 A03 419	
	2.4D Turbo		08.96-08.01	66						F 026 A07 097	
Hiace Van [ZH]											
											
	2.0	ABS	09.98-09.02	74						F 01G 09B 1FN	
	2.4, i	ABS	09.98-02.06	84/88						F 01G 09B 1FN	
	2.0		09.93-08.02	74						F 026 A01 855	
	2.4, i, i4WD		09.93-08.02	84/88						F 026 A01 855	
Hiace Wagon [LH]											
											
	2.4D		08.89-02.06	62						F 026 A07 980 ⁶	
			09.93-02.06	62						TBR,TW	F 026 A03 417 ⁶
			09.93-08.00	58						RLE	F 026 A01 649
	2.8D		09.93-08.00	58					RLE	F 026 A01 649	

		S							
	3.0D			08.98-02.06	65				F 026 A03 417 ⁶
						RLE	F 026 A01 649		
				08.01-02.06	75				F 026 A03 417 ⁶
		ABO		08.01-02.06	75	RLE	F 026 A01 649		
	2.4D	ABS		09.98-02.06	62	LLE	F 01G 09B 1FN		
	2.8D	ABS		09.98-08.00	58	LLE	F 01G 09B 1FN		
	3.0D	ABS		09.98-02.06	65/75	LLE	F 01G 09B 1FN		
	2.4D			08.89-02.06	62		F 026 A01 855		
	2.8D			08.89-08.00	58		F 026 A01 855		
	3.0D			08.98-02.06	65/75		F 026 A01 855		
	2.4D			08.89-02.06	62		F 026 A02 551		
	2.8D			08.89-08.00	58		F 026 A02 551		
	3.0D			08.98-02.06	65/75		F 026 A02 551		
Hiace Wagon [ZH]									
									
	2.4 i	ABS		09.98-09.02	88		F 01G 09B 1FN		
	2.4 i			09.93-08.02	88		F 026 A01 855		
Hilux									
									
	1.8			11.86-08.98	59		F 026 A07 538		F 026 A08 434 ⁶
	2.0			11.00-12.02	68		F 026 A01 711		F 026 A03 421 ⁶
		ABO		10.98-12.02	68		F 026 A01 711		F 026 A03 421 ⁶
		ABS		10.98-12.02	68	RLE	F 026 A01 710		
	2.2 4x4			02.86-08.98	70		F 026 A07 538		F 026 A08 434 ⁶
	2.4D			10.84-03.98	55		F 026 A07 538		F 026 A08 434 ⁶
	2.4D Turbo			05.95-12.00	64	RLE	F 026 A01 714		F 026 A03 419
	2.4 TD	ABO		10.98-12.02	61		F 026 A06 923		F 026 A03 419 ⁶
	2.5 16V D Turbo			03.05-12.11	75		0 204 032 618		
	3.0 TD, 16V D Turbo Interc.			01.02-12.11	85/120		0 204 032 618		
	2.0			10.98-12.02	68		F 026 A07 613		
	2.4D Turbo			05.95-12.00	64		F 026 A07 613		
	2.5 4x4			08.08-07.11	106		F 026 A06 905		
	2.4D Turbo			05.95-12.00	64		F 026 A02 515		
	2.5 4x4			08.08-07.11	106		F 026 A06 029		
Hilux [Africa]									
									
	3.0D 4x4	ABS		10.98→	67		F 026 A05 908		
Hilux [N5/N6]									
									
	1.6			08.86-07.98	50	4SB	F 026 A01 554		
	2.2			08.86-07.98	75	4SB	F 026 A01 554		
	2.4, D			08.84-07.98	62/80	4SB	F 026 A01 554		
	2.8D			08.95-07.98	58	4SB	F 026 A01 554		



		S							
◀ TOYOTA Hilux [N5/N6]									
	2.4	01.86-07.98	80				F 026	A01 818	
	1.6	08.86-07.98	50				F 026	A07 689	
	2.2	08.86-07.98	75				F 026	A07 689	
	2.4	01.86-07.94	80				F 026	A07 689	
		08.94-07.98	80				F 026	A02 570	
	2.4D	08.84-07.98	62				F 026	A07 689	
	2.8D	08.95-07.98	58				F 026	A07 689	
Hilux [N14/N15]									
	2.7	08.97-03.06	108				F 026	A01 919	
Hilux [N15]									
	2.5 D-4D	07.05-08.11	75/88-106			GS,RLE, TW	F 026	A05 907	
	2.5 D-4D	07.05-07.08	75				F 026	A06 905	
		07.05→	88-106				F 026	A06 905	
	2.5 D-4D	07.05-08.11	75/88-106			TW	F 026	A06 029	
Hilux [N25]									
	2.5 D-4D 4x4	07.05-08.11	88-106			RLE,TW	F 026	A05 907	
		07.11→	75			TW	F 026	A05 907	
			106			TW	F 026	A05 907	
	2.5 D-4D 4x4	07.05-09.08	88-106				F 026	A06 905	
	2.5 D-4D 4x4	07.05-04.14	75/88-106				F 026	A06 029	
Hilux [N26]									
	3.0 D Turbo 4x4	03.05→	120			AG,LLE,TW	0 986	AB8 517	20,64
						AG,RLE,TW	F 026	A06 711	
						GS,RLE,TW	F 026	A05 907	
	3.0 D-4D 4x4	10.06-08.11	120-126			AG,LLE,TW	0 986	AB8 517	20,64
						AG,RLE,TW	F 026	A06 711	
						GS,RLE,TW	F 026	A05 907	
		07.11→	120			TW	0 986	AB8 517	20,64
			126			TW	0 986	AB8 517	20,64
	3.0 D Turbo 4x4	03.05→	120				F 026	A06 905	
	3.0 D-4D 4x4	10.06-09.08	120-126				F 026	A06 905	
	3.0 D Turbo 4x4	03.05→	120				F 026	A06 029	
	3.0 D-4D 4x4	10.06-04.14	120-126				F 026	A06 029	
		07.11-04.14	120				F 026	A06 029	



		S							
Hilux [N35]									
									
	2.5 D-4D	07.11-04.14	75/106				F 026 A06 029		
Hilux Pickup									
									
	1.8 SWB	10.98-12.02	65				F 026 A01 711		F 026 A03 421 ⁶
Hilux Pickup [N8...13]									
									
	1.8	09.92-08.94	57				F 026 A01 646		
	2.4 D	09.92-08.97	62		RLE		F 026 A01 671		
	2.4 D 4x4	09.92-08.97	62		RLE		F 026 A01 645		
		01.94-12.97	58		TW		F 026 A01 672		F 026 A03 418 ⁶
	1.8	11.91-08.94	57				F 026 A02 570		
	2.2 4WD	11.91-08.94	69				F 026 A02 570		
	2.4 D, D 4x4, i 4WD, i 4x4	11.91-08.97	62/84				F 026 A02 570		
	2.4 D 4x4	01.94-12.97	58				F 026 A02 515		
Hilux Pickup [N14...19]									
									
	2.4 D	ABO 08.97-08.01	62		RLE		F 026 A06 923		
	2.5 D Turbo 4x4	ABO 08.01-08.05	65/75	Fg.-Nr. *KDN145*, Fg.-Nr. *KDN150*	RLE		F 026 A06 923		
				Fg.-Nr. KDN145, Fg.-Nr. KDN150					F 026 A03 419 ⁶
				Fg.-Nr. KDN165, Fg.-Nr. KDN170					F 026 A03 421 ⁶
		ABS 08.01-08.05	65/75	Fg.-Nr. KDN145, Fg.-Nr. KDN150					F 026 A03 420 ⁶
	2.4 D	08.97-08.01	62		LLE		F 026 A01 919		
					RLE		F 026 A07 613		
		11.97-08.01	62				F 026 A01 919		
	2.4 i, i 4WD	08.97-08.01	79/104				F 026 A07 613		
	2.5 D Turbo 4x4	08.01-08.05	65/75		TW		0 986 AB8 823	19,05	
							0 986 AB8 824	20,64	
	2.4 D	08.97-08.01	62				F 026 A02 515		
	2.5 D Turbo 4x4	08.01-08.05	65/75	Fg.-Nr. *KDN145*→, *KDN150*→ Fg.-Nr. *KDN165*→, *KDN170*→			0 986 AB8 823	19,05	
							0 986 AB8 824	20,64	
Hilux [Raider]									
									
	2.7 i VVTi 4x4	06.05→	119				F 026 A06 905		
Hilux Vigo									
									
	2.5 D Turbo	07.02→	75-76		AG		F 026 A06 711		
	2.5 D Turbo 4x4				GS		F 026 A05 907		





◀ TOYOTA

Hilux Wagon [N8...13]



	2.4 D Turbo	09.94-11.95	69		F 026 A01 672	
	3.0 D	09.92-11.95	92/105	RLE	F 026 A01 645	
	3.0 i	09.94-11.95	92/105	LLE	F 026 A01 672	

	3.0 D	08.89-11.95	92/105	RLE	F 026 A07 603	
	3.0 i					

	3.0 D	08.93-11.95	92		F 026 A06 936	
	3.0 i	08.89-11.95	105		F 026 A02 560	

Innova



	2.0 i	02.09→	100	AG	F 026 A06 711	
				GS,RLE	F 026 A05 907	

Land Cruiser



	4.2 D	12.91-03.00	96		F 026 A01 606	
--	-------	-------------	----	--	----------------------	--

Land Cruiser [J7]



	2.4 D Turbo	01.90-01.95	63	LLE	F 026 A01 602	
			69	SBR	F 026 A01 602	
	2.4 i	01.90-04.96	81	LLE	F 026 A01 602	
			84	SBR	F 026 A01 602	
	3.4 D	01.90-02.94	66		F 026 A01 602	
	4.2 D	01.90-08.99	96-99		F 026 A01 602	
	4.2 D, D 4x4	08.99→	96		F 026 A05 898	F 026 A03 421⁶
	4.5 4x4	03.07→	151		F 026 A05 898	F 026 A03 421⁶

	4.2 D	01.90-08.01	96-99		F 026 A07 580	
--	-------	-------------	-------	--	----------------------	--

	3.0 D Turbo	05.93-04.96	92		F 026 A06 936	
	3.4 D	11.84-02.94	66		F 026 A02 523	
	4.2 D	01.90-08.01	96-99		F 026 A02 550	
	4.5	01.07→	165		F 026 A02 549	

Land Cruiser [J7/10]



















	4.2 D 4x4	03.99-02.07	96		F 026 A05 898	F 026 A03 421⁶
		ABO 03.99-02.07	96			F 026 A03 421⁶

	4.2 D 4x4	03.98-10.07	96		F 026 A05 953	
--	-----------	-------------	----	--	----------------------	--

	4.2 D 4x4	03.98-10.07	96		F 026 A06 044	
--	-----------	-------------	----	--	----------------------	--



		S							
Land Cruiser [J8]									
									
	4.2 D	ABO	01.90-01.98	99					F 026 A03 419 ⁶
			08.92-01.95	99	LLE		F 026 A01 638		
	4.2 D Turbo	ABO	01.90-01.95	118-125					F 026 A03 419 ⁶
			09.92-12.94	118-125			F 026 A01 638		
			01.95-01.95	118-125			F 026 A07 591		
		ABS	08.92-12.94	118-125	RLE		F 026 A01 844		
			01.95-01.95	118-125	RLE		F 026 A01 669		
	4.2 24V D Turbo	ABO	01.95-01.98	125					F 026 A03 419 ⁶
		ABS	01.95-01.98	125					F 026 A03 420 ⁶
					RLE		F 026 A01 669		
	4.5 i 24V	ABO	08.92-01.95	151-158	LLE		F 026 A01 638		
			08.92-01.98	151-158					F 026 A03 419 ⁶
			01.95-01.98	151-158	RLE		F 026 A07 591		
		ABS	01.95-01.98	151-158					F 026 A03 420 ⁶
	4.2 D, D Turbo, 24V D Turbo		01.90-01.98	99/118-125	LLE		F 026 A01 867		
	4.5 i 24V		01.95-01.98	151-158			F 026 A01 888		
	4.2 D		01.92-12.94	99			F 026 A09 632		
			01.95-01.98	99			F 026 A02 539		
	4.2 D Turbo		01.92-12.94	118-125			F 026 A09 632		
	4.2 24V D Turbo		01.95-01.98	125			F 026 A02 539		
	4.5 i 24V		08.92-08.96	151-158			F 026 A02 539		
Land Cruiser [J9]									
									
	2.7 i 16V	ABO	10.96-12.06	97-112					F 026 A03 419 ⁶
					LLE				F 026 A03 419 ⁶
					RLE		F 026 A01 714		
		ABS	10.96-12.06	97-112					F 026 A03 420 ⁶
					RLE		F 026 A01 710		
	2.8 D		04.96-09.02	58	RLE		F 026 A01 714		
	3.0 D Turbo		04.96-08.00	88	LLE				F 026 A03 419 ⁶
					RLE		F 026 A01 714		
			10.99-08.00	88		Fg.-Nr. *ZJ95*→	F 026 A01 710		
		ABO	04.96-12.06	88-92					F 026 A03 421 ⁶
		ABS	04.96-10.99	88		Fg.-Nr. *ZJ95*→	RLE	F 026 A01 710	
	3.0 D Turbo Interc.		04.96-09.02	92	LLE				F 026 A03 419 ⁶
					RLE		F 026 A01 714		
			10.99-09.02	92		Fg.-Nr. *ZJ95*→	F 026 A01 710		
		ABS	04.96-10.99	92		Fg.-Nr. *ZJ95*→	RLE	F 026 A01 710	
	3.4 i 24V	ABO	04.96-12.06	131-136	LLE				F 026 A03 419 ⁶
					RLE		F 026 A01 714		
		ABS	04.96-12.06	131-136	RLE		F 026 A01 710		
	2.7 i 16V	ABO	10.96-12.06	97-112	LLE		F 01G 09B 1FU		
		ABS	10.96-12.06	97-112	LLE		F 01G 09B 1FS		
	3.4 i 24V	ABO	04.96-12.06	131-136	LLE		F 01G 09B 1FU		
		ABS	04.96-12.06	131-136	LLE		F 01G 09B 1FS		
	2.7 i 16V		10.96-07.00	97-112	LLE		F 026 A01 919		
			10.96-12.06	97-112	RLE		F 026 A01 896		
	2.8 D		04.96-08.00	58			F 026 A01 919		
	3.0 D Turbo		04.96-12.06	88-92			F 026 A01 919		
			08.00-09.02	120			F 026 A01 919		
	3.0 D Turbo Interc.		04.96-08.00	92			F 026 A01 919		
	3.4 i 24V		04.96-12.06	131-136			F 026 A01 897		





◀ TOYOTA Land Cruiser [J9]

	2.8 D	04.96-09.00	58			F 026 A02 515	
	3.0 D Turbo, D Turbo Interc.	04.96-12.06	88-92/120			F 026 A06 042	
	3.4 i 24V	04.96-12.06	131-136			F 026 A02 589	

Land Cruiser [J10]

	4.2 D Turbo 4x4	ABO	01.98-07.08	122-150		F 026 A06 501	
	4.7 i 32V 4x4	ABO	01.98-07.08	173		F 026 A06 501	F 026 A06 602⁶
	4.5		03.98→	165		F 026 A05 954	
	4.7 i 32V 4x4		01.98-07.08	173		F 026 A05 953	
	4.7 i 32V 4x4		01.98-07.08	173		F 026 A06 046	

Land Cruiser Prado [J9]

	2.7 i 16V 4x4	ABO	10.96-09.04	112	LLE		F 026 A03 419⁶
		ABS	10.96-09.04	112	RLE	F 026 A01 714	
	3.4 i 24V	ABO	04.96-09.03	131-136	RLE	F 026 A01 710	F 026 A03 421⁶
	3.4 4x4	ABO	08.96-09.02	142			F 026 A03 419⁶
	2.7 i 16V 4x4	ABO	10.96-09.04	112		F 01G 09B 1FU	
		ABS	10.96-09.04	112		F 01G 09B 1FS	
	3.4 i 24V		04.96-09.03	131-136	LLE	F 01G 09B 1FS	
	3.4 4x4		08.96-09.02	142		F 01G 09B 1FU	
	2.7 i 16V 4x4		10.96-07.00	112	LLE	F 026 A01 919	
			10.96-09.04	112	RLE	F 026 A01 896	
	3.4 i 24V, 4x4		04.96-09.03	131-136/142		F 026 A01 897	
	3.4 i 24V		04.96-09.03	131-136/		F 026 A02 589	
	3.4 4x4			142			

Land Cruiser [105]

	4.5 i 24V		01.98→	165			F 026 A06 602⁶
--	-----------	--	--------	-----	--	--	----------------------------------

Limo

	1.5 i		05.04→	80		F 026 A02 402	
--	-------	--	--------	----	--	----------------------	--

MR2 Cabrio [W3]

	1.8 16V		12.99-11.03	103	AG,RLE	F 01G 09C 1DC	
					GS,RLE	F 01G 09C 1DB	
	1.8 16V		12.99-11.03	103	RLE	F 01G 09B 1R1	





	1.8 16V	12.99-04.00	103			F 026 A07 633	
--	---------	-------------	-----	--	--	----------------------	--

Picnic



	2.0i 16V	09.96-05.01	98		LLE	F 01G 09B 1AB	
--	----------	-------------	----	--	-----	----------------------	--

	2.0i 16V	09.96-05.01	98			F 026 A06 205	
	2.2D Turbo	09.97-05.01	66			F 026 A06 205	

Previa



	2.0D Turbo	02.01-04.03	85		RLE	F 026 A05 893	
		05.03-01.06	85				F 01G 09C 17B ⁶

					LLE	F 01G 09C 1CA	
					RLE	F 01G 09C 1C9	

	2.4i 16V	02.00-03.03	118		RLE	F 026 A05 893	
--	----------	-------------	-----	--	-----	----------------------	--

		ABO 09.96-12.00	97			F 026 A05 886	
--	--	-----------------	----	--	--	----------------------	--

		MFD 04.03→	118		LLE	F 01G 09C 1CA	
					RLE	F 01G 09C 1C9	

		OFD 04.03→	118		LLE	F 01G 09C 12D	
					RLE	F 01G 09C 12C	

	2.4i 16V 4x4	02.00-04.03	118		RLE	F 026 A05 893	
--	--------------	-------------	-----	--	-----	----------------------	--

		05.03-01.06	118				F 01G 09C 17B ⁶
--	--	-------------	-----	--	--	--	-----------------------------------

					LLE	F 01G 09C 1CA	
						F 01G 09C 12D	

					RLE	F 01G 09C 1C9	
						F 01G 09C 12C	

	2.0D Turbo	MFD 05.03-01.06	85		LLE	F 01G 09B 1V7	
					RLE	F 01G 09B 1V6	

		OFD 05.03-01.06	85		LLE	F 01G 09B 1X6	
					RLE	F 01G 09B 1X5	

	2.4i 16V	OFD 04.03→	118		RLE	F 01G 09B 1X1	
--	----------	------------	-----	--	-----	----------------------	--

	2.4i 16V	02.00-03.03	118		LLE	F 01G 09B 1UY	
--	----------	-------------	-----	--	-----	----------------------	--

	2.4i 16V 4x4				RLE	F 01G 09B 1UX	
--	--------------	--	--	--	-----	----------------------	--

		04.03→	118		LLE,TW	F 01G 09B 1V5	
						F 01G 09B 1X3	
						F 01G 09B 1X4	

		MFD 04.03→	118		AG,RLE	F 01G 09B 1V2	
					GS,RLE	F 01G 09B 1V3	

	2.4i 16V 4x4	OFD 04.03-01.06	118		AG,RLE	F 01G 09B 1X1	
					GS,RLE	F 01G 09B 1X2	

	2.4i 16V	05.90-12.00	97/99-103			F 026 A01 890	
	2.4i 16V 4x4						

	2.0D Turbo	02.01-01.06	85			0 986 486 519	20,6
--	------------	-------------	----	--	--	----------------------	------

	2.4i 16V	05.90-12.00	97/99-103			F 026 A07 700	
--	----------	-------------	-----------	--	--	----------------------	--

	2.4i 16V 4x4	02.00→	118			F 026 A06 041	
--	--------------	--------	-----	--	--	----------------------	--

Previda



























	2.4	09.14→	125		LLE	0 204 772 538	
					RLE	0 204 772 535	

		MFD 01.06-08.14	125		LLE	0 204 023 218	
					RLE	0 204 023 216	



		S							
TOYOTA Previda									
	2.4	OFD	01.06-08.14	125			LLE		0 204 023 214
							RLE		0 204 023 212
	2.4		01.06→	125					0 265 005 651
	2.4		01.06→	125			TW		F 01G 065 00X
Probox Van									
	1.3 i		06.02-09.14	64					F 026 A01 931
	1.5 i		06.02-09.14	80					F 026 A01 931
	1.3 i		06.02-09.14	64					F 026 A02 402
	1.5 i		06.02-09.14	80					F 026 A02 402
Quantum									
	2.5 D-4D		03.05→	75					F 01G 062 01N
									F 01G 062 047⁷
	2.5 D-4D		03.05→	75			TW		F 01G 061 0NG
	2.5 D-4D		03.05→	75					F 026 A06 898
	2.5 D-4D		03.05→	75					F 026 A06 936
Ractis									
	1.5 i		09.05-11.10	81			TW		0 204 023 203
									0 204 023 205
	1.5 i		09.05-11.10	81			TW		0 204 023 183
									0 204 023 184
RAV4									
	2.0 i 4WD		04.94-05.00	99					F 026 A01 670
	2.0 i 4WD		04.94-05.00	99					F 026 A07 585
RAV4 [A1]									
	2.0 i 16V 4x4		04.94-08.00	94/96/99			RLE		F 026 A01 670
	2.0 i 16V 4x4		04.94-08.00	96					F 026 A07 585
				99					F 026 A07 585



















		S							
	2.0i 16V 4x4	04.95-08.00	94				F 026 A07 585		
		08.96-08.00	99			RLE	F 026 A07 585		
		09.96-08.00	96			RLE	F 026 A07 585		
	2.0i 16V 4x4	04.94-08.96	94/96/99				F 026 A06 205		
RAV4 [A2]									
									
	1.8i 16V	05.00-07.03	103			LLE	F 01G 09B 1VD		
	2.0 VVT-i 4x4	05.00-07.03	110			LLE	F 01G 09B 1VD		
	1.8i 16V	05.00-11.05	103				F 026 A05 959		
	2.0 VVT-i 4x4	05.00-11.05	110				F 026 A05 959		
	2.4i 4x4	07.03-01.06	120				F 026 A05 959		
	1.8i 16V	05.00-11.05	103				F 026 A07 633		
	2.0D Turbo	05.01-11.05	85				0 986 486 519	20,6	
	2.0 VVT-i 4x4	05.00-11.05	110				F 026 A06 043		
	2.4i 4x4	07.03-01.06	120				F 026 A06 043		
RAV4 [A3]									
									
	2.0 4x4	11.05-09.06	112			LLE	F 026 A05 958		
	2.4 4x4	11.05-09.06	125			LLE	F 026 A05 958		
	2.0 4x4	11.05-11.12	112				F 026 A06 043		
	2.2 D-CAT 4x4, D-4D, D-4D 4x4	11.05-11.12	100-110/130				0 986 486 519	20,6	
RAV4 Cabrio [A1]									
									
	2.0i 16V 4x4	12.97-08.00	94			RLE	F 026 A01 670		
	2.0i 16V 4x4	11.95-08.00	94/96				F 026 A07 585		
Starlet [P8]									
									
	1.0	ABO 12.89-05.94	40			JBH	0 986 480 655	19	
	1.3i 12V, 12V	ABO 12.89-05.94	53/55-60			JBH	0 986 480 655	19	
	1.5 D	ABO 12.89-05.94	40			JBH	0 986 480 655	19	
Starlet [P9]									
									
	1.3i 16V	ABO 01.96-12.97	55/60-62						F 026 A03 412⁵
		ABS 01.96-12.97	55/60-62						F 026 A03 413⁵
	1.3 12V	ABO 01.96-07.99	53			LLE	F 01G 09B 0X7		
						RLE	F 01G 09B 0X8		
	1.3i 16V	01.96-07.99	53/55/			LLE	F 026 A09 618		
	1.3 12V		60-62			RLE	F 026 A01 853		



		S							
◀ TOYOTA Starlet [P9]									
	1.3 i 16V 1.3 12V		01.96-07.99	53/55/ 60-62				0986 486 569	22,2
Succeed Van									
	1.5 i		06.02-09.14	80				F 026 A01 931	
	1.5 i		06.02-09.14	80				F 026 A02 402	
Tarago									
	2.4 i 16V	ABO	08.91-12.00	97		GS		F 026 A01 644	
			09.91-12.00	97					F 026 A03 417⁶
			08.96-12.00	97		AG		F 026 A05 886	
	2.4 i 16V		05.90-12.00	97				F 026 A01 890	
	2.4 i 16V		05.90-12.00	97				F 026 A07 700	
Urban Cruiser [P1]									
	1.3 WT-i		01.09→	74		RLE		F 026 A05 958	
	1.4 D-4D 4x4		01.09→	66		RLE		F 026 A05 958	
Verso-S									
	1.3 WT-i		11.10→	73		RLE		F 026 A05 958	
Vitz									
	1.0 i		01.05-12.10	52				0 204 023 203	
	1.3 i		01.05-12.10	64				0 204 023 203	
	1.0 i		01.05-12.10	52		TW		0 204 023 834	
								0 204 023 835	
	1.3 i		01.05-12.10	64				0 204 023 834	
	1.3 i		09.99-02.05	64-65				F 026 A01 931	
	1.3 i		09.99-02.05	64-65				F 026 A02 402	
	1.5 i		12.10→	80				F 026 A06 571	
Yaris [P1]									
	1.0 i 16V		01.01-08.05	50		RLE		0 204 123 549	20,64
		ABO	01.99-12.02	50		LLE		F 01G 09C 0EJ	
			01.01-08.05	50		LLE		0 204 123 560	20,64



		S								
1.0i 16V	ABS	01.99-12.02	50			LLE	F 01G 09C 1E2			
		01.01-08.05	50			JBH,LLE	0 986 481 023	20,64		
1.3i 16V		05.02-08.05	63			RLE	0 204 123 549	20,64		
	ABO	08.99-12.02	66			LLE	F 01G 09C 0EJ			
		05.02-08.05	63			LLE	0 204 123 560	20,64		
	ABS	08.99-12.02	66			LLE	F 01G 09C 1E2			
05.02-08.05		63			JBH,LLE	0 986 481 023	20,64			
1.4D Turbo		02.03-08.06	55			JBH,LLE	0 986 481 023	20,64		
						RLE	0 204 123 549	20,64		
	ABO	10.01-08.05	55			LLE	F 01G 09C 0EJ			
	ABS	10.01-09.03	55			LLE	F 01G 09C 1E2			
10.03-08.05		55			LLE	F 01G 062 00G				
1.5i 16V	ABO, MFD	01.01-11.03	78			LLE	F 01G 09C 1DD			
		12.03-08.05	78			LLE	F 01G 062 025			
	ABO, OFD	01.01-08.05	78			RLE	F 01G 09C 1E3			
	ABS, OFD	01.01-09.03	78			LLE	F 01G 09C 1E2			
		10.03-08.05	78			LLE	F 01G 062 00G			
	1.0i 16V	01.01-08.05	50			LLE,SSJ,STB	0 204 125 754			
						RLE,SSJ,STB	0 204 125 753			
			07.03-08.05	50		SSJ	0 204 125 818			
	1.3i 16V		05.02-08.05	63			LLE,STB	0 204 125 754		
							RLE,STB	0 204 125 753		
	1.4D Turbo		10.01-08.05	55			LLE	F 01G 061 029		
			02.03-08.06	55			LLE,STB	0 204 125 754		
	1.5i 16V		01.01-12.02	78			RLE	F 01G 061 026		
		MFD	01.01-08.05	78			LLE	F 01G 061 05H		
		1.3i 16V		08.99-12.02	66			F 026 A01 931		
1.4D Turbo			10.01-08.05	55			F 026 A01 931			
1.5i 16V		OFD	01.01-08.05	78			F 026 A01 931			
	1.3i 16V		08.99-12.02	66			F 026 A02 402			
	1.5i 16V		01.01-08.05	78			F 026 A02 402			
	1.0i 16V		01.01-04.02	50			0 265 216 853^B			
			05.02-03.05	50			0 265 216 905^B			
			04.05-08.05	50			0 265 218 662^B			
	1.3i 16V		05.02-03.05	63			0 265 216 905^B			
			04.05-08.05	63			0 265 218 662^B			
	1.4D Turbo		02.03-03.05	55			0 265 216 905^B			
			04.05-08.06	55			0 265 218 662^B			
	Yaris [P9]									
										
	1.3 VVT-i		01.06→	64			AG,RLE	0 204 023 203		
							GS,RLE	0 204 023 075		
1.5 VVT-i		01.06→	81				AG,RLE	0 204 023 203		
							GS,RLE	0 204 023 075		
	1.3 VVT-i		01.06→	64			RLE	0 204 023 834		
							TW	0 204 023 834		
1.5 VVT-i		01.06→	81				TW	0 204 023 834		
	1.3 VVT-i		01.06-10.10	64			RLE	F 026 A05 958		
		1.5 VVT-i		01.06-10.10	81			RLE	F 026 A05 958	
	1.5 VVT-i			01.06→	81				F 026 A06 571	





◀ TOYOTA

Yaris [P9, JTD]



	1.0 VVT-i	08.05-07.11	51	RLE,STB	0 204 023 075
				4SB,RLE	0 204 023 206
	1.8 VVT-i	11.06-07.11	97	RLE	0 204 023 600
	1.0 VVT-i	08.05-07.11	51	RLE,STB	0 204 023 210
		MFD 08.05-07.11	51	4SB,RLE	0 204 023 097
		OFD 08.05-07.11	51	4SB,RLE	0 204 023 096
	1.8 VVT-i	11.06-07.11	97	RLE	0 204 023 840
	1.8 VVT-i	11.06-07.11	97	RLE	F 026 A05 958

Yaris [P13, JTD]



	1.3	08.11→	73	RLE	F 026 A05 958
--	------------	--------	----	-----	----------------------

Yaris Verso [P2]



	1.3 i 16V	08.99-09.03	63	RLE	F 01G 09C 1E3
		10.03-09.05	63	RLE	F 01G 062 00J
		ABO 08.99-09.05	63	LLE	F 01G 09C 0EJ
		ABS 08.99-09.03	63	LLE	F 01G 09C 1E2
		10.03-09.05	63	LLE	F 01G 062 00G
	1.4 D Turbo	ABO 08.01-09.05	55	LLE	F 01G 09C 0EJ
		ABS 08.01-09.03	55	LLE	F 01G 09C 1E2
		10.03-09.05	55	LLE	F 01G 062 00G
	1.5 i 16V	ABO, 08.99-11.03	81	LLE	F 01G 09C 1DD
		MFD 12.03-09.05	81	LLE	F 01G 062 025
ABO, 08.99-12.02		81	LLE	F 01G 09C 0EJ	
OFD 08.99-09.03		81	RLE	F 01G 09C 1E3	
10.03-09.05		81	RLE	F 01G 062 00J	
ABS, 08.99-09.03		81	LLE	F 01G 09C 1E2	
OFD 10.03-09.05		81	LLE	F 01G 062 00G	
	1.3 i 16V	08.99-09.05	63	RLE	F 01G 061 026
		1.4 D Turbo	08.01-09.05	55	LLE
	1.5 i 16V	MFD 08.99-11.03	81	LLE	F 01G 09B 1ST
		OFD 08.99-09.03	81	LLE	F 01G 09B 1SH
		10.03-09.05	81	LLE	F 01G 061 05H
	1.3 i 16V	08.99-09.05	63		F 026 A01 931
	1.4 D Turbo	08.01-09.05	55		F 026 A01 931
	1.5 i 16V	OFD 08.99-09.05	81		F 026 A01 931
	1.3 i 16V	08.99-09.05	63		F 026 A02 402
	1.5 i 16V	08.99-09.05	81		F 026 A02 402

4-Runner [N18]



	2.7 i 16V	ABO 11.95-08.00	112		F 026 A03 419 ⁶
	3.0 D Turbo	ABO 11.95-08.00	92		F 026 A03 419 ⁶
	2.7 i 16V	11.95-08.00	112		F 026 A01 896
	3.0 D Turbo	04.96-08.00	92		F 026 A01 919

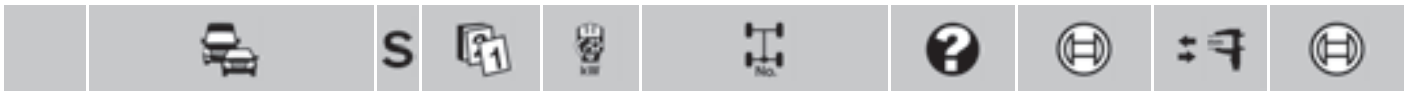

	3.4i	11.95-08.02	136		F 026 A01 896	
	3.0 D Turbo	11.95-08.00	92		F 026 A06 042	
	3.4i	11.95-08.02	136		F 026 A02 589	

UAZ

Hunter

	2.7 i 4x4	01.08→	94,1		0 265 005 146	
--	-----------	--------	------	--	----------------------	--

Patriot

	2.7 4x4	09.06→	105		0 265 005 146	
--	---------	--------	-----	--	----------------------	--

Pickup

	2.7 4x4	06.08→	105		0 265 005 146	
--	---------	--------	-----	--	----------------------	--

UMM (UNIAO METALO MECANICA)

Alter

	2.0	06.86-01.01	64		0 204 131 262	
	2.3 D	06.86-01.01	50		0 204 131 262	
	2.5 4x4	06.86-01.01	56		0 204 131 262	

VAUXHALL

Adam

	1.0	09.14→	85	LLE,STB	0 204 803 866	22,2
				RLE,STB	0 204 123 743	22,2
				4SB,LLE	0 204 822 479	
				4SB,RLE	0 204 123 744	23,81
	1.2	04.13→	51	LLE,STB	0 204 803 866	22,2
				RLE,STB	0 204 123 743	22,2
				4SB,LLE	0 204 822 479	
				4SB,RLE	0 204 123 744	23,81
	1.4	04.13→	64/74/110	LLE,STB	0 204 803 866	22,2
	1.4 Turbo			RLE,STB	0 204 123 743	22,2
				4SB,LLE	0 204 822 479	
				4SB,RLE	0 204 123 744	23,81
	1.0	09.14→	85	LLE,STB	0 204 125 870	
				4SB,LLE	0 204 125 869	
	1.2	04.13→	51	LLE,STB	0 204 125 870	
				4SB,LLE	0 204 125 869	
	1.4	04.13→	64/74/110	LLE,STB	0 204 125 870	
	1.4 Turbo			4SB,LLE	0 204 125 869	





◀ VAUXHALL Adam

	1.0	09.14→	85			0 986 486 588	31
	1.2	04.13→	51	Get.-Nr. F17	MG5	0 986 486 588	31
	1.4, Turbo	04.13→	64/74/110	Get.-Nr. F17	MG5	0 986 486 588	31

Agila [A]



	1.0 i	ABO 09.99-02.08	43/44			0 204 123 540	20,64
	1.0 Twinport	ABS 09.99-02.08	43/44			0 204 123 542	20,64
	1.2 i	ABO 09.00-02.08	55/59			0 204 123 540	20,64
	1.2 Twinport	ABS 09.00-02.08	55/59			0 204 123 542	20,64

	1.0 i, Twinport	09.99-02.08	43/44			0 204 125 742	
	1.2 i, Twinport	09.00-02.08	55/59			0 204 125 742	

	1.0 i, Twinport	09.99-02.08	43/44			0 204 031 174^A	
	1.2 i, Twinport	09.00-02.08	55/59			0 204 031 174^A	

Agila [B]





















	1.0 Twinport	MFD 03.08→	48-50		LLE	0 204 054 376	22,2
		OFD 03.08→	48-50		RLE	0 204 054 382	22,2
					LLE	0 204 054 366	22,2
					RLE	0 204 051 327	22,2
	1.2 Twinport	MFD 03.08→	63/69		LLE	0 204 054 376	22,2
	1.2 VVT				RLE	0 204 054 382	22,2
		OFD 03.08→	63/69		LLE	0 204 054 366	22,2
					RLE	0 204 051 327	22,2
	1.3 CDTI	MFD 03.08→	55		LLE	0 204 054 376	22,2
					RLE	0 204 054 382	22,2
		OFD 03.08→	55		LLE	0 204 054 366	22,2
					RLE	0 204 051 327	22,2

	1.0 Twinport	03.08→	48-50	Fg.-Nr. →AM999999		0 204 051 673	
		MFD 03.08→	48-50	Fg.-Nr. BM000001→	SSJ,TW	0 204 719 397	
						0 204 719 401	
					SSJ	0 204 054 136	
		OFD 03.08→	48-50	Fg.-Nr. BM000001→	SSJ,TW	0 204 719 396	
						0 204 719 400	
					SSJ	0 204 719 398	
	1.2 Twinport	03.08→	63/69	Fg.-Nr. →AM999999		0 204 051 673	
	1.2 VVT	MFD 03.08→	63/69		SSJ,TW	0 204 719 397	
				Fg.-Nr. BM000001→	SSJ	0 204 719 401	
		OFD 03.08→	63/69		SSJ,TW	0 204 054 136	
				Fg.-Nr. BM000001→	SSJ	0 204 719 396	
						0 204 719 400	
				Fg.-Nr. BM000001→	SSJ	0 204 719 398	
	1.3 CDTI	03.08→	55	Fg.-Nr. →AM999999		0 204 051 673	
		MFD 03.08→	55	Fg.-Nr. BM000001→	SSJ,TW	0 204 719 397	
						0 204 719 401	
					SSJ	0 204 054 136	
		OFD 03.08→	55	Fg.-Nr. BM000001→	SSJ,TW	0 204 719 396	
						0 204 719 400	
					SSJ	0 204 719 398	

Antara



	2.2 CDTI	11.10→	120/135			0 986 486 579	34
	2.2 CDTI 4x4						

		S							
Arena									
									
	1.9D	ABS	03.98-08.01	44			0 204 123 409		
	2.5	ABO	03.98-08.01	55	Fg.-Nr. B030138→		0 204 123 651	23,8	
		ABS	03.98-08.01	55	Fg.-Nr. B030138→		0 204 123 409		
	2.5D	ABO	03.98-08.01	55			0 204 123 651	23,8	
		ABS	03.98-08.01	55			0 204 123 409		
Astra									
									
	1.7 CDTI		01.12→	81/96	Get.-Nr. F17	TW	0 986 486 588	31	
Astra Convertible [F]									
									
	1.6 i		09.91-02.98	52/55		DEL,JBH	0 986 480 130	20,6	
			01.94-02.98	74		DEL,JBH,VEA	0 986 480 132	22,2	
		ABS	09.91-02.98	52/55/74		DEL,JBH	0 986 480 129	22,2	
						JBH ATE	0 986 480 907	22	
	1.8 i		09.91-02.98	66		DEL,JBH	0 986 480 130	20,6	
			09.94-02.98	85/92		DEL,JBH,VEA	0 986 480 132	22,2	
						DEL,JBH,VEA	0 986 480 132	22,2	
		ABS	09.91-02.98	66/85/92		DEL,JBH	0 986 480 129	22,2	
						JBH ATE	0 986 480 907	22	
	2.0 i		09.91-02.98	85		DEL,JBH,VEA	0 986 480 132	22,2	
			01.95-02.98	100		DEL,JBH,VEA	0 986 480 132	22,2	
		ABS	09.91-02.98	85/100		DEL,JBH	0 986 480 129	22,2	
						JBH ATE	0 986 480 907	22	
	1.6 i		09.91-02.98	52/55/74			0 265 208 311 ^H		
	1.8 i		09.91-02.98	66/85/92			0 265 208 311 ^H		
	2.0 i		09.91-02.98	85/100			0 265 208 311 ^H		
Astra Convertible [G]									
									
	1.6 i		09.00-08.05	74		JBH	0 986 480 699	23,8	
	1.6 i Twinport	MFD	03.03-08.05	76		JBH	0 986 481 028	23,81	
		OFD	03.03-08.05	76		JBH	0 986 480 699	23,8	
	1.8 i		09.00-08.05	92		JBH	0 986 480 699	23,8	
	2.0 i Turbo	MFD	03.02-08.05	141		JBH	0 986 481 028	23,81	
		OFD	03.02-08.05	141		JBH	0 986 480 699	23,8	
	2.2 i		09.00-08.05	108		JBH	0 986 480 699	23,8	
	1.6 i		09.00-08.05	74		LLE	0 986 486 068		
	1.8 i		09.00-08.05	92		LLE	0 986 486 068		
	2.0 i Turbo		03.02-08.05	141		LLE	0 986 486 068		
	2.2 i		09.00-08.05	108		LLE	0 986 486 068		
	1.6 i		09.00-08.05	74		F13	0 986 486 588	31	
						F23	0 986 486 586	34	
	1.6 i Twinport		03.03-08.05	76		F13	0 986 486 588	31	
	1.8 i		09.00-08.05	92		F13	0 986 486 588	31	
						F23	0 986 486 586	34	
	2.0 i Turbo		03.02-08.05	141		F23	0 986 486 586	34	
	2.2 i		09.00-08.05	108		F23	0 986 486 586	34	





◀ VAUXHALL Astra Convertible [G]

	1.6 i	09.00-08.05	74	Fg.-Nr. →12999999, →15999999, →16999999, →18999999, →1B999999	0 265 220 585^B
				Fg.-Nr. →32035797, →35033917, →38004448	0 265 202 492^T
				Fg.-Nr. 22000001→, 25000001→, 26000001→, 28000001→	0 265 220 637^F
				Fg.-Nr. 32035798→, 35033918→, 38004449→	0 265 202 509^T
	OFD	09.00-08.05	74		0 265 216 652^B
	1.6 i Twinport	03.03-08.05	76		0 265 202 509^T
	1.8 i	09.00-08.05	92	Fg.-Nr. →12999999, →15999999, →16999999, →18999999, →1B999999	0 265 220 585^B
				Fg.-Nr. →32035797, →35033917, →38004448	0 265 202 492^T
				Fg.-Nr. 22000001→, 25000001→, 26000001→, 28000001→	0 265 220 637^F
				Fg.-Nr. 32035798→, 35033918→, 38004449→	0 265 202 509^T
	2.0 i Turbo	03.02-08.05	141	Fg.-Nr. →32035797, →35033917, →38004448	0 265 202 492^T
				Fg.-Nr. 22000001→, 25000001→, 26000001→, 28000001→	0 265 220 637^F
				Fg.-Nr. 32035798→, 35033918→, 38004449→	0 265 202 509^T
	2.2 i	09.00-08.05	108	Fg.-Nr. →12999999, →15999999, →16999999, →18999999, →1B999999	0 265 220 585^B
				Fg.-Nr. →32035797, →35033917, →38004448	0 265 202 492^T
				Fg.-Nr. 22000001→, 25000001→, 26000001→, 28000001→	0 265 220 637^F
				Fg.-Nr. 32035798→, 35033918→, 38004449→	0 265 202 509^T













	1.6 i, i Twinport	09.00-08.05	74/76		0 265 005 262
	1.8 i	09.00-08.05	92		0 265 005 262
	2.0 i Turbo	03.02-08.05	141		0 265 005 262
	2.2 i	09.00-08.05	108		0 265 005 262

	1.6 i, i Twinport	09.00-08.05	74/76		0 265 005 435
	1.8 i	09.00-08.05	92		0 265 005 435
	2.0 i Turbo	03.02-08.05	141		0 265 005 435
	2.2 i	09.00-08.05	108		0 265 005 435

	1.6 i, i Twinport	09.00-08.05	74/76		0 265 005 303
	1.8 i	09.00-08.05	92		0 265 005 303
	2.0 i Turbo	03.02-08.05	141		0 265 005 303
	2.2 i	09.00-08.05	108		0 265 005 303

Astra Coupé [G]

	1.6 i Twinport	MFD	03.03-08.05	76	JBH	0 986 481 028	23,81
		OFD	03.03-08.05	76	JBH	0 986 480 699	23,8
	1.8 i	MFD	09.97-08.05	85/87-93	JBH	0 986 481 028	23,81
		OFD	09.97-08.05	85/87-93	JBH	0 986 480 699	23,8
	2.0 i Turbo	MFD	09.00-08.05	141	JBH	0 986 481 028	23,81
		OFD	09.00-08.05	141	JBH	0 986 480 699	23,8
	2.2 i	MFD	09.00-08.05	108	JBH	0 986 481 028	23,81
		OFD	09.00-08.05	108	JBH	0 986 480 699	23,8
	1.8 i		09.97-08.05	85/92	LLE	0 986 486 068	
	2.0 i Turbo		09.00-08.05	141	LLE	0 986 486 068	
	2.2 i		09.00-08.05	108	LLE	0 986 486 068	

		S							
	1.6 i Twinport	03.03-08.05	76			F13	0 986 486 588	31	
	1.8 i	09.97-08.00	85			F13	0 986 486 588	31	
						F23	0 986 486 586	34	
		09.00-08.05	92			F13	0 986 486 588	31	
						F23	0 986 486 586	34	
		03.01-08.05	85			F13	0 986 486 588	31	
						F23	0 986 486 586	34	
	1.8 i Dualfuel	09.02-08.05	87-93			F13	0 986 486 588	31	
	2.0 i Turbo	09.00-08.05	141			F23	0 986 486 586	34	
	2.2 i	09.00-08.05	108			F23	0 986 486 586	34	
	1.6 i Twinport	03.03-08.05	76				0 265 202 509 ^T		
	1.8 i	09.97-08.00	85				0 265 220 532 ^F		
		09.00-08.05	92			Fg.-Nr. →12999999, →15999999, →16999999, →18999999, →1B999999	0 265 220 585 ^B		
					Fg.-Nr. →32035797, →35033917, →38004448	0 265 202 492 ^T			
					Fg.-Nr. 22000001→, 25000001→, 26000001→, 28000001→	0 265 220 637 ^F			
					Fg.-Nr. 32035798→, 35033918→, 38004449→	0 265 202 509 ^T			
		03.01-08.05	85			Fg.-Nr. →32035797, →35033917, →38004448	0 265 202 492 ^T		
						Fg.-Nr. 22000001→, 25000001→, 26000001→, 28000001→	0 265 220 637 ^F		
						Fg.-Nr. 32035798→, 35033918→, 38004449→	0 265 202 509 ^T		
	1.8 i Dualfuel	09.02-08.05	87-93			Fg.-Nr. →12999999, →15999999, →16999999, →18999999, →1B999999	0 265 220 585 ^B		
						Fg.-Nr. →32035797, →35033917, →38004448	0 265 202 492 ^T		
						Fg.-Nr. 2B000001→2B999999	0 265 202 492 ^T		
						Fg.-Nr. 3B000001→	0 265 202 509 ^T		
						Fg.-Nr. 22000001→, 25000001→, 26000001→, 28000001→	0 265 220 637 ^F		
						Fg.-Nr. 32035798→, 35033918→, 38004449→	0 265 202 509 ^T		
	2.0 i Turbo	09.00-08.05	141			Fg.-Nr. →12999999, →15999999, →16999999, →18999999, →1B999999	0 265 220 585 ^B		
						Fg.-Nr. →32035797, →35033917, →38004448	0 265 202 492 ^T		
						Fg.-Nr. 22000001→, 25000001→, 26000001→, 28000001→	0 265 220 637 ^F		
						Fg.-Nr. 32035798→, 35033918→, 38004449→	0 265 202 509 ^T		
	2.2 i	09.00-08.05	108			Fg.-Nr. →12999999, →15999999, →16999999, →18999999, →1B999999	0 265 220 585 ^B		
					Fg.-Nr. →32035797, →35033917, →38004448	0 265 202 492 ^T			
					Fg.-Nr. 22000001→, 25000001→, 26000001→, 28000001→	0 265 220 637 ^F			
					Fg.-Nr. 32035798→, 35033918→, 38004449→	0 265 202 509 ^T			
	1.8 i, i Dualfuel	09.00-08.05	85/87-93				0 265 005 262		
	2.0 i Turbo	09.00-08.05	141				0 265 005 262		
	2.2 i	09.00-08.05	108				0 265 005 262		
	1.8 i, i Dualfuel	09.00-08.05	85/87-93				0 265 005 435		
	2.0 i Turbo	09.00-08.05	141				0 265 005 435		
	2.2 i	09.00-08.05	108				0 265 005 435		





◀ VAUXHALL Astra Coupé [G]

	1.6 i Twinport	03.03-08.05	76		0 265 005 303	
	1.8 i, i Dualfuel	09.00-08.05	85/87-93		0 265 005 303	
	2.0 i Turbo	09.00-08.05	141		0 265 005 303	
	2.2 i	09.00-08.05	108		0 265 005 303	













Astra Estate [F]

	1.4 i	09.90-02.98	44	DEL,JBH	0 986 480 130	20,6	
				DEL,JBH, VEA	0 986 480 132	22,2	
		03.92-02.98	60	DEL,JBH	0 986 480 130	20,6	
				JBH,VEA ATE	0 986 480 752	22,2	
		04.96-02.98	66	DEL,JBH	0 986 480 130	20,6	
				DEL,JBH, VEA	0 986 480 132	22,2	
	ABS	09.90-02.98	44/60/66	DEL,JBH	0 986 480 129	22,2	
				JBH ATE	0 986 480 907	22	
	1.6 i	09.91-02.98	52/55/74	DEL,JBH	0 986 480 130	20,6	
				DEL,JBH, VEA	0 986 480 132	22,2	
	ABS	09.91-02.98	52/55/74	DEL,JBH	0 986 480 129	22,2	
				JBH ATE	0 986 480 907	22	
	1.7 D/DR	12.91-02.98	42-44	DEL,JBH	0 986 480 130	20,6	
				JBH,VEA ATE	0 986 480 752	22,2	
	1.7 D/DR, DTL, TD	ABS	12.91-02.98	42-44/50/60	DEL,JBH	0 986 480 129	22,2
				JBH ATE	0 986 480 907	22	
	1.7 DTL	12.91-02.98	50/60	DEL,JBH	0 986 480 130	20,6	
	1.7 TD			DEL,JBH, VEA	0 986 480 132	22,2	
	1.8 i	09.91-02.98	66	DEL,JBH	0 986 480 130	20,6	
				DEL,JBH, VEA	0 986 480 132	22,2	
		09.94-02.98	85/92	DEL,JBH, VEA	0 986 480 132	22,2	
				JBH,VEA ATE	0 986 480 752	22,2	
	ABS	09.91-02.98	66/85/92	DEL,JBH	0 986 480 129	22,2	
				JBH ATE	0 986 480 907	22	
	2.0 i	09.91-02.98	85	DEL,JBH, VEA	0 986 480 132	22,2	
				JBH,VEA ATE	0 986 480 752	22,2	
			100/110	DEL,JBH, VEA	0 986 480 132	22,2	
	ABS	09.91-02.98	85/100/110	DEL,JBH	0 986 480 129	22,2	
				JBH ATE	0 986 480 907	22	

	1.4 i	09.90-02.98	44/60/66		0 265 208 311 ^H	
	1.6 i	09.91-02.98	52/55/74		0 265 208 311 ^H	
	1.7 D/DR, DTL, TD	12.91-02.98	42-44/50/60		0 265 208 311 ^H	
	1.8 i	09.91-02.98	66/85/92		0 265 208 311 ^H	
	2.0 i	09.91-02.98	85/100/110		0 265 208 311 ^H	

Astra Estate [G]













	1.2 i	09.97-08.05	48/55	4SB,JBH	0 986 480 699	23,8	
		MFD	09.97-08.05	48/55	JBH	0 986 481 028	23,81
	1.4 i	MFD	09.97-08.05	66	JBH	0 986 481 028	23,81
		OFD	09.97-08.05	66	JBH	0 986 480 699	23,8
	1.6 i	OFD	09.97-08.05	55/62	JBH	0 986 480 699	23,8
				74/76	JBH	0 986 480 699	23,8
	1.6 i Dualfuel	OFD	09.02-08.05	63-73	4SB,JBH	0 986 480 699	23,8

									
1.6 i, i Dualfuel	MFD	09.97-08.05	55/62/63-73/74/76			JBH	0 986 481 028	23,81	
1.7 CDTI	OFD	03.03-08.05	59			4SB,JBH	0 986 480 699	23,8	
1.7 CDTI, DT, DTI	MFD	03.98-08.05	50/55/59			JBH	0 986 481 028	23,81	
1.7 DT, DTI	OFD	03.98-08.05	50/55			JBH	0 986 480 699	23,8	
1.8 i	MFD	09.97-08.05	85/87-93			JBH	0 986 481 028	23,81	
1.8 i Dualfuel	OFD	09.97-08.05	85/87-93			JBH	0 986 480 699	23,8	
2.0 DTI, DTL, i, Turbo	MFD	09.97-08.05	60/74/100/141			JBH	0 986 481 028	23,81	
	OFD	09.97-08.05	60/74/100/141			JBH	0 986 480 699	23,8	
2.2 i	MFD	09.00-08.05	108			JBH	0 986 481 028	23,81	
	OFD	09.00-08.05	108			JBH	0 986 480 699	23,8	
	1.2 i	09.97-08.05	48/55			LLE	0 986 486 068		
	1.4 i	09.97-08.05	66			LLE	0 986 486 068		
	1.6 i	09.97-08.05	55/62/74			LLE	0 986 486 068		
	1.7 DT, DTI	03.98-08.05	50/55			LLE	0 986 486 068		
	1.8 i	09.97-08.05	85/92			LLE	0 986 486 068		
	2.0 DTI, DTL, i, Turbo	09.97-08.05	60/74/100/141			LLE	0 986 486 068		
	2.2 i	09.00-08.05	108			LLE	0 986 486 068		
	1.2 i	09.97-08.05	48/55			F13	0 986 486 588	31	
						F23	0 986 486 586	34	
	1.4 i	09.97-08.05	66			F13	0 986 486 588	31	
						F23	0 986 486 586	34	
	1.6 i	09.97-08.05	55/62			F13	0 986 486 588	31	
						F23	0 986 486 586	34	
			74			F13	0 986 486 588	31	
						F23	0 986 486 586	34	
	1.6 i Dualfuel	09.02-08.05	63-73				0 986 486 588	31	
	1.7 CDTI	03.03-08.05	59			F13	0 986 486 588	31	
	1.7 DT	03.98-08.05	50/55			F13	0 986 486 588	31	
	1.7 DTI					F23	0 986 486 586	34	
	1.8 i	09.97-08.00	85			F13	0 986 486 588	31	
						F23	0 986 486 586	34	
		09.00-08.05	92			F13	0 986 486 588	31	
						F23	0 986 486 586	34	
	1.8 i Dualfuel	09.02-08.05	87-93			F13	0 986 486 588	31	
	2.0 DTI, DTL, i	09.97-08.05	60/74/100			F18	0 986 486 593	34	
						F23	0 986 486 586	34	
	2.0 Turbo	09.02-08.05	141			F23	0 986 486 586	34	
	2.2 i	09.00-08.05	108			F23	0 986 486 586	34	
	1.2 i	09.97-08.05	48/55	Fg.-Nr. →X2014819, →X5009355, →X6006066			0 265 216 474 ^B		
				Fg.-Nr. →X8005679			0 265 216 474 ^B		
		OFD 09.97-08.05	48/55	Fg.-Nr. X2014820→, X5009356→, X6006067→, X8005680→			0 265 216 652 ^B		
	1.4 i	09.97-08.00	66	Fg.-Nr. →X2014819, →X5009355, →X6006066			0 265 216 474 ^B		
				Fg.-Nr. →X8005679			0 265 216 474 ^B		
		09.00-08.05	66	Fg.-Nr. →12999999, →15999999, →16999999, →18999999, →1B999999			0 265 220 585 ^B		
		OFD 09.97-08.05	66	Fg.-Nr. X2014820→, X5009356→, X6006067→, X8005680→			0 265 216 652 ^B		
	1.6 i	09.97-08.05	55	Fg.-Nr. →X2014819, →X5009355, →X6006066			0 265 216 474 ^B		
				Fg.-Nr. →X8005679			0 265 216 474 ^B		
			74	Fg.-Nr. →X2014819, →X5009355, →X6006066			0 265 216 474 ^B		
				Fg.-Nr. →X8005679			0 265 216 474 ^B		
		09.98-08.05	74	Fg.-Nr. →12999999, →15999999, →16999999, →18999999, →1B999999			0 265 220 585 ^B		



1.6 i	09.00-08.05	62	Fg.-Nr. →12999999, →15999999, →16999999, →18999999, →1B999999			0 265 220 585 ^B							
			Fg.-Nr. →32035797, →35033917, →38004448			0 265 202 492 ^T							
			Fg.-Nr. 22000001→, 25000001→, 26000001→, 28000001→			0 265 220 637 ^F							
			Fg.-Nr. 32035798→, 35033918→, 38004449→			0 265 202 509 ^T							
			74	Fg.-Nr. →32035797, →35033917, →38004448			0 265 202 492 ^T						
				Fg.-Nr. 22000001→, 25000001→, 26000001→, 28000001→			0 265 220 637 ^F						
				Fg.-Nr. 32035798→, 35033918→, 38004449→			0 265 202 509 ^T						
			09.02-08.05	76	Fg.-Nr. →12999999, →15999999, →16999999, →18999999, →1B999999			0 265 220 585 ^B					
					Fg.-Nr. 22000001→, 25000001→, 26000001→, 28000001→			0 265 220 637 ^F					
								0 265 202 509 ^T					
OFD	09.97-08.05	55	Fg.-Nr. X2014820→, X5009356→, X6006067→, X8005680→			0 265 216 652 ^B							
			74	Fg.-Nr. X2014820→, X5009356→, X6006067→, X8005680→			0 265 216 652 ^B						
	09.00-08.05	62					0 265 216 652 ^B						
1.6 i Dualfuel	09.02-08.05	63-73				0 265 202 509 ^T							
						0 265 216 652 ^B							
			Fg.-Nr. →32035797, →35033917, →38004448			0 265 202 492 ^T							
			Fg.-Nr. 22000001→, 25000001→, 26000001→, 28000001→			0 265 220 637 ^F							
1.7 CDTI	03.03-08.05	59				0 265 216 652 ^B							
			Fg.-Nr. 22000001→, 25000001→, 26000001→, 28000001→			0 265 220 637 ^F							
1.7 DT	03.98-08.00	50	Fg.-Nr. →X2014819, →X5009355, →X6006066			0 265 216 474 ^B							
			Fg.-Nr. →X8005679			0 265 216 474 ^B							
OFD	03.98-08.00	50	Fg.-Nr. X2014820→, X5009356→, X6006067→, X8005680→			0 265 216 652 ^B							
1.7 DTI	09.00-08.05	55	Fg.-Nr. →12999999, →15999999, →16999999, →18999999, →1B999999			0 265 220 585 ^B							
			Fg.-Nr. 22000001→, 25000001→, 26000001→, 28000001→			0 265 220 637 ^F							
			OFD	09.00-08.05	55				0 265 216 652 ^B				
1.8 i	09.97-08.00	85	Fg.-Nr. →X2040738, →X5028417, →X6006066, →X8013993			0 265 220 450 ^F							
			Fg.-Nr. X2040739→, X5028418→, X6006067→, X8013994→			0 265 220 532 ^F							
1.8 i	09.00-08.05	87-93	Fg.-Nr. →12999999, →15999999, →16999999, →18999999, →1B999999			0 265 220 585 ^B							
			Fg.-Nr. →32035797, →35033917, →38004448			0 265 202 492 ^T							
1.8 i Dualfuel	09.00-08.05	87-93	Fg.-Nr. 22000001→, 25000001→, 26000001→, 28000001→			0 265 220 637 ^F							
			Fg.-Nr. 32035798→, 35033918→, 38004449→			0 265 202 509 ^T							
2.0 DTI	OFD	09.00-08.05	74				0 265 216 652 ^B						
2.0 DTI	09.97-08.05	74/100	Fg.-Nr. →12999999, →15999999, →16999999, →18999999, →1B999999			0 265 220 585 ^B							
			Fg.-Nr. →32035797, →35033917, →38004448			0 265 202 492 ^T							
2.0 i	09.00-08.05	87-93	Fg.-Nr. 22000001→, 25000001→, 26000001→, 28000001→			0 265 220 637 ^F							
			Fg.-Nr. 32035798→, 35033918→, 38004449→			0 265 202 509 ^T							



		S							
2.0 DTI			09.97-08.05	74/100	Fg.-Nr. 32035798→, 35033918→, 38004449→		0 265 202 509 ^T		
2.0 i									
2.0 DTL			03.98-08.00	60	Fg.-Nr. →X2014819, →X5009355, →X6006066		0 265 216 474 ^B		
					Fg.-Nr. →X8005679		0 265 216 474 ^B		
			03.98-08.05	60	Fg.-Nr. →32035797, →35033917, →38004448		0 265 202 492 ^T		
					Fg.-Nr. 32035798→, 35033918→, 38004449→		0 265 202 509 ^T		
			09.00-08.05	60	Fg.-Nr. →12999999, →15999999, →16999999, →18999999, →1B999999		0 265 220 585 ^B		
					Fg.-Nr. 22000001→, 25000001→, 26000001→, 28000001→		0 265 220 637 ^F		
		OFD	03.98-08.05	60	Fg.-Nr. X2014820→, X5009356→, X6006067→, X8005680→		0 265 216 652 ^B		
			09.00-08.05	60	Fg.-Nr. X8005680→		0 265 216 652 ^B		
2.0 i		MFD	09.97-08.05	100			0 265 202 458 ^B		
2.0 Turbo			09.02-08.05	141	Fg.-Nr. →32035797, →35033917, →38004448		0 265 202 492 ^T		
					Fg.-Nr. 22000001→, 25000001→, 26000001→, 28000001→		0 265 220 637 ^F		
					Fg.-Nr. 32035798→, 35033918→, 38004449→		0 265 202 509 ^T		
2.2 i			09.00-08.05	108	Fg.-Nr. →12999999, →15999999, →16999999, →18999999, →1B999999		0 265 220 585 ^B		
					Fg.-Nr. →32035797, →35033917, →38004448		0 265 202 492 ^T		
					Fg.-Nr. 22000001→, 25000001→, 26000001→, 28000001→		0 265 220 637 ^F		
					Fg.-Nr. 32035798→, 35033918→, 38004449→		0 265 202 509 ^T		
	1.6 i, i Dualfuel		09.00-08.05	62/63-73/74/76			0 265 005 262		
	1.8 i, i Dualfuel		09.97-08.05	85/87-93			0 265 005 262		
	2.0 DTI, i, Turbo		09.97-08.05	74/100/141			0 265 005 262		
	2.0 DTL		03.98-08.00	60	Fg.-Nr. →12999999, →1H999999		0 265 005 262		
			09.00-08.05	60			0 265 005 262		
	2.2 i		09.00-08.05	108			0 265 005 262		
	1.6 i, i Dualfuel		09.00-08.05	62/63-73/74/76			0 265 005 435		
	1.8 i, i Dualfuel		09.97-08.05	85/87-93			0 265 005 435		
	2.0 DTI		09.00-08.05	74			0 265 005 435		
	2.0 DTL		03.98-08.00	60	Fg.-Nr. 22000001→, 2H000001→		0 265 005 435		
			09.00-08.05	60			0 265 005 435		
	2.0 i		09.97-08.05	100	Fg.-Nr. 22000001→, 2H000001→		0 265 005 435		
	2.0 Turbo		09.02-08.05	141			0 265 005 435		
	2.2 i		09.00-08.05	108			0 265 005 435		
	1.6 i		09.00-08.05	62/74			0 265 005 303		
	1.8 i, i Dualfuel		09.97-08.05	85/87-93			0 265 005 303		
	2.0 DTI, DTL, i, Turbo		09.97-08.05	60/74/100/141			0 265 005 303		
	2.2 i		09.00-08.05	108			0 265 005 303		
Astra Estate [H]									
									
	1.2 Twinport	MFD	03.07-03.09	59	Fg.-Nr. →62999999, JBH,LLE, →65999999, →68999999 RLE		0 986 480 856	25,4	
					Fg.-Nr. 72000001→, LLE,RLE 75000001→, 78000001→		0 986 481 059	25,4	
		OFD	03.07-03.09	59	Fg.-Nr. →62999999, JBH,LLE →65999999, →68999999		0 986 480 880	25,4	



		S							
1.2	Twinport	OFD	03.07-03.09	59	Fg.-Nr. 72000001→, 75000001→, 78000001→	LLE	0986 481 058	25,4	
1.3	CDTI	MFD	06.05-03.10	66	Fg.-Nr. →62999999, →65999999, →68999999	JBH ,LLE, RLE	0986 480 856	25,4	
		OFD	06.05-03.10	66	Fg.-Nr. 72000001→, 75000001→, 78000001→	LLE,RLE	0986 481 059	25,4	
		OFD	06.05-03.10	66	Fg.-Nr. →62999999, →65999999, →68999999	JBH ,LLE	0986 480 880	25,4	
					Fg.-Nr. 72000001→, 75000001→, 78000001→	LLE	0986 481 058	25,4	
1.4	Twinport	MFD	08.04-03.10	55/66	Fg.-Nr. →62999999, →65999999, →68999999	JBH ,LLE, RLE	0986 480 856	25,4	
		OFD	08.04-03.10	55/66	Fg.-Nr. 72000001→, 75000001→, 78000001→	LLE,RLE	0986 481 059	25,4	
		OFD	08.04-03.10	55/66	Fg.-Nr. →62999999, →65999999, →68999999	JBH ,LLE	0986 480 880	25,4	
					Fg.-Nr. 72000001→, 75000001→, 78000001→	LLE	0986 481 058	25,4	
1.6	Turbo	MFD	09.07-03.10	85/132	Fg.-Nr. →62999999, →65999999, →68999999	JBH ,LLE, RLE	0986 480 856	25,4	
		OFD	09.07-03.10	85/132	Fg.-Nr. 72000001→, 75000001→, 78000001→	LLE,RLE	0986 481 059	25,4	
		OFD	09.07-03.10	85/132	Fg.-Nr. →62999999, →65999999, →68999999	JBH ,LLE	0986 480 880	25,4	
					Fg.-Nr. 72000001→, 75000001→, 78000001→	LLE	0986 481 058	25,4	
1.6	Twinport	MFD	08.04-03.07	77	Fg.-Nr. →62999999, →65999999, →68999999	JBH ,LLE, RLE	0986 480 856	25,4	
			09.07-03.09	77	Fg.-Nr. 72000001→, 75000001→, 78000001→	LLE,RLE	0986 481 059	25,4	
		OFD	08.04-03.07	77	Fg.-Nr. →62999999, →65999999, →68999999	JBH ,LLE	0986 480 880	25,4	
			09.07-03.09	77	Fg.-Nr. 72000001→, 75000001→, 78000001→	LLE	0986 481 058	25,4	
		OFD	08.04-03.07	77	Fg.-Nr. →62999999, →65999999, →68999999	JBH ,LLE	0986 480 880	25,4	
			09.07-03.09	77	Fg.-Nr. 72000001→, 75000001→, 78000001→	LLE	0986 481 058	25,4	
1.7	CDTI		03.10-12.12	81/92		TW	0986 481 058	25,4	
							0986 481 059	25,4	
		MFD	08.04-03.10	59/74/81/ 92	Fg.-Nr. →62999999, →65999999, →68999999	JBH ,LLE, RLE	0986 480 856	25,4	
		OFD	08.04-03.10	59/74/81/ 92	Fg.-Nr. 72000001→, 75000001→, 78000001→	LLE,RLE	0986 481 059	25,4	
		OFD	08.04-03.10	59/74/81/ 92	Fg.-Nr. →62999999, →65999999, →68999999	JBH ,LLE	0986 480 880	25,4	
					Fg.-Nr. 72000001→, 75000001→, 78000001→	LLE	0986 481 058	25,4	
1.8 i			07.10-09.13	103		TW	0986 481 058	25,4	
							0986 481 059	25,4	
		MFD	08.04-03.10	92/103	Fg.-Nr. →62999999, →65999999, →68999999	JBH ,LLE, RLE	0986 480 856	25,4	
		OFD	08.04-03.10	92/103	Fg.-Nr. 72000001→, 75000001→, 78000001→	LLE,RLE	0986 481 059	25,4	
		OFD	08.04-03.10	92/103	Fg.-Nr. →62999999, →65999999, →68999999	JBH ,LLE	0986 480 880	25,4	
					Fg.-Nr. 72000001→, 75000001→, 78000001→	LLE	0986 481 058	25,4	



		S							
2.0 Turbo	MFD	08.04-03.10	125/147/177	Fg.-Nr. →62999999, →65999999, →68999999	JBH,LLE, RLE		0 986 480 856	25,4	
2.0 Turbo 16V				Fg.-Nr. 72000001→, 75000001→, 78000001→	LLE,RLE		0 986 481 059	25,4	
	OFD	08.04-03.10	125/147/177	Fg.-Nr. →62999999, →65999999, →68999999	JBH,LLE		0 986 480 880	25,4	
				Fg.-Nr. 72000001→, 75000001→, 78000001→	LLE		0 986 481 058	25,4	
1.2 Twinport		03.07-03.09	59		LLE		0 986 486 068		
1.6, Turbo, Twinport		09.07-03.10	77/85/132		LLE		0 986 486 068		
1.7 CDTI		03.10-12.12	81/92		LLE		0 986 486 068		
1.8i		08.05-03.10	103		LLE		0 986 486 068		
		07.10-09.13	103		LLE		0 986 486 068		
1.9 CDTI		09.05-03.10	74/88		LLE		0 986 486 068		
1.2 Twinport		03.07-03.09	59	Get.-Nr. M 20→	EAY		0 986 486 589	34	
1.3 CDTI		06.05-03.10	66	Get.-Nr. F13	TW		0 986 486 584	31	
				Get.-Nr. F13, Get.-Nr. F17	TW		0 986 486 588	31	
				Get.-Nr. M20	EAY		0 986 486 589	34	
				Get.-Nr. M20, Get.-Nr. M32	GS		0 986 486 591	34	
1.4		08.04-03.10	55/66	Get.-Nr. F13	TW		0 986 486 584	31	
1.4 Twinport				Get.-Nr. F13, Get.-Nr. F17	TW		0 986 486 588	31	
				Get.-Nr. M20	EAY		0 986 486 589	34	
					GS		0 986 486 591	34	
1.6		09.07-03.10	85	Get.-Nr. F13	TW		0 986 486 584	31	
				Get.-Nr. F13, Get.-Nr. F17	TW		0 986 486 588	31	
				Get.-Nr. M20	EAY		0 986 486 589	34	
					GS		0 986 486 591	34	
1.6 Turbo		09.07-03.10	132	Get.-Nr. F13	TW		0 986 486 584	31	
				Get.-Nr. F13, Get.-Nr. F17	TW		0 986 486 588	31	
				Get.-Nr. M20	EAY		0 986 486 589	34	
				Get.-Nr. M20, Get.-Nr. M32	GS		0 986 486 591	34	
1.6 Twinport		08.04-03.07	77				0 986 486 588	31	
		09.07-03.09	77	Get.-Nr. F13	TW		0 986 486 584	31	
				Get.-Nr. F13, Get.-Nr. F17	TW		0 986 486 588	31	
				Get.-Nr. M20	EAY		0 986 486 589	34	
					GS		0 986 486 591	34	
1.7 CDTI		08.04-03.07	59/74				0 986 486 588	31	
		03.07-03.10	81		EAY		0 986 486 588	31	
					EAY		0 986 486 594	34	
		05.07-03.10	92		EAY		0 986 486 588	31	
					EAY		0 986 486 594	34	
		03.10-12.12	81	Get.-Nr. F13	GS,TW		0 986 486 584	31	
				Get.-Nr. F13, Get.-Nr. F17	EAY,GS,TW		0 986 486 588	31	
				Get.-Nr. M20	EAY		0 986 486 589	34	
					GS,TW		0 986 486 591	34	
					MG6		0 986 486 591	34	
				Get.-Nr. M32	GS,TW		0 986 486 594	34	
					MG6		0 986 486 594	34	
			92	Get.-Nr. F13	GS,TW		0 986 486 584	31	
				Get.-Nr. F13, Get.-Nr. F17	EAY,GS,TW		0 986 486 588	31	
				Get.-Nr. M20	EAY		0 986 486 589	34	
					GS,TW		0 986 486 591	34	
				Get.-Nr. M32	GS,TW		0 986 486 594	34	
1.8i		08.04-02.09	92				0 986 486 588	31	
		08.05-03.10	103	Get.-Nr. F13	TW		0 986 486 584	31	
				Get.-Nr. F13, Get.-Nr. F17	TW		0 986 486 588	31	
				Get.-Nr. M20	EAY		0 986 486 589	34	
					GS		0 986 486 591	34	





	◀ VAUXHALL Astra Estate [H]							
1.8 i	07.10-09.13	103	Get.-Nr. F13	GS,TW	0986 486 584	31		
			Get.-Nr. F13, Get.-Nr. F17	EAY,GS,TW	0986 486 588	31		
			Get.-Nr. M20	EAY,TW	0986 486 589	34		
				GS,TW	0986 486 591	34		
1.9 CDTI	08.04-03.10	74/88/110			0986 486 590	34		
2.0 Turbo	09.05-03.10	177			0986 486 588	31		

Astra [F]

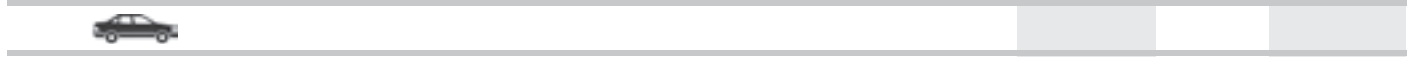











	1.4 i	09.90-02.98	44		DEL,JBH	0986 480 130	20,6	
					DEL,JBH, VEA	0986 480 132	22,2	
		03.92-02.98	60		DEL,JBH	0986 480 130	20,6	
					JBH,VEA ATE	0986 480 752	22,2	
		04.96-02.98	66		DEL,JBH	0986 480 130	20,6	
					DEL,JBH, VEA	0986 480 132	22,2	
	ABS	09.90-02.98	44/60/66		DEL,JBH	0986 480 129	22,2	
					JBH ATE	0986 480 907	22	
	1.6 i	09.91-02.98	52/55/74		DEL,JBH	0986 480 130	20,6	
					DEL,JBH, VEA	0986 480 132	22,2	
	ABS	09.91-02.98	52/55/74		DEL,JBH	0986 480 129	22,2	
					JBH ATE	0986 480 907	22	
	1.7 D/DR	12.91-02.98	42-44		DEL,JBH	0986 480 130	20,6	
					JBH,VEA ATE	0986 480 752	22,2	
	1.7 D/DR, DTL, TD	ABS	12.91-02.98	42-44/50/60	DEL,JBH	0986 480 129	22,2	
					JBH ATE	0986 480 907	22	
	1.7 DTL	12.91-02.98	50/60		DEL,JBH	0986 480 130	20,6	
	1.7 TD				DEL,JBH, VEA	0986 480 132	22,2	
	1.8 i	09.91-02.98	66		DEL,JBH	0986 480 130	20,6	
					DEL,JBH, VEA	0986 480 132	22,2	
		09.94-02.98	85/92		DEL,JBH, VEA	0986 480 132	22,2	
					JBH,VEA ATE	0986 480 752	22,2	
		06.96-02.98	82		DEL,JBH, VEA	0986 480 132	22,2	
	ABS	09.91-02.98	66/82/85/92		DEL,JBH	0986 480 129	22,2	
					JBH ATE	0986 480 907	22	
	2.0 i	09.91-02.98	85		DEL,JBH, VEA	0986 480 132	22,2	
					JBH,VEA ATE	0986 480 752	22,2	
			100/110		DEL,JBH, VEA	0986 480 132	22,2	
	ABS	09.91-02.98	85/100/110		DEL,JBH	0986 480 129	22,2	
					JBH ATE	0986 480 907	22	

	1.4 i	09.90-02.98	44/60/66			0265 208 311 ^H		
	1.6 i	09.91-02.98	52/55/74			0265 208 311 ^H		
	1.7 D/DR, DTL, TD	12.91-02.98	42-44/50/60			0265 208 311 ^H		
	1.8 i	09.91-02.98	66/85/92			0265 208 311 ^H		
	2.0 i	09.91-02.98	85/100/110			0265 208 311 ^H		

Astra [G]















	1.2 i	09.97-08.05	48/55		4SB,JBH	0986 480 699	23,8	
		MFD	09.97-08.05	48/55	JBH	0986 481 028	23,81	
	1.4 i	MFD	09.97-08.05	66	JBH	0986 481 028	23,81	
		OFD	09.97-08.05	66	JBH	0986 480 699	23,8	









		S							
1.6 i	MFD	09.97-08.05	55/62/63-73/74/76			JBH	0 986 481 028	23,81	
1.6 i Dualfuel	OFD	09.97-08.05	55/62/63-73/74/76			JBH	0 986 480 699	23,8	
1.7 CDTI 16V	OFD	03.03-08.05	59			4SB, JBH	0 986 480 699	23,8	
1.7 CDTI 16V, DT, DTI	MFD	03.98-08.05	50/55/59			JBH	0 986 481 028	23,81	
1.7 DT, DTI	OFD	03.98-08.05	50/55			JBH	0 986 480 699	23,8	
1.8 i	MFD	09.97-08.05	85/87-93			JBH	0 986 481 028	23,81	
1.8 i Dualfuel	OFD	09.97-08.05	85/87-93			JBH	0 986 480 699	23,8	
2.0 DTI, DTL, i	OFD	09.97-08.05	60/74/100/118			JBH	0 986 480 699	23,8	
2.0 DTI, DTL, i, Turbo	MFD	09.97-08.05	60/74/100/118/141			JBH	0 986 481 028	23,81	
2.0 Turbo	OFD	07.02-08.05	141			4SB, JBH	0 986 480 699	23,8	
2.2 DTI	MFD	09.00-08.05	92/108			JBH	0 986 481 028	23,81	
2.2 i	OFD	09.00-08.05	92/108			JBH	0 986 480 699	23,8	
	1.2 i	09.97-08.05	48/55			LLE	0 986 486 068		
	1.4 i	09.97-08.05	66			LLE	0 986 486 068		
	1.6 i	09.97-08.05	55/62/74			LLE	0 986 486 068		
	1.7 DT, DTI	03.98-08.05	50/55			LLE	0 986 486 068		
	1.8 i	09.97-08.05	85/92			LLE	0 986 486 068		
	2.0 DTI, DTL, i	09.97-08.05	60/74/100/118			LLE	0 986 486 068		
	2.2 i	09.00-08.05	108			LLE	0 986 486 068		
	1.2 i	09.97-08.05	48/55			F13	0 986 486 588	31	
						F23	0 986 486 586	34	
	1.4 i	09.97-08.05	66			F13	0 986 486 588	31	
						F23	0 986 486 586	34	
	1.6 i	09.97-08.05	55/62/74			F13	0 986 486 588	31	
						F23	0 986 486 586	34	
	1.7 CDTI 16V	03.03-08.05	59			F13	0 986 486 588	31	
	1.7 DT	03.98-08.05	50/55			F13	0 986 486 588	31	
	1.7 DTI					F23	0 986 486 586	34	
	1.8 i	09.97-08.00	85			F13	0 986 486 588	31	
						F23	0 986 486 586	34	
		09.00-08.05	92			F13	0 986 486 588	31	
						F23	0 986 486 586	34	
	1.8 i Dualfuel	09.02-08.05	87-93			F13	0 986 486 588	31	
	2.0 DTI, DTL, i	09.97-08.05	60/74/100			F18	0 986 486 593	34	
						F23	0 986 486 586	34	
	2.2 i	09.00-08.05	108			F23	0 986 486 586	34	
	1.2 i	09.97-08.00	48				0 265 216 474^B		
						Fg.-Nr. →X2014819, →X5009355, →X6006066			
						Fg.-Nr. →X8005679	0 265 216 474^B		
		OFD 09.97-08.05	48/55			Fg.-Nr. X2014820→, X5009356→, X6006067→, X8005680→	0 265 216 652^B		
	1.4 i	09.97-08.00	66			Fg.-Nr. →X2014819, →X5009355, →X6006066	0 265 216 474^B		
						Fg.-Nr. →X8005679	0 265 216 474^B		
		09.00-08.05	66			Fg.-Nr. →12999999, →15999999, →16999999, →18999999, →1B999999	0 265 220 585^B		
		OFD 09.97-08.05	66			Fg.-Nr. X2014820→, X5009356→, X6006067→, X8005680→	0 265 216 652^B		
	1.6 i	09.97-08.05	55			Fg.-Nr. →X2014819, →X5009355, →X6006066	0 265 216 474^B		
						Fg.-Nr. →X8005679	0 265 216 474^B		
			74			Fg.-Nr. →X2014819, →X5009355, →X6006066	0 265 216 474^B		
						Fg.-Nr. →X8005679	0 265 216 474^B		
		09.98-08.05	74			Fg.-Nr. →12999999, →15999999, →16999999, →18999999, →1B999999	0 265 220 585^B		
		09.00-08.05	74			Fg.-Nr. →32035797, →35033917, →38004448	0 265 202 492^T		

		S								
◀ VAUXHALL Astra [G]										
1.6 i	09.00-08.05	74	Fg.-Nr. 22000001→, 25000001→, 26000001→, 28000001→				0 265 220 637 ^F			
			Fg.-Nr. 32035798→, 35033918→, 38004449→				0 265 202 509 ^T			
1.6 i	09.02-08.05	76	Fg.-Nr. →12999999, →15999999, →16999999, →18999999, →1B999999				0 265 202 509 ^T			
			Fg.-Nr. 22000001→, 25000001→, 26000001→, 28000001→				0 265 220 637 ^F			
			OFD 09.97-08.05	55	Fg.-Nr. X2014820→, X5009356→, X6006067→, X8005680→				0 265 216 652 ^B	
74	Fg.-Nr. X2014820→, X5009356→, X6006067→, X8005680→				0 265 216 652 ^B					
	09.00-08.05	62					0 265 216 652 ^B			
1.6 i	09.00-08.05	62/63-73	Fg.-Nr. →12999999, →15999999, →16999999, →18999999, →1B999999				0 265 220 585 ^B			
1.6 i Dualfuel			Fg.-Nr. →32035797, →35033917, →38004448				0 265 202 492 ^T			
			Fg.-Nr. 22000001→, 25000001→, 26000001→, 28000001→				0 265 220 637 ^F			
			Fg.-Nr. 32035798→, 35033918→, 38004449→				0 265 202 509 ^T			
1.7 CDTi 16V	03.03-08.05	59					0 265 216 652 ^B			
			Fg.-Nr. 22000001→, 25000001→, 26000001→, 28000001→				0 265 220 637 ^F			
1.7 DT	03.98-08.00	50	Fg.-Nr. →X2014819, →X5009355, →X6006066				0 265 216 474 ^B			
			Fg.-Nr. →X8005679				0 265 216 474 ^B			
OFD 1.7 DTi	03.98-08.00	50	Fg.-Nr. X2014820→, X5009356→, X6006067→, X8005680→				0 265 216 652 ^B			
			09.00-08.05	55	Fg.-Nr. →12999999, →15999999, →16999999, →18999999, →1B999999				0 265 220 585 ^B	
Fg.-Nr. 22000001→, 25000001→, 26000001→, 28000001→					0 265 220 637 ^F					
OFD 1.8 i	09.00-08.05	55					0 265 216 652 ^B			
1.8 i	09.97-08.00	85	Fg.-Nr. →X2040738, →X5028417, →X6006066, →X8013993				0 265 220 450 ^F			
			Fg.-Nr. X2040739→, X5028418→, X6006067→, X8013994→				0 265 220 532 ^F			
1.8 i	09.00-08.05	87-93	Fg.-Nr. →12999999, →15999999, →16999999, →18999999, →1B999999				0 265 220 585 ^B			
			Fg.-Nr. →32035797, →35033917, →38004448				0 265 202 492 ^T			
			Fg.-Nr. 22000001→, 25000001→, 26000001→, 28000001→				0 265 220 637 ^F			
1.8 i Dualfuel			Fg.-Nr. 32035798→, 35033918→, 38004449→				0 265 202 509 ^T			
							0 265 220 637 ^F			
2.0 DTi	OFD 09.00-08.05	74					0 265 216 652 ^B			
2.0 DTi	09.97-08.05	74/100/118	Fg.-Nr. →12999999, →15999999, →16999999, →18999999, →1B999999				0 265 220 585 ^B			
			Fg.-Nr. →32035797, →35033917, →38004448				0 265 202 492 ^T			
2.0 i			Fg.-Nr. 22000001→, 25000001→, 26000001→, 28000001→				0 265 220 637 ^F			
			Fg.-Nr. 32035798→, 35033918→, 38004449→				0 265 202 509 ^T			
2.0 DTL	03.98-08.00	60	Fg.-Nr. →X2014819, →X5009355, →X6006066				0 265 216 474 ^B			
			Fg.-Nr. →X8005679				0 265 216 474 ^B			
2.0 DTL	03.98-08.05	60	Fg.-Nr. →32035797, →35033917, →38004448				0 265 202 492 ^T			
			Fg.-Nr. 32035798→, 35033918→, 38004449→				0 265 202 509 ^T			



		S							
2.0 DTL		09.00-08.05	60	Fg.-Nr. →12999999, →15999999, →16999999, →18999999, →1B999999			0 265 220 585^B		
				Fg.-Nr. 22000001→, 25000001→, 26000001→, 28000001→			0 265 220 637^F		
	OFD	03.98-08.05	60	Fg.-Nr. X2014820→, X5009356→, X6006067→, X8005680→			0 265 216 652^B		
		09.00-08.05	60	Fg.-Nr. X8005680→			0 265 216 652^B		
2.0i	MFD	09.97-08.05	100				0 265 202 458^B		
	OFD	09.00-08.05	118				0 265 220 532^F		
2.0 Turbo		07.02-08.05	141				0 265 220 585^B		
				Fg.-Nr. →32035797, →35033917, →38004448			0 265 202 492^T		
				Fg.-Nr. 22000001→, 25000001→, 26000001→, 28000001→			0 265 220 637^F		
				Fg.-Nr. 32035798→, 35033918→, 38004449→			0 265 202 509^T		
2.2 DTI		09.01-08.05	92	Fg.-Nr. →32035797, →35033917, →38004448			0 265 202 492^T		
				Fg.-Nr. 22000001→, 25000001→, 26000001→, 28000001→			0 265 220 637^F		
				Fg.-Nr. 32035798→, 35033918→, 38004449→			0 265 202 509^T		
2.2i		09.00-08.05	108	Fg.-Nr. →12999999, →15999999, →16999999, →18999999, →1B999999			0 265 220 585^B		
				Fg.-Nr. →32035797, →35033917, →38004448			0 265 202 492^T		
				Fg.-Nr. 22000001→, 25000001→, 26000001→, 28000001→			0 265 220 637^F		
				Fg.-Nr. 32035798→, 35033918→, 38004449→			0 265 202 509^T		
	1.6 i, i Dualfuel	09.00-08.05	62/63-73/74/76				0 265 005 262		
	1.8 i, i Dualfuel	09.97-08.05	85/87-93				0 265 005 262		
	2.0 DTI	09.00-08.05	74				0 265 005 262		
	2.0 DTL	03.98-08.00	60	Fg.-Nr. →12999999, →1H999999			0 265 005 262		
		09.00-08.05	60				0 265 005 262		
	2.0i	09.97-08.05	100	Fg.-Nr. →12999999, →1H999999			0 265 005 262		
				Fg.-Nr. 22000001→, 2B000001→, 2H000001→			0 265 005 262		
	2.0i, Turbo	09.00-08.05	118/141				0 265 005 262		
	2.2 DTI, i	09.00-08.05	92/108				0 265 005 262		
	1.6 i, i Dualfuel	09.00-08.05	62/63-73/74/76				0 265 005 435		
	1.8 i, i Dualfuel	09.97-08.05	85/87-93				0 265 005 435		
	2.0 DTI	09.00-08.05	74				0 265 005 435		
	2.0 DTL	03.98-08.00	60	Fg.-Nr. 22000001→, 2H000001→			0 265 005 435		
		09.00-08.05	60				0 265 005 435		
	2.0i	09.97-08.05	100	Fg.-Nr. 22000001→, 2H000001→			0 265 005 435		
	2.0i, Turbo	09.00-08.05	118/141				0 265 005 435		
	2.2 DTI, i	09.00-08.05	92/108				0 265 005 435		
	1.6i	09.00-08.05	62/74				0 265 005 303		
	1.8i, i Dualfuel	09.97-08.05	85/87-93				0 265 005 303		
	2.0 DTI, DTL, i, Turbo	09.97-08.05	60/74/100/118/141				0 265 005 303		
	2.2 DTI, i	09.00-08.05	92/108				0 265 005 303		
Astra GTC [H]									
									
	1.4 Twinport	MFD	06.05-03.09	55/66	Fg.-Nr. →62999999, →65999999, →68999999	JBH,LLE, RLE	0 986 480 856	25,4	
					Fg.-Nr. 72000001→, 75000001→, 78000001→	LLE,RLE	0 986 481 059	25,4	

		S							
◀ VAUXHALL Astra GTC [H]									
1.4 Twinport	OFD	06.05-03.09	55/66	Fg.-Nr. →62999999, →65999999, →68999999	JBH,LLE	0986 480 880	25,4		
				Fg.-Nr. 72000001→, 75000001→, 78000001→	LLE	0986 481 058	25,4		
1.6	MFD	01.11-12.12	85			0986 481 059	25,4		
1.6, VVT	OFD	12.06-12.12	85		TW	0986 481 058	25,4		
1.6 Twinport	MFD	09.05-03.08	77	Fg.-Nr. →62999999, →65999999, →68999999	JBH,LLE, RLE	0986 480 856	25,4		
				Fg.-Nr. 72000001→, 75000001→, 78000001→	LLE,RLE	0986 481 059	25,4		
	OFD	09.05-03.08	77	Fg.-Nr. →62999999, →65999999, →68999999	JBH,LLE	0986 480 880	25,4		
				Fg.-Nr. 72000001→, 75000001→, 78000001→	LLE	0986 481 058	25,4		
1.6 VVT	MFD	12.06-12.12	85		JBH,TW TW	0986 480 856 0986 481 059	25,4 25,4		
	OFD	12.06-12.12	85		JBH,TW	0986 480 880	25,4		
1.7 CDTI	MFD	06.05-12.09	59/74/81/ 92	Fg.-Nr. →62999999, →65999999, →68999999	JBH,LLE, RLE	0986 480 856	25,4		
				Fg.-Nr. 72000001→, 75000001→, 78000001→	LLE,RLE	0986 481 059	25,4		
	OFD	06.05-12.09	59/74/81/ 92	Fg.-Nr. →62999999, →65999999, →68999999	JBH,LLE	0986 480 880	25,4		
				Fg.-Nr. 72000001→, 75000001→, 78000001→	LLE	0986 481 058	25,4		
1.8 i	MFD	06.05-02.09	92	Fg.-Nr. →62999999, →65999999, →68999999	JBH,LLE, RLE	0986 480 856	25,4		
				Fg.-Nr. 72000001→, 75000001→, 78000001→	LLE,RLE	0986 481 059	25,4		
	OFD	06.05-02.09	92	Fg.-Nr. →62999999, →65999999, →68999999	JBH,LLE	0986 480 880	25,4		
				Fg.-Nr. 72000001→, 75000001→, 78000001→	LLE	0986 481 058	25,4		
1.8 i VVT	MFD	01.11-12.12	103			0986 481 059	25,4		
	OFD	01.11-12.12	103		TW	0986 481 058	25,4		
2.0 Turbo	MFD	06.05-12.09	125/147/ 177	Fg.-Nr. →62999999, →65999999, →68999999	JBH,LLE, RLE	0986 480 856	25,4		
2.0 Turbo 16V				Fg.-Nr. 72000001→, 75000001→, 78000001→	LLE,RLE	0986 481 059	25,4		
	OFD	06.05-12.09	125/147/ 177	Fg.-Nr. →62999999, →65999999, →68999999	JBH,LLE	0986 480 880	25,4		
				Fg.-Nr. 72000001→, 75000001→, 78000001→	LLE	0986 481 058	25,4		
1.6, VVT		12.06-12.12	85		LLE	0986 486 068			
1.7 CDTI		03.07-12.09	81/92		LLE	0986 486 068			
1.8 i VVT		01.11-12.12	103		LLE	0986 486 068			
1.4 Twinport		06.05-03.09	55/66	Get.-Nr. F13	TW	0986 486 584	31		
				Get.-Nr. F13, Get.-Nr. F17	TW	0986 486 588	31		
				Get.-Nr. M20	EAY	0986 486 589	34		
					GS	0986 486 591	34		
1.6		01.11-12.12	85	Get.-Nr. F13	GS,TW	0986 486 584	31		
				Get.-Nr. F13, Get.-Nr. F17	EAY,GS,TW	0986 486 588	31		
				Get.-Nr. M20	EAY,TW	0986 486 589	34		
					GS,TW	0986 486 591	34		
1.6 Twinport		09.05-03.08	77	Get.-Nr. F13	TW	0986 486 584	31		
				Get.-Nr. F13, Get.-Nr. F17	TW	0986 486 588	31		
				Get.-Nr. M20	EAY	0986 486 589	34		
					GS	0986 486 591	34		

		S							
1.6 VVT		12.06-12.12	85	Get.-Nr. F13	MG5,TW	0 986 486 584	31		
				Get.-Nr. F13, Get.-Nr. F17	EAY, MG5, TW	0 986 486 588	31		
				Get.-Nr. M20	EAY	0 986 486 589	34		
					MG6	0 986 486 591	34		
1.7 CDTI		06.05-03.07	74	Get.-Nr. F13	TW	0 986 486 584	31		
				Get.-Nr. F13, Get.-Nr. F17	TW	0 986 486 588	31		
				Get.-Nr. M20	EAY	0 986 486 589	34		
				Get.-Nr. M20, Get.-Nr. M32	GS	0 986 486 591	34		
		09.05-03.07	59	Get.-Nr. F13	TW	0 986 486 584	31		
				Get.-Nr. F13, Get.-Nr. F17	TW	0 986 486 588	31		
				Get.-Nr. M20	EAY	0 986 486 589	34		
					GS	0 986 486 591	34		
		03.07-12.09	81/92	Get.-Nr. F13	TW	0 986 486 584	31		
				Get.-Nr. F13, Get.-Nr. F17	TW	0 986 486 588	31		
				Get.-Nr. M20	EAY	0 986 486 589	34		
					GS	0 986 486 591	34		
1.8 i		06.05-02.09	92	Get.-Nr. F13	TW	0 986 486 584	31		
				Get.-Nr. F13, Get.-Nr. F17	TW	0 986 486 588	31		
				Get.-Nr. M20	EAY	0 986 486 589	34		
					GS	0 986 486 591	34		
1.8 i VVT		01.11-12.12	103	Get.-Nr. F13	GS, TW	0 986 486 584	31		
				Get.-Nr. F13, Get.-Nr. F17	EAY, GS, TW	0 986 486 588	31		
				Get.-Nr. M20	EAY, TW	0 986 486 589	34		
					GS, TW	0 986 486 591	34		
1.9 CDTI		06.05-12.09	88/110	Get.-Nr. F13	TW	0 986 486 584	31		
				Get.-Nr. F13, Get.-Nr. F17	TW	0 986 486 588	31		
				Get.-Nr. M20	EAY	0 986 486 589	34		
					GS	0 986 486 591	34		
2.0 Turbo		06.05-12.09	125/147	Get.-Nr. F13	TW	0 986 486 584	31		
				Get.-Nr. F13, Get.-Nr. F17	TW	0 986 486 588	31		
				Get.-Nr. M20	EAY	0 986 486 589	34		
				Get.-Nr. M20, Get.-Nr. M32	GS	0 986 486 591	34		
2.0 Turbo 16V		06.05-03.09	177	Get.-Nr. F13	TW	0 986 486 584	31		
				Get.-Nr. F13, Get.-Nr. F17	TW	0 986 486 588	31		
				Get.-Nr. M20	EAY	0 986 486 589	34		
				Get.-Nr. M20, Get.-Nr. M32	GS	0 986 486 591	34		









Astra GTC [J]

	1.4 Turbo	09.11→	88/103	Get.-Nr. F17	TW	0 986 486 588	31		
		03.15→	88/103	Get.-Nr. F17	MG5, TW	0 986 486 588	31		
	1.6 Turbo	09.11→	132	Get.-Nr. F17	TW	0 986 486 588	31		
		09.13→	147	Get.-Nr. F17	MG5, TW	0 986 486 588	31		
	1.7	11.11→	81/96	Get.-Nr. F17	TW	0 986 486 588	31		
	2.0	09.11→	121	Get.-Nr. F17	TW	0 986 486 588	31		



Astra [H]

	1.2 Twinport	MFD	03.07-03.09	59	Fg.-Nr. →62999999,	JBH, LLE,	0 986 480 856	25,4		
					→65999999, →68999999	RLE	0 986 481 059	25,4		
		OFD	03.07-03.09	59	Fg.-Nr. 72000001→,	LLE, RLE	0 986 481 059	25,4		
					75000001→, 78000001→	JBH, LLE	0 986 480 880	25,4		
			Fg.-Nr. →62999999,	LLE	0 986 481 058	25,4				
			→65999999, →68999999							
			Fg.-Nr. 72000001→,							
			75000001→, 78000001→							

◀ VAUXHALL Astra [H]										
1.3 CDTI	MFD	01.06-03.10	66	Fg.-Nr. →62999999, →65999999, →68999999	JBH,LLE, RLE			0 986 480 856	25,4	
				Fg.-Nr. 72000001→, 75000001→, 78000001→	LLE,RLE			0 986 481 059	25,4	
	OFD	01.06-03.10	66	Fg.-Nr. →62999999, →65999999, →68999999	JBH,LLE			0 986 480 880	25,4	
				Fg.-Nr. 72000001→, 75000001→, 78000001→	LLE			0 986 481 058	25,4	
1.4 i 1.4 Twinport 1.4 Twinport Dualfuel	MFD	03.04-03.10	55/66	Fg.-Nr. →62999999, →65999999, →68999999	JBH,LLE, RLE			0 986 480 856	25,4	
				Fg.-Nr. 72000001→, 75000001→, 78000001→	LLE,RLE			0 986 481 059	25,4	
	OFD	03.04-03.10	55/66	Fg.-Nr. →62999999, →65999999, →68999999	JBH,LLE			0 986 480 880	25,4	
				Fg.-Nr. 72000001→, 75000001→, 78000001→	LLE			0 986 481 058	25,4	
1.6 1.6 Turbo		01.11-09.13	85/132		TW			0 986 481 058	25,4	
								0 986 481 059	25,4	
1.6 1.6 Turbo 1.6 Twinport	MFD	03.04-03.10	77/85/132	Fg.-Nr. →62999999, →65999999, →68999999	JBH,LLE, RLE			0 986 480 856	25,4	
				Fg.-Nr. 72000001→, 75000001→, 78000001→	LLE,RLE			0 986 481 059	25,4	
	OFD	03.04-03.10	77/85/132	Fg.-Nr. →62999999, →65999999, →68999999	JBH,LLE			0 986 480 880	25,4	
				Fg.-Nr. 72000001→, 75000001→, 78000001→	LLE			0 986 481 058	25,4	
1.7 CDTI		03.10-12.12	92		TW			0 986 481 058	25,4	
								0 986 481 059	25,4	
	MFD	03.04-03.10	59/74/81/ 92	Fg.-Nr. →62999999, →65999999, →68999999	JBH,LLE, RLE			0 986 480 856	25,4	
				Fg.-Nr. 72000001→, 75000001→, 78000001→	LLE,RLE			0 986 481 059	25,4	
	OFD	03.04-03.10	59/74/81/ 92	Fg.-Nr. →62999999, →65999999, →68999999	JBH,LLE			0 986 480 880	25,4	
				Fg.-Nr. 72000001→, 75000001→, 78000001→	LLE			0 986 481 058	25,4	
1.8 i		07.10-09.13	103		TW			0 986 481 058	25,4	
								0 986 481 059	25,4	
	MFD	03.04-03.10	92/103	Fg.-Nr. →62999999, →65999999, →68999999	JBH,LLE, RLE			0 986 480 856	25,4	
				Fg.-Nr. 72000001→, 75000001→, 78000001→	LLE,RLE			0 986 481 059	25,4	
	OFD	03.04-03.10	92/103	Fg.-Nr. →62999999, →65999999, →68999999	JBH,LLE			0 986 480 880	25,4	
				Fg.-Nr. 72000001→, 75000001→, 78000001→	LLE			0 986 481 058	25,4	
2.0 Turbo 2.0 Turbo 16V	MFD	03.04-03.10	125/147/ 177	Fg.-Nr. →62999999, →65999999, →68999999	JBH,LLE, RLE			0 986 480 856	25,4	
				Fg.-Nr. 72000001→, 75000001→, 78000001→	LLE,RLE			0 986 481 059	25,4	
	OFD	03.04-03.10	125/147/ 177	Fg.-Nr. →62999999, →65999999, →68999999	JBH,LLE			0 986 480 880	25,4	
				Fg.-Nr. 72000001→, LLE 75000001→, 78000001→			0 986 481 058	25,4		
	1.2 Twinport	03.07-03.09	59		LLE			0 986 486 068		
	1.6	03.07-03.10	85		LLE			0 986 486 068		
		01.11-09.13	85		LLE			0 986 486 068		
	1.6 Turbo	03.07-03.10	132		LLE			0 986 486 068		
		01.11-09.13	132		LLE			0 986 486 068		
	1.6 Twinport	03.07-03.09	77		LLE			0 986 486 068		
	1.7 CDTI	03.10-12.12	92		LLE			0 986 486 068		

		S							
1.8 i		08.05-03.10	103			LLE	0 986 486 068		
		07.10-09.13	103			LLE	0 986 486 068		
1.9 CDTI		09.05-03.10	74/88			LLE	0 986 486 068		
 1.2 Twinport		03.07-03.09	59	Get.-Nr. M 20→		EAY	0 986 486 589	34	
1.3 CDTI		01.06-03.10	66	Get.-Nr. F13		TW	0 986 486 584	31	
				Get.-Nr. F13, Get.-Nr. F17		TW	0 986 486 588	31	
				Get.-Nr. M20		EAY	0 986 486 589	34	
				Get.-Nr. M20, Get.-Nr. M32		GS	0 986 486 591	34	
1.4 i		03.04-03.10	55/66	Get.-Nr. F13		TW	0 986 486 584	31	
1.4 Twinport				Get.-Nr. F13, Get.-Nr. F17		TW	0 986 486 588	31	
1.4 Twinport Dualfuel				Get.-Nr. M20		EAY	0 986 486 589	34	
						GS	0 986 486 591	34	
1.6		03.07-03.10	85	Get.-Nr. F13		TW	0 986 486 584	31	
				Get.-Nr. F13, Get.-Nr. F17		TW	0 986 486 588	31	
				Get.-Nr. M20		EAY	0 986 486 589	34	
						GS	0 986 486 591	34	
		01.11-09.13	85	Get.-Nr. F13		GS,TW	0 986 486 584	31	
				Get.-Nr. F13, Get.-Nr. F17		EAY,GS,TW	0 986 486 588	31	
				Get.-Nr. M20		EAY	0 986 486 589	34	
						MG6	0 986 486 591	34	
1.6 Turbo		03.07-03.10	132	Get.-Nr. F13		TW	0 986 486 584	31	
				Get.-Nr. F13, Get.-Nr. F17		TW	0 986 486 588	31	
				Get.-Nr. M20		EAY	0 986 486 589	34	
				Get.-Nr. M20, Get.-Nr. M32		GS	0 986 486 591	34	
		01.11-09.13	132	Get.-Nr. F13		GS,TW	0 986 486 584	31	
				Get.-Nr. F13, Get.-Nr. F17		EAY,GS,TW	0 986 486 588	31	
				Get.-Nr. M20		EAY	0 986 486 589	34	
				Get.-Nr. M20, Get.-Nr. M32		GS	0 986 486 591	34	
1.6 Twinport		03.04-03.07	77			EAY	0 986 486 588	31	
						EAY	0 986 486 594	34	
		03.07-03.09	77	Get.-Nr. F13		TW	0 986 486 584	31	
				Get.-Nr. F13, Get.-Nr. F17		TW	0 986 486 588	31	
				Get.-Nr. M20		EAY	0 986 486 589	34	
						GS	0 986 486 591	34	
1.7 CDTI		03.04-09.09	59/74/81			EAY	0 986 486 588	31	
						EAY	0 986 486 594	34	
		05.07-03.10	92			EAY	0 986 486 588	31	
						EAY	0 986 486 594	34	
		03.10-12.12	92	Get.-Nr. F13		MG5,TW	0 986 486 584	31	
				Get.-Nr. F13, Get.-Nr. F17		EAY,MG5,TW	0 986 486 588	31	
				Get.-Nr. M20		EAY	0 986 486 589	34	
						MG6,TW	0 986 486 591	34	
				Get.-Nr. M32		MG6,TW	0 986 486 594	34	
1.8 i		03.04-02.09	92			EAY	0 986 486 588	31	
						EAY	0 986 486 594	34	
		08.05-03.10	103	Get.-Nr. F13		TW	0 986 486 584	31	
				Get.-Nr. F13, Get.-Nr. F17		TW	0 986 486 588	31	
				Get.-Nr. M20		EAY	0 986 486 589	34	
						GS	0 986 486 591	34	
		07.10-09.13	103	Get.-Nr. F13		GS,TW	0 986 486 584	31	
				Get.-Nr. F13, Get.-Nr. F17		EAY,GS,TW	0 986 486 588	31	
				Get.-Nr. M20		EAY	0 986 486 589	34	
						GS,TW	0 986 486 591	34	
1.9 CDTI		03.04-03.10	74/88/110				0 986 486 590	34	
2.0 Turbo		03.05-03.10	177				0 986 486 588	31	















Astra [J]

									
 1.3 CDTI		09.09→	70	Get.-Nr. F17		TW	0 986 486 588	31	
1.4 i		09.09→	64/74/88/	Get.-Nr. F17		TW	0 986 486 588	31	
1.4 Turbo			103						























		S							
VAUXHALL Astra [J]									
	1.6 CDTI, GTC, i, i Turbo	09.09→	81/85/100/132	Get.-Nr. F17	TW	0986 486 588	31		
	1.7 CDTI	09.09→	81/92/96	Get.-Nr. F17	TW	0986 486 588	31		
	2.0 CDTI, GTC, GTC Turbo	09.09→	118/121/143/206	Get.-Nr. F17	TW	0986 486 588	31		
Astra Sport Tourer									
	1.7 CDTI	01.12→	96	Get.-Nr. F17	TW	0986 486 588	31		
Astra Sports Tourer									
	1.7 CDTI	01.12→	81/96	Get.-Nr. F17	TW	0986 486 588	31		
Astra Sports Tourer [J]									
	1.3 CDTI	09.10→	70	Get.-Nr. F17	TW	0986 486 588	31		
	1.4 i	09.10→	74	Get.-Nr. F17	TW	0986 486 588	31		
		03.15→	74	Get.-Nr. F17	MG5,TW	0986 486 588	31		
	1.4 i Turbo	09.10→	103	Get.-Nr. F17	TW	0986 486 588	31		
	1.6 CDTI	10.13→	81	Get.-Nr. F17	TW	0986 486 588	31		
			100	Get.-Nr. F17	TW	0986 486 588	31		
	1.6 i	09.10→	85	Get.-Nr. F17	TW	0986 486 588	31		
		03.15→	85	Get.-Nr. F17	MG5,TW	0986 486 588	31		
	1.7 CDTI	09.10→	81/92	Get.-Nr. F17	TW	0986 486 588	31		
	2.0 CDTI	09.10→	118/121/143	Get.-Nr. F17	TW	0986 486 588	31		
Astra TwinTop [H]									
	1.6 i	MFD 09.05-12.09	76-77/85/132	Fg.-Nr. →62999999, →65999999, →68999999	JBH,LLE, RLE	0986 480 856	25,4		
	1.6 i Turbo			Fg.-Nr. 72000001→, 75000001→, 78000001→	LLE,RLE	0986 481 059	25,4		
		OFD 09.05-12.09	76-77/85/132	Fg.-Nr. →62999999, →65999999, →68999999	JBH,LLE	0986 480 880	25,4		
				Fg.-Nr. 72000001→, 75000001→, 78000001→	LLE	0986 481 058	25,4		
	1.8 i	MFD 03.06-03.09	103	Fg.-Nr. →62999999, →65999999, →68999999	JBH,LLE, RLE	0986 480 856	25,4		
				Fg.-Nr. 72000001→, 75000001→, 78000001→	LLE,RLE	0986 481 059	25,4		
		OFD 03.06-03.09	103	Fg.-Nr. →62999999, →65999999, →68999999	JBH,LLE	0986 480 880	25,4		
				Fg.-Nr. 72000001→, 75000001→, 78000001→	LLE	0986 481 058	25,4		
	2.0 i Turbo	MFD 09.05-12.09	125/147	Fg.-Nr. →62999999, →65999999, →68999999	JBH,LLE, RLE	0986 480 856	25,4		
				Fg.-Nr. 72000001→, 75000001→, 78000001→	LLE,RLE	0986 481 059	25,4		
		OFD 09.05-12.09	125/147	Fg.-Nr. →62999999, →65999999, →68999999	JBH,LLE	0986 480 880	25,4		
				Fg.-Nr. 72000001→, 75000001→, 78000001→	LLE	0986 481 058	25,4		















		S							
	1.6 i, i Turbo	09.05-12.09	76-77/85/132			LLE	0 986 486 068		
	1.8 i	03.06-03.09	103			LLE	0 986 486 068		
	1.9 CDTi	09.05-12.09	110			LLE	0 986 486 068		
	2.0 i Turbo	09.05-12.09	125/147			LLE	0 986 486 068		
	1.6 i	09.05-12.09	76-77/85	Get.-Nr. F13		TW	0 986 486 584	31	
				Get.-Nr. F13, Get.-Nr. F17		TW	0 986 486 588	31	
				Get.-Nr. M20		EAY	0 986 486 589	34	
						GS	0 986 486 591	34	
	1.6 i Turbo	03.07-12.09	132	Get.-Nr. F13		TW	0 986 486 584	31	
				Get.-Nr. F13, Get.-Nr. F17		TW	0 986 486 588	31	
				Get.-Nr. M20		EAY	0 986 486 589	34	
				Get.-Nr. M20, Get.-Nr. M32		GS	0 986 486 591	34	
	1.8 i	03.06-03.09	103	Get.-Nr. F13		TW	0 986 486 584	31	
				Get.-Nr. F13, Get.-Nr. F17		TW	0 986 486 588	31	
				Get.-Nr. M20		EAY	0 986 486 589	34	
						GS	0 986 486 591	34	
	1.9 CDTi	09.05-12.09	110	Get.-Nr. F13		TW	0 986 486 584	31	
				Get.-Nr. F13, Get.-Nr. F17		TW	0 986 486 588	31	
				Get.-Nr. M20		EAY	0 986 486 589	34	
						GS	0 986 486 591	34	
				Get.-Nr. M32			0 986 486 590	34	
	2.0 i Turbo	09.05-12.09	125/147	Get.-Nr. F13		TW	0 986 486 584	31	
				Get.-Nr. F13, Get.-Nr. F17		TW	0 986 486 588	31	
				Get.-Nr. M20		EAY	0 986 486 589	34	
				Get.-Nr. M20, Get.-Nr. M32		GS	0 986 486 591	34	
Astra Van [F]									
									
	1.4 i	09.90-02.98	44			DEL,JBH	0 986 480 130	20,6	
						DEL,JBH,VEA	0 986 480 132	22,2	
		ABS 09.90-02.98	44			DEL,JBH	0 986 480 129	22,2	
						JBH ATE	0 986 480 907	22	
	1.6 i	09.91-02.98	52/55			DEL,JBH	0 986 480 130	20,6	
						DEL,JBH,VEA	0 986 480 132	22,2	
		ABS 09.91-02.98	52/55			DEL,JBH	0 986 480 129	22,2	
						JBH ATE	0 986 480 907	22	
	1.7 D/DR	12.91-02.98	42-44			DEL,JBH	0 986 480 130	20,6	
						JBH,VEA ATE	0 986 480 752	22,2	
	1.7 D/DR	ABS 12.91-02.98	42-44/50			DEL,JBH	0 986 480 129	22,2	
	1.7 DTL					JBH ATE	0 986 480 907	22	
	1.7 DTL	07.95-02.98	50			DEL,JBH	0 986 480 130	20,6	
						DEL,JBH,VEA	0 986 480 132	22,2	
	1.4 i	09.90-02.98	44				0 265 208 311 ^H		
	1.6 i	09.91-02.98	52/55				0 265 208 311 ^H		
	1.7 D/DR, DTL	12.91-02.98	42-44/50				0 265 208 311 ^H		
Astra Van [G]									
									
	1.6 i	MFD 09.97-08.05	55/62			JBH	0 986 481 028	23,81	
		OFD 09.97-08.05	55/62			JBH	0 986 480 699	23,8	
	1.7 CDTi	MFD 03.03-08.05	59			JBH	0 986 481 028	23,81	
		OFD 03.03-08.05	59			4SB,JBH	0 986 480 699	23,8	
	1.7 DT	MFD 03.98-08.00	50			JBH	0 986 481 028	23,81	
		OFD 03.98-08.00	50			JBH	0 986 480 699	23,8	
	2.0 DTi	MFD 03.98-08.05	60/74			JBH	0 986 481 028	23,81	
	2.0 DTL	OFD 03.98-08.05	60/74			JBH	0 986 480 699	23,8	

◀ VAUXHALL Astra Van [G]									
	1.6 i	09.97-08.05	55/62		LLE	0 986 486 068			
	1.7 DT	03.98-08.00	50		LLE	0 986 486 068			
	2.0 DTI, DTL	03.98-08.05	60/74		LLE	0 986 486 068			
	1.6 i	09.97-08.05	55/62		F13	0 986 486 588	31		
					F23	0 986 486 586	34		
	1.7 CDTI	03.03-08.05	59		F13	0 986 486 588	31		
	1.7 DT	03.98-08.00	50		F13	0 986 486 588	31		
					F23	0 986 486 586	34		
	2.0 DTI	03.98-08.05	60/74		F18	0 986 486 593	34		
	2.0 DTL				F23	0 986 486 586	34		
	1.6 i	09.97-08.05	55	Fg.-Nr. →X2014819, →X5009355, →X6006066		0 265 216 474 ^B			
				Fg.-Nr. →X8005679		0 265 216 474 ^B			
		09.00-08.05	62	Fg.-Nr. →12999999, →15999999, →16999999, →18999999, →1B999999		0 265 220 585 ^B			
				Fg.-Nr. →32035797, →35033917, →38004448		0 265 202 492 ^T			
				Fg.-Nr. 22000001→, 25000001→, 26000001→, 28000001→		0 265 220 637 ^F			
				Fg.-Nr. 32035798→, 35033918→, 38004449→		0 265 202 509 ^T			
		OFD 09.97-08.05	55	Fg.-Nr. X2014820→, X5009356→, X6006067→, X8005680→		0 265 216 652 ^B			
			09.00-08.05	62		0 265 216 652 ^B			
		1.7 CDTI	03.03-08.05	59		0 265 216 652 ^B			
					Fg.-Nr. 22000001→, 25000001→, 26000001→, 28000001→		0 265 220 637 ^F		
		1.7 DT	03.98-08.00	50	Fg.-Nr. →X2014819, →X5009355, →X6006066		0 265 216 474 ^B		
					Fg.-Nr. →X8005679		0 265 216 474 ^B		
		OFD 03.98-08.00	50	Fg.-Nr. X2014820→, X5009356→, X6006067→, X8005680→		0 265 216 652 ^B			
		2.0 DTI	09.00-08.05	74	Fg.-Nr. →12999999, →15999999, →16999999, →18999999, →1B999999		0 265 220 585 ^B		
				Fg.-Nr. →32035797, →35033917, →38004448		0 265 202 492 ^T			
				Fg.-Nr. 22000001→, 25000001→, 26000001→, 28000001→		0 265 220 637 ^F			
				Fg.-Nr. 32035798→, 35033918→, 38004449→		0 265 202 509 ^T			
	OFD 09.00-08.05	74			0 265 216 652 ^B				
	2.0 DTL	03.98-08.00	60	Fg.-Nr. →X2014819, →X5009355, →X6006066		0 265 216 474 ^B			
				Fg.-Nr. →X8005679		0 265 216 474 ^B			
				Fg.-Nr. →32035797, →35033917, →38004448		0 265 202 492 ^T			
				Fg.-Nr. 32035798→, 35033918→, 38004449→		0 265 202 509 ^T			
	OFD 03.98-08.00	60	Fg.-Nr. X2014820→, X5009356→, X6006067→, X8005680→		0 265 216 652 ^B				
	1.6 i	09.00-08.05	62			0 265 005 262			
	2.0 DTI	09.00-08.05	74			0 265 005 262			
	2.0 DTL	03.98-08.00	60	Fg.-Nr. →12999999, →1H999999		0 265 005 262			
	1.6 i	09.00-08.05	62			0 265 005 435			
	2.0 DTI	09.00-08.05	74			0 265 005 435			
	2.0 DTL	03.98-08.00	60	Fg.-Nr. 22000001→, 2H000001→		0 265 005 435			

									
	1.6 i	09.00-08.05	62						0 265 005 303
	2.0 DTI, DTL	03.98-08.05	60/74						0 265 005 303
Calibra									
									
	2.0 i	03.90-03.98	83-85/100/ 110			DEL, JBH			0 986 480 129
						JBH	ATE		0 986 480 907
	2.0 i turbo	03.92-07.97	150			JBH	ATE		0 986 480 758
	2.5 i V6	04.93-03.97	125			JBH, LLE	ATE		0 986 480 758
	2.0 i	ABO 03.90-03.98	83-85/100/110			RLE	ATE		0 986 485 109
	2.0 i turbo	03.92-07.97	150			RLE	ATE		0 986 485 109
	2.5 i V6	04.93-03.97	125			RLE	ATE		0 986 485 109
	2.0 i	03.90-03.98	83-85/100/	Fg.-Nr. L1000001→		AA			0 265 201 048^H
	2.0 i turbo		110/150	M12999999					0 265 208 311^H
				Fg.-Nr. L1000001→T1001897					0 265 208 311^H
	2.5 i V6	04.93-03.97	125	Fg.-Nr. L1000001→		AA			0 265 201 048^H
				M12999999					0 265 208 311^H
				Fg.-Nr. N1000001→T1001897					0 265 208 311^H
	2.0 i	03.90-03.98	83-85/110/	Fg.-Nr. L1000001→		NAA			0 265 103 038^H
	2.0 i turbo		150	M12999999					
Carlton III									
									
	1.8	09.86-10.94	65-66/85			LLE	ATE		0 986 480 750
	1.8 i	ABO 09.86-10.94	65-66/85			JBH, RLE			0 986 480 644
		ABS 09.86-10.94	65-66/85			JBH, LLE			0 986 480 892
						JBH, RLE			0 986 480 643
	2.0 i	09.86-10.94	73-74/85/90			JBH, LLE	ATE		0 986 480 751
		ABO 09.86-10.94	73-74/85/90			JBH, RLE			0 986 480 644
		ABS 09.86-10.94	73-74/85/ 90			JBH, LLE			0 986 480 892
						JBH, RLE			0 986 480 643
	2.3 D	09.86-10.94	54/74			LLE	ATE		0 986 480 750
	2.3 TD Interc.	ABO 09.86-10.94	54/74			JBH, RLE			0 986 480 644
		ABS 09.86-10.94	54/74			JBH, LLE			0 986 480 892
						JBH, RLE			0 986 480 643
	2.4 i	09.86-10.94	92			JBH, LLE	ATE		0 986 480 751
		ABO 09.86-10.94	92			JBH, RLE			0 986 480 644
		ABS 09.86-10.94	92			JBH, LLE			0 986 480 892
						JBH, RLE			0 986 480 643
	2.6 i	ABS 09.90-10.94	110			LLE	ATE		0 986 480 756
	3.0 i	ABS 03.87-10.94	130/147-150			LLE	ATE		0 986 480 756
	1.8, i	09.86-10.94	65-66/85			V02	ATE		0 986 485 100
	2.0 i	09.86-10.94	73-74/85/90			V02	ATE		0 986 485 100
	2.3 D, TD Interc.	09.86-10.94	54/74			V02	ATE		0 986 485 100
	2.4 i	09.86-10.94	92			V02	ATE		0 986 485 100
	3.0 i	03.87-10.94	130/147-150			V02	ATE		0 986 485 100
	1.8, i	09.86-10.94	65-66/85						0 265 200 041^H
	2.0 i	09.86-10.94	73-74/85/90						0 265 200 041^H
	2.3 D, TD Interc.	09.86-10.94	54/74						0 265 200 041^H
	2.4 i	09.86-10.94	92						0 265 200 041^H
	1.8	09.86-10.94	65-66/85	Fg.-Nr. →K1000098					0 265 103 016^H
	1.8 i			Fg.-Nr. K1000099→					0 265 103 034^H
	2.0 i	09.86-10.94	73-74/85/ 90	Fg.-Nr. →K1000098 Fg.-Nr. K1000099→					0 265 103 016^H 0 265 103 034^H



		S											
VAUXHALL Carlton III													
2.3 D		09.86-10.94	54/74		Fg.-Nr. →K1000098		0 265 103 016 ^H						
2.3 TD Interc.					Fg.-Nr. K1000099→		0 265 103 034 ^H						
2.4 i		09.86-10.94	92		Fg.-Nr. →K1000098		0 265 103 016 ^H						
					Fg.-Nr. K1000099→		0 265 103 034 ^H						
2.6 i		09.90-10.94	110		Fg.-Nr. →K1000098		0 265 103 016 ^H						
					Fg.-Nr. K1000099→		0 265 103 034 ^H						
3.0 i		03.87-10.94	130/ 147-150		Fg.-Nr. →K1000098		0 265 103 016 ^H						
					Fg.-Nr. K1000099→		0 265 103 034 ^H						
Cavalier III													
	1.4	ABO	09.88-11.95	55		DEL,JBH	0 986 480 114	20,64					
		ABS	09.88-11.95	55		DEL,JBH	0 986 480 129	22,2					
						JBH ATE	0 986 480 907	22					
	1.6 i	ABO	09.94-08.95	55	Fg.-Nr. P1000001→ R7999999	DEL,JBH	0 986 480 130	20,6					
					Fg.-Nr. S1000001→	DEL,JBH	0 986 480 132	22,2					
				09.94-11.95	52	Fg.-Nr. →N5999999	DEL,JBH	0 986 480 114	20,64				
						Fg.-Nr. P1000001→	DEL,JBH	0 986 480 130	20,6				
	1.6 i KAT	ABO	09.88-11.95	55-60	Fg.-Nr. →N5999999	DEL,JBH	0 986 480 114	20,64					
	1.6 S				Fg.-Nr. P1000001→	DEL,JBH	0 986 480 130	20,6					
	1.6 i, i KAT, S	ABS	09.88-11.95	52/55-60		DEL,JBH	0 986 480 129	22,2					
						JBH ATE	0 986 480 907	22					
	1.7 D	ABO	09.88-11.95	42/60	Fg.-Nr. →N5999999	DEL,JBH	0 986 480 114	20,64					
	1.7 TD	ABS	09.88-11.95	42/60	Fg.-Nr. P1000001→ R7999999	DEL,JBH	0 986 480 130	20,6					
						Fg.-Nr. S1000001→	DEL,JBH	0 986 480 132	22,2				
							DEL,JBH	0 986 480 129	22,2				
							JBH ATE	0 986 480 907	22				
	1.8	ABO	09.88-11.95	65/66	Fg.-Nr. →N5999999	DEL,JBH	0 986 480 114	20,64					
	1.8 i				Fg.-Nr. P1000001→	DEL,JBH	0 986 480 130	20,6					
						Fg.-Nr. S1000001→	DEL,JBH	0 986 480 132	22,2				
							DEL,JBH	0 986 480 129	22,2				
		ABS	09.88-11.95	65/66		JBH ATE	0 986 480 907	22					
	2.0 i	ABO	09.88-08.95	95		DEL	0 986 480 115	22,22					
						JBH ATE	0 986 480 752	22,2					
							09.88-11.95	85/86		JBH ATE	0 986 480 752	22,2	
								Fg.-Nr. →N5999999	DEL	0 986 480 115	22,22		
					Fg.-Nr. P1000001→	DEL,JBH	0 986 480 131	22,2					
	2.0 i, i 4x4, i 16V, i 16V 4x4	ABS	09.88-11.95	85/86/95/ 100/110		DEL,JBH	0 986 480 129	22,2					
						JBH ATE	0 986 480 907	22					
	2.0 i 4x4		09.92-08.95	150		JBH ATE	0 986 480 758	23,8					
			ABO	09.88-08.95	95		JBH ATE	0 986 480 752	22,2				
	2.0 i 16V	ABO	09.88-11.95	110	Fg.-Nr. →N5999999	DEL	0 986 480 115	22,22					
						Fg.-Nr. P1000001→	DEL,JBH	0 986 480 131	22,2				
						09.93-11.95	100		AA,DEL,JBH	0 986 480 132	22,2		
									AA,DEL,JBH	0 986 480 131	22,2		
	2.0 i 16V, i 16V 4x4	ABO	09.88-11.95	110		JBH ATE	0 986 480 752	22,2					
	2.0 i 16V 4x4	ABO	09.88-11.95	110		DEL,JBH	0 986 480 132	22,2					
						Fg.-Nr. P1000001→	DEL,JBH	0 986 480 131	22,2				
							JBH, LLE ATE	0 986 480 758	23,8				
	1.4	ABS	09.88-11.95	55		RLE ATE	0 986 485 109						
	1.6 i, i KAT, S	ABS	09.88-11.95	52/55-60		RLE ATE	0 986 485 109						
	1.7 D, TD	ABS	09.88-11.95	42/60		RLE ATE	0 986 485 109						
	1.8, i, S	ABS	09.88-11.95	65/66		RLE ATE	0 986 485 109						
	2.0 i		09.88-11.95	85/86		RLE ATE	0 986 485 109						
				ABS	09.88-08.95	95		RLE ATE	0 986 485 109				
					09.88-08.95	95		AA,RLE ATE	0 986 485 109				
			09.92-08.95	150		AA,RLE ATE	0 986 485 109						

		S							
2.0 i 16V		09.88-11.95	110			RLE	ATE	0 986 485 109	
		09.93-11.95	100			RLE	ATE	0 986 485 109	
2.0 i 16V 4x4		09.88-11.95	110			AA,RLE	ATE	0 986 485 109	
2.5 i V6		02.93-11.95	125			RLE	ATE	0 986 485 109	
 1.4		09.88-11.95	55			Fg.-Nr. →MV999999, →M1999999, →N5000039		0 265 201 048 ^H	
						Fg.-Nr. NV000001→, N1000001→, N5000040→		0 265 208 311 ^H	
1.6 i, i KAT, S		09.88-11.95	52/55-60			Fg.-Nr. →MV999999, →M1999999, →N5000039		0 265 201 048 ^H	
						Fg.-Nr. NV000001→, N1000001→, N5000040→		0 265 208 311 ^H	
1.7 D		09.88-11.95	42/60			Fg.-Nr. →MV999999, →M1999999, →N5000039		0 265 201 048 ^H	
1.7 TD						Fg.-Nr. NV000001→, N1000001→, N5000040→		0 265 208 311 ^H	
1.8, i, S		09.88-11.95	65/66			Fg.-Nr. →MV999999, →M1999999, →N5000039		0 265 201 048 ^H	
						Fg.-Nr. NV000001→, N1000001→, N5000040→		0 265 208 311 ^H	
2.0 i, i 4x4, i 16V, i 16V 4x4		09.88-11.95	85/86/95/ 100/110/ 150			Fg.-Nr. →MV999999, →M1999999, →N5000039		0 265 201 048 ^H	
						Fg.-Nr. NV000001→, N1000001→, N5000040→		0 265 208 311 ^H	
2.5 i V6		02.93-11.95	125			Fg.-Nr. →MV999999, →M1999999, →N5000039		0 265 201 048 ^H	
						Fg.-Nr. NV000001→, N1000001→, N5000040→		0 265 208 311 ^H	
 CPU 1.4		09.88-11.95	55			Fg.-Nr. →MV235527, →L1999999, →L5999999		0 265 100 039 ^H	
						Fg.-Nr. MV235528→MV999999, M1000001→M1999999, M5000001→M5000039		0 265 103 038 ^H	
1.6 i		09.88-11.95	52/55-60			Fg.-Nr. →MV235527, →L1999999, →L5999999		0 265 100 039 ^H	
1.6 i KAT						Fg.-Nr. MV235528→MV999999, M1000001→M1999999, M5000001→M5000039		0 265 103 038 ^H	
1.6 S						Fg.-Nr. →MV235527, →L1999999, →L5999999		0 265 100 039 ^H	
1.7 D		09.88-11.95	42/60			Fg.-Nr. →MV235527, →L1999999, →L5999999		0 265 100 039 ^H	
1.7 TD						Fg.-Nr. MV235528→MV999999, M1000001→M1999999, M5000001→M5000039		0 265 103 038 ^H	
1.8		09.88-11.95	65/66			Fg.-Nr. →MV235527, →L1999999, →L5999999		0 265 100 039 ^H	
1.8 i						Fg.-Nr. MV235528→MV999999, M1000001→M1999999, M5000001→M5000039		0 265 103 038 ^H	
1.8 S						Fg.-Nr. →MV235527, →L1999999, →L5999999		0 265 100 039 ^H	
2.0 i		09.88-11.95	85/86/95/ 100/110			Fg.-Nr. →MV235527, →L1999999, →L5999999		0 265 100 039 ^H	
2.0 i 16V						Fg.-Nr. MV235528→MV999999, M1000001→M1999999, M5000001→M5000039		0 265 103 038 ^H	
Combo									
									
 1.2 i	ABO	09.94-10.01	33			JBH,LLE		0 986 480 130	20,6
	ABS	09.94-10.01	33			JBH,LLE		0 986 480 818	22

			S								
VAUXHALL Combo											
	1.4 i	A	09.94-10.01	44/60/66			JBH,LLE	0 986 480 130	20,6		
		ABS	09.94-10.01	44/60/66			JBH,LLE	0 986 480 818	22		
	1.7 D	A	09.94-10.01	44			JBH,LLE	0 986 480 130	20,6		
		ABS	09.94-10.01	44			JBH,LLE	0 986 480 818	22		
	1.2 i		09.94-10.01	33	Fg.-Nr. T3000001→		BO	0 265 216 410 ^B			
	1.4 i		09.94-10.01	44/60/66	Fg.-Nr. T3000001→		BO	0 265 216 410 ^B			
	1.7 D		09.94-10.01	44	Fg.-Nr. T3000001→		BO	0 265 216 410 ^B			
Combo [Tour]											
	1.3 CDTi	A	09.04-01.12	51			TW	0 204 123 659	22,2		
								0 204 123 662	22,2		
							4SB,TW	0 204 123 662	22,2		
			03.06-01.12	55			TW	0 204 123 659	22,2		
							4SB,TW	0 204 123 662	22,2		
			MFD	09.04-01.12	51/55		STB	0 204 123 639	22,2		
	1.4 i Twinport	1.4 i Twinport Dualfuel						4SB	0 204 123 637	23,8	
				09.04-01.12	51/55			STB	0 204 123 640	22,2	
								4SB	F 026 003 638	23,81	
	1.4 i Twinport	1.4 i Twinport Dualfuel	A	01.04-01.12	65/66			TW	0 204 123 659	22,2	
								4SB,TW	0 204 123 662	22,2	
				MFD	01.04-01.12	65/66		STB	0 204 123 639	22,2	
	1.6 CNG	1.6 i						4SB	0 204 123 637	23,8	
				01.04-01.12	65/66			STB	0 204 123 640	22,2	
								4SB	F 026 003 638	23,81	
1.6 CNG	1.6 i	A	04.05-05.06	71	Fg.-Nr. 43000001→		STB	0 204 123 659	22,2		
					Fg.-Nr. 44000001→, 46000001→			0 204 123 659	22,2		
			06.06-01.12	69			TW	0 204 123 659	22,2		
1.7 CDTi	1.7 DI, DTI							0 204 123 662	22,2		
			04.05-05.06	71	Fg.-Nr. 43000001→, 44000001→, 46000001→			F 026 003 638	23,81		
								F 026 003 638	23,81		
1.7 CDTi	1.7 DI, DTI		10.01-08.04	64			DEL,JBH	0 986 480 859	22		
			09.04-01.12	74			TW	0 204 123 659	22,2		
								0 204 123 662	22,2		
1.7 CDTi	1.7 DI, DTI		09.04-01.12	74			STB	0 204 123 639	22,2		
							4SB	0 204 123 637	23,8		
			09.04-01.12	74			STB	0 204 123 640	22,2		
1.7 CDTi	1.7 DI, DTI						4SB	F 026 003 638	23,81		
			09.01-08.04	48/55			DEL,JBH	0 986 480 859	22		
	1.3 CDTi		09.04-01.12	51			4SB,TW	0 204 125 812			
								0 204 777 301			
			03.06-01.12	55			4SB,TW	0 204 125 812			
	1.4 i Twinport	1.4 i Twinport Dualfuel							0 204 777 301		
				09.04-01.12	51			STB	0 204 125 812		
									0 204 125 812		
	1.4 i Twinport	1.4 i Twinport Dualfuel		03.06-01.12	55			STB	0 204 125 812		
				09.04-01.12	51/55			STB,TW	0 204 125 813		
									0 204 777 297		
	1.4 i Twinport	1.4 i Twinport Dualfuel		01.04-01.12	66			4SB,TW	0 204 125 812		
									0 204 777 301		
				A	01.04-01.12	66		STB	0 204 125 812		
1.4 i Twinport	1.4 i Twinport Dualfuel		09.04-01.12	65			4SB,TW	0 204 125 812			
								0 204 777 301			
			A	09.04-01.12	65		STB	0 204 125 812			
1.4 i Twinport	1.4 i Twinport Dualfuel		01.04-01.12	65/66			STB,TW	0 204 125 813			
								0 204 777 297			
1.6 CNG	1.6 i		06.06-01.12	69				0 204 125 812			
								0 204 777 301			

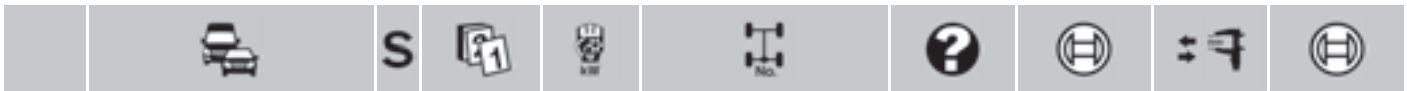

	1.7 CDTi	09.04-01.12	74		4SB	0 204 125 812	
	ABO	09.04-01.12	74		STB	0 204 125 812	
	ABS	09.04-01.12	74		STB	0 204 125 813	

	1.3 CDTi	09.04-01.12	51/55			0 986 486 588	31
	1.4 i Twinport	01.04-01.12	65/66		EAY	0 986 486 588	31
	1.4 i Twinport Dualfuel				GS	0 986 486 584	31
	1.6 CNG	04.05-01.12	69/71			0 986 486 588	31
	1.6 i	10.01-08.04	64			0 986 486 588	31
	1.7 Di, DTI	09.01-08.04	48/55			0 986 486 588	31

	1.3 CDTi	09.04-01.12	51			0 265 232 213 ^B	
		03.06-01.12	55			0 265 232 213 ^B	
	1.4 i Twinport	01.04-01.12	65/66			0 265 234 340 ^T	
	1.4 i Twinport Dualfuel			Fg.-Nr. 53000001→, 54000001→, 56000001→	GS	0 265 232 213 ^B	
	1.6 CNG	06.06-01.12	69			0 265 232 213 ^B	
	1.7 CDTi	09.04-01.12	74			0 265 234 340 ^T	
				Fg.-Nr. 54000001→, 56000001→		0 265 232 215 ^B	

	1.6 CNG	04.05-01.12	69/71			0 265 005 303	
--	---------	-------------	-------	--	--	---------------	--

Corsa [B]

	1.0 i	ABO	09.96-09.00	40		JBH, LLE	0 986 480 130	20,6
		ABS	09.96-09.00	40		JBH, LLE	0 986 480 818	22
	1.2 i	ABO	09.94-08.00	33/48		JBH, LLE	0 986 480 130	20,6
		ABS	09.94-08.00	33/48		JBH, LLE	0 986 480 818	22
	1.4 i	ABO	09.94-08.00	44/60/63/66		JBH, LLE	0 986 480 130	20,6
		ABS	09.94-08.00	44/60/63/66		JBH, LLE	0 986 480 818	22
	1.5 D, TD, XTD	ABO	09.94-08.00	37/49		JBH, LLE	0 986 480 130	20,6
		ABS	09.94-08.00	37/49		JBH, LLE	0 986 480 818	22
	1.6 GSI	ABO	09.94-08.00	74/78/80		JBH, LLE	0 986 480 130	20,6
	1.6 i	ABS	09.94-08.00	74/78/80		JBH, LLE	0 986 480 818	22
	1.7 D	ABO	09.94-08.00	44		JBH, LLE	0 986 480 130	20,6
		ABS	09.94-08.00	44		JBH, LLE	0 986 480 818	22













	1.0 i		09.96-09.00	40	Fg.-Nr. T3000001→	BO	0 265 216 410 ^B	
	1.2 i		09.94-08.00	33/48	Fg.-Nr. T3000001→	BO	0 265 216 410 ^B	
	1.4 i		09.94-08.00	44/60/63/66	Fg.-Nr. T3000001→	BO	0 265 216 410 ^B	
	1.5 D, TD, XTD		09.94-08.00	37/49	Fg.-Nr. T3000001→	BO	0 265 216 410 ^B	
	1.6 GSI, i		09.94-08.00	74/78/80	Fg.-Nr. T3000001→	BO	0 265 216 410 ^B	
	1.7 D		09.94-08.00	44	Fg.-Nr. T3000001→	BO	0 265 216 410 ^B	

Corsa [C]

	1.0 i 12V		09.00-08.03	43		DEL, JBH	0 986 480 859	22
	1.0 Twinport	MFD	09.03-08.05	44		STB	0 204 123 639	22,2
						4SB	0 204 123 637	23,8
		OFD	09.03-08.05	44		STB	0 204 123 640	22,2
						4SB	F 026 003 638	23,81
	1.2 i 16V, 16V Dualfuel		09.00-08.04	55		DEL, JBH	0 986 480 859	22
	1.2 Twinport	MFD	09.04-09.06	59		STB	0 204 123 639	22,2
						4SB	0 204 123 637	23,8
	1.2 Twinport Dualfuel	OFD	09.04-09.06	59		STB	0 204 123 640	22,2
						4SB	F 026 003 638	23,81











◀ VAUXHALL Corsa [C]										
1.3 CDTI	ABO	09.03-09.06	51					0 204 123 659	22,2	
	MFD	09.03-09.06	51/55		STB			0 204 123 639	22,2	
					4SB			0 204 123 637	23,8	
	OFD	09.03-09.06	51/55		STB			0 204 123 640	22,2	
					4SB			F 026 003 638	23,81	
1.4 i 16V		09.00-08.03	66		DEL,JBH			0 986 480 859	22	
1.4 Twinport	MFD	09.03-08.05	66		STB			0 204 123 639	22,2	
					4SB			0 204 123 637	23,8	
	OFD	09.03-08.05	66		STB			0 204 123 640	22,2	
					4SB			F 026 003 638	23,81	
1.7 CDTI	MFD	09.03-08.05	74		STB			0 204 123 639	22,2	
					4SB			0 204 123 637	23,8	
	OFD	09.03-08.05	74		STB			0 204 123 640	22,2	
					4SB			F 026 003 638	23,81	
1.7 DI, DTI		09.00-08.03	48/55		DEL,JBH			0 986 480 859	22	
1.3 CDTI	ABO	09.03-09.06	51					0 204 125 812		
	ABS	09.03-09.06	51					0 204 125 813		
1.0 i 12V		09.00-08.03	43		TW			0 986 486 584	31	
								0 986 486 588	31	
1.0 Twinport		09.03-08.05	44		EAY			0 986 486 588	31	
					GS			0 986 486 584	31	
1.2 i 16V		09.00-08.04	55		TW			0 986 486 584	31	
1.2 16V Dualfuel								0 986 486 588	31	
1.2 Twinport, Twinport Dualfuel		09.04-09.06	59					0 986 486 588	31	
1.3 CDTI		09.03-09.06	51/55					0 986 486 588	31	
1.4 i 16V		09.00-08.05	66		EAY			0 986 486 588	31	
1.4 Twinport					GS			0 986 486 584	31	
1.6 i		09.01-08.03	62					0 986 486 588	31	
1.7 CDTI, DI, DTI		09.00-08.05	48/55/74					0 986 486 588	31	
1.8 i 16V		09.01-08.05	92					0 986 486 588	31	
1.4 i 16V		09.00-08.03	66					0 204 031 108 ^A		
	1.7 DI, DTI	09.00-08.03	48/55					0 204 031 108 ^A		
1.0 i 12V		09.00-08.03	43		STB			0 265 216 479 ^B		
	1.0 Twinport	09.03-08.05	44					0 265 231 307 ^B		
								0 265 234 051 ^T		
1.2 i 16V		09.00-08.04	55					0 265 234 051 ^T		
1.2 16V Dualfuel					Fg.-Nr. →33999999, →34999999, →36999999	STB		0 265 216 479 ^B		
					Fg.-Nr. 43000001→, 44000001→, 46000001→	STB		0 265 216 479 ^B		
1.2 Twinport		09.04-09.06	59					0 265 232 213 ^B		
1.2 Twinport Dualfuel		09.04-09.06	59		Fg.-Nr. 53000001→, 54000001→, 56000001→	GS		0 265 232 213 ^B		
1.2 Twinport, Twinport Dualfuel		09.04-09.06	59					0 265 234 051 ^T		
1.3 CDTI		09.03-09.06	51					0 265 231 307 ^B		
								0 265 234 051 ^T		
								0 265 234 340 ^T		
					Fg.-Nr. 53000001→, 54000001→, 56000001→	GS		0 265 232 213 ^B		
1.4 i 16V		09.00-08.03	66		Fg.-Nr. →33999999, →34999999, →36999999	STB		0 265 216 479 ^B		
					Fg.-Nr. 43000001→, 44000001→, 46000001→	STB		0 265 216 479 ^B		
1.4 Twinport		09.03-08.05	66					0 265 231 307 ^B		
								0 265 234 051 ^T		
1.6 i		09.01-08.03	62					0 265 234 051 ^T		
						STB		0 265 216 479 ^B		

		S							
1.7 CDTI		09.03-08.05	74				0 265 231 444 ^B		
							0 265 234 051 ^T		
1.7 Di, DTI		09.00-08.03	48/55		STB		0 265 216 479 ^B		
1.8 i 16V		09.01-08.05	92		Fg.-Nr. →33999999, →34999999, →36999999		0 265 220 659 ^F		
					Fg.-Nr. →44999999, →46999999		0 265 234 051 ^T		
					Fg.-Nr. 54000001→, 56000001→		0 265 232 215 ^B		
							0 265 234 340 ^T		
 1.0 Twinport		09.03-08.05	44				0 265 005 270		
1.2 Twinport, Twinport Dualfuel		09.04-09.06	59				0 265 005 270		
1.3 CDTI		09.03-09.06	51				0 265 005 270		
1.4 Twinport		09.03-08.05	66				0 265 005 270		
1.7 CDTI		09.03-08.05	74				0 265 005 270		
1.8 i 16V		09.01-08.05	92				0 265 005 270		
 1.2 Twinport, Twinport Dualfuel		09.04-09.06	59				0 265 005 303		
1.3 CDTI		09.05-09.06	55				0 265 005 303		
1.8 i 16V		09.01-08.05	92				0 265 005 303		
Corsa [D]									
									
 1.0 Twinport	MFD	07.06-10.09	44		LLE		0 204 123 739	22,2	
					RLE		0 204 123 743	22,2	
		12.09→	48		LLE		0 204 123 739	22,2	
					RLE		0 204 123 743	22,2	
	OFD	07.06-10.09	44		LLE		0 204 123 738	22,2	
					RLE		0 204 123 742	22,2	
		12.09→	48		LLE		0 204 123 738	22,2	
					RLE		0 204 123 742	22,2	
1.2 i LPG	MFD	07.06→	51/55-59/		LLE		0 204 123 739	22,2	
1.2 i Twinport			63		RLE		0 204 123 743	22,2	
1.2 Twinport	OFD	07.06→	51/55-59/		LLE		0 204 123 738	22,2	
			63		RLE		0 204 123 742	22,2	
1.3 CDTI	MFD	07.06-03.09	55		LLE		0 204 123 739	22,2	
					RLE		0 204 123 743	22,2	
		07.06-07.10	66		LLE		0 204 123 739	22,2	
					RLE		0 204 123 743	22,2	
		12.09-09.10	70		LLE		0 204 123 739	22,2	
					RLE		0 204 123 743	22,2	
		01.11→	55/70		LLE		0 204 123 739	22,2	
					RLE		0 204 123 743	22,2	
	OFD	07.06-03.09	55		LLE		0 204 123 738	22,2	
					RLE		0 204 123 742	22,2	
		07.06-07.10	66		LLE		0 204 123 738	22,2	
					RLE		0 204 123 742	22,2	
		12.09-09.10	70		LLE		0 204 123 738	22,2	
					RLE		0 204 123 742	22,2	
		01.11→	55/70		LLE		0 204 123 738	22,2	
					RLE		0 204 123 742	22,2	
1.4 LPG	MFD	07.06→	64/65-66/		LLE		0 204 123 739	22,2	
1.4 Twinport			74		RLE		0 204 123 743	22,2	
	OFD	07.06→	64/65-66/		LLE		0 204 123 738	22,2	
			74		RLE		0 204 123 742	22,2	
1.4 Twinport Turbo	MFD	07.12→	88		LLE		0 204 123 740	23,81	
					RLE		0 204 123 744	23,81	
	OFD	07.12→	88		LLE		0 204 123 741	23,81	
					RLE		0 204 123 745	23,81	
1.6 i OPC Turbo	MFD	02.07→	110/141/		LLE		0 204 123 740	23,81	
1.6 i Turbo			151		RLE		0 204 123 744	23,81	
	OFD	02.07→	110/141/		LLE		0 204 123 741	23,81	
			151		RLE		0 204 123 745	23,81	











		S							
VAUXHALL Corsa [D]									
1.7 CDTI	MFD	07.06→	92/96	LLE	0 204 123 740	23,81			
				RLE	0 204 123 744	23,81			
	OFD	07.06→	92/96	LLE	0 204 123 741	23,81			
				RLE	0 204 123 745	23,81			
1.0 Twinport	MFD	07.06-10.09	44	LLE	0 204 125 870				
				LLE	0 204 125 870				
	OFD	07.06-10.09	44	LLE,TW	0 204 125 870				
				RLE,TW	0 204 776 113				
		12.09→	48	LLE,TW	0 204 776 115				
				LLE,TW	0 204 125 870				
		12.09→	48	LLE,TW	0 204 125 870				
				RLE,TW	0 204 776 113				
1.2 i LPG	MFD	12.09-12.11	55-59	LLE	0 204 125 870				
	OFD	12.09-12.11	55-59	LLE,TW	0 204 125 870				
	RLE,TW			0 204 776 113					
1.2 i Twinport	MFD	12.09→	51	LLE	0 204 125 870				
	OFD	12.09→	51	LLE,TW	0 204 125 870				
	RLE,TW			0 204 776 113					
1.2 Twinport	MFD	07.06-12.11	59	LLE	0 204 125 870				
				LLE	0 204 125 870				
	OFD	07.06-12.11	59	LLE,TW	0 204 125 870				
				RLE,TW	0 204 776 113				
		12.09→	63	LLE,TW	0 204 776 115				
				LLE,TW	0 204 125 870				
		12.09→	63	LLE,TW	0 204 125 870				
				RLE,TW	0 204 776 113				
1.3 CDTI	07.06-07.10	66	LLE	0 204 125 870					
			LLE,TW	0 204 125 870					
	12.09-09.10	70	LLE,TW	0 204 776 113					
			RLE,TW	0 204 776 115					
	01.11→	55	LLE,TW	0 204 125 870					
			RLE,TW	0 204 776 113					
			70	LLE,TW	0 204 776 115				
				LLE,TW	0 204 125 870				
				LLE,TW	0 204 776 113				
				RLE,TW	0 204 776 115				
	MFD	07.06-03.09	55	LLE	0 204 125 870				
OFD	07.06-03.09	55	LLE,TW	0 204 125 870					
RLE,TW			0 204 776 113						
1.4 LPG	MFD	12.09-11.10	65-66	LLE	0 204 125 870				
	OFD	12.09-11.10	65-66	LLE,TW	0 204 125 870				
RLE,TW			0 204 776 113						
1.4 Twinport	MFD	07.06-11.10	66	LLE	0 204 125 870				
				LLE	0 204 125 870				
	12.09→	64	LLE	0 204 125 870					
			LLE	0 204 125 870					
	OFD	07.06-11.10	66	LLE,TW	0 204 125 870				
				RLE,TW	0 204 776 113				
		12.09→	64	LLE,TW	0 204 776 115				
				LLE,TW	0 204 125 870				
			LLE,TW	0 204 776 113					
			RLE,TW	0 204 776 115					
1.4 Twinport Turbo	07.12→	88	LLE	0 204 125 869					
			LLE	0 204 125 869					
1.6 i OPC Turbo, i Turbo	02.07→	110/141/151	LLE	0 204 125 869					
1.7 CDTI	07.06→	92/96	LLE	0 204 125 869					

		S									
 1.0 Twinport	07.06-10.09	44	Get.-Nr. F13	GS	0 986 486 584	31					
			Get.-Nr. F13, Get.-Nr. F17	EAY,GS,TW	0 986 486 588	31					
			Get.-Nr. M20	EAY	0 986 486 589	34					
				GS	0 986 486 591	34					
			12.09→	48	Get.-Nr. F13	MG5,TW	0 986 486 584	31			
					Get.-Nr. F13, Get.-Nr. F17	EAY,MG5,TW	0 986 486 588	31			
1.2 i LPG 1.2 i Twinport 1.2 Twinport	07.06→	51/55-59/ 63	Get.-Nr. F13	MG5,TW	0 986 486 584	31					
			Get.-Nr. F13, Get.-Nr. F17	EAY,MG5,TW	0 986 486 588	31					
			Get.-Nr. M20	EAY	0 986 486 589	34					
			Get.-Nr. M20, Get.-Nr. M32	MG6	0 986 486 591	34					
1.3 CDTi	07.06-03.09	55	Get.-Nr. F13	GS,TW	0 986 486 584	31					
			Get.-Nr. F13, Get.-Nr. F17	EAY,GS,TW	0 986 486 588	31					
			Get.-Nr. M20	EAY	0 986 486 589	34					
				GS	0 986 486 591	34					
	07.06-07.10	66	Get.-Nr. F13	GS	0 986 486 584	31					
			Get.-Nr. F13, Get.-Nr. F17	EAY,GS,TW	0 986 486 588	31					
			Get.-Nr. M20	EAY	0 986 486 589	34					
	12.09-09.10	70	Get.-Nr. F13	GS,TW	0 986 486 584	31					
			Get.-Nr. F13, Get.-Nr. F17	EAY,GS,TW	0 986 486 588	31					
			Get.-Nr. M20	EAY,TW	0 986 486 589	34					
				GS,TW	0 986 486 591	34					
	01.11→	55/70	Get.-Nr. F13	GS,TW	0 986 486 584	31					
Get.-Nr. F13, Get.-Nr. F17			EAY,GS,TW	0 986 486 588	31						
Get.-Nr. M20			EAY,TW	0 986 486 589	34						
1.4 LPG 1.4 Twinport	07.06-11.10	65-66	Get.-Nr. F13	MG5,TW	0 986 486 584	31					
			Get.-Nr. F13, Get.-Nr. F17	EAY,MG5,TW	0 986 486 588	31					
			Get.-Nr. M20	EAY	0 986 486 589	34					
				MG6	0 986 486 591	34					
1.4 Twinport	12.09→	64	Get.-Nr. F13	MG5,TW	0 986 486 584	31					
			Get.-Nr. F13, Get.-Nr. F17	EAY,MG5,TW	0 986 486 588	31					
			Get.-Nr. M20	EAY	0 986 486 589	34					
			Get.-Nr. M20, Get.-Nr. M32	MG6	0 986 486 591	34					
1.4 Twinport 1.4 Twinport Turbo	12.09→	74/88	Get.-Nr. F13	MG5,TW	0 986 486 584	31					
			Get.-Nr. F13, Get.-Nr. F17	EAY,MG5,TW	0 986 486 588	31					
			Get.-Nr. M20	EAY	0 986 486 589	34					
			Get.-Nr. M20, Get.-Nr. M32	MG6	0 986 486 591	34					
1.6 i OPC Turbo	02.07-06.10	141	Get.-Nr. F13	MG5,TW	0 986 486 584	31					
			Get.-Nr. F13, Get.-Nr. F17	EAY,MG5,TW	0 986 486 588	31					
			Get.-Nr. M20	EAY	0 986 486 589	34					
			Get.-Nr. M20, Get.-Nr. M32	MG6	0 986 486 591	34					
	01.11→	141	Get.-Nr. F13	MG5,TW	0 986 486 584	31					
			Get.-Nr. F13, Get.-Nr. F17	EAY,MG5,TW	0 986 486 588	31					
			Get.-Nr. M20	EAY	0 986 486 589	34					
	10.11→	151	Get.-Nr. F13	MG5,TW	0 986 486 584	31					
			Get.-Nr. F13, Get.-Nr. F17	EAY,MG5,TW	0 986 486 588	31					
			Get.-Nr. M20	EAY	0 986 486 589	34					
	1.6 i Turbo	10.07-10.09	110	Get.-Nr. F13	TW	0 986 486 584	31				
				Get.-Nr. F13, Get.-Nr. F17	TW	0 986 486 588	31				
Get.-Nr. M20, Get.-Nr. M32				GS	0 986 486 591	34					
10.07→		110	Get.-Nr. M20	EAY	0 986 486 589	34					
11.09→		110	Get.-Nr. F13	MG5,TW	0 986 486 584	31					
			Get.-Nr. F13, Get.-Nr. F17	EAY,MG5,TW	0 986 486 588	31					
			Get.-Nr. M20, Get.-Nr. M32	MG6	0 986 486 591	34					



VAUXHALL Corsa [D]										
1.7 CDTI	07.06→	92/96	Get.-Nr. F13	GS,TW	0 986 486 584	31				
			Get.-Nr. F13, Get.-Nr. F17	EAY,GS,TW	0 986 486 588	31				
			Get.-Nr. M20	EAY,TW	0 986 486 589	34				
				GS,TW	0 986 486 591	34				
			Get.-Nr. M32	GS,TW	0 986 486 594	34				
1.0 Twinport	07.06-10.09	44	Fg.-Nr. →74999999, →76999999		0 265 232 239 ^B					
			Fg.-Nr. →84999999, →86999999	MBH	0 265 230 288 ^T					
			Fg.-Nr. B4000001→, B6000001→	MBH	0 265 230 286 ^T					
			Fg.-Nr. B4000001→, B6000001→	MBH	0 265 251 871 ^T					
			Fg.-Nr. B4000001→, B6000001→	MBH	0 265 251 870 ^T					
			Fg.-Nr. 84000001→84999999, 86000001→86999999		0 265 232 239 ^B					
			Fg.-Nr. 94000001→, 96000001→	SSJ	0 265 232 289 ^B					
	12.09→	48		SSJ	0 265 232 289 ^B					
			Fg.-Nr. B4000001→, B6000001→	MBH	0 265 251 871 ^T					
			Fg.-Nr. B4000001→, B6000001→	MBH	0 265 251 870 ^T					
1.2 i LPG	12.09→	51/55-59		SSJ	0 265 232 289 ^B					
1.2 i Twinport			Fg.-Nr. B4000001→, B6000001→	MBH	0 265 251 871 ^T					
			Fg.-Nr. B4000001→, B6000001→	MBH	0 265 251 870 ^T					
1.2 Twinport	07.06-12.11	59	Fg.-Nr. →74999999, →76999999		0 265 232 239 ^B					
			Fg.-Nr. →84999999, →86999999	MBH	0 265 230 288 ^T					
			Fg.-Nr. B4000001→, B6000001→	MBH	0 265 230 286 ^T					
			Fg.-Nr. B4000001→, B6000001→	MBH	0 265 251 871 ^T					
			Fg.-Nr. B4000001→, B6000001→	MBH	0 265 251 870 ^T					
			Fg.-Nr. 84000001→84999999, 86000001→86999999		0 265 232 239 ^B					
			Fg.-Nr. 94000001→, 96000001→	SSJ	0 265 232 289 ^B					
	12.09→	63		SSJ	0 265 232 289 ^B					
			Fg.-Nr. B4000001→, B6000001→	MBH	0 265 251 871 ^T					
			Fg.-Nr. B4000001→, B6000001→	MBH	0 265 251 870 ^T					
1.3 CDTI	07.06-03.09	55	Fg.-Nr. →74999999, →76999999		0 265 232 239 ^B					
			Fg.-Nr. →84999999, →86999999	MBH	0 265 230 288 ^T					
			Fg.-Nr. B4000001→, B6000001→	MBH	0 265 230 286 ^T					
			Fg.-Nr. B4000001→, B6000001→	MBH	0 265 251 871 ^T					
			Fg.-Nr. B4000001→, B6000001→	MBH	0 265 251 870 ^T					
			Fg.-Nr. 84000001→84999999, 86000001→86999999		0 265 232 239 ^B					
	Fg.-Nr. 94000001→, 96000001→	SSJ	0 265 232 289 ^B							
		07.06-07.10	66	Fg.-Nr. →74999999, →76999999		0 265 232 239 ^B				
	Fg.-Nr. →84999999, →86999999			MBH	0 265 230 288 ^T					
	Fg.-Nr. B4000001→, B6000001→			MBH	0 265 230 286 ^T					
		10.06-02.09	66	Fg.-Nr. 84000001→84999999, 86000001→86999999		0 265 232 239 ^B				
	Fg.-Nr. 94000001→, 96000001→			SSJ	0 265 232 289 ^B					
						MBH	0 265 235 060 ^T			
				MBH	0 265 235 164 ^T					
				RDK	0 265 232 239 ^T					
				RDK	0 265 231 844 ^T					
	12.09-09.10	70		SSJ	0 265 232 289 ^B					
	01.11→	55		MBH	0 265 251 871 ^T					
			MBH	0 265 251 870 ^T						
			SSJ	0 265 232 289 ^B						
		70	Fg.-Nr. B4000001→, B6000001→	MBH	0 265 251 871 ^T					
			Fg.-Nr. B4000001→, B6000001→	MBH	0 265 251 870 ^T					
1.4 LPG	12.09-11.10	65-66		SSJ	0 265 232 289 ^B					



		S									
1.4 Twinport	07.06-11.10	66	Fg.-Nr. →74999999, →76999999				0 265 232 239 ^B				
			Fg.-Nr. →84999999, →86999999	MBH			0 265 230 288 ^T				
				MBH			0 265 230 286 ^T				
			Fg.-Nr. 84000001→84999999, 86000001→86999999				0 265 232 239 ^B				
			Fg.-Nr. 94000001→, 96000001→	SSJ			0 265 232 289 ^B				
			12.09→	64			SSJ		0 265 232 289 ^B		
					Fg.-Nr. B4000001→, B6000001→	MBH			0 265 251 871 ^T		
						MBH			0 265 251 870 ^T		
				74			SSJ		0 265 232 289 ^B		
					Fg.-Nr. B4000001→, B6000001→	MBH			0 265 251 871 ^T		
			MBH			0 265 251 870 ^T					
1.4 Twinport Turbo	07.12→	88				MBH	0 265 251 871 ^T				
						MBH	0 265 251 870 ^T				
						SSJ	0 265 232 289 ^B				
1.6 OPC Turbo	02.07-06.10	141	Fg.-Nr. →74999999, →76999999				0 265 232 239 ^B				
			Fg.-Nr. →84999999, →86999999	MBH			0 265 230 288 ^T				
				MBH			0 265 230 286 ^T				
			Fg.-Nr. B4000001→, B6000001→	MBH			0 265 251 871 ^T				
				MBH			0 265 251 870 ^T				
			Fg.-Nr. 84000001→84999999, 86000001→86999999				0 265 232 239 ^B				
			Fg.-Nr. 94000001→, 96000001→	SSJ			0 265 232 289 ^B				
			01.11→	141			MBH		0 265 251 871 ^T		
							MBH		0 265 251 870 ^T		
							SSJ		0 265 232 289 ^B		
10.11→	151			MBH		0 265 251 871 ^T					
				MBH		0 265 251 870 ^T					
				SSJ		0 265 232 289 ^B					
1.6 i Turbo	10.07-10.09	110	Fg.-Nr. →84999999, →86999999	MBH			0 265 230 288 ^T				
				MBH			0 265 230 286 ^T				
			Fg.-Nr. 94000001→, 96000001→	SSJ			0 265 232 289 ^B				
			11.09→	110			SSJ		0 265 232 289 ^B		
		Fg.-Nr. B4000001→, B6000001→	MBH			0 265 251 871 ^T					
			MBH			0 265 251 870 ^T					
1.7 CDTI	07.06-02.09	92				MBH	0 265 235 060 ^T				
						MBH	0 265 235 164 ^T				
						RDK	0 265 232 239 ^T				
						RDK	0 265 231 844 ^T				
	07.06-06.10	92	Fg.-Nr. →74999999, →76999999				0 265 232 239 ^B				
			Fg.-Nr. →84999999, →86999999	MBH			0 265 230 288 ^T				
				MBH			0 265 230 286 ^T				
			Fg.-Nr. B4000001→, B6000001→	MBH			0 265 251 871 ^T				
				MBH			0 265 251 870 ^T				
			Fg.-Nr. 84000001→84999999, 86000001→86999999				0 265 232 239 ^B				
Fg.-Nr. 94000001→, 96000001→	SSJ			0 265 232 289 ^B							
12.09→	96			SSJ		0 265 232 289 ^B					
		Fg.-Nr. B4000001→, B6000001→	MBH			0 265 251 871 ^T					
			MBH			0 265 251 870 ^T					
 1.3 CDTI	10.06-02.09	66				MBH	0 265 005 657				
						MBH	0 265 005 816				
1.7 CDTI	07.06-02.09	92				MBH	0 265 005 657				
						MBH	0 265 005 816				





◀ VAUXHALL

Corsa [E]



	1.0	10.14→	66/85	LLE,STB	0 204 803 866	22,2
				RLE,STB	0 204 123 743	22,2
				4SB,LLE	0 204 822 479	
				4SB,RLE	0 204 123 744	23,81
	1.2	10.14→	51	LLE,STB	0 204 803 866	22,2
				RLE,STB	0 204 123 743	22,2
				4SB,LLE	0 204 822 479	
				4SB,RLE	0 204 123 744	23,81
	1.3	10.14→	55/70	LLE,STB	0 204 803 866	22,2
				RLE,STB	0 204 123 743	22,2
				4SB,LLE	0 204 822 479	
				4SB,RLE	0 204 123 744	23,81
	1.4	10.14→	66/74	LLE,STB	0 204 803 866	22,2
				RLE,STB	0 204 123 743	22,2
				4SB,LLE	0 204 822 479	
				4SB,RLE	0 204 123 744	23,81
	1.6	05.15→	148-152	LLE,STB	0 204 803 866	22,2
				RLE,STB	0 204 123 743	22,2
				4SB,LLE	0 204 822 479	
				4SB,RLE	0 204 123 744	23,81

















	1.0	10.14→	66/85	LLE,STB	0 204 125 870	
				4SB,LLE,VSP	0 204 125 869	
				4SB,LLE,SBJ	0 204 831 726	
				4SB,RLE,SBJ	0 204 831 728	
	1.2	10.14→	51	LLE,STB	0 204 125 870	
				4SB,LLE,VSP	0 204 125 869	
				4SB,LLE,SBJ	0 204 831 726	
				4SB,RLE,SBJ	0 204 831 728	
	1.3	10.14→	55/70	LLE,STB	0 204 125 870	
				4SB,LLE,VSP	0 204 125 869	
				4SB,LLE,SBJ	0 204 831 726	
				4SB,RLE,SBJ	0 204 831 728	
	1.4	10.14→	66/74	LLE,STB	0 204 125 870	
				4SB,LLE,VSP	0 204 125 869	
				4SB,LLE,SBJ	0 204 831 726	
				4SB,RLE,SBJ	0 204 831 728	
	1.6	05.15→	148-152	LLE,STB	0 204 125 870	
				4SB,LLE,VSP	0 204 125 869	
				4SB,LLE,SBJ	0 204 831 726	
				4SB,RLE,SBJ	0 204 831 728	

	1.6	05.15→	148-152	Get.-Nr. M32	MG6	0 986 486 591	34
--	------------	--------	---------	--------------	-----	----------------------	----

Frontera [A]























	2.0 i	02.95-08.98	85	Fg.-Nr. TV815831→	LLE	0 204 123 508
				Fg.-Nr. TV818522→	RLE	0 204 123 508
	2.2 i	02.95-08.98	100	Fg.-Nr. TV815831→	LLE	0 204 123 508
				Fg.-Nr. TV818522→	RLE	0 204 123 508
	2.5 TDS Turbo	06.96-08.98	85	Fg.-Nr. TV814227→	LLE	0 204 123 508
				Fg.-Nr. TV822888→	RLE	0 204 123 508
	2.8 TDI Turbo	02.95-08.98	83	Fg.-Nr. TV814227→	LLE	0 204 123 508
				Fg.-Nr. TV822888→	RLE	0 204 123 508

		S							
Insignia Sports Tourer [35]									
									
	1.6	02.09→	85/132	Fg.-Nr. →91999999			0 265 005 543		
	1.8	02.09→	103	Fg.-Nr. →91999999			0 265 005 543		
	2.0 CDTI, CDTI 4x4, Turbo, 4x4	02.09→	81/96/118/ 140-143/162		TW		0 265 005 543		
	2.8 Turbo 4x4	02.09→	191/239	Fg.-Nr. →91999999			0 265 005 543		
Insignia [68]									
									
	1.6	11.08→	85/132	Fg.-Nr. →91999999			0 265 005 543		
	1.8	11.08→	103	Fg.-Nr. →91999999			0 265 005 543		
	2.0 CDTI, CDTI 4x4, Turbo, Turbo 4x4	11.08→	81/96/118/ 140-143/162		TW		0 265 005 543		
	2.8 Turbo 4x4	11.08→	191/239	Fg.-Nr. →91999999			0 265 005 543		
Insignia [69]									
									
	1.6	11.08→	85/132	Fg.-Nr. →91999999			0 265 005 543		
	1.8	11.08→	103	Fg.-Nr. →91999999			0 265 005 543		
	2.0 CDTI, CDTI 4x4, Turbo, Turbo 4x4	11.08→	81/96/118/ 140-143/162		TW		0 265 005 543		
	2.8 Turbo 4x4	11.08→	191/239	Fg.-Nr. →91999999			0 265 005 543		
Meriva [A]									
									
	1.3 CDTI	MFD 09.03-03.10	55	Fg.-Nr. →44999999	JBH		0 986 480 884	23,8	
				Fg.-Nr. 54000001→64999999			0 204 123 663	23,8	
		09.05-03.10	51	Fg.-Nr. →44999999	JBH		0 986 480 884	23,8	
				Fg.-Nr. 54000001→64999999			0 204 123 663	23,8	
				Fg.-Nr. 54000001→74237191			0 204 123 663	23,8	
		OFD 09.03-03.10	55	Fg.-Nr. →44999999	JBH		0 986 480 885	23,8	
				Fg.-Nr. 54000001→64999999			0 204 123 664	23,8	
		09.05-03.10	51	Fg.-Nr. →44999999	JBH		0 986 480 885	23,8	
				Fg.-Nr. 54000001→64999999			0 204 123 664	23,8	
				Fg.-Nr. 54000001→74237191			0 204 123 664	23,8	
	1.4 16V Twinport	MFD 07.04-03.10	66	Fg.-Nr. →44999999	JBH		0 986 480 884	23,8	
				Fg.-Nr. 54000001→64999999			0 204 123 663	23,8	
		OFD 07.04-03.10	66	Fg.-Nr. →44999999	JBH		0 986 480 885	23,8	
				Fg.-Nr. 54000001→64999999			0 204 123 664	23,8	
	1.6 i	MFD 03.03-03.10	64/74/77/	Fg.-Nr. →44999999	JBH		0 986 480 884	23,8	
	1.6 i OPC Turbo		132	Fg.-Nr. 54000001→64999999			0 204 123 663	23,8	
	1.6 i 16V	OFD 03.03-03.10	64/74/77/	Fg.-Nr. →44999999	JBH		0 986 480 885	23,8	
			132	Fg.-Nr. 54000001→64999999			0 204 123 664	23,8	
	1.7 CDTI	MFD 03.03-03.10	55/74/92	Fg.-Nr. →44999999	JBH		0 986 480 884	23,8	
	1.7 DTI			Fg.-Nr. 54000001→64999999			0 204 123 663	23,8	
		OFD 03.03-03.10	55/74/92	Fg.-Nr. →44999999	JBH		0 986 480 885	23,8	
				Fg.-Nr. 54000001→64999999			0 204 123 664	23,8	
	1.8 i 16V	MFD 03.03-03.10	92	Fg.-Nr. →44999999	JBH		0 986 480 884	23,8	
				Fg.-Nr. 54000001→64999999			0 204 123 663	23,8	
		OFD 03.03-03.10	92	Fg.-Nr. →44999999	JBH		0 986 480 885	23,8	
				Fg.-Nr. 54000001→64999999			0 204 123 664	23,8	
	1.3 CDTI	09.03-03.10	55	Fg.-Nr. 54000001→64999999			0 204 125 827		
		09.05-03.10	51	Fg.-Nr. 54000001→64999999			0 204 125 827		
				Fg.-Nr. 54000001→74237191			0 204 125 827		
	1.4 16V Twinport	07.04-03.10	66	Fg.-Nr. 54000001→64999999			0 204 125 827		



VAUXHALL Meriva [A]										
	1.6 i, i OPC Turbo, i 16V	03.03-03.10	64/74/77/132	Fg.-Nr. 54000001→64999999			0 204 125 827			
	1.7 CDTI, DTI	03.03-03.10	55/74/92	Fg.-Nr. 54000001→64999999			0 204 125 827			
	1.8 i 16V	03.03-03.10	92	Fg.-Nr. 54000001→64999999			0 204 125 827			
	1.3 CDTI	09.03-03.10	51/55				0 986 486 588	31		
	1.4 16V Twinport	07.04-03.10	66				0 986 486 588	31		
	1.6 i, i OPC Turbo, i 16V	03.03-03.10	64/74/77/132				0 986 486 588	31		
	1.7 CDTI, DTI	03.03-09.09	55/74				0 986 486 588	31		
	1.8 i 16V	03.03-03.10	92				0 986 486 588	31		
	1.3 CDTI	09.03-03.10	55	Fg.-Nr. →44999999			0 265 202 503 ^T			
							0 265 216 479 ^B			
							0 265 220 659 ^F			
				Fg.-Nr. 54000001→			0 265 232 213 ^B			
							0 265 234 051 ^T			
		09.05-03.10	51	Fg.-Nr. →44999999			0 265 202 503 ^T			
							0 265 216 479 ^B			
							0 265 220 659 ^F			
				Fg.-Nr. 54000001→			0 265 232 213 ^B			
							0 265 234 051 ^T			
				Fg.-Nr. 54000001→54999999			0 265 234 340 ^T			
				Fg.-Nr. 64000001→	MBH		0 265 234 697 ^T			
					MBH		0 265 234 695 ^T			
	1.4 16V Twinport	07.04-03.10	66	Fg.-Nr. 54000001→			0 265 232 213 ^B			
							0 265 234 051 ^T			
	1.6 i OPC Turbo	09.05-03.10	77/132	Fg.-Nr. →44999999			0 265 202 503 ^T			
	1.6 i 16V						0 265 216 479 ^B			
							0 265 220 659 ^F			
				Fg.-Nr. 54000001→			0 265 232 213 ^B			
							0 265 234 051 ^T			
	1.6 i	03.03-02.06	64/74				0 265 202 503 ^T			
	1.6 i 16V						0 265 216 479 ^B			
	1.7 CDTI	09.03-09.09	74				0 265 202 503 ^T			
				Fg.-Nr. →44999999			0 265 220 659 ^F			
	1.7 DTI	03.03-09.05	55				0 265 202 503 ^T			
							0 265 216 479 ^B			
	1.8 i 16V	03.03-03.10	92				0 265 202 503 ^T			
				Fg.-Nr. →44999999			0 265 220 659 ^F			
	1.3 CDTI	09.03-03.10	51/55	Fg.-Nr. →44999999			0 265 005 262			
				Fg.-Nr. 54000001→54999999			0 265 005 270			
				Fg.-Nr. 64000001→	MBH		0 265 005 657			
					MBH		0 265 005 816			
	1.4 16V Twinport	07.04-03.10	66				0 265 005 262			
	1.6 i OPC Turbo	09.05-03.10	77/132	Fg.-Nr. →44999999			0 265 005 262			
	1.6 i 16V			Fg.-Nr. 54000001→54999999			0 265 005 270			
				Fg.-Nr. 64000001→	MBH		0 265 005 657			
					MBH		0 265 005 816			
	1.6 i, i 16V	03.03-02.06	64/74				0 265 005 262			
	1.7 CDTI	09.06-03.10	92	Fg.-Nr. →44999999			0 265 005 262			
				Fg.-Nr. 54000001→54999999			0 265 005 270			
				Fg.-Nr. 64000001→	MBH		0 265 005 657			
					MBH		0 265 005 816			
	1.7 CDTI, DTI	03.03-09.09	55/74				0 265 005 262			
	1.8 i 16V	03.03-03.10	92				0 265 005 262			
	1.3 CDTI	09.03-03.10	51/55				0 265 005 303			
	1.4 16V Twinport	07.04-03.10	66				0 265 005 303			
	1.6 i OPC Turbo, i 16V	09.05-03.10	77/132				0 265 005 303			
	1.7 CDTI	09.06-03.10	92				0 265 005 303			

									
Meriva [B]									
									
	1.4 ecoFLEX	04.10→	88	Get.-Nr. F13, Get.-Nr. F17 Get.-Nr. M32	TW TW	0 986 486 588 0 986 486 591	31 34		
	1.4 Ecotec	04.10→	74			0 986 486 588	31		
	1.4 Ecotec, Turbo	04.10→	103			0 986 486 591	34		
	1.4 Turbo	10.12→	88			0 986 486 591	34		
	1.6 CDTI	10.13→	70/81/100			0 986 486 590	34		
	1.7 CDTI	04.10→	74/81/96			0 986 486 590	34		
Mokka									
									
	1.4 Turbo ecoFLEX	03.15→	103	Fg.-Nr. →EB999999, Get.-Nr. M32	MG6,TW	0 986 486 590 0 986 486 591	34 34		
	1.4 Turbo ecoFLEX 4x4	09.12→	103	Get.-Nr. M32	MG6,TW	0 986 486 590 0 986 486 591	34 34		
	1.6 Turbo ecoFlex	03.15→	85	Fg.-Nr. →EB999999, Get.-Nr. M32	MG6,TW	0 986 486 590 0 986 486 591	34 34		
	1.6 Turbo ecoFLEX	09.12→	85	Get.-Nr. M32	MG6,TW	0 986 486 590 0 986 486 591	34 34		
	1.7 CDTI ecoFLEX	09.12→	96	Get.-Nr. M32	MG6,TW	0 986 486 590	34		
	1.7 CDTI ecoFLEX 4x4					0 986 486 591	34		
Monterey [A]									
									
	3.1 TD	10.95-08.98	84			0 204 123 508			
	3.2 i	10.95-08.98	130			0 204 123 508			
Monterey [B]									
									
	3.0 DTI	02.98-12.99	117			0 204 123 508			
	3.5 i V6	02.98-12.99	158			0 204 123 508			
Movano [A]									
									
	1.9 D	ABO 01.99-10.01	59			0 204 123 651	23,8		
		ABS 01.99-10.01	59			0 204 123 409			
	1.9 DTI	ABO 10.01-10.05	60			0 204 123 651	23,8		
		ABS 10.01-10.05	60			0 204 123 409			
	2.2 DTI	ABO 01.01-10.05	66			0 204 123 651	23,8		
		ABS 01.01-10.05	66			0 204 123 409			
	2.5 D	ABO 10.98-03.10	59/74-84			0 204 123 651	23,8		
	2.5 DTI	ABS 10.98-03.10	59/74-84			0 204 123 409			
	2.5 DTI	ABO 10.01-03.07	84			0 204 123 651	23,8		
		ABS 10.01-03.07	84			0 204 123 409			
	2.8 DTI	ABO 06.98-10.05	84			0 204 123 651	23,8		
		ABS 06.98-10.05	84			0 204 123 409			
	3.0 DTI	ABO 10.03-10.05	100	Fg.-Nr. →3V999999, →3Y999999		0 204 123 651	23,8		
		ABS 10.03-10.05	100	Fg.-Nr. →3V999999, →3Y999999		0 204 123 409			
Nova									
									
	1.0	05.83-08.94	33		JBH,K04	0 986 480 095	20,64		
					JBH,K05	0 986 480 496	20,64		
					JBH,K08	0 986 480 483	20,64		

		S								
VAUXHALL Nova										
1.0		05.83-08.94	33	Fg.-Nr. →J4999999	JBH,K06	0 986 480 116	20,64			
					JBH,K11	0 986 480 616	20,64			
				Fg.-Nr. K4000001→	B05,JBH	0 986 480 128	20,6			
					JBH,K16	0 986 480 116	20,64			
1.2		05.83-08.94	33-39/		JBH,K07	0 986 480 117	20,64			
1.2 i			40-43		JBH,K08	0 986 480 483	20,64			
1.2 S				Fg.-Nr. →J4999999	JBH,K11	0 986 480 616	20,64			
					Fg.-Nr. K4000001→	JBH,K16	0 986 480 116	20,64		
1.3		05.83-08.94	51	Fg.-Nr. →J4999999	JBH,K07	0 986 480 117	20,64			
					Fg.-Nr. K4000001→	JBH,K11	0 986 480 616	20,64		
					Fg.-Nr. K4000001→	JBH,K16	0 986 480 116	20,64		
1.4, i		01.90-08.94	44/55/60	Fg.-Nr. K4000001→	JBH,K16	0 986 480 116	20,64			
1.5 D		09.87-08.94	37/49		JBH,K07	0 986 480 117	20,64			
1.5 TD				Fg.-Nr. →J4999999	JBH,K11	0 986 480 616	20,64			
					Fg.-Nr. K4000001→	JBH,K16	0 986 480 116	20,64		
1.6 i		05.88-08.94	74	Fg.-Nr. K4000001→	JBH,K16	0 986 480 116	20,64			
		05.89-08.94	55	Fg.-Nr. →J4999999	JBH,K11	0 986 480 616	20,64			
				Fg.-Nr. K4000001→	JBH,K16	0 986 480 116	20,64			
		05.83-08.94	33		B01,B02	0 986 485 006				
		05.83-08.94	33-39		B02	0 986 485 006				
		09.86-08.94	33		B01,B02	0 986 485 006				
		09.90-08.94	33		B02	0 986 485 006				
		05.83-08.94	40-43		B01,B02	0 986 485 006				
		05.83-08.94	51		B01,B02	0 986 485 006				
		01.90-08.94	44/55		B02	0 986 485 006				
		09.91-08.94	60			0 986 485 009				
		09.87-08.94	37/49			0 986 485 009				
		05.88-08.94	55/74			0 986 485 009				
Omega [B]										
		09.93-12.00	74/85/100	Fg.-Nr. W1000001→	LLE	0 986 480 846	25,4			
		09.93-12.00	85/100	Fg.-Nr. →V1999999	ERH,LLE	0 986 480 134	25,4			
					LLE	0 986 480 133	23,8			
					09.99-09.04	88/103-106		LLE	0 986 480 846	25,4
2.5 i		04.94-09.04	125	Fg.-Nr. W1000001→	LLE	0 986 480 846	25,4			
2.5 i, TD, TDI		04.94-09.04	96/125	Fg.-Nr. →V1999999	LLE	0 986 480 134	25,4			
2.5 TD, TDI		04.94-09.04	96	Fg.-Nr. W1000001→	LLE	0 986 480 846	25,4			
2.5 TDI		09.01-09.04	110			0 986 480 846	25,4			
2.6 i		09.00-09.04	132			0 986 480 846	25,4			
3.0 i		04.94-02.01	155	Fg.-Nr. →V1999999	LLE	0 986 480 134	25,4			
		04.94-02.01	155	Fg.-Nr. W1000001→	LLE	0 986 480 846	25,4			
3.2 i		09.00-09.04	160			0 986 480 846	25,4			
		09.93-12.00	74/85/100			0 986 486 036	19,05			
		09.99-09.04	88/103-106			0 986 486 036	19,05			
		04.94-09.04	96/110/125			0 986 486 036	19,05			
		09.00-09.04	132			0 986 486 036	19,05			
		04.94-02.01	155			0 986 486 036	19,05			
		09.00-09.04	160			0 986 486 036	19,05			
		09.97-08.00	74			0 265 216 473 ^B				
2.0 i		09.93-08.99	100	Fg.-Nr. W1000001→		0 265 216 473 ^B				
				Fg.-Nr. Y1000001→	TW	0 265 216 475 ^H				
		04.94-12.00	85	Fg.-Nr. W1000001→		0 265 216 473 ^B				
2.5 i		04.94-09.04	125	Fg.-Nr. W1000001→		0 265 220 449 ^F				
2.5 TD		04.94-02.01	96	Fg.-Nr. W1000001→		0 265 216 473 ^B				
2.5 TDI		04.96-09.04	96	Fg.-Nr. W1000001→		0 265 216 473 ^B				
				Fg.-Nr. Y1000001→	TW	0 265 216 475 ^H				
		MFD 09.01-09.04	110			0 265 202 513 ^J				
		OFD 09.01-09.04	110			0 265 220 645 ^J				



	2.6 i	MFD 09.00-09.04	132			0 265 202 513 ^J	
		OFD 09.00-09.04	132			0 265 220 645 ^J	
	3.0 i	04.94-02.01	155	Fg.-Nr. W1000001→		0 265 220 449 ^F	
	3.2 i	MFD 09.00-09.04	160			0 265 202 513 ^J	
		OFD 09.00-09.04	160			0 265 220 645 ^J	
	2.5 TDI	OFD 09.01-09.04	110		TEI	1 273 004 599 ^J	
	2.6 i	OFD 09.00-09.04	132		TEI	1 273 004 599 ^J	
	3.2 i	OFD 09.00-09.04	160		TEI	1 273 004 599 ^J	

Signum

	1.8 i	MFD 03.06-09.08	103		JBH,LLE	0 986 480 993	25,4
		OFD 05.03-02.05	90		JBH,RLE	0 986 480 837	
		03.06-09.08	103		JBH,LLE	0 986 480 858	25,4
	1.9 CDTI	MFD 04.04-09.08	74/88/110		JBH,LLE	0 986 480 993	25,4
					JBH,RLE	0 986 480 837	
		OFD 04.04-09.08	88/110		JBH,LLE	0 986 480 858	25,4
	2.0 DTI, Turbo	OFD 05.03-09.08	74/129		JBH,LLE	0 986 480 858	25,4
	2.0 Turbo	MFD 05.03-09.08	129		JBH,LLE	0 986 480 993	25,4
					JBH,RLE	0 986 480 837	
	2.2 Direct, DTI	OFD 05.03-09.08	86-92/114		JBH,LLE	0 986 480 858	25,4
	3.0 CDTI	MFD 09.05-09.08	130-135		JBH,LLE	0 986 480 993	25,4
					JBH,RLE	0 986 480 837	
		OFD 05.03-09.08	130-135		JBH,LLE	0 986 480 858	25,4
	3.2 i	OFD 05.03-09.05	155		JBH,LLE	0 986 480 858	25,4

	1.8 i	05.03-02.05	90		LLE	0 986 486 110	15,87
		03.06-09.08	103		LLE	0 986 486 110	15,87
	1.9 CDTI	04.04-09.08	74/88/110		LLE	0 986 486 110	15,87
	2.0 DTI, Turbo	05.03-09.08	74/129		LLE	0 986 486 110	15,87
	2.2 Direct, DTI	05.03-09.08	86-92/114		LLE	0 986 486 110	15,87
	2.8 V6 Turbo	08.05-09.08	169/184		LLE	0 986 486 110	15,87
	3.0 CDTI	05.03-09.08	130-135		LLE	0 986 486 110	15,87
	3.2 i	05.03-09.05	155		LLE	0 986 486 110	15,87

	1.8 i	05.03-02.05	90			0 986 486 588	31
		03.06-09.08	103		KGH,MG5	0 986 486 588	31
					LGH,MG5	0 986 486 579	34
	2.0 Turbo	05.03-09.08	129		LGH,MG5	0 986 486 579	34
	2.8 V6 Turbo	08.05-09.07	169		EAY	0 986 486 588	31
				Get.-Nr. F17	MG5	0 986 486 588	31
				Get.-Nr. F40	MG6	0 986 486 579	34
		09.05-09.08	184			0 986 486 579	34

Sintra

	2.2 i16V, TD	09.96-09.99	85/104		JBH,RLE	0 986 480 942	23,8
	3.0 iV6 24V	09.96-09.99	148		JBH,RLE	0 986 480 942	23,8

Tigra [A]

	1.4 i	ABO 09.94-08.99	66		JBH,LLE	0 986 480 130	20,6
		ABS 09.94-08.99	66		JBH,LLE	0 986 480 818	22
	1.6 i	ABO 09.94-08.99	78		JBH,LLE	0 986 480 130	20,6
		ABS 09.94-08.99	78		JBH,LLE	0 986 480 818	22





◀ VAUXHALL Tigma [A]

	1.4 i	09.94-08.99	66	Fg.-Nr. T3000001→	BO	0 265 216 410 ^B	
	1.6 i	09.94-08.99	78	Fg.-Nr. T3000001→	BO	0 265 216 410 ^B	

Tigma TwinTop [B]



	1.3 CDTI	MFD 06.04-03.09	51			0 204 123 637	23,8
		OFD 06.04-03.09	51			F 026 003 638	23,81
	1.4 i	MFD 06.04-12.09	66			0 204 123 637	23,8
		OFD 06.04-12.09	66			F 026 003 638	23,81
	1.8 i	MFD 06.04-12.09	92			0 204 123 637	23,8
		OFD 06.04-12.09	92			F 026 003 638	23,81

	1.3 CDTI	06.04-03.09	51			0 204 125 812	
	1.4 i	06.04-12.09	66			0 204 125 812	
	1.8 i	06.04-12.09	92			0 204 125 812	

	1.3 CDTI	06.04-03.09	51		EAY	0 986 486 588	31
	1.4 i	06.04-12.09	66		EAY	0 986 486 588	31
	1.8 i	06.04-12.09	92		EAY	0 986 486 588	31

	1.3 CDTI	06.04-03.09	51			0 265 232 215 ^B	
				Fg.-Nr. →5E999999		0 265 234 340 ^T	
				Fg.-Nr. 6E000001→		0 265 234 340 ^T	
	1.4 i	06.04-12.09	66			0 265 232 213 ^B	
					EAY	0 265 231 444 ^B	
					GS	0 265 231 307 ^B	
				Fg.-Nr. →5E999999		0 265 234 340 ^T	
	1.8 i	06.04-12.09	92			0 265 234 340 ^T	
				Fg.-Nr. 6E000001→		0 265 234 340 ^T	
				Fg.-Nr. →5E999999		0 265 234 340 ^T	
				Fg.-Nr. 6E000001→		0 265 234 340 ^T	











	1.3 CDTI	06.04-03.09	51			0 265 005 270	
	1.4 i	06.04-12.09	66			0 265 005 270	
	1.8 i	06.04-12.09	92			0 265 005 270	

	1.3 CDTI	06.04-03.09	51			0 265 005 303	
	1.4 i	06.04-12.09	66			0 265 005 303	
	1.8 i	06.04-12.09	92			0 265 005 303	













Vectra [B]



	1.6 i	09.95-08.00	55/74	Fg.-Nr. →W1285446, →W5276825, →W7154258	JBH,LLE	0 986 480 684	22,2
	1.6 i 16V			Fg.-Nr. →W7999999, XL000001→	JBH,RLE	0 986 480 684	22,2
				Fg.-Nr. W1285447→ W1999999, W7154259→W5999999, XL000001→	JBH,LLE	0 986 480 010	20,64
		09.95-08.01	55/74	Fg.-Nr. X1000001→, X7000001→	JBH,LLE	0 986 480 493	20,64
	1.7 TD	09.95-08.01	60	Fg.-Nr. →W1285446, →W5276825, →W7154258	JBH,LLE	0 986 480 684	22,2
Fg.-Nr. →W7999999, XL000001→				JBH,RLE	0 986 480 684	22,2	
Fg.-Nr. W1285447→ W1999999, W7154259→W5999999, XL000001→				JBH,LLE	0 986 480 010	20,64	

		S							
1.7 TD		09.95-08.01	60	Fg.-Nr. X1000001→, X7000001→	JBH, LLE		0 986 480 493	20,64	
1.8 i 16V		09.95-08.99	85	Fg.-Nr. →W1285446, →W5276825, →W7154258	JBH, LLE		0 986 480 684	22,2	
				Fg.-Nr. →W7999999, XL000001→	JBH, RLE		0 986 480 684	22,2	
				Fg.-Nr. W1285447→ W1999999, W7154259→ W5999999, XL000001→	JBH, LLE		0 986 480 010	20,64	
		09.00-08.01	92	Fg.-Nr. X1000001→, X7000001→	JBH, LLE		0 986 480 493	20,64	
		03.01-08.01	81		JBH, LLE		0 986 480 493	20,64	
2.0 Di		09.95-08.01	60/74/82	Fg.-Nr. →W1285446, →W5276825, →W7154258	JBH, LLE		0 986 480 684	22,2	
2.0 DTI				Fg.-Nr. →W7999999, XL000001→	JBH, RLE		0 986 480 684	22,2	
2.0 i				Fg.-Nr. W1285447→ W1999999, W7154259→ W5999999, XL000001→	JBH, LLE		0 986 480 010	20,64	
				Fg.-Nr. X1000001→, X7000001→	JBH, LLE		0 986 480 493	20,64	
2.0 i		09.95-09.02	100		HWL, JBH		0 986 480 929	22,2	
2.0 i 16V				Fg.-Nr. →W1285446, →W5276825, →W7154258	JBH, LLE		0 986 480 920	23,81	
				Fg.-Nr. W1285447→, W7154259→	JBH, RLE		0 986 480 929	22,2	
					JBH, LLE		0 986 480 493	20,64	
2.2 DTI		09.00-08.01	92		JBH, LLE		0 986 480 493	20,64	
2.2 i		10.99-08.01	106		HWL, JBH		0 986 480 929	22,2	
2.2 i 16V		09.00-08.01	108		JBH, LLE		0 986 480 493	20,64	
2.5 i V6		09.95-08.01	125-143		HWL, JBH		0 986 480 929	22,2	
				Fg.-Nr. →W1285446, →W5276825, →W7154258	JBH, LLE		0 986 480 920	23,81	
					JBH, RLE		0 986 480 929	22,2	
2.6 V6		09.00-08.01	130		HWL, JBH		0 986 480 929	22,2	
 1.6 i, i 16V		09.95-08.01	55/74	Fg.-Nr. W1285447→, W7154259→, XL470221→			0 986 486 095	15,87	
1.7 TD		09.95-08.01	60	Fg.-Nr. W1285447→, W7154259→			0 986 486 095	15,87	
1.8 i 16V		09.95-08.99	85	Fg.-Nr. W1285447→, W7154259→, XL470221→			0 986 486 095	15,87	
		09.98-08.99	85				0 986 486 095	15,87	
		09.00-08.01	92				0 986 486 095	15,87	
		03.01-08.01	81				0 986 486 095	15,87	
2.0 Di, DTI		09.96-08.01	60/74	Fg.-Nr. W1285447→, W7154259→			0 986 486 095	15,87	
2.0 i, i 16V		09.95-09.02	82/100	Fg.-Nr. W1285447→, W7154259→, XL470221→			0 986 486 095	15,87	
2.2 DTI		09.00-08.01	92				0 986 486 095	15,87	
2.2 i		10.99-08.01	106	Fg.-Nr. W1285447→, W7154259→, XL470221→			0 986 486 095	15,87	
2.2 i 16V		09.00-08.01	108				0 986 486 095	15,87	
2.5 i V6		09.95-08.01	125-143	Fg.-Nr. W1285447→, W7154259→, XL470221→			0 986 486 095	15,87	
2.6 V6		09.00-08.01	130	Fg.-Nr. W1285447→, W7154259→, XL470221→			0 986 486 095	15,87	
 1.6 i		09.95-08.00	55		F18		0 986 486 593	34	
		09.96-08.00	55		F23		0 986 486 586	34	
1.6 i 16V		09.95-08.01	74		F13		0 986 486 588	31	
					F23		0 986 486 586	34	
1.7 TD		09.95-08.01	60				0 986 486 593	34	

			S									
◀ VAUXHALL Vectra [B]												
	1.8 i 16V	09.95-08.99	85					F18	0986 486 593	34		
								F23	0986 486 586	34		
		09.98-08.99	85						F13	0986 486 588	31	
									F13	0986 486 588	31	
		09.00-08.01	92						F23	0986 486 586	34	
									F23	0986 486 586	34	
		03.01-08.01	81						F13	0986 486 588	31	
									F23	0986 486 586	34	
	2.0 DI	09.96-08.01	60/74						F18	0986 486 593	34	
									F23	0986 486 586	34	
2.0 DTI								F23	0986 486 586	34		
2.0 i	09.95-09.02	82/100							0986 486 593	34		
2.0 i 16V								F23	0986 486 586	34		
2.2 i	10.99-08.01	106							F18	0986 486 593	34	
									F23,HWL	0986 486 586	34	
	2.0 i	09.95-09.02	100						0 265 220 025 ^F			
									2.0 i 16V			
	2.2 i	10.99-08.01	106							0 265 220 458 ^F		
	2.2 i 16V	09.00-08.01	108						0 265 220 583 ^F			
	2.5 i V6	09.95-08.01	125-143							Fg.-Nr. →W1285446, →W5276825, →W7154258	0 265 220 025 ^F	
										Fg.-Nr. W1285447→, W7154259→, WP000001→	0 265 220 458 ^F	
	2.6 V6	09.00-08.01	130								0 265 220 583 ^F	
	Vectra [C]											
	1.6 i	MFD	09.01-07.05	74					JBH,LLE LUC	0986 480 993	25,4	
									JBH,RLE LUC	0986 480 837		
		OFD	09.01-07.05	74						JBH,LLE LUC	0986 480 858	25,4
										JBH,RLE LUC	0986 480 837	
	1.6 i GTS	MFD	01.06-10.08	74-77						JBH,LLE LUC	0986 480 993	25,4
										JBH,RLE LUC	0986 480 837	
		OFD	01.06-10.08	74-77						JBH,LLE LUC	0986 480 858	25,4
										JBH,RLE LUC	0986 480 837	
	1.8 Dualfuel	MFD	09.01-10.08	81-85/ 87-93/103						JBH,LLE LUC	0986 480 993	25,4
										JBH,RLE LUC	0986 480 837	
	1.8 i	OFD	09.01-10.08	81-85/87-93/103						JBH,LLE LUC	0986 480 858	25,4
										JBH,RLE LUC	0986 480 837	
	1.9 CDTI	MFD	04.04-10.08	74/88/110						JBH,LLE	0986 480 993	25,4
										JBH,RLE	0986 480 837	
		OFD	04.04-10.08	74/88/110						JBH,LLE	0986 480 858	25,4
										JBH,RLE	0986 480 837	
	2.0 DTI	MFD	04.02-09.05	74						JBH,LLE LUC	0986 480 993	25,4
										JBH,RLE LUC	0986 480 837	
		OFD	04.02-09.05	74						JBH,LLE LUC	0986 480 858	25,4
										JBH,RLE LUC	0986 480 837	
2.2 Direct	MFD	09.01-10.08	86-92/ 100-114						JBH,LLE LUC	0986 480 993	25,4	
2.2 DTI	MFD	09.01-10.08	86-92/ 100-114						JBH,LLE LUC	0986 480 993	25,4	
									JBH,RLE LUC	0986 480 837		
2.2 i	OFD	09.01-10.08	86-92/100-114						JBH,LLE LUC	0986 480 858	25,4	
									JBH,RLE LUC	0986 480 837		
3.0 CDTI	MFD	03.03-10.08	130-135						JBH,LLE LUC	0986 480 993	25,4	
									JBH,RLE LUC	0986 480 837		
	OFD	03.03-10.08	130-135						JBH,LLE LUC	0986 480 858	25,4	
									JBH,RLE LUC	0986 480 837		
3.2 i	MFD	08.02-09.05	155						JBH,LLE LUC	0986 480 993	25,4	
									JBH,RLE LUC	0986 480 837		
	OFD	08.02-09.05	155						JBH,LLE LUC	0986 480 858	25,4	
									JBH,RLE LUC	0986 480 837		
	1.6 i		09.01-07.05	74					LLE	0986 486 110	15,87	
	1.6 i GTS		01.06-10.08	74-77					LLE	0986 486 110	15,87	
	1.8 Dualfuel, i		09.01-10.08	81-85/87-93/103					LLE	0986 486 110	15,87	
	1.9 CDTI		04.04-10.08	74/88/110					LLE	0986 486 110	15,87	
	2.0 DTI, Turbo		04.02-10.08	74/129					LLE	0986 486 110	15,87	
	2.2 Direct, DTI, i		09.01-10.08	86-92/100-114					LLE	0986 486 110	15,87	
	2.8 GTS Turbo, Turbo		09.05-10.08	169/184-188/206					LLE	0986 486 110	15,87	

									
3.0 CDTI		03.03-10.08	130-135			LLE	0 986 486 110	15,87	
3.2i		08.02-09.05	155			LLE	0 986 486 110	15,87	
 1.6i		09.01-07.05	74			F13	0 986 486 588	31	
1.6i GTS		01.06-10.08	74-77			F13	0 986 486 588	31	
1.8 Dualfuel, i		09.01-10.08	81-85/87-93/103			F13	0 986 486 588	31	
1.9 CDTI		04.04-10.08	74/88/110			F13	0 986 486 588	31	
2.0 DTI, Turbo		04.02-10.08	74/129			F13	0 986 486 588	31	
2.2 Direct, DTI, i		09.01-10.08	86-92/100-114			F13	0 986 486 588	31	
3.0 CDTI		03.03-10.08	130-135			F13	0 986 486 588	31	
Vectra Estate [B]									
									
 1.6i 16V		09.95-08.00	55/74	Fg.-Nr. →W1285446, →W5276825, →W7154258		JBH,LLE	0 986 480 684	22,2	
				Fg.-Nr. →W7999999, XL000001→		JBH,RLE	0 986 480 684	22,2	
				Fg.-Nr. W1285447→ W1999999, W7154259→ W5999999, XL000001→		JBH,LLE	0 986 480 010	20,64	
		09.95-08.01	55/74	Fg.-Nr. X1000001→, X7000001→		JBH,LLE	0 986 480 493	20,64	
1.7 TD		09.95-08.01	60	Fg.-Nr. →W1285446, →W5276825, →W7154258		JBH,LLE	0 986 480 684	22,2	
				Fg.-Nr. →W7999999, XL000001→		JBH,RLE	0 986 480 684	22,2	
				Fg.-Nr. W1285447→ W1999999, W7154259→ W5999999, XL000001→		JBH,LLE	0 986 480 010	20,64	
				Fg.-Nr. X1000001→, X7000001→		JBH,LLE	0 986 480 493	20,64	
1.8i 16V		09.95-08.99	85	Fg.-Nr. →W1285446, →W5276825, →W7154258		JBH,LLE	0 986 480 684	22,2	
				Fg.-Nr. →W7999999, XL000001→		JBH,RLE	0 986 480 684	22,2	
				Fg.-Nr. W1285447→ W1999999, W7154259→ W5999999, XL000001→		JBH,LLE	0 986 480 010	20,64	
				Fg.-Nr. X1000001→, X7000001→		JBH,LLE	0 986 480 493	20,64	
		09.00-08.01	92	Fg.-Nr. X1000001→, X7000001→		JBH,LLE	0 986 480 493	20,64	
		03.01-08.01	81			JBH,LLE	0 986 480 493	20,64	
2.0 DI		09.96-08.00	60/74	Fg.-Nr. →W1285446, →W5276825, →W7154258		JBH,LLE	0 986 480 684	22,2	
2.0 DTI				Fg.-Nr. →W7999999, XL000001→		JBH,RLE	0 986 480 684	22,2	
				Fg.-Nr. W1285447→ W1999999, W7154259→ W5999999, XL000001→		JBH,LLE	0 986 480 010	20,64	
		09.96-08.01	60/74	Fg.-Nr. X1000001→, X7000001→		JBH,LLE	0 986 480 493	20,64	
2.0i 16V		09.95-08.01	100			HWL,JBH	0 986 480 929	22,2	
				Fg.-Nr. →W1285446, →W5276825, →W7154258		JBH,LLE	0 986 480 920	23,81	
				Fg.-Nr. W1285447→, W7154259→		JBH,RLE	0 986 480 929	22,2	
						JBH,LLE	0 986 480 493	20,64	
2.2 DTI, i 16V		09.00-08.01	92/108			JBH,LLE	0 986 480 493	20,64	
2.5i V6		09.95-08.01	125-143			HWL,JBH	0 986 480 929	22,2	
				Fg.-Nr. →W1285446, →W5276825, →W7154258		JBH,LLE	0 986 480 920	23,81	
						JBH,RLE	0 986 480 929	22,2	
2.6 V6		09.00-08.01	130			HWL,JBH	0 986 480 929	22,2	





◀ VAUXHALL Vectra Estate [B]













	1.6 i 16V	09.95-08.01	55/74	Fg.-Nr. W1285447→, W7154259→, XL470221→	0 986 486 095	15,87
	1.7 TD	09.95-08.01	60	Fg.-Nr. W1285447→, W7154259→	0 986 486 095	15,87
	1.8 i 16V	09.95-08.99	85	Fg.-Nr. W1285447→, W7154259→, XL470221→	0 986 486 095	15,87
		09.98-08.99	85		0 986 486 095	15,87
		09.00-08.01	92		0 986 486 095	15,87
		03.01-08.01	81		0 986 486 095	15,87
	2.0 DI, DTI	09.96-08.01	60/74	Fg.-Nr. W1285447→, W7154259→	0 986 486 095	15,87
	2.0 i 16V	09.95-08.01	100	Fg.-Nr. W1285447→, W7154259→, XL470221→	0 986 486 095	15,87
	2.2 DTI, i 16V	09.00-08.01	92/108		0 986 486 095	15,87
	2.5 i V6	09.95-08.01	125-143	Fg.-Nr. W1285447→, W7154259→, XL470221→	0 986 486 095	15,87
2.6 V6	09.00-08.01	130	Fg.-Nr. W1285447→, W7154259→, XL470221→	0 986 486 095	15,87	

	1.6 i 16V	09.95-08.00	55	F18	0 986 486 593	34	
				F23	0 986 486 586	34	
		09.95-08.01	74	F13	0 986 486 588	31	
				F23	0 986 486 586	34	
			09.96-08.00	55	F13	0 986 486 588	31
	1.7 TD	09.95-08.01	60		0 986 486 593	34	
	1.8 i 16V	09.95-08.99	85	F18	0 986 486 593	34	
				F23	0 986 486 586	34	
		09.98-08.99	85	F13	0 986 486 588	31	
		09.00-08.01	92	F13	0 986 486 588	31	
				F23	0 986 486 586	34	
			03.01-08.01	81	F13	0 986 486 588	31
					F23	0 986 486 586	34
	2.0 DI	09.96-08.01	60/74	F18	0 986 486 593	34	
	2.0 DTI			F23	0 986 486 586	34	
2.0 i 16V	09.95-08.01	100		0 986 486 593	34		
			F23	0 986 486 586	34		

	2.0 i 16V	09.95-08.01	100	Fg.-Nr. →W1285446, →W5276825, →W7154258	0 265 220 025 ^F	
				Fg.-Nr. W1285447→, W7154259→, WP000001→	0 265 220 458 ^F	
	2.2 i 16V	09.00-08.01	108		0 265 220 583 ^F	
	2.5 i V6	09.95-08.01	125-143	Fg.-Nr. →W1285446, →W5276825, →W7154258	0 265 220 025 ^F	
				Fg.-Nr. W1285447→, W7154259→, WP000001→	0 265 220 458 ^F	
2.6 V6	09.00-08.01	130		0 265 220 583 ^F		

Vectra Estate [C]

	1.6 i	MFD	09.03-05.04	74	JBH,LLE LUC	0 986 480 993	25,4	
			07.04-10.08	74-77	JBH,RLE LUC	0 986 480 837		
						JBH,LLE LUC	0 986 480 993	25,4
						JBH,RLE LUC	0 986 480 837	
		OFD	09.03-05.04	74	JBH,LLE LUC	0 986 480 858	25,4	
			07.04-10.08	74-77	JBH,LLE LUC	0 986 480 858	25,4	
	1.8 i	MFD	09.03-08.05	81/90	JBH,LLE LUC	0 986 480 993	25,4	
					JBH,RLE LUC	0 986 480 837		
				01.06-10.08	103	JBH,LLE LUC	0 986 480 993	25,4
						JBH,RLE LUC	0 986 480 837	
		OFD	09.03-08.05	81/90	JBH,LLE LUC	0 986 480 858	25,4	
			01.06-10.08	103	JBH,LLE LUC	0 986 480 858	25,4	

										
1.9 CDTI	MFD 04.04-10.08	74/88/110				JBH,LLE	0 986 480 993	25,4		
						JBH,RLE	0 986 480 837			
	OFD 04.04-10.08	74/88/110				JBH,LLE	0 986 480 858	25,4		
2.0 DTI	MFD 09.03-10.08	74/129				JBH,LLE LUC	0 986 480 993	25,4		
2.0 Turbo						JBH,RLE LUC	0 986 480 837			
	OFD 09.03-10.08	74/129				JBH,LLE LUC	0 986 480 858	25,4		
2.2 Direct	MFD 09.03-10.08	86-92/				JBH,LLE LUC	0 986 480 993	25,4		
2.2 DTI		100-114				JBH,RLE LUC	0 986 480 837			
2.2 i	OFD 09.03-10.08	86-92/100-114				JBH,LLE LUC	0 986 480 858	25,4		
3.0 CDTI	MFD 09.03-10.08	130-135				JBH,LLE LUC	0 986 480 993	25,4		
						JBH,RLE LUC	0 986 480 837			
	OFD 09.03-10.08	130-135				JBH,LLE LUC	0 986 480 858	25,4		
3.2 i	MFD 09.03-09.05	155				JBH,LLE LUC	0 986 480 993	25,4		
						JBH,RLE LUC	0 986 480 837			
	OFD 09.03-09.05	155				JBH,LLE LUC	0 986 480 858	25,4		
 1.6 i	09.03-05.04	74				LLE	0 986 486 110	15,87		
	07.04-10.08	74-77				LLE	0 986 486 110	15,87		
1.8 i	09.03-08.05	81/90				LLE	0 986 486 110	15,87		
	01.06-10.08	103				LLE	0 986 486 110	15,87		
1.9 CDTI	04.04-10.08	74/88/110				LLE	0 986 486 110	15,87		
2.0 DTI, Turbo	09.03-10.08	74/129				LLE	0 986 486 110	15,87		
2.2 Direct, DTI, i	09.03-10.08	86-92/100-114				LLE	0 986 486 110	15,87		
2.8 GTS Turbo, Turbo	09.05-10.08	169/184-188/206				LLE	0 986 486 110	15,87		
3.0 CDTI	09.03-10.08	130-135				LLE	0 986 486 110	15,87		
3.2 i	09.03-09.05	155				LLE	0 986 486 110	15,87		
 1.6 i	09.03-05.04	74				F13	0 986 486 588	31		
	07.04-10.08	74-77				F13	0 986 486 588	31		
1.8 i	09.03-08.05	81/90				F13	0 986 486 588	31		
	01.06-10.08	103				F13	0 986 486 588	31		
1.9 CDTI	04.04-10.08	74/88/110				F13	0 986 486 588	31		
2.0 DTI, Turbo	09.03-10.08	74/129				F13	0 986 486 588	31		
2.2 Direct, DTI, i	09.03-10.08	86-92/100-114				F13	0 986 486 588	31		
3.0 CDTI	09.03-10.08	130-135				F13	0 986 486 588	31		
3.2 i	09.03-09.05	155				F13	0 986 486 588	31		
Vivaro										
										
 1.9 DI	03.01-08.06	59-60/74				JBH,LLE	0 986 480 887	20,6		
						JBH,RLE	0 986 480 831	25,4		
1.9 DTI										
	2.0 CDTI	ABO 08.06→	66/84				0 986 481 052	20,6		
		ABS, 08.06→	66/84				0 986 481 050	20,6		
	OAS									
	ASR 08.06→	66/84					0 986 481 051	20,6		
2.0 16V	ABO 03.01→	86-88	Fg.-Nr. 7V600001→, 7Y000001→				0 986 481 052	20,6		
	ABS, 03.01→	86-88	Fg.-Nr. 7V600001→, 7Y000001→				0 986 481 051	20,6		
	OAS									
	ASR 03.01→	86-88	Fg.-Nr. →6V699999	JBH			0 986 480 827	25,4		
				Fg.-Nr. 7V600001→, 7Y000001→				0 986 481 050	20,6	
	OAS 03.01→	86-88	Fg.-Nr. →4V602167	JBH			0 986 480 831	25,4		
			Fg.-Nr. 4V602168→	JBH			0 986 480 828	25,4		
			6V699999							
2.5 CDTI	ABO 08.06→	84/107					0 986 481 052	20,6		
	ABS, 08.06→	107					0 986 481 050	20,6		
	OAS 09.06-06.08	84					0 986 481 050	20,6		
				Fg.-Nr. 7V600001→, 7Y000001→				0 986 481 051	20,6	
	ASR 08.06→	107					0 986 481 051	20,6		
	09.06-06.08	84	Fg.-Nr. →6V699999	JBH			0 986 480 827	25,4		

		S								
VAUXHALL Vivaro										
	2.5 DTI	MFD	04.04-08.06	99			JBH	0 986 480 827	25,4	
		OFD	04.04-08.06	99			JBH	0 986 480 831	25,4	
							JBH	0 986 480 828	25,4	
							Fg.-Nr. →4V602167			
							Fg.-Nr. 4V602168→			
	1.9 DI, DTI		03.01-08.06	59-60/74			LLE	0 986 486 147	15,87	
	2.0 CDTI		08.06→	66/84			LLE	0 986 486 147	15,87	
							LLE	0 986 486 147	15,87	
							Fg.-Nr. →6V999999, →6Y999999			
							Fg.-Nr. 7V000001→, 7Y000001→			
				12.10→	66/84			LLE	0 986 486 147	15,87
	2.0 16V		03.01→	86-88				LLE	0 986 486 147	15,87
								LLE	0 986 486 147	15,87
								Fg.-Nr. →6V999999, →6Y999999		
								Fg.-Nr. 7V000001→, 7Y000001→		
2.5 CDTI		08.06→	107				LLE	0 986 486 147	15,87	
							LLE	0 986 486 147	15,87	
							LLE	0 986 486 147	15,87	
			09.06-06.08	84			LLE	0 986 486 147	15,87	
							LLE	0 986 486 147	15,87	
							LLE	0 986 486 147	15,87	
	2.5 DTI		04.04-08.06	99			LLE	0 986 486 147	15,87	
Zafira [A]										
	1.6 i, i CNG, i Dualfuel	MFD	09.98-06.05	69-73/74			JBH	0 986 481 028	23,81	
		OFD	09.98-06.05	69-73/74			JBH	0 986 480 699	23,8	
	1.8 i	MFD	03.99-06.05	85/92				JBH	0 986 481 028	23,81
		OFD	03.99-06.05	85/92				JBH	0 986 480 699	23,8
	2.0 DI, DTI		03.99-06.05	60/74			JBH	0 986 480 699	23,8	
	2.0 DI, DTI, Turbo		MFD	03.99-06.05	60/74/141			JBH	0 986 481 028	23,81
	2.0 Turbo		OFD	09.01-06.05	141			4SB, JBH	0 986 480 699	23,8
	2.2		MFD	09.00-06.05	92/108			JBH	0 986 481 028	23,81
	2.2 DTI		OFD	09.00-06.05	92/108			JBH	0 986 480 699	23,8
		1.6 i, i Dualfuel		09.98-06.05	74			LLE	0 986 486 063	15,87
1.8 i, i Dualfuel			03.99-06.05	85/92			LLE	0 986 486 063	15,87	
2.0 DI, DTI, Turbo			03.99-06.05	60/74/141			LLE	0 986 486 063	15,87	
2.2			09.00-06.05	108			LLE	0 986 486 063	15,87	
	1.6 i		09.98-06.05	74			F13	0 986 486 588	31	
							F23	0 986 486 586	34	
	1.6 i Dualfuel		09.99-06.05	74			F13	0 986 486 588	31	
	1.8 i		03.99-06.05	85/92				F13	0 986 486 588	31
								F23	0 986 486 586	34
	1.8 i Dualfuel		09.00-06.05	85/92			F13	0 986 486 588	31	
	2.0 DI		03.99-06.05	60/74			F18	0 986 486 593	34	
	2.0 DTI						F23	0 986 486 586	34	
	2.2		09.00-06.05	108				F18	0 986 486 593	34
								F23	0 986 486 586	34
	1.6 i		OFD	09.98-06.05	74			0 265 216 652 ^B		
	1.6 i Dualfuel			09.99-06.05	74			0 265 216 652 ^B		
	1.8 i			03.99-09.00	85			0 265 216 652 ^B		
					09.00-06.05	92		Fg.-Nr. 3H000001→	0 265 202 509 ^T	
				MFD	03.99-09.00	85			0 265 202 458 ^B	
				OFD	03.99-09.00	85			0 265 220 532 ^F	
	1.8 i Dualfuel		09.00-06.05	92				Fg.-Nr. →12999999, →1H999999	0 265 220 585 ^B	
								Fg.-Nr. 3H000001→	0 265 202 509 ^T	

1.8 i		09.00-06.05	92	Fg.-Nr. 2H000001→		0 265 220 637 ^F		
1.8 i Dualfuel				Fg.-Nr. 2H000001→2H999999		0 265 202 492 ^T		
2.0 DI, DTI	OFD	03.99-06.05	60/74			0 265 216 652 ^B		
2.0 Turbo		09.01-06.05	141	Fg.-Nr. →12999999, →1H999999		0 265 220 585 ^B		
				Fg.-Nr. 2H000001→		0 265 220 637 ^F		
				Fg.-Nr. 2H000001→2H999999		0 265 202 492 ^T		
				Fg.-Nr. 3H000001→		0 265 202 509 ^T		
2.2		09.00-06.05	108	Fg.-Nr. →12999999, →1H999999		0 265 220 585 ^B		
				Fg.-Nr. 2H000001→		0 265 220 637 ^F		
				Fg.-Nr. 2H000001→2H999999		0 265 202 492 ^T		
				Fg.-Nr. 3H000001→		0 265 202 509 ^T		
1.6 i		09.98-06.05	74	Fg.-Nr. →12999999, →1H999999		0 265 005 262		
				Fg.-Nr. 22000001→, 2B000001→, 2H000001→		0 265 005 262		
1.6 i CNG		09.01-06.05	69-73	Fg.-Nr. 22000001→, 2B000001→, 2H000001→		0 265 005 262		
1.6 i Dualfuel		09.99-06.05	74	Fg.-Nr. →12999999, →1H999999		0 265 005 262		
1.8 i		03.99-09.00	85	Fg.-Nr. →12999999, →1H999999		0 265 005 262		
				Fg.-Nr. 22000001→, 2B000001→, 2H000001→		0 265 005 262		
1.8 i, i Dualfuel		09.00-06.05	92			0 265 005 262		
2.0 DI		03.99-06.05	60/74	Fg.-Nr. →12999999, →1H999999		0 265 005 262		
2.0 DTI				Fg.-Nr. 22000001→, 2B000001→, 2H000001→		0 265 005 262		
2.0 Turbo		09.01-06.05	141			0 265 005 262		
2.2		09.00-06.05	108			0 265 005 262		
2.2 DTI		03.02-06.05	92	Fg.-Nr. 22000001→, 2B000001→, 2H000001→		0 265 005 262		
1.6 i		09.98-06.05	74	Fg.-Nr. →12999999, TW →1H999999		0 265 005 434		
				Fg.-Nr. 22000001→, 2H000001→		0 265 005 435		
1.6 i CNG		09.01-06.05	69-73	Fg.-Nr. 22000001→, 2H000001→		0 265 005 435		
1.8 i		03.99-09.00	85	Fg.-Nr. →12999999, TW →1H999999		0 265 005 434		
				Fg.-Nr. 22000001→, 2H000001→		0 265 005 435		
1.8 i, i Dualfuel		09.00-06.05	92			0 265 005 435		
2.0 DI		03.99-06.05	60/74	Fg.-Nr. →12999999, TW →1H999999		0 265 005 434		
2.0 DTI				Fg.-Nr. 22000001→, 2H000001→		0 265 005 435		
2.0 Turbo		09.01-06.05	141			0 265 005 435		
2.2		09.00-06.05	108			0 265 005 435		
2.2 DTI		03.02-06.05	92	Fg.-Nr. 22000001→, 2H000001→		0 265 005 435		
1.8 i, i Dualfuel		09.00-06.05	92			0 265 005 303		
2.0 Turbo		09.01-06.05	141			0 265 005 303		
2.2		09.00-06.05	108			0 265 005 303		
Zafira [B]								
1.6 i		03.07-01.15	83/85		RLE	0 986 481 059	25,4	
1.8 i, LPG		03.10-01.15	101-103		RLE	0 986 481 059	25,4	
2.0 i Turbo		07.05-12.10	147/177	Fg.-Nr. →62999999, →6G999999	JBH,RLE	0 986 480 856	25,4	
				Fg.-Nr. 72000001→, 7G000001→	RLE	0 986 481 059	25,4	
1.6 CNG, CNG Turbo, i		07.05-01.15	69-71/77/83/85/110		LLE	0 986 486 063	15,87	
1.7 CDTI		03.08-01.15	81/92		LLE	0 986 486 063	15,87	
1.8 i, LPG		07.05-01.15	88/101-103		LLE	0 986 486 063	15,87	



		S							
	◀ VAUXHALL Zafira [B]								
	1.9 CDTI	07.05-12.10	74/88/110			LLE	0986 486 063	15,87	
	2.0 i Turbo	07.05-12.10	147/177			LLE	0986 486 063	15,87	
	2.2 i Direkt	07.05-12.10	110			LLE	0986 486 063	15,87	
	1.6 CNG Turbo	03.09-01.15	110			EAY	0986 486 588	31	
						MG5	0986 486 588	31	
						MG6	0986 486 591	34	
	1.6 CNG, i	07.05-01.15	69-71/77/83/85				0986 486 588	31	
	1.7 CDTI	03.08-07.12	81				0986 486 588	31	
		03.08-01.15	81			EAY, MG5	0986 486 588	31	
						MG6	0986 486 594	34	
			92			EAY, MG5	0986 486 588	31	
						MG6	0986 486 594	34	
	1.8 i, LPG	07.05-01.15	88/101-103				0986 486 588	31	
	1.9 CDTI	07.05-12.10	74/88/110			TW	0986 486 588	31	
							0986 486 590	34	
	2.0 i Turbo	07.05-12.10	147			EAY, MG5	0986 486 588	31	
						Get.-Nr. M32	MG6	0986 486 591	34
		09.05-12.10	177			EAY	0986 486 588	31	
						Get.-Nr. F17	MG5	0986 486 588	31
						Get.-Nr. M32	MG6	0986 486 590	34
	2.2 i Direkt	07.05-12.10	110			EAY, MG5	0986 486 588	31	
						Get.-Nr. M32	MG6	0986 486 591	34

VOLVO

C30 [P14]

















	1.6, D DRiVe	10.06-07.12	74/80			LLE	0986 486 150	19,05	
	1.8, F Flexifuel	10.06-07.10	92			LLE	0986 486 150	19,05	
	2.0, D	10.06->	100/107			LLE	0986 486 150	19,05	

	1.6	10.06-07.12	74				0986 486 611	28	
--	-----	-------------	----	--	--	--	--------------	----	--

S40 I

















	1.6 16V	01.97-07.97	77				0 204 123 198	22,22	
		08.97-07.99	77			JBH	F 026 003 405	23,81	
		08.99-01.04	80			JBH	F 026 003 405	23,81	
	1.8 16V	09.95-07.97	85				0 204 123 198	22,22	
		08.97-07.99	85			JBH	F 026 003 405	23,81	
		09.97-01.04	90/92			JBH	F 026 003 405	23,81	
	1.9 D	05.96-07.97	66				0 204 123 198	22,22	
		08.97-07.99	66			JBH	F 026 003 405	23,81	
		03.98-01.04	70/75/85			JBH	F 026 003 405	23,81	
	1.9 T4	05.97-07.97	147				0 204 123 198	22,22	
		08.97-07.00	147			JBH	F 026 003 405	23,81	
	2.0 T, T 16V, T4	04.98-01.04	118/120/121/147			JBH	F 026 003 405	23,81	
	2.0 16V	09.95-07.97	103				0 204 123 198	22,22	
		08.97-07.99	103			JBH	F 026 003 405	23,81	
		08.99-01.04	100			JBH	F 026 003 405	23,81	











































	1.6 16V	01.97-07.97	77				0 204 125 132		
		08.97-07.99	77				0 204 125 576		
		08.99-01.04	80				0 204 125 576		
	1.8 16V	09.95-07.97	85				0 204 125 132		
		08.97-07.99	85				0 204 125 576		
		09.97-01.04	90/92				0 204 125 576		

		S							
1.9 D		05.96-07.97	66				0 204 125 132		
		08.97-07.99	66				0 204 125 576		
		03.98-01.04	70/75/85				0 204 125 576		
1.9 T4		05.97-07.97	147				0 204 125 132		
		08.97-07.00	147				0 204 125 576		
2.0 T, T 16V, T4		04.98-01.04	118/120/121/147				0 204 125 576		
2.0 16V		09.95-07.97	103				0 204 125 132		
		08.97-07.99	103				0 204 125 576		
		08.99-01.04	100				0 204 125 576		
 1.6 16V		01.97-07.97	77				0 265 216 045 ^B		
		08.97-07.99	77				0 265 216 463 ^B		
		08.99-01.04	80				0 265 216 463 ^B		
1.8 16V		09.95-07.97	85				0 265 216 045 ^B		
		08.97-07.99	85				0 265 216 463 ^B		
		09.97-01.04	90/92				0 265 216 463 ^B		
1.9 D		05.96-07.97	66				0 265 216 045 ^B		
		08.97-07.99	66				0 265 216 463 ^B		
		03.98-01.04	70/75/85				0 265 216 463 ^B		
1.9 T4		05.97-07.97	147				0 265 216 045 ^B		
		08.97-07.00	147				0 265 216 463 ^B		
2.0 T, T 16V, T4		04.98-01.04	118/120/121/147				0 265 216 463 ^B		
2.0 16V		09.95-07.97	103				0 265 216 045 ^B		
		08.97-07.99	103				0 265 216 463 ^B		
		08.99-01.04	100				0 265 216 463 ^B		
S40 II [P11]									
									
 ↑	1.6, D DRIVE, D2	11.04-08.12	74/80-81/84		LLE		0 986 486 150	19,05	
	1.8, F Flexifuel	04.04-07.10	92		LLE		0 986 486 150	19,05	
	2.0, D	01.04-08.12	100/107		LLE		0 986 486 150	19,05	
 ↓	1.6	11.04-08.12	74				0 986 486 611	28	
S60 I									
									
	2.0 T	OFD 11.00-07.09	132	Fg.-Nr. 8536→626462	JBH,LLE		0 986 481 024	25,4	
	2.3 T5	OFD 11.00-03.04	147-195	Fg.-Nr. 8536→626462	JBH,LLE		0 986 481 024	25,4	
	2.4	OFD 11.00-07.09	85/90/93/	Fg.-Nr. 8536→626462	JBH,LLE		0 986 481 024	25,4	
	2.4 Bi-Fuel CNG, Bi-Fuel LPG, D, D5, T, T AWD, T5		96/103/120/123/125/132-162/191						
	2.5 T, T AWD	OFD 04.04-07.09	154	Fg.-Nr. 8536→626462	JBH,LLE		0 986 481 024	25,4	
S70									
									
 ↓	R 2.3 T, T AWD	01.97-07.98	177-184	Fg.-Nr. →459999	LLE		0 986 486 550	22	
	2.0	01.97-07.00	93/105/120/132/	Fg.-Nr. →459999	LLE		0 986 486 550	22	
	2.0 T		155						
	2.0 T 20V								
	2.3	01.97-07.98	160	Fg.-Nr. →459999	LLE		0 986 486 550	22	
	2.4	01.99-07.00	103/125/142	Fg.-Nr. →459999	LLE		0 986 486 550	22	
	2.4 AWD								
	2.5, Bifuel, T, T AWD, 20V	01.97-07.00	103/106/121/142	Fg.-Nr. →459999	LLE		0 986 486 550	22	

























			S							
◀ VOLVO										
S80 I										
	2.0 T	OFD	08.98-07.06	120/132/165/166	Fg.-Nr. 174096→		JBH, LLE	0986 481 024	25,4	
	2.0 T5									
	2.3 R	OFD	04.00-07.05	147-195	Fg.-Nr. 174096→		JBH, LLE	0986 481 024	25,4	
	2.4, Bi-Fuel LPG, T4 Bi-Fuel CNG	OFD	08.98-07.06	103	Fg.-Nr. 174096→		JBH, LLE	0986 481 024	25,4	
	2.4, T, T AWD	OFD	08.98-07.06	125/132-162	Fg.-Nr. 174096→		JBH, LLE	0986 481 024	25,4	
	2.4 D	OFD	10.01-07.06	96			JBH, LLE	0986 481 024	25,4	
	2.4 D5	OFD	08.01-07.06	120			JBH, LLE	0986 481 024	25,4	
	2.5, AWD	OFD	08.03-07.06	154	Fg.-Nr. 174096→		JBH, LLE	0986 481 024	25,4	
	2.5 TDI	OFD	08.98-07.01	103	Fg.-Nr. 174096→		JBH, LLE	0986 481 024	25,4	
	2.8 T6	OFD	05.98-07.01	200	Fg.-Nr. 174096→		JBH, LLE	0986 481 024	25,4	
	2.9	OFD	06.98-07.01	147/150	Fg.-Nr. 174096→		JBH, LLE	0986 481 024	25,4	
	3.0, T6	OFD	08.01-07.06	144/200	Fg.-Nr. 174096→		JBH, LLE	0986 481 024	25,4	
S90										
	2.5		11.96-12.99	120-132				0986 480 894	20	
	2.9, Exekutive, Exekutive Plus		01.97-05.98	132/150				0986 480 894	20	
	2.5		11.96-12.99	120-132			BD1, BDM	0 204 125 663		
	2.9, Exekutive, Exekutive Plus		01.97-05.98	132/150			BD1, BDM	0 204 125 663		
V40 I										
	1.6 16V		01.97-07.97	77				0 204 123 198	22,22	
			08.97-07.99	77			JBH	F 026 003 405	23,81	
			08.99-04.04	80			JBH	F 026 003 405	23,81	
	1.8 16V		09.95-07.97	85				0 204 123 198	22,22	
			08.97-07.99	85			JBH	F 026 003 405	23,81	
			08.97-06.04	90/92			JBH	F 026 003 405	23,81	
	1.9 D		01.96-07.97	66				0 204 123 198	22,22	
			08.97-07.99	66			JBH	F 026 003 405	23,81	
			08.98-04.04	70/75/85			JBH	F 026 003 405	23,81	
	1.9 T4		05.97-07.97	147				0 204 123 198	22,22	
			08.97-07.00	147			JBH	F 026 003 405	23,81	
	2.0		01.96-07.97	103				0 204 123 198	22,22	
			08.97-07.99	103			JBH	F 026 003 405	23,81	
	2.0 T, T4 T, 16V T		04.98-04.04	118/120/121/147			JBH	F 026 003 405	23,81	
	2.0 16V		08.99-04.04	100			JBH	F 026 003 405	23,81	
	1.6 16V		01.97-07.97	77				0 204 125 132		
			08.97-07.99	77				0 204 125 576		
			08.99-04.04	80				0 204 125 576		
	1.8 16V		09.95-07.97	85				0 204 125 132		
			08.97-07.99	85				0 204 125 576		
			08.97-06.04	90/92				0 204 125 576		
	1.9 D		01.96-07.97	66				0 204 125 132		
			08.97-07.99	66				0 204 125 576		
			08.98-04.04	70/75/85				0 204 125 576		
	1.9 T4		05.97-07.97	147				0 204 125 132		
			08.97-07.00	147				0 204 125 576		
	2.0		01.96-07.97	103				0 204 125 132		
			08.97-07.99	103				0 204 125 576		
	2.0 T, T4 T, 16V T		04.98-04.04	118/120/121/147				0 204 125 576		
	2.0 16V		08.99-04.04	100				0 204 125 576		

		S							
	1.6 16V	01.97-07.97	77				0 265 216 045 ^B		
		08.97-07.99	77				0 265 216 463 ^B		
		08.99-04.04	80				0 265 216 463 ^B		
	1.8 16V	01.95-07.97	85				0 265 216 045 ^B		
		08.97-07.99	85				0 265 216 463 ^B		
		08.97-06.04	90/92				0 265 216 463 ^B		
	1.9 D	01.96-07.97	66				0 265 216 045 ^B		
		08.97-07.99	66				0 265 216 463 ^B		
		08.98-04.04	70/75/85				0 265 216 463 ^B		
	1.9 T4	05.97-07.97	147				0 265 216 045 ^B		
		08.97-07.00	147				0 265 216 463 ^B		
	2.0	01.96-07.97	103				0 265 216 045 ^B		
		08.97-07.99	103				0 265 216 463 ^B		
	2.0 T, T4 T, 16V T	04.98-04.04	118/120/121/147				0 265 216 463 ^B		
	2.0 16V	08.99-04.04	100				0 265 216 463 ^B		
V50 [P12]									
									
	1.6 D2 DRIVe	08.11-12.12	84			LLE	0 986 486 150	19,05	
	1.6	01.05-12.12	74				0 986 486 611	28	
V70 I									
									
	2.0	01.97-07.97	93/105			RLE	0 986 486 550	22	
		01.97-03.00	93/105	Fg.-Nr. →395001		LLE	0 986 486 550	22	
	2.0 AWD Turbo	01.97-07.99	166	Fg.-Nr. →395001		LLE	0 986 486 550	22	
	2.0 T 20V	08.98-03.00	120	Fg.-Nr. →395001		LLE	0 986 486 550	22	
	2.0 Turbo	01.97-07.97	132/155/166			RLE	0 986 486 550	22	
		01.97-03.00	132/155	Fg.-Nr. →395001		LLE	0 986 486 550	22	
	2.3	01.97-07.97	160/174-176/184			RLE	0 986 486 550	22	
	2.3 R	01.97-07.98	160/174-176/184	Fg.-Nr. →395001		LLE	0 986 486 550	22	
	2.3 AWD	12.98-03.00	184-195	Fg.-Nr. →395001		LLE	0 986 486 550	22	
	2.3 R AWD	08.97-07.98	160/174-176/184	Fg.-Nr. →395001		LLE	0 986 486 550	22	
	2.3 T-5 AWD	01.97-07.97	160/174-176/184			RLE	0 986 486 550	22	
		01.97-03.00	160/174-176/184	Fg.-Nr. →395001		LLE	0 986 486 550	22	
	2.4	05.99-03.00	103/125	Fg.-Nr. →395001		LLE	0 986 486 550	22	
	2.4 XC AWD	03.99-03.00	142	Fg.-Nr. →395001		LLE	0 986 486 550	22	
	2.5, T, T AWD, T XC, T XC AWD, 20V	01.97-07.97	106/121/142			RLE	0 986 486 550	22	
		01.97-03.00	106/121/142	Fg.-Nr. →395001		LLE	0 986 486 550	22	
	2.5 AWD	03.99-03.00	195	Fg.-Nr. →395001		LLE	0 986 486 550	22	
	2.5 BI-FUEL	08.97-03.00	103	Fg.-Nr. →395001		LLE	0 986 486 550	22	
	2.5 TDI	01.97-07.97	103			RLE	0 986 486 550	22	
		01.97-03.00	103	Fg.-Nr. →395001		LLE	0 986 486 550	22	
V70 II									
									
	2.0 T	OFD 03.00-07.07	132			JBH,LLE	0 986 481 024	25,4	
	2.3, T5	OFD 03.00-07.04	184/195			JBH,LLE	0 986 481 024	25,4	

		S							
VOLVO V70 II									
		2.4, D, D AWD, D5, D5 AWD	OFD 03.00-07.07	90/93/96/103/120/125/136		JBH, LLE	0986 481 024	25,4	
		2.4 T	OFD 03.00-07.03	147		JBH, LLE	0986 481 024	25,4	
		2.4 T AWD, XC AWD	OFD 09.00-07.03	147	Fg.-Nr. 11001→	JBH, LLE	0986 481 024	25,4	
		2.4 T5	OFD 04.04-07.07	191		JBH, LLE	0986 481 024	25,4	
		2.5 BI-FUEL CNG, BI-FUEL LPG	OFD 09.01-07.07	103		JBH, LLE	0986 481 024	25,4	
		2.5 D	OFD 03.00-07.01	103		JBH, LLE	0986 481 024	25,4	
		2.5 T, T AWD	OFD 08.02-07.07	154		JBH, LLE	0986 481 024	25,4	
V90									
									
		2.9	01.97-07.98	132/150			0986 480 894	20	
		2.9	01.97-07.98	132/150		BD8	0204 125 112		
XC70 I									
									
		2.3 T	OFD 08.02-07.04	140	Fg.-Nr. →270273	JBH, LLE	0986 481 024	25,4	
		2.4 D, D5, T	OFD 08.02-07.07	120/136/ 147-147	Fg.-Nr. →270273	JBH, LLE	0986 481 024	25,4	
		2.5 T	OFD 08.02-07.07	154	Fg.-Nr. →270273	JBH, LLE	0986 481 024	25,4	
440									
									
		1.6 i	ABO 09.88-07.97	61-69		LLE	0204 123 467	20,64	
		1.7 i	ABO 09.88-07.94	78-80		RLE	0204 123 462	20,6	
		1.8 i	ABO 09.88-07.97	66/88		LLE	0204 123 467	20,64	
		1.8 T				RLE	0204 123 462	20,6	
		1.9 D T	ABO 09.93-07.97	66		LLE	0204 123 467	20,64	
		2.0 i	ABO 09.92-12.96	80		RLE	0204 123 462	20,6	
									
460									
									
		1.6 i	ABO 03.90-07.97	61		LLE	0204 123 467	20,64	
		1.7, i, iT	ABO 03.90-07.97	66/78/88		RLE	0204 123 462	20,6	
		1.8 i	ABO 09.91-07.97	66		LLE	0204 123 467	20,64	
		1.9 D	ABO 09.93-07.97	66		RLE	0204 123 462	20,6	
		2.0 i	ABO 09.92-12.96	80		LLE	0204 123 467	20,64	
						RLE	0204 123 462	20,6	
480									
									
		1.7 iT	ABO 08.88-07.95	88-90		LLE	0204 123 467	20,64	
		2.0 i	ABO 09.92-12.96	81		RLE	0204 123 462	20,6	
						LLE	0204 123 467	20,64	
						RLE	0204 123 462	20,6	



									
740									
									
	2.0i	ABO	08.91-07.94	80-89			0 986 480 816	20,6	
	2.3i	ABO	08.88-07.95	83-85/94/96			0 986 480 816	20,6	
	2.0i		08.91-07.94	80-89		BD1	0 204 125 663		
		ABO	08.91-07.94	80-89	Fg.-Nr. 33720→	BD8	0 204 125 661		
		ABS	08.91-07.94	80-89		BD8	0 204 125 661		
	2.3i		08.91-07.95	94		BD1	0 204 125 663		
						BD8	0 204 125 661		
		ABO	08.88-07.94	83-85		BD1	0 204 125 663		
					Fg.-Nr. 33720→	BD8	0 204 125 661		
			08.88-07.95	85		BD1	0 204 125 663		
					Fg.-Nr. 33720→	BD8	0 204 125 661		
			08.89-07.95	96		BD1	0 204 125 663		
					Fg.-Nr. 33720→	BD8	0 204 125 661		
		ABS	08.91-07.94	83-85		BD1	0 204 125 663		
						BD8	0 204 125 661		
			08.91-07.95	85/96		BD1	0 204 125 663		
						BD8	0 204 125 661		
	2.0i		08.91-07.94	80-89			0 986 486 549	20,64	
	2.3i		08.88-07.95	83-85/94/96			0 986 486 549	20,64	
	2.0i		08.91-07.94	80-89			0 265 205 011 ^H		
	2.3i		08.91-07.95	83-85/94			0 265 205 011 ^H		
	2.3i		08.89-07.94	83-85			0 265 101 028 ^H		
850									
									
	2.0, Turbo		09.91-08.95	93/105/155		JBH	0 986 480 932	23,81	
	2.3 R, Turbo, T-5, T-5R		09.93-08.95	155/166-184		JBH	0 986 480 932	23,81	
	2.5 GLE, GLT		09.91-08.95	103-106/125		JBH	0 986 480 932	23,81	
	2.0, GLT, Turbo		09.91-07.97	93/105/129-132/155			0 986 486 550	22	
	2.3		09.97-07.98	120			0 986 486 550	22	
	2.3 Turbo, T-5, T-5R		09.93-07.97	155/166/177			0 986 486 550	22	
	2.5 AWD, GLE, GLT, TDI, Turbo		09.91-07.97	103-106/125/140-142			0 986 486 550	22	
850 Kombi									
									
	2.0, Turbo		03.92-08.95	93/105/155		JBH	0 986 480 932	23,81	
	2.3 R, T-5, T-5R		09.93-08.95	155/160/166/176-184		JBH	0 986 480 932	23,81	
	2.5 GLE, GLT		09.91-08.95	103-106/125		JBH	0 986 480 932	23,81	
	2.0, GLT, Turbo		03.92-07.97	93/105/129-132/155			0 986 486 550	22	
	2.3		09.97-07.98	120			0 986 486 550	22	
	2.3 T-5, T-5R		09.93-07.97	155/160/166/177			0 986 486 550	22	
	2.5 AWD, GLE, GLT, TDI, Turbo		09.91-07.97	103-106/125/140-142			0 986 486 550	22	
940									
									
	2.0, Turbo, Turbo Interc.		09.92-09.98	80-89/114			0 986 480 894	20	
	2.3, Turbo, Turbo Interc.		09.92-10.98	84/96-99/104/113-151			0 986 480 894	20	
	2.4 TD		09.92-07.97	90			0 986 480 894	20	



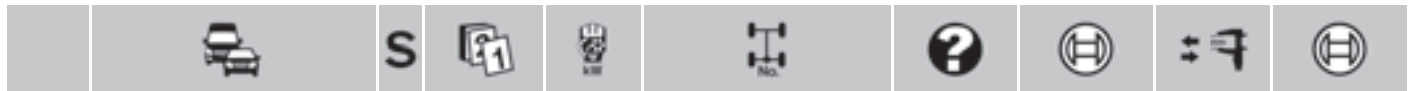

◀ VOLVO 940

	2.0, Turbo Interc.	ABS	09.91-08.94	80-89/114	BD8,BDM	0 204 125 661	
	2.0, Turbo, Turbo Interc.		09.94-09.98	82/114	BD8,BDM	0 204 125 112	
		ABO	09.91-09.98	80-89/114	BD1	0 204 125 663	
2.3			09.92-07.95	84	BD1	0 204 125 663	
			09.94-07.95	84	BD8,BDM	0 204 125 112	
				96-99	BD8,BDM	0 204 125 112	
2.3		ABO	09.90-10.98	96-99/104/118-151	BD1	0 204 125 663	
2.3 Turbo Interc.	ABS	09.91-08.94	84/96-99/104/118-151		BD8,BDM	0 204 125 661	
2.3 Turbo			09.94-07.98	99	BD1	0 204 125 663	
					BD8,BDM	0 204 125 112	
2.3 Turbo Interc.			09.94-07.97	104	BD8,BDM	0 204 125 112	
			09.94-10.98	118-151	BD8,BDM	0 204 125 112	
			05.95-07.97	121	BD1	0 204 125 663	
					BD8,BDM	0 204 125 112	
			06.95-07.97	113-121	BD1	0 204 125 663	
					BD8,BDM	0 204 125 112	
2.4 TD			09.94-07.97	90	BD8,BDM	0 204 125 112	
		ABO	09.90-07.97	90	BD1	0 204 125 663	
		ABS	09.91-08.94	90	BD8,BDM	0 204 125 661	

	2.0, Turbo, Turbo Interc.		09.91-09.98	80-89/114		0 265 205 011 ^H	
	2.3, Turbo, Turbo Interc.		09.91-10.98	84/96-99/104/113-151		0 265 205 011 ^H	
	2.4 TD		09.91-07.97	90		0 265 205 011 ^H	

	2.0, Turbo, Turbo Interc.		09.91-09.98	80-89/114	Fg.-Nr. → 124125, → 73705	0 265 101 028 ^H			
					Fg.-Nr. 124126→, 73706→	0 265 101 031 ^H			
	2.3		06.91-07.95	84/96-99	Fg.-Nr. → 124125, → 73705	0 265 101 028 ^H			
					Fg.-Nr. 124126→, 73706→	0 265 101 031 ^H			
	2.3 Turbo		09.94-07.98	99	Fg.-Nr. → 124125	0 265 101 028 ^H			
					Fg.-Nr. 124126→, 73706→	0 265 101 031 ^H			
	2.3 Turbo Interc.		09.90-10.98	118-151	Fg.-Nr. → 124125, → 73705	0 265 101 028 ^H			
					Fg.-Nr. 124126→, 73706→	0 265 101 031 ^H			
					09.91-07.97	104	Fg.-Nr. → 124125, → 73705	0 265 101 028 ^H	
							Fg.-Nr. 124126→, 73706→	0 265 101 031 ^H	
					05.95-07.97	121	Fg.-Nr. → 124125	0 265 101 028 ^H	
							Fg.-Nr. 124126→, 73706→	0 265 101 031 ^H	
	06.95-07.97	113-121	Fg.-Nr. → 124125	0 265 101 028 ^H					
			Fg.-Nr. 124126→, 73706→	0 265 101 031 ^H					
	2.4 TD		09.90-07.97	90	Fg.-Nr. → 124125, → 73705	0 265 101 028 ^H			
Fg.-Nr. 124126→, 73706→					0 265 101 031 ^H				

960



	2.0 T, T 16V		09.91-07.94	103/140		0 986 480 894	20
	2.3 T		09.91-07.97	125		0 986 480 894	20
	2.4, TD		08.91-07.97	85/120		0 986 480 894	20
	2.5		09.94-07.97	125		0 986 480 894	20
	3.0		08.91-07.98	150		0 986 480 894	20

	2.0 T, T 16V	ABS	09.91-07.94	103/140	BD8,BDM	0 204 125 661			
					BD1, BDM	0 204 125 663			
	2.3 T		09.94-07.97	125	BD8,BDM	0 204 125 112			
					ABS	09.91-08.94	125	BD8,BDM	0 204 125 661
	2.4		09.94-07.97	85/120	BD1, BDM	0 204 125 663			
	2.4 TD				BD8,BDM	0 204 125 112			
	2.4 TD	ABS	09.91-08.94	85	BD8,BDM	0 204 125 661			
	2.5		09.94-07.97	125	BD1, BDM	0 204 125 663			
					BD8,BDM	0 204 125 112			
	3.0		09.94-07.97	150	BD8,BDM	0 204 125 112			
					09.94-07.98	150	BD1, BDM	0 204 125 663	
					ABS	09.91-08.94	150	BD8,BDM	0 204 125 661



	2.0 T, T 16V	09.91-07.94	103/140		0 265 205 011 ^H	
	2.3 T	09.91-07.97	125		0 265 205 011 ^H	
	2.4, TD	09.91-07.97	85/120		0 265 205 011 ^H	
	2.5	09.94-07.97	125		0 265 205 011 ^H	
	3.0	09.91-07.97	150		0 265 205 011 ^H	
	2.0 T	09.91-07.94	103/140	Fg.-Nr. → 12664, → 32218	0 265 101 028 ^H	
	2.0 T 16V			Fg.-Nr. 12665 →, 32219 →	0 265 101 031 ^H	
	2.3 T	09.91-07.97	125	Fg.-Nr. → 12664, → 32218	0 265 101 028 ^H	
				Fg.-Nr. 12665 →, 32219 →	0 265 101 031 ^H	
	2.4	08.90-07.97	85/120	Fg.-Nr. → 12664, → 32218	0 265 101 028 ^H	
	2.4 TD			Fg.-Nr. 12665 →, 32219 →	0 265 101 031 ^H	
	2.5	09.94-07.97	125	Fg.-Nr. → 12664, → 32218	0 265 101 028 ^H	
				Fg.-Nr. 12665 →, 32219 →	0 265 101 031 ^H	
3.0	09.90-07.97	150	Fg.-Nr. → 12664, → 32218	0 265 101 028 ^H		
			Fg.-Nr. 12665 →, 32219 →	0 265 101 031 ^H		

VW (VOLKSWAGEN)

Beetle Cabriolet [5C7]

	1.2 TSI	01.13 →	77		0 986 486 554	19,05
	1.4 TSI	12.14 →	110		0 986 486 554	19,05
	2.0 TDI, TSI	01.13 →	103/147/155		0 986 486 595	29

Beetle [5C1]

	2.0 TSI	12.12 →	155	PR-Code 1ZD	JBH, LLE, TW	0 986 480 870	22
	1.2 TSI	07.11 →	77		0 986 486 554	19,05	
	1.4 TSI	12.14 →	110		0 986 486 554	19,05	
	1.6 TDI	10.11-07.12	77		0 986 486 576	19	
	2.0 TDI, TSI	04.11 →	103/147/155		0 986 486 595	29	

Bora Variant [1J6]

	1.4	MFD 05.00-05.05	55		JBH, LLE, M20	0 986 481 022	23,81
		OFD 05.00-05.05	55		LLE	F 026 003 339	23,81
					RLE	0 204 123 406	23,81
	1.6	MFD 05.99-05.05	74/75/77/81		JBH, LLE, M20	0 986 481 022	23,81
		OFD 05.99-05.05	74/75/77/81		LLE	F 026 003 339	23,81
					RLE	0 204 123 406	23,81
	1.6 FSI						
	1.8 T	MFD 05.99-05.05	92/110/132		JBH, LLE, M20	0 986 481 022	23,81
		OFD 05.99-05.05	92/110/132		LLE	F 026 003 339	23,81
					RLE	0 204 123 406	23,81
	1.8 4Motion						
	1.9 TDI	MFD 09.98-05.05	66/74/81/		JBH, LLE, M20	0 986 481 022	23,81
		OFD 09.98-05.05	66/74/81/		LLE	F 026 003 339	23,81
			85/96/110		RLE	0 204 123 406	23,81
	1.9 TDI 4Motion						
	2.0	MFD 05.99-05.05	85		JBH, LLE, M20	0 986 481 022	23,81
		OFD 05.99-05.05	85		LLE	F 026 003 339	23,81
					RLE	0 204 123 406	23,81
	2.0 4Motion						
	2.3	MFD 05.99-05.05	110/125		JBH, LLE, M20	0 986 481 022	23,81
		OFD 05.99-05.05	110/125		LLE	F 026 003 339	23,81
					RLE	0 204 123 406	23,81
	2.3 4Motion						
	2.8 4Motion	MFD 05.99-05.05	150		JBH, LLE, M20	0 986 481 022	23,81
		OFD 05.99-05.05	150		LLE	F 026 003 339	23,81
					RLE	0 204 123 406	23,81



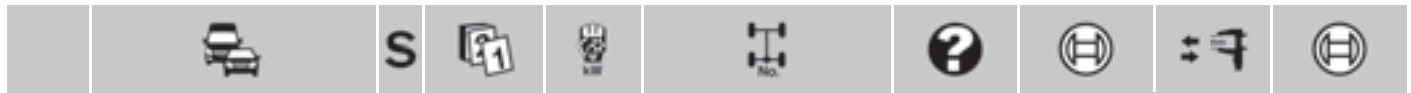

◀ VW Bora Variant [1J6]













	1.4	OFD	05.00-05.05	55	RLE	0 204 125 505	
	1.6, FSI	OFD	05.99-05.05	74/75/77/81	RLE	0 204 125 505	
	1.8 T, 4Motion	OFD	05.99-05.05	92/110/132	RLE	0 204 125 505	
	1.9 TDI	OFD	09.98-05.05	66/74/81/	RLE	0 204 125 505	
	1.9 TDI 4Motion			85/96/110			
	2.0, 4Motion	OFD	05.99-05.05	85	RLE	0 204 125 505	
	2.3, 4Motion	OFD	05.99-05.05	110/125	RLE	0 204 125 505	
	2.8 4Motion	OFD	05.99-05.05	150	RLE	0 204 125 505	

	1.4		05.00-05.05	55	LLE	0 986 486 031	15,87
					RLE,TW	0 986 486 047	15,87
	1.6		05.99-05.05	74/75/77/	LLE	0 986 486 031	15,87
	1.6 FSI			81	RLE,TW	0 986 486 047	15,87
	1.8 T		05.99-05.05	92/110/	LLE	0 986 486 031	15,87
	1.8 4Motion			132	RLE,TW	0 986 486 047	15,87
	1.9 TDI		09.98-05.05	66/74/81/	LLE	0 986 486 031	15,87
	1.9 TDI 4Motion			85/96/110	RLE,TW	0 986 486 047	15,87
	2.0		05.99-05.05	85	LLE	0 986 486 031	15,87
	2.0 4Motion				RLE,TW	0 986 486 047	15,87
	2.3		05.99-02.01	110	RLE,TW	0 986 486 047	15,87
	2.3		05.99-02.01	110	LLE	0 986 486 031	15,87
	2.3 4Motion		09.00-05.05	125	LLE	0 986 486 031	15,87
					RLE,TW	0 986 486 047	15,87
	2.3 4Motion		05.00-02.01	110	RLE,TW	0 986 486 047	15,87
						0 986 486 060	15,87
	2.8 4Motion		05.99-05.05	150	LLE	0 986 486 031	15,87
					RLE,TW	0 986 486 047	15,87

	1.4		05.00-05.05	55	FSG	0 986 486 542	23,81	
					PR-Code OEJ	FSZ	0 986 486 576	19
					PR-Code OEM	FSZ	0 986 486 554	19,05
	1.6		05.99-05.05	74/75/77/	FSG	0 986 486 542	23,81	
	1.6 FSI			81	PR-Code OEJ	FSZ	0 986 486 576	19
					PR-Code OEM	FSZ	0 986 486 554	19,05
	1.8 T		05.99-05.05	92/110/	FSG	0 986 486 542	23,81	
	1.8 4Motion			132	PR-Code OEJ	FSZ	0 986 486 576	19
					PR-Code OEM	FSZ	0 986 486 554	19,05
	1.9 TDI		09.98-05.05	66/74/81/	FSG	0 986 486 542	23,81	
	1.9 TDI 4Motion			85/96/110	PR-Code OEJ	FSZ	0 986 486 576	19
					PR-Code OEM	FSZ	0 986 486 554	19,05
	2.0		05.99-05.05	85	FSG	0 986 486 542	23,81	
	2.0 4Motion				PR-Code OEJ	FSZ	0 986 486 576	19
					PR-Code OEM	FSZ	0 986 486 554	19,05
	2.3		05.99-05.05	110/125	FSG	0 986 486 542	23,81	
	2.3 4Motion				PR-Code OEJ	FSZ	0 986 486 576	19
					PR-Code OEM	FSZ	0 986 486 554	19,05
	2.8 4Motion		05.99-05.05	150	FSG	0 986 486 542	23,81	
					PR-Code OEJ	FSZ	0 986 486 576	19
				PR-Code OEM	FSZ	0 986 486 554	19,05	













Bora [1J2]

	1.4	MFD	09.98-05.05	55	JBH,LLE,M20	0 986 481 022	23,81
		OFD	09.98-05.05	55	LLE	F 026 003 339	23,81
					RLE	0 204 123 406	23,81
	1.6	MFD	09.98-05.05	74/75/77/81	JBH,LLE,M20	0 986 481 022	23,81
		OFD	09.98-05.05	74/75/77/81	LLE	F 026 003 339	23,81
					RLE	0 204 123 406	23,81
	1.8	MFD	09.98-05.05	92/110/132	JBH,LLE,M20	0 986 481 022	23,81
		OFD	09.98-05.05	92/110/	LLE	F 026 003 339	23,81
				132	RLE	0 204 123 406	23,81









									
1.9 SDI	MFD	09.98-05.05	50/66/74/81/			JBH,LLE,M20	0 986 481 022	23,81	
1.9 TDI	OFD	09.98-05.05	50/66/74/81/			LLE	F 026 003 339	23,81	
1.9 TDI 4Motion			85/96/110			RLE	0 204 123 406	23,81	
2.0	MFD	09.98-05.05	85			JBH,LLE,M20	0 986 481 022	23,81	
2.0 4Motion	OFD	09.98-05.05	85			LLE	F 026 003 339	23,81	
						RLE	0 204 123 406	23,81	
2.3	MFD	09.98-05.05	110/125			JBH,LLE,M20	0 986 481 022	23,81	
2.3 4Motion	OFD	09.98-05.05	110/125			LLE	F 026 003 339	23,81	
						RLE	0 204 123 406	23,81	
2.8 4Motion	MFD	05.99-05.05	150			JBH,LLE,M20	0 986 481 022	23,81	
	OFD	05.99-05.05	150			LLE	F 026 003 339	23,81	
						RLE	0 204 123 406	23,81	
 1.4	OFD	09.98-05.05	55			RLE	0 204 125 505		
1.6, FSI	OFD	09.98-05.05	74/75/77/81			RLE	0 204 125 505		
1.8, T, 4Motion	OFD	09.98-05.05	92/110/132			RLE	0 204 125 505		
1.9 SDI, TDI, TDI 4Motion	OFD	09.98-05.05	50/66/74/81/85/96/110			RLE	0 204 125 505		
2.0, 4Motion	OFD	09.98-05.05	85			RLE	0 204 125 505		
2.3, 4Motion	OFD	09.98-05.05	110/125			RLE	0 204 125 505		
2.8 4Motion	OFD	05.99-05.05	150			RLE	0 204 125 505		
 1.4		09.98-05.05	55			LLE	0 986 486 031	15,87	
						RLE,TW	0 986 486 047	15,87	
1.6		09.98-05.05	74/75/77/			LLE	0 986 486 031	15,87	
1.6 FSI			81			RLE,TW	0 986 486 047	15,87	
1.8, T, 4Motion		09.98-05.05	92/110/			LLE	0 986 486 031	15,87	
			132			RLE,TW	0 986 486 047	15,87	
1.9 SDI, TDI, TDI 4Motion		09.98-05.05	50/66/74/81/			LLE	0 986 486 031	15,87	
			85/96/110			RLE,TW	0 986 486 047	15,87	
2.0		09.98-05.05	85			LLE	0 986 486 031	15,87	
2.0 4Motion						RLE,TW	0 986 486 047	15,87	
2.3		09.98-05.05	110/125			LLE	0 986 486 031	15,87	
2.3 4Motion						RLE,TW	0 986 486 047	15,87	
							0 986 486 060	15,87	
2.8 4Motion		05.99-05.05	150			LLE	0 986 486 031	15,87	
						RLE,TW	0 986 486 047	15,87	
		05.01-05.05	150			RLE,TW	0 986 486 060	15,87	
 1.4		09.98-05.05	55			FSG	0 986 486 542	23,81	
						PR-Code OEJ	FSZ	0 986 486 576	19
						PR-Code OEM	FSZ	0 986 486 554	19,05
1.6		09.98-05.05	74			FSG	0 986 486 542	23,81	
						PR-Code OEJ	FSZ	0 986 486 576	19
						PR-Code OEM	FSZ	0 986 486 554	19,05
		09.00-05.05	75			FSG	0 986 486 542	23,81	
						PR-Code OEJ	FSZ	0 986 486 576	19
						PR-Code OEM	FSZ	0 986 486 554	19,05
		05.02-05.05	75			FSZ	0 986 486 538	19	
1.6		08.99-05.05	77/81			FSG	0 986 486 542	23,81	
1.6 FSI						PR-Code OEJ	FSZ	0 986 486 576	19
						PR-Code OEM	FSZ	0 986 486 554	19,05
1.8		09.98-05.05	92/110/			FSG	0 986 486 542	23,81	
1.8 T			132			PR-Code OEJ	FSZ	0 986 486 576	19
1.8 4Motion						PR-Code OEM	FSZ	0 986 486 554	19,05
1.9 SDI		09.98-05.05	50/66/74/			FSG	0 986 486 542	23,81	
1.9 TDI			81/85/96/			PR-Code OEJ	FSZ	0 986 486 576	19
1.9 TDI 4Motion			110			PR-Code OEM	FSZ	0 986 486 554	19,05
2.0		09.98-05.05	85			FSG	0 986 486 542	23,81	
						FSZ	0 986 486 538	19	
2.0		09.98-05.05	85			PR-Code OEJ	FSZ	0 986 486 576	19
2.0 4Motion						PR-Code OEM	FSZ	0 986 486 554	19,05
2.0 4Motion		04.00-05.05	85			FSG	0 986 486 542	23,81	

		S							
	◀ VW Bora [1J2]								
	2.3	09.98-05.05	110/125			FSG	0986 486 542	23,81	
	2.3 4Motion			PR-Code OEJ		FSZ	0986 486 576	19	
				PR-Code OEM		FSZ	0986 486 554	19,05	
	2.8 4Motion	05.99-05.05	150			FSG	0986 486 542	23,81	
				PR-Code OEJ		FSZ	0986 486 576	19	
				PR-Code OEM		FSZ	0986 486 554	19,05	
Bora [9M2]									
	2.0	09.02-09.12	85				F 026 003 339	23,81	
Caddy Panel Van [2K]									
	1.9 TDI	06.04→	77			JBH,LLE	0986 480 870	22	
	1.9 TDI	06.04→	77	PR-Code OEJ			0986 486 576	19	
				PR-Code OEM			0986 486 554	19,05	
Caddy Pickup [9U7]									
	1.6	ABO 06.96-12.00	55			JBH	0986 480 682	22,2	
		ABS 06.96-12.00	55			JBH	0986 481 014	23,81	
	1.9 D	ABO 06.96-12.00	47			JBH	0986 480 682	22,2	
		ABS 06.96-12.00	47			JBH	0986 481 014	23,81	
	1.6	06.96-12.00	55				0986 482 007 ^A		
	1.9 D	06.96-12.00	47				0986 482 007 ^A		
Caddy [SA]									
	1.2 TSI	05.15→	62				0986 486 554	19,05	
	1.4 TGI, TSI	05.15→	81/92				0986 486 576	19	
	1.6 TDI	05.15→	55/75				0986 486 576	19	
	2.0 TDI	05.15→	55/75				0986 486 576	19	
Caddy [2C]									
	1.2 TSI	09.10→	63/77			JBH,LLE	0986 480 870	22	
	1.6, BiFuel, TDI	08.10→	55/72-75			JBH,LLE	0986 480 870	22	
	2.0 EcoFuel, TDI, TDI 4Motion	08.10→	80/81/103/125			JBH,LLE	0986 480 870	22	
	1.2 TSI	09.10→	63/77				0986 486 554	19,05	
	1.6	10.10→	75				0986 486 554	19,05	
	1.6 BiFuel	05.11→	72-75				0986 486 554	19,05	
	1.6 TDI	08.10→	55/75				0986 486 576	19	
	2.0 EcoFuel	10.10→	80				0986 486 554	19,05	
	2.0 TDI	08.10→	81				0986 486 576	19	
	2.0 TDI, TDI 4Motion	11.10→	103				0986 486 595	29	
	2.0 TDI 4Motion	08.10→	81				0986 486 595	29	
Caddy [2K]									
	1.4	02.04-08.10	55/59			JBH,LLE	0986 480 870	22	
	1.6	04.04→	75			JBH,LLE	0986 480 870	22	



		S								
1.9 TDI, TDI 4Motion		02.04-08.10	55/77			JBH,LLE	0 986 480 870	22		
2.0 EcoFuel, SDI, TDI		02.04-08.10	51/80/103			JBH,LLE	0 986 480 870	22		
 1.4		02.04-05.06	55	PR-Code OEJ			0 986 486 576	19		
				PR-Code OEM	FKR		0 986 486 554	19,05		
		05.06-08.10	59	PR-Code OEJ			0 986 486 576	19		
				PR-Code OEM			0 986 486 554	19,05		
1.6		04.04-05.05	75				0 986 486 554	19,05		
		04.04-08.10	75	PR-Code OEM	FKR		0 986 486 554	19,05		
		04.04→	75	PR-Code OEJ			0 986 486 576	19		
		06.04→	75	PR-Code OEM			0 986 486 554	19,05		
1.9 TDI		02.04-08.10	77	PR-Code OEJ			0 986 486 576	19		
				PR-Code OEM			0 986 486 554	19,05		
		09.05-08.10	55	PR-Code OEJ			0 986 486 576	19		
			PR-Code OEM			0 986 486 554	19,05			
1.9 TDI 4Motion		11.08-08.10	77				0 986 486 595	29		
2.0 EcoFuel		02.04-08.10	51/80	PR-Code OEJ			0 986 486 576	19		
2.0 SDI				PR-Code OEM			0 986 486 554	19,05		
2.0 TDI		09.07-08.10	103				0 986 486 595	29		
Caddy [9K9]										
										
 1.4	ABO	11.95-12.97	44			JBH	F 026 003 563	22		
		11.95-08.98	44	Fg.-Nr. →9K..X..514000		JBH,RLE	F 026 003 563	22		
		11.95-06.03	44			JBH,LLE	F 026 003 563	22		
		09.98-06.03	44	Fg.-Nr. 9K..X..514 001→		RLE	0 204 123 521	22,22		
		09.00-06.03	44			RLE	0 204 123 521	22,22		
			55			JBH,LLE	F 026 003 563	22		
						RLE	0 204 123 521	22,22		
		ABS	11.95-06.03	44/55			JBH,LLE	0 986 480 987	23,81	
	1.6	ABO	11.95-05.97	55			JBH	F 026 003 563	22	
			06.97-08.98	55	Fg.-Nr. →9K..X..514000		JBH,RLE	F 026 003 563	22	
		06.97-09.00	55			JBH,LLE	F 026 003 563	22		
		09.98-09.00	55	Fg.-Nr. 9K..X..514 001→		RLE	0 204 123 521	22,22		
		ABS	11.95-09.00	55			JBH,LLE	0 986 480 987	23,81	
1.7 SDI	ABO	07.96-08.98	42	Fg.-Nr. →9K..X..514000		JBH,RLE	F 026 003 563	22		
		07.96-09.00	42			JBH,LLE	F 026 003 563	22		
		09.98-09.00	42	Fg.-Nr. 9K..X..514 001→		RLE	0 204 123 521	22,22		
	ABS	07.96-09.00	42			JBH,LLE	0 986 480 987	23,81		
1.8		09.02-09.05	66			JBH	F 026 003 563	22		
1.9 D	ABO	11.95-08.98	47	Fg.-Nr. →9K..X..514000		JBH,RLE	F 026 003 563	22		
		11.95-06.03	47			JBH,LLE	F 026 003 563	22		
		09.98-06.03	47	Fg.-Nr. 9K..X..514 001→		RLE	0 204 123 521	22,22		
1.9 D, SDI, TDI	ABS	11.95-06.03	47-66			JBH,LLE	0 986 480 987	23,81		
1.9 SDI	ABO	11.95-08.98	47-66	Fg.-Nr. →9K..X..514000		JBH,RLE	F 026 003 563	22		
		11.95-09.00	47-66			JBH,LLE	F 026 003 563	22		
		09.98-09.00	47-66	Fg.-Nr. 9K..X..514 001→		RLE	0 204 123 521	22,22		
		09.00-06.03	47			JBH,LLE	F 026 003 563	22		
					RLE	0 204 123 521	22,22			
1.9 TDI	ABO	10.96-03.97	66			JBH	F 026 003 563	22		
		12.96-08.98	66	Fg.-Nr. →9K..X..514000		JBH,RLE	F 026 003 563	22		
		12.96-06.03	66			JBH,LLE	F 026 003 563	22		
		09.98-09.00	66	Fg.-Nr. 9K..X..514 001→		RLE	0 204 123 521	22,22		
		09.00-06.03	66			RLE	0 204 123 521	22,22		
 1.4	ABO	11.95-06.03	44/55			LLE	0 204 125 262			
						RLE	0 204 125 263			
	ABS	11.95-09.00	44			RLE	0 204 055 380			
1.6	ABO	11.95-09.00	55			LLE	0 204 125 262			
						RLE	0 204 125 263			
	ABS	11.95-09.00	55			RLE	0 204 055 380			

		S																																										
◀ VW Caddy [9K9]																																												
1.7 SDI		ABO	07.96-09.00	42			LLE	0 204 125 262																																				
							RLE	0 204 125 263																																				
1.8			09.02-09.05	66			RLE	0 204 055 380																																				
								0 204 125 262																																				
1.9 D, SDI, TDI		ABO	11.95-06.03	47-66			LLE	0 204 125 262																																				
							RLE	0 204 125 263																																				
1.9 SDI, TDI		ABS	11.95-09.00	47-66			RLE	0 204 055 380																																				
	1.8		09.02-09.05	66				0 986 486 109	15,8																																			
							1.9 SDI	09.00-06.03	47			LLE	0 986 486 109	15,8																														
												1.9 TDI	10.96-09.00	66			LLE	0 986 486 038	19																									
																	LLE	0 986 486 109	15,8																									
	1.8		09.02-09.05	66				0 986 486 538	19																																			
							1.9 SDI	09.00-06.03	47				0 986 486 542	23,81																														
												1.9 TDI	10.96-09.00	66			0 986 486 537	23,8																										
	1.4		11.95-06.03	44/55				0 204 031 290 ^A																																				
	1.6		11.95-09.00	55				0 204 031 290 ^A																																				
	1.7 SDI		07.96-09.00	42				0 204 031 290 ^A																																				
	1.8		09.02-09.05	66				0 204 031 290 ^A																																				
	1.9 D, SDI, TDI		11.95-06.03	47-66				0 204 031 290 ^A																																				
	California T4 [70, 7D]																																											
	1.9 D	ABS, OFD	09.90-04.97	45	Fg.-Nr. 70..S..127 806→		254,JBH	0 986 481 007	25,4																																			
								MFD	09.90-04.97	45		JBH	0 986 480 933	23,81																														
												JBH	0 986 481 007	25,4																														
	1.9 D Turbo	ABS, OFD	10.92-06.03	50	Fg.-Nr. 70..S..127 806→		254,JBH	0 986 481 007	25,4																																			
								MFD	06.95-06.03	50		JBH	0 986 480 933	23,81																														
									10.92-06.03	50		JBH	0 986 481 007	25,4																														
	1.9 D	ABO	09.90-06.03	45/50	Fg.-Nr. 70..S..127 806→		254,JBH	0 986 481 030	25,4																																			
								1.9 D Turbo	06.95-06.03	45/50	Fg.-Nr. 70..S..127 806→		JBH	0 986 480 930	23,81																													
														ABO	09.90-05.95	45/50	Fg.-Nr. →70..S..127 805	JBH	F 026 003 563	22																								
	2.0	ABS, OFD	09.90-05.95	45/50	Fg.-Nr. →70..S..127 805		JBH	0 986 480 834	22,2																																			
								2.0	ABO	09.90-06.03	62	Fg.-Nr. 70..S..127 806→		254,JBH	0 986 481 030	25,4																												
															ABO	06.95-06.03	62	Fg.-Nr. 70..S..127 806→		JBH	0 986 480 930	23,81																						
																					ABO	09.90-05.95	62	Fg.-Nr. →70..S..127 805	JBH	F 026 003 563	22																	
								2.4 D	ABS, OFD	09.90-05.95	62	Fg.-Nr. →70..S..127 805		JBH	0 986 480 834	22,2																												
															2.4 D	ABO	09.90-06.03	62	Fg.-Nr. 70..S..127 806→		254,JBH	0 986 481 007	25,4																					
																						ABO	06.95-06.03	62	Fg.-Nr. 70..S..127 806→		JBH	0 986 480 933	23,81															
																												ABO	09.90-05.95	62	Fg.-Nr. →70..S..127 805		JBH	0 986 481 007	25,4									
	ABO	09.90-05.95	62	Fg.-Nr. →70..S..127 805	JBH	0 986 480 834	22,2																																					
	2.4 D Syncro	ABS, OFD	05.97-06.03	55	Fg.-Nr. 70..S..127 806→		254,JBH	0 986 481 007	25,4																																			
								2.4 D	ABO	09.90-06.03	62	Fg.-Nr. 70..S..127 806→		254,JBH	0 986 480 930	23,81																												
															2.4 D	ABS	09.90-05.98	57	Fg.-Nr. →70..S..127 805		JBH	0 986 481 007	25,4																					
																						2.4 D	OFD	05.97-06.03	55			254,JBH	0 986 480 933	23,81														
																													2.4 D	MFD	09.90-05.98	57			254,JBH	0 986 481 007	25,4							
																																				2.4 D	OFD	05.97-06.03	55			254,JBH	0 986 481 007	25,4
																																											2.4 D Syncro	11.92-09.98
	2.4 D	MFD	11.92-09.98	57			JBH	0 986 481 007	25,4																																			
								2.4 D Syncro	ABO	09.90-09.98	57	Fg.-Nr. 70..S..127 806→		254,JBH	0 986 481 030	25,4																												
	2.4 D Syncro	ABS, OFD	06.95-09.98	57	Fg.-Nr. 70..S..127 806→		JBH								0 986 480 930	23,81																												
								2.4 D Syncro	ABO	09.90-05.95	57	Fg.-Nr. →70..S..127 805		JBH	F 026 003 563	22																												
															2.4 D Syncro	ABS	09.90-05.95	57	Fg.-Nr. →70..S..127 805		JBH	0 986 480 834	22,2																					
																						2.4 D Syncro	ABS	06.95-09.98	57	Fg.-Nr. 70..S..127 806→		JBH	0 986 480 933	23,81														
																													2.4 D Syncro	OFD														

		S							
2.5	ABO	06.95-10.96	81	Fg.-Nr. 70..S..127 806→	JBH	0 986 480 930	23,81		
		09.95-12.95	81		JBH	0 986 480 930	23,81		
		08.96-06.03	81		JBH	0 986 480 930	23,81		
	ABS,	07.94-06.03	81		254,JBH	0 986 481 007	25,4		
	OFD	06.95-10.96	81	Fg.-Nr. 70..S..127 806→	JBH	0 986 480 933	23,81		
		09.95-12.95	81		JBH	0 986 480 933	23,81		
		08.96-06.03	81		JBH	0 986 480 933	23,81		
			85		254,JBH	0 986 481 007	25,4		
	MFD	07.94-06.03	81		JBH	0 986 481 007	25,4		
		08.96-06.03	85		JBH	0 986 481 007	25,4		
2.5	ABO	01.94-06.03	81		254,JBH	0 986 481 030	25,4		
2.5 Syncro	ABS	01.94-05.95	81	Fg.-Nr. →70..S..127 805	JBH	0 986 480 834	22,2		
	ABS,	08.96-06.03	85		JBH	0 986 480 933	23,81		
	OFD								
2.5	ABO	08.96-06.03	85/111		JBH	0 986 480 930	23,81		
2.5 Syncro					254,JBH	0 986 481 030	25,4		
2.5 TDI	ABO,	01.94-05.95	75/81	Fg.-Nr. →70..S..127 805	JBH	F 026 003 563	22		
	OFD								
2.5 Syncro	ABO	06.95-10.96	81	Fg.-Nr. 70..S..127 806→	JBH	0 986 480 930	23,81		
		06.97-11.01	81		JBH	0 986 480 930	23,81		
	ABS,	01.94-10.96	81		254,JBH	0 986 481 007	25,4		
	OFD	06.95-10.96	81	Fg.-Nr. 70..S..127 806→	JBH	0 986 480 933	23,81		
		08.96-06.03	85		254,JBH	0 986 481 007	25,4		
		06.97-11.01	81		JBH	0 986 480 933	23,81		
					254,JBH	0 986 481 007	25,4		
	MFD	01.94-10.96	81		JBH	0 986 481 007	25,4		
		08.96-06.03	85		JBH	0 986 481 007	25,4		
		06.97-11.01	81		JBH	0 986 481 007	25,4		
2.5 TDI	ABO	06.95-06.03	75	Fg.-Nr. 70..S..127 806→	JBH	0 986 480 930	23,81		
		05.98-06.03	65		JBH	0 986 480 930	23,81		
					254,JBH	0 986 481 030	25,4		
		05.99-06.03	75		JBH	0 986 480 930	23,81		
	ABS	01.95-05.95	75	Fg.-Nr. →70..S..127 805	JBH	0 986 480 834	22,2		
	ABS,	01.95-06.03	75		254,JBH	0 986 481 007	25,4		
	OFD	06.95-06.03	75	Fg.-Nr. 70..S..127 806→	JBH	0 986 480 933	23,81		
		05.98-06.03	65		JBH	0 986 480 933	23,81		
					254,JBH	0 986 481 007	25,4		
			111		JBH	0 986 480 933	23,81		
					254,JBH	0 986 481 007	25,4		
		05.99-06.03	75		JBH	0 986 480 933	23,81		
	MFD	01.95-06.03	75		JBH	0 986 481 007	25,4		
		05.98-06.03	65		JBH	0 986 481 007	25,4		
			111		JBH	0 986 481 007	25,4		
2.5 TDI Syncro	ABO	03.98-06.03	75		JBH	0 986 480 930	23,81		
	ABS	04.01-06.03	75		JBH	0 986 480 933	23,81		
	ABS,	03.98-06.03	75		JBH	0 986 480 933	23,81		
	OFD				254,JBH	0 986 481 007	25,4		
	MFD	03.98-06.03	75		JBH	0 986 481 007	25,4		
2.5 TDI, TDI Syncro	ABO	01.95-06.03	75		254,JBH	0 986 481 030	25,4		
2.8	ABO	05.96-06.03	103/150		JBH	0 986 480 930	23,81		
					254,JBH	0 986 481 030	25,4		
	ABS,	05.96-05.00	103		JBH	0 986 480 933	23,81		
	OFD				254,JBH	0 986 481 007	25,4		
		05.00-06.03	150		JBH	0 986 480 933	23,81		
					254,JBH	0 986 481 007	25,4		
	MFD	05.96-05.00	103		JBH	0 986 481 007	25,4		
	05.00-06.03	150		JBH	0 986 481 007	25,4			
	1.9 D	09.90-06.03	45/50		TW	0 986 486 037	19,05		
	1.9 D Turbo					0 986 486 048	15,87		
	2.0	09.90-06.03	62		TW	0 986 486 037	19,05		
						0 986 486 048	15,87		













	◀ VW California T4 [70, 7D]								
	2.4 D	09.90-06.03	55/57		TW		0986 486 037	19,05	
	2.4 D Syncro						0986 486 048	15,87	
	2.5, Syncro, TDI	01.94-06.03	81/85/111		TW		0986 486 037	19,05	
							0986 486 048	15,87	
	2.5 TDI	01.95-06.03	75		TW		0986 486 048	15,87	
		05.98-06.03	65		TW		0986 486 037	19,05	
							0986 486 048	15,87	
	2.5 TDI Syncro	03.98-06.03	75		TW		0986 486 048	15,87	
		04.01-06.03	75				0986 486 048	15,87	
	2.5 TDI, TDI Syncro	01.95-06.03	75		TW		0986 486 037	19,05	
	2.8	05.96-06.03	103/150		TW		0986 486 037	19,05	
							0986 486 048	15,87	
	1.9 D	09.90-04.97	45				0986 486 537	23,8	
	1.9 D Turbo	10.92-04.97	50				0986 486 537	23,8	
		05.97-06.03	50				0986 486 576	19	
	2.0	09.90-04.97	62				0986 486 537	23,8	
		05.97-06.03	62				0986 486 576	19	
	2.4 D	05.97-06.03	55				0986 486 576	19	
	2.4 D	09.90-04.97	57				0986 486 537	23,8	
	2.4 D Syncro	05.97-09.98	57				0986 486 576	19	
	2.5	01.94-04.97	81/85				0986 486 537	23,8	
	2.5 Syncro	05.97-06.03	81/85				0986 486 576	19	
	2.5 TDI	05.98-06.03	65				0986 486 576	19	
	2.8	05.00-06.03	150				0986 486 576	19	
	1.9 D, D Turbo	09.90-06.03	45/50				0986 482 036 ^A		
	2.0	09.90-06.03	62				0986 482 036 ^A		
	2.4 D, D Syncro	09.90-06.03	55/57				0986 482 036 ^A		
	2.5, Syncro, TDI, TDI Syncro	01.94-06.03	65/75/81/85/111				0986 482 036 ^A		
	2.8	05.96-06.03	103/150				0986 482 036 ^A		
	1.9 D	09.90-06.03	45/50				0265 202 454 ^M		
	1.9 D Turbo	01.96-06.03	45/50				0265 220 434 ^F		
	2.0	09.90-06.03	62				0265 202 454 ^M		
		01.96-06.03	62				0265 220 434 ^F		
	2.4 D	09.90-06.03	55/57				0265 202 454 ^M		
	2.4 D Syncro	01.96-06.03	55/57				0265 220 434 ^F		
	2.5, Syncro, TDI, TDI Syncro	01.94-06.03	65/75/81/85/111				0265 202 454 ^M		
		01.96-06.03	65/75/81/85/111				0265 220 434 ^F		
	2.8	05.96-05.00	103				0265 202 454 ^M		
		10.97-05.00	103	Fg.-Nr. 70..W..062 420→			0265 220 434 ^F		
		05.00-06.03	150				0265 202 454 ^M		
							0265 220 434 ^F		
	1.9 D	09.90-12.95	45/50				0265 100 072 ^H		
	1.9 D Turbo	09.90-06.03	45/50		1KX,326		0265 109 612 ^M		
					281,284,GRG		0265 109 602 ^M		
	2.0	09.90-12.95	62				0265 100 072 ^H		
		09.90-06.03	62		1KX,326		0265 109 612 ^M		
					281,284,GRG		0265 109 602 ^M		
	2.4 D	05.97-06.03	55		1KX,326		0265 109 612 ^M		
					281,284,GRG		0265 109 602 ^M		
	2.4 D	09.90-12.95	57				0265 100 072 ^H		
	2.4 D Syncro	09.90-09.98	57		1KX,326		0265 109 612 ^M		
					281,284,GRG		0265 109 602 ^M		
	2.5	01.94-12.95	81				0265 100 072 ^H		
	2.5 Syncro	01.94-06.03	81		1KX,326		0265 109 612 ^M		
					281,284,GRG		0265 109 602 ^M		
	2.5, Syncro, TDI	08.96-06.03	85/111		1KX,326		0265 109 612 ^M		
					281,284,GRG		0265 109 602 ^M		

		S									
2.5 TDI		01.95-12.95	75						0 265 100 072 ^H		
		01.95-06.03	75			1KX,326			0 265 109 612 ^M		
						281,284,GRG			0 265 109 602 ^M		
		05.98-06.03	65			1KX,326			0 265 109 612 ^M		
2.5 TDI Syncro		03.98-06.03	75			1KX,326			0 265 109 612 ^M		
						281,284,GRG			0 265 109 602 ^M		
		04.01-05.02	75		Fg.-Nr. →70..3..019 101	GRG			0 265 109 602 ^M		
		06.02-06.03	75		Fg.-Nr. 70..3..019 102→			0 265 109 612 ^M			
2.8		05.96-06.03	103/150			1KX,326			0 265 109 612 ^M		
						281,284,GRG			0 265 109 602 ^M		
		1.9 D, D Turbo	09.90-06.03	45/50					0 265 005 214		
		2.0	09.90-06.03	62					0 265 005 214		
		2.4 D, D Syncro	09.90-06.03	55/57					0 265 005 214		
		2.5, Syncro, TDI, TDI Syncro	01.94-06.03	65/75/81/85/111					0 265 005 214		
		2.8	05.96-06.03	103/150					0 265 005 214		
California T5 [7E]											
		2.0 TDI, TDI 4Motion, TSI, TSI 4Motion	09.09→	100/103/110/132/150					0 986 486 595	29	
California T5 [7H]											
		1.9 TDI	04.03-11.09	62/63/75/77		JBH			0 986 480 992	27	
		2.0	06.03-11.09	85		JBH			0 986 480 992	27	
		2.5 TDI	02.03-11.09	96		JBH,LLE			0 986 480 992	27	
				128		JBH,LLE			0 986 480 992	27	
			11.03-11.09	120		JBH			0 986 480 992	27	
		2.5 TDI 4Motion	01.06-11.09	96		PR-Code 1AT	JBH			0 986 480 992	27
				128		PR-Code 1AT	JBH			0 986 480 992	27
			07.04-11.09	96		JBH,LLE			0 986 480 992	27	
		2.5 TDI 4Motion		128		JBH,LLE			0 986 480 992	27	
			01.06-11.09	96		JBH			0 986 480 992	27	
				128		JBH			0 986 480 992	27	
		3.2	02.03-06.04	170		JBH			0 986 480 992	27	
			05.03-11.09	173		PR-Code 1AT	JBH			0 986 480 992	27
3.2 4Motion	07.04-11.09	173		JBH			0 986 480 992	27			
		2.5 TDI, TDI 4Motion	02.03-11.09	96/120/128					0 986 486 595	29	
		3.2, 4Motion	02.03-11.09	170/173					0 986 486 595	29	
California T6 [SG]											
		2.0 TDI, TDI 4Motion, TFSI	04.15→	103/110/132/150					0 986 486 595	29	
Caravelle T4 [70, 7D]											
		1.9 D	ABS, 10.90-04.97	45		254,JBH			0 986 481 007	25,4	
			OFD 06.95-04.97	45		Fg.-Nr. 70..S..127 806→	JBH			0 986 480 933	23,81
			MFD 10.90-04.97	45		JBH				0 986 481 007	25,4
		1.9 D Turbo	ABS, 10.92-06.03	50		254,JBH				0 986 481 007	25,4
			OFD 06.95-06.03	50		Fg.-Nr. 70..S..127 806→	JBH			0 986 480 933	23,81
			MFD 10.92-06.03	50		JBH				0 986 481 007	25,4



		S							
◀ VW Caravelle T4 [70, 7D]									
1.9 D	ABO	10.90-06.03	45/50			254,JBH	0 986 481 030	25,4	
1.9 D Turbo		06.95-06.03	45/50	Fg.-Nr. 70..S..127 806→		JBH	0 986 480 930	23,81	
	ABO,	10.90-05.95	45/50	Fg.-Nr. →70..S..127 805		JBH	F 026 003 563	22	
	OFD								
2.0	ABS	10.90-05.95	45/50	Fg.-Nr. →70..S..127 805		JBH	0 986 480 834	22,2	
	ABO	09.90-06.03	62	Fg.-Nr. 70..S..127 806→		JBH	0 986 480 930	23,81	
	ABO,	09.90-05.95	62	Fg.-Nr. →70..S..127 805		JBH	F 026 003 563	22	
2.0	OFD								
	ABS	09.90-05.95	62	Fg.-Nr. →70..S..127 805		JBH	0 986 480 834	22,2	
	ABS,	09.90-06.03	62			254,JBH	0 986 481 007	25,4	
2.4 D	OFD	06.95-06.03	62	Fg.-Nr. 70..S..127 806→		JBH	0 986 480 933	23,81	
	MFD	09.90-06.03	62			JBH	0 986 481 007	25,4	
	ABO	05.97-06.03	55			JBH	0 986 480 930	23,81	
2.4 D						254,JBH	0 986 481 030	25,4	
	ABS,	09.90-05.98	57			254,JBH	0 986 481 007	25,4	
	OFD	05.97-06.03	55			JBH	0 986 480 933	23,81	
2.4 D Syncro						254,JBH	0 986 481 007	25,4	
	ABS,	11.92-09.98	57			254,JBH	0 986 481 007	25,4	
	OFD								
2.4 D	MFD	11.92-09.98	57			JBH	0 986 481 007	25,4	
	ABO	09.90-09.98	57			254,JBH	0 986 481 030	25,4	
	2.4 D Syncro								
2.4 D Syncro		06.95-09.98	57	Fg.-Nr. 70..S..127 806→		JBH	0 986 480 930	23,81	
	ABO,	09.90-05.95	57	Fg.-Nr. →70..S..127 805		JBH	F 026 003 563	22	
	OFD								
2.5	ABS	09.90-05.95	57	Fg.-Nr. →70..S..127 805		JBH	0 986 480 834	22,2	
	ABS,	06.95-09.98	57	Fg.-Nr. 70..S..127 806→		JBH	0 986 480 933	23,81	
	OFD								
2.5	ABO	06.95-10.96	81	Fg.-Nr. 70..S..127 806→		JBH	0 986 480 930	23,81	
		09.95-12.95	81			JBH	0 986 480 930	23,81	
		08.96-06.03	81			JBH	0 986 480 930	23,81	
2.5	ABS,	07.94-06.03	81			254,JBH	0 986 481 007	25,4	
	OFD	06.95-10.96	81	Fg.-Nr. 70..S..127 806→		JBH	0 986 480 933	23,81	
		09.95-12.95	81			JBH	0 986 480 933	23,81	
2.5		08.96-06.03	81			JBH	0 986 480 933	23,81	
			85			254,JBH	0 986 481 007	25,4	
	MFD	07.94-06.03	81			JBH	0 986 481 007	25,4	
2.5		08.96-06.03	85			JBH	0 986 481 007	25,4	
	ABO	01.94-06.03	81			254,JBH	0 986 481 030	25,4	
	2.5 Syncro								
2.5 Syncro	ABS	01.94-05.95	81	Fg.-Nr. →70..S..127 805		JBH	0 986 480 834	22,2	
	ABS,	08.96-06.03	85			JBH	0 986 480 933	23,81	
	OFD								
2.5	ABO	08.96-06.03	85/111			JBH	0 986 480 930	23,81	
						254,JBH	0 986 481 030	25,4	
	2.5 TDI								
2.5 TDI	ABO,	01.94-05.95	75/81	Fg.-Nr. →70..S..127 805		JBH	F 026 003 563	22	
	OFD								
	2.5 Syncro								
2.5 Syncro	ABO	06.95-10.96	81	Fg.-Nr. 70..S..127 806→		JBH	0 986 480 930	23,81	
		06.97-11.01	81			JBH	0 986 480 930	23,81	
	ABS,	01.94-10.96	81			254,JBH	0 986 481 007	25,4	
2.5 Syncro	OFD	06.95-10.96	81	Fg.-Nr. 70..S..127 806→		JBH	0 986 480 933	23,81	
		08.96-06.03	85			254,JBH	0 986 481 007	25,4	
		06.97-11.01	81			JBH	0 986 480 933	23,81	
2.5 Syncro						254,JBH	0 986 481 007	25,4	
	MFD	01.94-10.96	81			JBH	0 986 481 007	25,4	
		08.96-06.03	85			JBH	0 986 481 007	25,4	
2.5 TDI		06.97-11.01	81			JBH	0 986 481 007	25,4	
	ABO	06.95-06.03	75	Fg.-Nr. 70..S..127 806→		JBH	0 986 480 930	23,81	
		05.98-06.03	65			JBH	0 986 480 930	23,81	
2.5 TDI						254,JBH	0 986 481 030	25,4	
		05.99-06.03	75			JBH	0 986 480 930	23,81	

		S								
2.5 TDI	ABS	01.95-05.95	75	Fg.-Nr. →70..S..127 805	JBH	0 986 480 834	22,2			
	ABS,	01.95-06.03	75		254,JBH	0 986 481 007	25,4			
	OFD	06.95-06.03	75	Fg.-Nr. 70..S..127 806→	JBH	0 986 480 933	23,81			
		05.98-06.03	65		JBH	0 986 480 933	23,81			
					254,JBH	0 986 481 007	25,4			
			111		JBH	0 986 480 933	23,81			
					254,JBH	0 986 481 007	25,4			
		05.99-06.03	75		JBH	0 986 480 933	23,81			
	MFD	01.95-06.03	75		JBH	0 986 481 007	25,4			
		05.98-06.03	65		JBH	0 986 481 007	25,4			
		111		JBH	0 986 481 007	25,4				
2.5 TDI Syncro	ABO	03.98-06.03	75		JBH	0 986 480 930	23,81			
	ABS	04.01-06.03	75		JBH	0 986 480 933	23,81			
	ABS,	03.98-06.03	75		JBH	0 986 480 933	23,81			
	OFD				254,JBH	0 986 481 007	25,4			
	MFD	03.98-06.03	75		JBH	0 986 481 007	25,4			
2.5 TDI, TDI Syncro	ABO	01.95-06.03	75		254,JBH	0 986 481 030	25,4			
2.8	ABO	01.96-06.03	103/150		JBH	0 986 480 930	23,81			
					254,JBH	0 986 481 030	25,4			
	ABS,	01.96-05.00	103		JBH	0 986 480 933	23,81			
	OFD				254,JBH	0 986 481 007	25,4			
		05.00-06.03	150		JBH	0 986 480 933	23,81			
					254,JBH	0 986 481 007	25,4			
	MFD	01.96-05.00	103		JBH	0 986 481 007	25,4			
		05.00-06.03	150		JBH	0 986 481 007	25,4			
	1.9 D	10.90-06.03	45/50		TW	0 986 486 037	19,05			
	1.9 D Turbo					0 986 486 048	15,87			
	2.0	09.90-06.03	62		TW	0 986 486 037	19,05			
						0 986 486 048	15,87			
	2.4 D	09.90-06.03	55/57		TW	0 986 486 037	19,05			
	2.4 D Syncro					0 986 486 048	15,87			
	2.5, Syncro, TDI	01.94-06.03	81/85/111		TW	0 986 486 037	19,05			
						0 986 486 048	15,87			
	2.5 TDI	01.95-06.03	75		TW	0 986 486 048	15,87			
		05.98-06.03	65		TW	0 986 486 037	19,05			
						0 986 486 048	15,87			
	2.5 TDI Syncro	03.98-06.03	75		TW	0 986 486 048	15,87			
		04.01-06.03	75			0 986 486 048	15,87			
	2.5 TDI, TDI Syncro	01.95-06.03	75		TW	0 986 486 037	19,05			
	2.8	01.96-06.03	103/150		TW	0 986 486 037	19,05			
					0 986 486 048	15,87				
	1.9 D	10.90-04.97	45			0 986 486 537	23,8			
	1.9 D Turbo	10.92-04.97	50			0 986 486 537	23,8			
		05.97-06.03	50			0 986 486 576	19			
	2.0	09.90-04.97	62			0 986 486 537	23,8			
		05.97-06.03	62			0 986 486 576	19			
	2.4 D	05.97-06.03	55			0 986 486 576	19			
	2.4 D	09.90-04.97	57			0 986 486 537	23,8			
	2.4 D Syncro	05.97-09.98	57			0 986 486 576	19			
	2.5	01.94-04.97	81/85			0 986 486 537	23,8			
	2.5 Syncro	05.97-06.03	81/85			0 986 486 576	19			
	2.5 TDI	05.98-06.03	65			0 986 486 576	19			
	2.8	05.00-06.03	150			0 986 486 576	19			
		1.9 D	10.90-06.03	45/50			0 986 482 036 ^A			
		1.9 D Turbo								
		2.0	09.90-06.03	62			0 986 482 036 ^A			
2.4 D, D Syncro		09.90-06.03	55/57			0 986 482 036 ^A				
2.5, Syncro, TDI, TDI Syncro		01.94-06.03	65/75/81/85/111			0 986 482 036 ^A				
2.8		01.96-06.03	103/150			0 986 482 036 ^A				

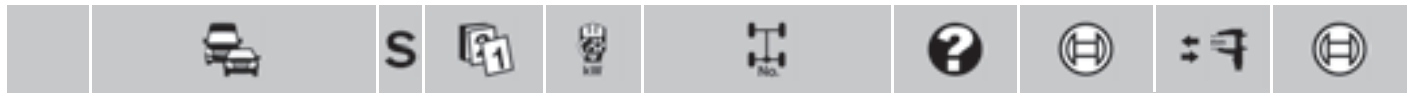

◀ VW Caravelle T4 [70, 7D]

	1.9 D	10.90-06.03	45/50		0 265 202 454 ^M	
	1.9 D Turbo	01.96-06.03	45/50		0 265 220 434 ^F	
	2.0	09.90-06.03	62		0 265 202 454 ^M	
		01.96-06.03	62		0 265 220 434 ^F	
	2.4 D	09.90-06.03	55/57		0 265 202 454 ^M	
		01.96-06.03	55/57		0 265 220 434 ^F	
	2.5, Syncro, TDI, TDI Syncro	01.94-06.03	65/75/81/85/111		0 265 202 454 ^M	
		01.96-06.03	65/75/81/85/111		0 265 220 434 ^F	
	2.8	01.96-05.00	103		0 265 202 454 ^M	
		10.97-05.00	103	Fg.-Nr. 70..W..062 420→	0 265 220 434 ^F	
05.00-06.03		150		0 265 202 454 ^M		

	1.9 D	10.90-12.95	45/50		0 265 100 072 ^H		
	1.9 D Turbo	10.90-06.03	45/50	1KX,326	0 265 109 612 ^M		
				281,284,GRG	0 265 109 602 ^M		
	2.0	09.90-12.95	62		0 265 100 072 ^H		
				09.90-06.03	62	1KX,326	0 265 109 612 ^M
				281,284,GRG	0 265 109 602 ^M		
						1KX,326	0 265 109 612 ^M
	2.4 D	05.97-06.03	55	281,284,GRG	0 265 109 602 ^M		
						1KX,326	0 265 109 612 ^M
	2.4 D	09.90-12.95	57	281,284,GRG	0 265 109 602 ^M		
						1KX,326	0 265 109 612 ^M
	2.4 D Syncro	09.90-09.98	57	281,284,GRG	0 265 109 602 ^M		
						1KX,326	0 265 109 612 ^M
	2.5	01.94-12.95	81		0 265 100 072 ^H		
				01.94-06.03	81	1KX,326	0 265 109 612 ^M
	2.5 Syncro			281,284,GRG	0 265 109 602 ^M		
						1KX,326	0 265 109 612 ^M
	2.5, Syncro, TDI	08.96-06.03	85/111	281,284,GRG	0 265 109 602 ^M		
						1KX,326	0 265 109 612 ^M
	2.5 TDI	01.95-12.95	75		0 265 100 072 ^H		
01.95-06.03				75	1KX,326	0 265 109 612 ^M	
					281,284,GRG	0 265 109 602 ^M	
2.5 TDI Syncro	03.98-06.03	75	1KX,326	0 265 109 612 ^M			
			281,284,GRG	0 265 109 602 ^M			
			04.01-05.02	75	Fg.-Nr. →70..3..019 101	GRG	0 265 109 602 ^M
	06.02-06.03	75	Fg.-Nr. 70..3..019 102→	0 265 109 612 ^M			
2.8	01.96-06.03	103/150	1KX,326	0 265 109 612 ^M			
			281,284,GRG	0 265 109 602 ^M			

	1.9 D, D Turbo	10.90-06.03	45/50		0 265 005 214	
	2.0	09.90-06.03	62		0 265 005 214	
	2.4 D, D Syncro	09.90-06.03	55/57		0 265 005 214	
	2.5, Syncro, TDI, TDI Syncro	01.94-06.03	65/75/81/85/111		0 265 005 214	
	2.8	01.96-06.03	103/150		0 265 005 214	

Caravelle T5 [7E]































	2.0 TDI, TDI 4Motion, TSI, TSI 4Motion	09.09→	100/103/110/ 132/150		0 986 486 595	29
--	--	--------	-------------------------	--	---------------	----

Caravelle T5 [7H]























	1.9 TDI	04.03-11.09	62/63/75/77	JBH	0 986 480 992	27
	2.0	06.03-11.09	85	JBH	0 986 480 992	27
				JBH,LLE	0 986 480 992	27
	2.5 TDI	02.03-11.09	96	JBH,LLE	0 986 480 992	27
11.03-11.09			120	JBH	0 986 480 992	27

		S							
2.5 TDI		01.06-11.09	96	PR-Code 1AT	JBH		0 986 480 992	27	
			128	PR-Code 1AT	JBH		0 986 480 992	27	
2.5 TDI 4Motion		07.04-11.09	96		JBH, LLE		0 986 480 992	27	
			128		JBH, LLE		0 986 480 992	27	
		01.06-11.09	96		JBH		0 986 480 992	27	
			128		JBH		0 986 480 992	27	
3.2		02.03-06.04	170		JBH		0 986 480 992	27	
		05.03-11.09	173	PR-Code 1AT	JBH		0 986 480 992	27	
3.2 4Motion		07.04-11.09	173		JBH		0 986 480 992	27	
 2.5 TDI, TDI 4Motion		02.03-11.09	96/120/128				0 986 486 595	29	
 3.2, 4Motion		02.03-11.09	170/173				0 986 486 595	29	
Caravelle T6 [SG]									
									
 2.0 TDI, TDI 4Motion, TFSI		04.15→	103/110/ 132/150				0 986 486 595	29	
CC [358]									
									
 1.8 TSI		11.11→	112/118				0 986 486 576	19	
 2.0 TSI		11.11→	155				0 986 486 595	29	
Corrado [50]									
									
 2.0 16V		ABO 08.91-07.95	100		JBH		F 026 003 563	22	
 2.0 16V		ABO 08.91-07.95	100		RLE		0 986 485 110		
 2.9		ABO 08.91-07.95	140		RLE		0 986 485 110		
 2.0, 16V		08.91-07.95	85/100				0 986 486 537	23,8	
 2.8		08.91-07.95	128				0 986 486 537	23,8	
 2.9		08.91-07.95	140				0 986 486 537	23,8	
 2.0, 16V		08.91-07.95	85/100				0 986 482 006 ^A		
 2.9		08.91-07.95	140				0 204 131 697 ^A		
Crafter 30 [2E, 2F]									
									
 2.5 TDI		04.06-02.14	65/80/100/ 120		BUS LKW	BO BO	0 204 255 049 F 026 003 486	25,4 26	
 2.5 TDI		04.06-05.11	80/100			BO	0 204 054 468		
		04.06-07.11	65			BO	0 204 054 468		
			120			BO	0 204 054 468		
 2.5 TDI		04.06-03.08	65/80/100/ 120	PR-Code 1X2			0 265 234 098 ^T		
		04.08-02.09	65/80/100/ 120	PR-Code 1X2			0 265 230 402 ^T		
		03.09-05.11	65/80/100/ 120	PR-Code 1X2			0 265 230 235 ^T		
		06.11→	65/80/100/ 120				0 265 251 366 ^T		

◀ VW Crafter 30 [2E, 2F]										
	2.0 BiTDI, TDI	05.11→	80/100/105/120				0 265 005 774			
	2.5 TDI	04.06-02.13	65/80/100/120				0 265 005 774			
Crafter 35 [2E, 2F]										
	2.5 TDI	04.06-02.14	65/80/100/120		BUS	BO	0 204 255 049	25,4		
					LKW	BO	F 026 003 486	26		
	2.5 TDI	04.06-05.11	80/100			BO	0 204 054 468			
		04.06-07.11	65/120			BO	0 204 054 468			
	2.5 TDI	04.06-03.08	65/80/100/120				0 265 234 098 ^T			
		04.08-02.09	65/80/100/120				0 265 230 402 ^T			
		03.09-05.11	65/80/100/120				0 265 230 235 ^T			
		06.11→	80/100				0 265 251 366 ^T			
	2.0 BiTDI, TDI	05.11→	80/100/105/120				0 265 005 774			
	2.5 TDI	04.06-02.13	65/80/100/120				0 265 005 774			
Crafter 50 [2E, 2F]										
	2.5 TDI	04.06-02.14	80/100/120			BO	F 026 003 486	26		
	2.5 TDI	04.06-05.11	80/100			BO	0 204 054 468			
		04.06-07.11	120			BO	0 204 054 468			
	2.5 TDI	04.06-03.08	80/100/120	PR-Code 1X2			0 265 234 100 ^T			
		04.06-05.11	80/100/120	PR-Code 1X9			0 265 235 028 ^T			
		04.06-07.11	120	PR-Code 1X9			0 265 235 028 ^T			
		04.08-02.09	80/100/120	PR-Code 1X2			0 265 230 404 ^T			
		03.09-05.11	80/100/120	PR-Code 1X2			0 265 230 237 ^T			
	2.0 BiTDI, TDI	05.11→	80/100/105/120				0 265 005 774			
	2.5 TDI	04.06-02.13	80/100/120				0 265 005 774			
e-Golf [BE1]										
		03.14→	85		LLE		0 204 819 790			
					RLE		0 204 819 792			
Eos [1F7]										
	2.0 FSI	05.06-05.08	110	PR-Code 1ZD	JBH,LLE		0 986 480 870	22		
		09.06-11.09	147	PR-Code 1ZD	JBH		0 986 480 870	22		
	2.0 TSI	05.06-11.10	147	PR-Code 1ZD	JBH,LLE		0 986 480 870	22		
		11.09-11.10	155	PR-Code 1ZD	JBH,LLE		0 986 480 870	22		
	3.2	05.06-11.10	184	PR-Code 1ZD	JBH,LLE		0 986 480 870	22		
	3.2 FSI	05.07-05.08	184		JBH		0 986 480 870	22		
	1.4 TSI	11.07-11.10	90/118	PR-Code 0EJ			0 986 486 576	19		
				PR-Code 0EM			0 986 486 554	19,05		



		S							
1.6 FSI		05.06-05.08	85	PR-Code OEJ			0 986 486 576	19	
				PR-Code OEM			0 986 486 554	19,05	
2.0 FSI		05.06-05.08	110	PR-Code OEJ			0 986 486 576	19	
				PR-Code OEM			0 986 486 554	19,05	
2.0 FSI, TSI		05.06→	147/155				0 986 486 595	29	
2.0 TDI		05.06-11.10	103				0 986 486 595	29	
3.2		05.06-11.10	184	PR-Code OEJ			0 986 486 576	19	
3.2 FSI				PR-Code OEM			0 986 486 554	19,05	
3.6		05.09-11.10	191	PR-Code OEJ			0 986 486 576	19	
				PR-Code OEM			0 986 486 554	19,05	
Eos [1F8]									
									
	1.4 TSI		11.10→	90/118	PR-Code 1ZD	JBH, LLE	0 986 480 870	22	
	2.0 TDI		11.10→	100/103/	PR-Code 1ZD	JBH, LLE	0 986 480 870	22	
	2.0 TSI			147/155					
	1.4 TSI		11.10→	90			0 986 486 554	19,05	
				118			0 986 486 576	19	
	2.0 TDI, TSI		11.10→	100/103/155			0 986 486 595	29	
Eurovan [70]									
									
	2.4 D	ABO	05.95-08.98	57	Fg.-Nr. 70-S-127 806→	JBH, GIR	0 986 480 930	23,81	
		ABS	01.96-08.98	57		JBH	0 986 481 007	25,4	
	2.8	ABO	05.00-06.03	150	Fg.-Nr. 70-T 200 001→	JBH	0 986 480 930	23,81	
						254, JBH, LLE	0 986 481 030	25,4	
		ABS,	05.00-06.03	150	Fg.-Nr. 70-T 200 001→	JBH	0 986 480 933	23,81	
		EDS							
		MFD	05.00-06.03	150	Fg.-Nr. 70-Y-027 264→	254, JBH	0 986 481 007	25,4	
	2.8		05.00-06.03	150			0 986 486 037	19,05	
	2.8		05.00-06.03	150			0 986 486 576	19	
	2.4 D		10.92-08.98	57			0 986 482 036		
	2.8		05.00-06.03	150			0 986 482 036 ^A		
	2.8		05.00-06.03	150			0 265 202 454 ^M		
	2.4 D		10.92-08.98	57			0 265 100 072 ^H		
	2.8		05.00-06.03	150		15Z, GRG	0 265 109 602 ^M		
						16Z	0 265 109 612 ^M		
	2.8	MFD	05.00-06.03	150			0 265 005 214		
Fox									
									
	1.3		07.87-12.95	48		JBH, RLE	0 986 480 430	20,64	
						RLE			1 987 472 282
	1.6	ABO	10.03→	69		JBH	0 986 480 820	20,6	

			S							
◀ VW										
Fox [Fase I]										
	1.0	ABO	10.03-04.05	53		JBH		0 986 480 820	20,6	
	1.0		10.03-04.05	53				0 265 222 038 ^B		
Fox [5Z1]										
	1.2	ABO	04.05-12.12	40		JBH,TW		0 986 480 820	20,6	
			09.10-12.12	44		JBH,TW		0 986 480 820	20,6	
		ABS	04.05-12.12	40		JBH,TW		0 986 480 820	20,6	
			09.10-12.12	44		JBH,TW		0 986 480 820	20,6	
	1.4	ABO	04.05-12.12	55		JBH,TW		0 986 480 820	20,6	
		ABS	04.05-12.12	55		JBH,TW		0 986 480 820	20,6	
	1.4 TDI	ABO	04.05-12.12	51		JBH,TW		0 986 480 820	20,6	
		ABS	04.05-12.12	51		JBH,TW		0 986 480 820	20,6	
	1.2	ABO	12.06-12.12	40	Fg.-Nr. 5Z..70 040 001→, 5Z..74 068 001→	LLE,TW		0 204 703 385		
					Fg.-Nr. 5Z..70040 001→, 5Z..74068 001→	252,RLE		0 204 0C2 081		
			06.09-12.12	40/44		LLE,TW		0 204 703 385		
						252,RLE		0 204 0C2 081		
		ABS	04.05-11.06	40	Fg.-Nr. →5Z..70040 000, →5Z..74068 000	RLE		0 204 0C2 083		
			12.06-12.12	40	Fg.-Nr. 5Z..70040 001→, 5Z..74068 001→	RLE		0 204 0C2 082		
			06.08-12.12	40		252,LLE,TW		0 204 703 385		
			06.09-12.12	40		RLE		0 204 0C2 082		
						252,RLE,TW		0 204 0C2 083		
			09.10-12.12	44		RLE		0 204 0C2 082		
						252,LLE,TW		0 204 703 385		
						252,RLE,TW		0 204 0C2 083		
	1.4	ABO	12.06-12.12	51/55	Fg.-Nr. 5Z..70 040 001→, 5Z..74 068 001→	LLE,TW		0 204 703 385		
		ABS	06.08-12.12	51/55		252,LLE,TW		0 204 703 385		
	1.4	ABO	12.06-12.12	51/55	Fg.-Nr. 5Z..70040 001→, 5Z..74068 001→	252,RLE		0 204 0C2 081		
	1.4 TDI	ABS	04.05-11.06	51/55	Fg.-Nr. →5Z..70040 000, →5Z..74068 000	RLE		0 204 0C2 083		
			12.06-12.12	51/55	Fg.-Nr. 5Z..70040 001→, 5Z..74068 001→	RLE		0 204 0C2 082		
						252,RLE,TW		0 204 0C2 083		
	1.4 TDI	ABO	12.06-12.12	51/55	Fg.-Nr. 5Z..70 040 001→, 5Z..74 068 001→	LLE,TW		0 204 703 385		
		ABS	06.08-12.12	51/55		252,LLE,TW		0 204 703 385		
	1.2		04.05-12.12	40/44				0 204 031 682 ^A		
	1.4, TDI		04.05-12.12	51/55				0 204 031 682 ^A		
	1.2		04.05-12.12	40/44				0 265 232 294 ^B		
								0 265 234 722 ^T		
	1.4		04.05-12.12	51/55				0 265 232 294 ^B		
	1.4 TDI							0 265 234 722 ^T		
	1.2		04.05-12.12	40/44				0 265 005 692		
	1.4, TDI		04.05-12.12	51/55				0 265 005 692		

















		S							
Gol III [5X]									
	1.0 Mi	08.00-02.05	40/48			JBH	BRB, BSY	0 204 032 931	
						WBH	BRB, BSY	0 204 032 600	
	1.6 Mi	08.00-08.05	65			JBH	BRB, BSY	0 204 032 931	
						WBH	BRB, BSY	0 204 032 600	
	1.0 Mi	08.00-07.01	40				BRB, BSY	0 204 032 613	
		08.01-08.01	48				BRB, BSY	0 204 032 613	
		09.01-02.05	48				BRB, BSY	0 204 032 833	
	1.6 Mi	08.00-08.01	65				BRB, BSY	0 204 032 613	
		09.01-08.05	65				BRB, BSY	0 204 032 833	
	1.6 Mi	09.99-08.05	65					0 265 216 416 ^B	
Gol IV									
	1.8	08.05-06.08	76			JBH		0 204 032 931	
						WBH		0 204 032 600	
	1.8	08.05-06.08	76				BRB, BSY	0 204 032 833	
Golf									
	2.0	MFD 03.95-10.99	85			JBH		0 986 481 022	23,81
		OFD 03.95-10.99	85					F 026 003 339	23,81
	2.0	03.95-10.99	85					0 986 486 031	15,87
	2.0	03.95-10.99	85					0 986 486 542	23,81
Golf Cabriolet [1E, 1V]									
	2.0	ABS 08.95-06.02	85			JBH		0 986 480 987	23,81
	2.0	08.95-06.02	85					0 986 482 007 ^A	



			S							
◀ VW										
Golf I Bakkie [15, 16]										
	1.6	06.81-12.96	60/63				JBH,RLE	0986 480 430	20,64	
							RLE			1987 472 282
	1.8	12.88-12.95	70				JBH,RLE	0986 480 430	20,64	
							RLE			1987 472 282
Golf I [15, 16]										
	1.3	11.79-12.95	44				JBH,RLE	0986 480 430	20,64	
							RLE			1987 472 282
		06.96-06.99	48				JBH	F 026 003 180	20,6	
								F 026 003 563	22	
	1.6	07.85-12.94	60				JBH,RLE	0986 480 430	20,64	
							RLE			1987 472 282
	1.6 i	09.98→	74				JBH	F 026 003 180	20,6	
								F 026 003 563	22	
	1.8	01.83-12.97	70/82				JBH,RLE	0986 480 430	20,64	
	1.8 i						RLE			1987 472 282
Golf I [17]										
	1.4	05.98-12.09	54				JBH	F 026 003 180	20,6	
								F 026 003 563	22	
Golf III										
	2.0 Mi	ABO 01.94-07.98	85				JBH	F 026 003 563	22	
		ABS 01.94-04.95	85				JBH	0986 480 878	23,8	
		05.95-07.98	85				JBH	0986 481 016	22,2	
	2.8 i VR6	07.94-08.94	120				JBH,LLE	0986 480 878	23,8	
										Fg.-Nr. →1H..SB088 704, →1H..SP352 189, →1H..SW385 334
		07.94-12.97	120				JBH,RLE	F 026 003 562	20,6	
								F 026 003 563	22	
		09.94-12.97	120				JBH,LLE	0986 480 987	23,81	
								0986 481 016	22,2	
	2.8 i VR6	07.94-12.97	120				RLE	0986 485 111		
	2.8 i VR6	07.94-12.97	120				LLE	0986 486 038	19	
							RLE	0986 486 045	19,05	
	2.8 i VR6	07.94-12.97	120					0986 486 537	23,8	
	2.8 i VR6	07.94-12.97	120				SBR	0 204 131 697 ^A		
Golf III Cabriolet [1E7]										
	1.6	ABO 10.94-04.98	74				JBH	F 026 003 563	22	
		ABS 10.94-01.95	74				JBH,LLE	0986 480 878	23,8	
		02.95-12.95	74				JBH,LLE	0986 480 987	23,81	
		12.95-04.98	74				JBH,LLE	0986 480 987	23,81	



		S									
1.8	ABO	09.93-04.98	55/66			JBH	F 026 003 563	22			
	ABS	09.93-01.95	55/66	Fg.-Nr. →1E..S..021 846	JBH,LLE	0 986 480 878	23,8				
		02.95-04.98	55/66	Fg.-Nr. 1E..S..021 847→	JBH,LLE	0 986 480 987	23,81				
		01.98-03.98	55/66		JBH,LLE	0 986 480 987	23,81				
1.9 TDI	ABO	08.95-04.98	66/81			JBH	F 026 003 563	22			
	ABS	08.95-04.98	66/81			JBH,LLE	0 986 480 987	23,81			
2.0	ABO	09.93-04.98	85			JBH	F 026 003 563	22			
	ABS	09.93-12.94	85		JBH,LLE	0 986 480 878	23,8				
		10.94-01.95	85	Fg.-Nr. →1E..S..021 846	JBH,LLE	0 986 480 878	23,8				
		02.95-07.95	85	Fg.-Nr. 1E..S..021 847→	JBH,LLE	0 986 480 987	23,81				
		07.95-04.98	85		JBH,LLE	0 986 480 987	23,81				
 2.0	ABO	09.93-12.94	85			RLE	0 986 485 111				
 1.6		10.94-04.98	74			LLE	0 986 486 038	19			
						RLE	0 986 486 045	19,05			
1.8		09.93-04.98	55/66			LLE	0 986 486 038	19			
						RLE	0 986 486 045	19,05			
1.9 TDI		08.95-04.98	66/81			LLE	0 986 486 038	19			
						RLE	0 986 486 045	19,05			
2.0		09.93-04.98	85			LLE	0 986 486 038	19			
						RLE	0 986 486 045	19,05			
 1.6		10.94-04.98	74				0 986 486 537	23,8			
	1.8	09.93-04.98	55/66				0 986 486 537	23,8			
		1.9 TDI	08.95-04.98	66/81				0 986 486 537	23,8		
		2.0	09.93-04.98	85				0 986 486 537	23,8		
 1.6		10.94-04.98	74			TBR	0 986 482 007 ^A				
	1.8	09.93-04.98	55/66			TBR	0 986 482 007 ^A				
		1.9 TDI	08.95-04.98	66			TBR	0 986 482 007 ^A			
			09.96-04.98	81			SBR	0 204 131 697 ^A			
							TBR	0 986 482 007 ^A			
2.0	09.93-04.98	85			TBR	0 986 482 007 ^A					
	07.95-04.98	85			SBR	0 204 131 697 ^A					
Golf III Variant [1H5]											
											
 1.4	ABO	07.93-07.95	40-44			JBH	F 026 003 562	20,6			
		07.95-02.99	44			JBH	F 026 003 562	20,6			
		12.97-05.98	44			JBH	F 026 003 563	22			
	ABS	02.95-02.99	40-44	Fg.-Nr. 1H..SB088 705→, 1H..SP352 190→, 1H..SW385 335→	JBH,LLE	0 986 480 987	23,81				
					JBH,RLE	0 986 480 869	22				
		1.6	ABO	10.94-02.99	74			JBH	F 026 003 563	22	
			ABS	10.94-01.95	74	Fg.-Nr. →1H..SP352189, →1H..SB088704, →1H..SW385334	JBH,LLE	0 986 480 878	23,8		
		02.95-02.99		74	Fg.-Nr. 1H..SB088 705→, 1H..SP352 190→, 1H..SW385 335→	JBH,LLE	0 986 480 987	23,81			
							JBH,RLE	0 986 480 869	22		
	1.8	ABO	07.93-02.99	55			JBH	F 026 003 563	22		
66						JBH	F 026 003 562	20,6			
							F 026 003 563	22			
ABS		07.93-01.95	55/66	Fg.-Nr. →1H..SP352189, →1H..SB088704, →1H..SW385334	JBH,LLE	0 986 480 878	23,8				
		02.95-02.99	55/66	Fg.-Nr. 1H..SB088 705→, 1H..SP352 190→, 1H..SW385 335→	JBH,LLE	0 986 480 987	23,81				
						JBH,RLE	0 986 480 869	22			



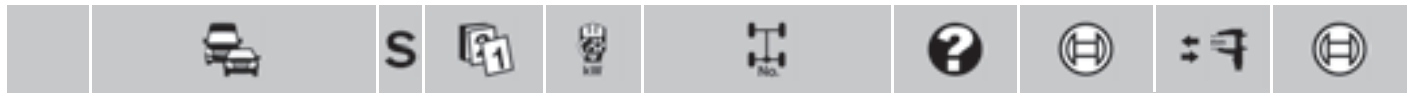













◀ VW Golf III Variant [1H5]













1.8 syncro	ABO	10.94-12.97	66		JBH	F 026 003 563	22
	ABS	02.95-12.97	66	Fg.-Nr. 1H..SW385 335→	JBH	0986 480 987	23,81
1.9 D	ABS	07.93-01.95	47	Fg.-Nr. →1H..SP352189, →1H..SB088704, →1H..SW385334	JBH,LLE	0986 480 878	23,8
		02.95-02.99	47	Fg.-Nr. 1H..SB088 705→, 1H..SP352 190→, 1H..SW385 335→	JBH,LLE	0986 480 987	23,81
1.9 D	ABS	02.95-02.99	47	Fg.-Nr. 1H..SB088 705→, 1H..SP352 190→, 1H..SW385 335→	JBH,LLE	0986 481 016	22,2
1.9 SDI					JBH,RLE	0986 480 869	22
1.9 D, SDI, TD, TDI, TDI syncro	ABO	07.93-02.99	47/55/66/81		JBH	F 026 003 563	22
1.9 SDI	ABS	02.95-02.99	47	Fg.-Nr. 1H..SB088 705→, 1H..SP352 190→, 1H..SW385 335→	JBH,LLE	0986 480 987	23,81
1.9 TD	ABS	02.95-02.99	55	Fg.-Nr. 1H..SB088 705→, 1H..SP352 190→, 1H..SW385 335→	JBH,LLE	0986 480 987	23,81
					JBH,RLE	0986 481 016	22,2
					JBH,RLE	0986 480 869	22
1.9 TDI	ABS	07.93-01.95	66	Fg.-Nr. →1H..SP352189, →1H..SB088704, →1H..SW385334	JBH,LLE	0986 480 878	23,8
		02.95-02.99	66	Fg.-Nr. 1H..SB088 705→, 1H..SP352 190→, 1H..SW385 335→	JBH,LLE	0986 480 987	23,81
					JBH,RLE	0986 481 016	22,2
		02.96-02.99	81	Fg.-Nr. 1H..SB088 705→, 1H..SP352 190→, 1H..SW385 335→	JBH,LLE	0986 480 987	23,81
					JBH,RLE	0986 481 016	22,2
					JBH,RLE	0986 480 869	22
1.9 TDI syncro	ABS	02.95-07.96	66	Fg.-Nr. 1H..SW385 335→	JBH	0986 480 987	23,81
		05.96-12.97	66		JBH	0986 480 987	23,81
2.0	ABS	07.93-01.95	85	Fg.-Nr. →1H..SP352189, →1H..SB088704, →1H..SW385334	JBH,LLE	0986 480 878	23,8
		02.95-02.99	85	Fg.-Nr. 1H..SB088 705→, 1H..SP352 190→, 1H..SW385 335→	JBH,LLE	0986 480 987	23,81
					JBH,RLE	0986 481 016	22,2
					JBH,RLE	0986 480 869	22
2.0, syncro	ABO	07.93-02.99	85		JBH	F 026 003 563	22
2.0 syncro	ABS	07.95-12.97	85		JBH	0986 480 987	23,81
2.9 syncro	ABO	07.95-12.97	140		JBH	F 026 003 563	22
	ABS	07.95-12.97	140		JBH	0986 480 987	23,81

1.4	ABO	07.93-02.99	40-44		RLE	0986 485 111	
1.6	ABO	10.94-02.99	74		RLE	0986 485 111	
1.8	ABO	07.93-02.99	55/66		RLE	0986 485 111	
1.9 D, SDI, TD, TDI	ABO	07.93-02.99	47/55/66/81		RLE	0986 485 111	
2.0	ABO	07.93-02.99	85		RLE	0986 485 111	



















1.4		07.93-02.99	40-44		LLE	0986 486 038	19
					RLE	0986 486 045	19,05
1.6		10.94-02.99	74		LLE	0986 486 038	19
					RLE	0986 486 045	19,05
1.8		07.93-02.99	55/66		RLE	0986 486 045	19,05
1.8, syncro		07.93-02.99	55/66		LLE	0986 486 038	19
1.9 D		07.93-02.99	47		LLE	0986 486 038	19
					RLE	0986 486 045	19,05
1.9 SDI		01.95-02.99	47		LLE	0986 486 146	15,87
1.9 TD, TDI		07.93-02.99	55/66/81		RLE	0986 486 045	19,05
1.9 TD, TDI, TDI syncro		07.93-02.99	55/66/81		LLE	0986 486 038	19
2.0		07.93-02.99	85		RLE	0986 486 045	19,05
2.0, syncro		07.93-02.99	85		LLE	0986 486 038	19
2.9 syncro		07.95-12.97	140		LLE	0986 486 038	19

		S							
	1.4		07.93-02.99	40-44			0 986 486 537	23,8	
	1.6		10.94-02.99	74			0 986 486 537	23,8	
	1.8, syncro		07.93-02.99	55/66			0 986 486 537	23,8	
	1.9 D, TD, TDI, TDI syncro		07.93-02.99	47/55/66/81			0 986 486 537	23,8	
	2.0, syncro		07.93-02.99	85			0 986 486 537	23,8	
	2.9 syncro		07.95-12.97	140			0 986 486 537	23,8	
	1.4		07.93-02.99	40-44		SBR	0 204 131 697 ^A		
						TBR	0 986 482 007 ^A		
	1.6		10.94-02.99	74		SBR	0 204 131 697 ^A		
						TBR	0 986 482 007 ^A		
	1.8		07.93-02.99	55		SBR	0 204 131 697 ^A		
				66		TBR	0 986 482 007 ^A		
						SBR	0 204 131 697 ^A		
						TBR	0 986 482 007 ^A		
	1.8 syncro		10.94-12.97	66			0 986 482 007 ^A		
	1.9 D, SDI, TD		07.93-02.99	47/55		SBR	0 204 131 697 ^A		
						TBR	0 986 482 007 ^A		
	1.9 TDI		07.93-02.99	66		SBR	0 204 131 697 ^A		
						TBR	0 986 482 007 ^A		
			02.96-02.99	81		SBR	0 204 131 697 ^A		
						TBR	0 986 482 007 ^A		
	1.9 TDI syncro		10.94-12.97	66			0 986 482 007 ^A		
	2.0		07.93-02.99	85		SBR	0 204 131 697 ^A		
						TBR	0 986 482 007 ^A		
	2.0 syncro		07.95-12.97	85			0 986 482 007 ^A		
	2.9 syncro		07.95-12.97	140			0 986 482 006 ^A		
Golf III [1H1]									
	City Stromer	ABS	02.95-12.97	17,5-22	Fg.-Nr. 1H..SB088 705→, 1H..SP352 190→, 1H..SW385 335→	JBH ,LLE	0 986 481 016	22,2	
	1.4	ABO	11.91-12.97	40-44		JBH	F 026 003 562	20,6	
		ABS	02.95-12.97	40-44	Fg.-Nr. 1H..SB088 705→, 1H..SP352 190→, 1H..SW385 335→	JBH ,LLE	0 986 480 987	23,81	
						JBH ,RLE	0 986 480 869	22	
	1.6	ABO	09.92-12.97	55		JBH	F 026 003 562	20,6	
			10.94-12.97	74		JBH	F 026 003 563	22	
			05.97-12.97	74		JBH	F 026 003 562	20,6	
		ABS	10.94-01.95	74	Fg.-Nr. →1H..SP352189, →1H..SB088704, →1H..SW385334	JBH ,LLE	0 986 480 878	23,8	
			02.95-12.97	55	Fg.-Nr. 1H..SB088 705→, 1H..SP352 190→, 1H..SW385 335→	JBH ,LLE	0 986 480 987	23,81	
						JBH ,RLE	0 986 480 869	22	
				74	Fg.-Nr. 1H..SB088 705→, 1H..SP352 190→, 1H..SW385 335→	JBH ,LLE	0 986 480 987	23,81	
						JBH ,RLE	0 986 481 016	22,2	
						JBH ,RLE	0 986 480 869	22	
	1.8	ABO	11.91-12.97	55/66		JBH	F 026 003 562	20,6	
							F 026 003 563	22	
		ABS	11.91-01.95	66	Fg.-Nr. →1H..SP352189, →1H..SB088704, →1H..SW385334	JBH ,LLE	0 986 480 878	23,8	
			02.95-12.97	55	Fg.-Nr. 1H..SB088 705→, 1H..SP352 190→, 1H..SW385 335→	JBH ,LLE	0 986 480 987	23,81	
						JBH ,RLE	0 986 481 016	22,2	
				66	Fg.-Nr. 1H..SB088 705→, 1H..SP352 190→, 1H..SW385 335→	JBH ,LLE	0 986 480 987	23,81	
						JBH ,RLE	0 986 481 016	22,2	
						JBH ,RLE	0 986 480 869	22	

		S							
◀ VW Golf III [1H1]									
1.8 syncro	ABO	01.93-12.97	55/66			JBH	F 026 003 563	22	
	ABS	02.95-12.97	66	Fg.-Nr. 1H..SW385 335→		JBH	0 986 480 987	23,81	
1.9 D	ABO	11.91-12.97	47/55			JBH	F 026 003 562	20,6	
1.9 SDI	ABS	02.95-12.97	47/55	Fg.-Nr. 1H..SB088 705→,		JBH,LLE	0 986 480 987	23,81	
	1.9 TD			1H..SP352 190→,			0 986 481 016	22,2	
				1H..SW385 335→		JBH,RLE	0 986 480 869	22	
1.9 TDI	ABO	09.93-12.97	66			JBH	F 026 003 563	22	
		03.96-12.97	81			JBH	F 026 003 563	22	
		08.96-12.97	66			JBH	F 026 003 562	20,6	
	ABS	09.93-01.95	66	Fg.-Nr. →1H..SP352189,		JBH,LLE	0 986 480 878	23,8	
				→1H..SB088704,					
				→1H..SW385334					
		02.95-12.97	66	Fg.-Nr. 1H..SB088 705→,		JBH,LLE	0 986 480 987	23,81	
				1H..SP352 190→,			0 986 481 016	22,2	
				1H..SW385 335→		JBH,RLE	0 986 480 869	22	
		03.96-12.97	81	Fg.-Nr. 1H..SB088 705→,		JBH,LLE	0 986 480 987	23,81	
				1H..SP352 190→,			0 986 481 016	22,2	
				1H..SW385 335→		JBH,RLE	0 986 480 869	22	
1.9 TDI syncro	ABO	03.95-12.97	66			JBH	F 026 003 563	22	
	ABS	03.95-12.97	66			JBH	0 986 480 987	23,81	
2.0	ABS	11.91-01.95	85	Fg.-Nr. →1H..SP352189,		JBH,LLE	0 986 480 878	23,8	
				→1H..SB088704,					
				→1H..SW385334					
		08.92-01.95	110	Fg.-Nr. →1H..SP352189,		JBH,LLE	0 986 480 878	23,8	
				→1H..SB088704,					
				→1H..SW385334					
		01.95-01.95	79	Fg.-Nr. →1H..SP352189,		JBH,LLE	0 986 480 878	23,8	
				→1H..SB088704,					
				→1H..SW385334					
		02.95-12.97	79	Fg.-Nr. 1H..SB088 705→,		JBH,LLE	0 986 480 987	23,81	
			1H..SP352 190→,			0 986 481 016	22,2		
			1H..SW385 335→		JBH,RLE	0 986 480 869	22		
			85	Fg.-Nr. 1H..SB088 705→,		JBH,LLE	0 986 480 987	23,81	
				1H..SP352 190→,			0 986 481 016	22,2	
				1H..SW385 335→		JBH,RLE	0 986 480 869	22	
			110	Fg.-Nr. 1H..SB088 705→,		JBH,LLE	0 986 480 987	23,81	
				1H..SP352 190→,			0 986 481 016	22,2	
				1H..SW385 335→		JBH,RLE	0 986 480 869	22	
2.0, syncro	ABO	11.91-12.97	79/85/110			JBH	F 026 003 563	22	
2.0 syncro	ABS	07.95-12.97	85			JBH	0 986 480 987	23,81	
2.8	ABO	01.92-12.97	120/128			JBH	F 026 003 562	20,6	
							F 026 003 563	22	
	ABS	01.92-01.95	120/128	Fg.-Nr. →1H..SP352189,		JBH,LLE	0 986 480 878	23,8	
				→1H..SB088704,					
				→1H..SW385334					
		02.95-12.97	120/128	Fg.-Nr. 1H..SB088 705→,		JBH,LLE	0 986 480 987	23,81	
				1H..SP352 190→,			0 986 481 016	22,2	
				1H..SW385 335→		JBH,RLE	0 986 480 869	22	
2.9 syncro	ABO	01.94-12.97	140			JBH	F 026 003 563	22	
	ABS	01.94-01.95	140	Fg.-Nr. →1H..SW385334		JBH	0 986 480 878	23,8	
		02.95-12.97	140	Fg.-Nr. 1H..SW385 335→		JBH	0 986 480 987	23,81	
	1.4		11.91-12.97	40-44		RLE	0 986 485 111		
	1.6		09.92-12.97	55/74		RLE	0 986 485 111		
	1.8		11.91-12.97	55/66		RLE	0 986 485 111		
	1.9 D, SDI, TD, TDI		11.91-12.97	47/55/66/81		RLE	0 986 485 111		
	2.0		11.91-12.97	79/85/110		RLE	0 986 485 111		
2.8		01.92-12.97	120/128		RLE	0 986 485 111			
	1.4		11.91-12.97	40-44		LLE	0 986 486 038	19	
						RLE	0 986 486 045	19,05	
	1.6		09.92-12.97	55/74		LLE	0 986 486 038	19	
					RLE	0 986 486 045	19,05		

	S							
1.8	11.91-12.97	55/66			RLE	0 986 486 045	19,05	
1.8, syncro	11.91-12.97	55/66			LLE	0 986 486 038	19	
1.9D	11.91-12.97	47			LLE	0 986 486 038	19	
					RLE	0 986 486 045	19,05	
1.9SDI	01.95-12.97	47			LLE	0 986 486 146	15,87	
1.9TD	11.91-12.97	55			LLE	0 986 486 038	19	
					RLE	0 986 486 045	19,05	
1.9TDI	09.93-12.97	66			LLE	0 986 486 038	19	
					RLE	0 986 486 045	19,05	
	03.96-12.97	81			LLE	0 986 486 038	19	
					RLE	0 986 486 045	19,05	
1.9TDI syncro	03.95-12.97	66			LLE	0 986 486 038	19	
	05.96-12.97	66				0 986 486 038	19	
2.0	11.91-12.97	79/85/110			RLE	0 986 486 045	19,05	
2.0, syncro	11.91-12.97	79/85/110			LLE	0 986 486 038	19	
2.8	01.92-12.97	120/128			LLE	0 986 486 038	19	
					RLE	0 986 486 045	19,05	
2.9 syncro	01.94-12.97	140			LLE	0 986 486 038	19	
 1.4	11.91-12.97	40-44				0 986 486 537	23,8	
1.6	09.92-12.97	55/74				0 986 486 537	23,8	
1.8, syncro	11.91-12.97	55/66				0 986 486 537	23,8	
1.9D, TD, TDI, TDI syncro	11.91-12.97	47/55/66/81				0 986 486 537	23,8	
2.0, syncro	11.91-12.97	79/85/110				0 986 486 537	23,8	
2.8	01.92-12.97	120/128				0 986 486 537	23,8	
2.9 syncro	01.94-12.97	140				0 986 486 537	23,8	
 1.4	11.91-12.97	40-44			SBR	0 204 131 697 ^A		
					TBR	0 986 482 007 ^A		
1.6	09.92-12.97	55/74			SBR	0 204 131 697 ^A		
					TBR	0 986 482 007 ^A		
1.8	11.91-12.97	55			SBR	0 204 131 697 ^A		
					TBR	0 986 482 007 ^A		
		66			SBR	0 204 131 697 ^A		
					TBR	0 986 482 007 ^A		
1.8 syncro	01.93-12.97	66			NIV	0 986 482 006 ^A		
1.9D, SDI, TD	11.91-12.97	47/55			SBR	0 204 131 697 ^A		
					TBR	0 986 482 007 ^A		
1.9TDI	09.93-12.97	66			SBR	0 204 131 697 ^A		
					TBR	0 986 482 007 ^A		
	03.96-12.97	81			SBR	0 204 131 697 ^A		
					TBR	0 986 482 007 ^A		
1.9TDI syncro	03.95-12.97	66			NIV	0 986 482 006 ^A		
	05.96-12.97	66				0 986 482 006 ^A		
2.0	11.91-12.97	85			SBR	0 204 131 697 ^A		
					TBR	0 986 482 007 ^A		
	08.92-12.97	110			SBR	0 204 131 697 ^A		
					TBR	0 986 482 007 ^A		
	01.95-12.97	79			SBR	0 204 131 697 ^A		
					TBR	0 986 482 007 ^A		
2.0 syncro	07.95-12.97	85			NIV	0 986 482 006 ^A		
2.8	01.92-12.97	120/128			SBR	0 204 131 697 ^A		
2.9 syncro	01.94-12.97	140			NIV	0 986 482 006 ^A		
Golf III [1H1/1W1]								
								
 1.8	ABO	08.92-07.99	66		JBH	F 026 003 562	20,6	
1.9TD		08.92-07.98	55		JBH	F 026 003 562	20,6	
2.0	ABO	08.92-07.99	85		JBH	F 026 003 563	22	

		S							
◀ VW Golf III [1H1/1W1]									
	1.8		08.92-07.99	66		SBR	0 204 131 697 ^A		
						TBR	0986 482 007 ^A		
	1.9 TD		08.92-07.98	55			0986 482 007 ^A		
	2.8		09.94-08.99	128		SBR	0 204 131 697 ^A		
						TBR	0986 482 007 ^A		
Golf III [1H4]									
	1.8	ABO	11.92-12.99	70		RLE	0986 485 111		
	Golf IV								
	1.8 i		08.03-07.08	92			F 026 003 339	23,81	
	1.9 TDI 4Motion	MFD	04.01-06.05	96	JBH,LLE,M20	0986 481 022	23,81		
		OFD	04.01-06.05	96	LLE	F 026 003 339	23,81		
					RLE	0 204 123 406	23,81		
	1.9 TDI 4Motion	OFD	04.01-06.05	96		RLE	0 204 125 505		
		1.9 TDI 4Motion	04.01-04.01	96		RLE	0986 486 047	15,87	
04.01-06.05			96		LLE	0986 486 031	15,87		
	1.9 TDI 4Motion	04.01-06.05	96		FSG	0986 486 542	23,81		
				Get.-Nr. MQ-350	MG6	0986 486 595	29		
				PR-Code OEM	FSZ,MG5	0986 486 554	19,05		
				PR-Code OEJ	FSZ,MG5	0986 486 576	19		
Golf IV Cabriolet [1E7]									
	1.6		04.98-10.00	74	JBH,LLE	0986 480 987	23,81		
		ABO	04.98-10.00	74	JBH,RLE	F 026 003 563	22		
	1.8		04.98-10.00	55/66	JBH,LLE	0986 480 987	23,81		
		ABO	04.98-10.00	55/66	JBH,RLE	F 026 003 563	22		
	1.9 TDI		04.98-12.01	66/81	JBH,LLE	0986 480 987	23,81		
		ABO	04.98-12.01	66/81	JBH,RLE	F 026 003 563	22		
	2.0		04.98-06.02	85	JBH,LLE	0986 480 987	23,81		
		ABO	04.98-06.02	85	JBH,RLE	F 026 003 563	22		
	1.6		04.98-10.00	74	LLE	0986 486 038	19		
					RLE	0986 486 045	19,05		
	1.8		04.98-10.00	55/66	LLE	0986 486 038	19		
					RLE	0986 486 045	19,05		
	1.9 TDI		04.98-12.01	66/81	LLE	0986 486 038	19		
					RLE	0986 486 045	19,05		
	2.0		04.98-06.02	85	LLE	0986 486 038	19		
					RLE	0986 486 045	19,05		
	1.6		04.98-10.00	74		0986 486 537	23,8		
						0986 486 537	23,8		
	1.8		04.98-10.00	55/66		0986 486 537	23,8		
			04.98-06.00	66		0986 486 537	23,8		
			04.98-10.00	81		0986 486 537	23,8		
			04.98-06.01	66	Fg.-Nr. →1E..2..002 000	0986 486 537	23,8		
	2.0		07.01-12.01	66	Fg.-Nr. 1E..2..002 001→	0986 486 576	19		
			04.98-06.00	85		0986 486 537	23,8		
		04.98-06.01	85	Fg.-Nr. →1E..2..002 000	0986 486 537	23,8			
		07.01-06.02	85	Fg.-Nr. 1E..2..002 001→	0986 486 576	19			

		S							
	1.9 TDI	04.98-08.99	81				0 204 131 697 ^A		
	2.0	04.98-12.01	85				0 204 131 697 ^A		
Golf IV Station Wagon [1J5]									
									
	1.6 i	ABO 01.01-12.05	74			RLE	0 204 123 406	23,81	
		ABS, 01.01-12.05	74			JBH,LLE,M20	0 986 481 022	23,81	
		MFD							
		OFD 01.01-12.05	74			LLE	F 026 003 339	23,81	
	1.6 i	OFD 01.01-12.05	74			RLE	0 204 125 505		
	1.9 TDI	OFD 04.02-12.05	81			RLE	0 204 125 505		
	1.6 i	01.01-12.05	74			LLE	0 986 486 031	15,87	
						RLE	0 986 486 047	15,87	
	1.9 TDI	04.02-12.05	81			RLE	0 986 486 047	15,87	
	1.6 i	01.01-12.05	74			FSG	0 986 486 542	23,81	
				PR-Code OEJ		FSZ	0 986 486 576	19	
		05.01-12.05	74			FSZ,MQ0	0 986 486 554	19,05	
Golf IV Variant [1J5]									
									
	1.4	MFD 05.99-06.06	55			JBH,LLE,M20	0 986 481 022	23,81	
		OFD 05.99-06.06	55			LLE	F 026 003 339	23,81	
						RLE	0 204 123 406	23,81	
	1.6	MFD 05.99-06.06	74/75/77/81			JBH,LLE,M20	0 986 481 022	23,81	
	1.6 FSI	OFD 05.99-06.06	74/75/77/81			LLE	F 026 003 339	23,81	
						RLE	0 204 123 406	23,81	
	1.8 T	MFD 05.99-05.03	92/110			JBH,LLE,M20	0 986 481 022	23,81	
	1.8 4Motion	OFD 05.99-05.03	92/110			LLE	F 026 003 339	23,81	
						RLE	0 204 123 406	23,81	
	1.9 SDI	MFD 05.99-06.06	50/66/74/81/85/96			JBH,LLE,M20	0 986 481 022	23,81	
	1.9 TDI	OFD 05.99-06.06	50/66/74/81/85/96			LLE	F 026 003 339	23,81	
	1.9 TDI 4Motion					RLE	0 204 123 406	23,81	
	2.0	MFD 05.99-06.06	85			JBH,LLE,M20	0 986 481 022	23,81	
	2.0 BiFuel	OFD 05.99-06.06	85			LLE	F 026 003 339	23,81	
	2.0 4Motion					RLE	0 204 123 406	23,81	
	2.3	MFD 05.99-06.06	110/125			JBH,LLE,M20	0 986 481 022	23,81	
	2.3 4Motion	OFD 05.99-06.06	110/125			LLE	F 026 003 339	23,81	
						RLE	0 204 123 406	23,81	
	2.8 4Motion	MFD 05.99-06.06	150			JBH,LLE,M20	0 986 481 022	23,81	
		OFD 05.99-06.06	150			LLE	F 026 003 339	23,81	
						RLE	0 204 123 406	23,81	
	1.4	OFD 05.99-06.06	55			RLE	0 204 125 505		
	1.6, FSI	OFD 05.99-06.06	74/75/77/81			RLE	0 204 125 505		
	1.8 T, 4Motion	OFD 05.99-05.03	92/110			RLE	0 204 125 505		
	1.9 SDI, TDI, TDI 4Motion	OFD 05.99-06.06	50/66/74/81/85/96			RLE	0 204 125 505		
	2.0, BiFuel, 4Motion	OFD 05.99-06.06	85			RLE	0 204 125 505		
	2.3, 4Motion	OFD 05.99-06.06	110/125			RLE	0 204 125 505		
	2.8 4Motion	OFD 05.99-06.06	150			RLE	0 204 125 505		
	1.4	05.99-04.01	55			RLE	0 986 486 047	15,87	
		05.99-06.06	55			LLE	0 986 486 031	15,87	
	1.6	05.99-04.01	74/75/77			RLE	0 986 486 047	15,87	
		05.99-06.06	74/75/77			LLE	0 986 486 031	15,87	
	1.6 FSI	08.01-06.06	81			LLE	0 986 486 031	15,87	
	1.8 T	05.99-04.01	92/110			RLE	0 986 486 047	15,87	
	1.8 4Motion	05.99-05.03	92/110			LLE	0 986 486 031	15,87	



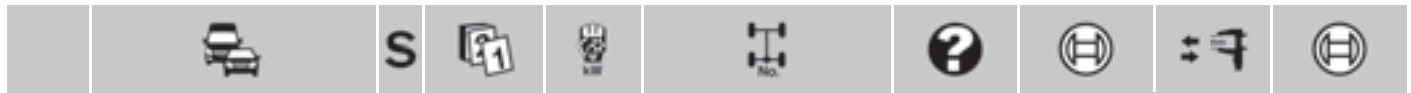











VW Golf IV Variant [1J5]							
1.9 SDI	05.99-04.01	50/66/74/81/85/96		RLE	0 986 486 047	15,87	
1.9 TDI	05.99-06.06	50/66/74/81/85/96		LLE	0 986 486 031	15,87	
1.9 TDI 4Motion							
2.0, BiFuel, 4Motion	05.99-06.06	85		LLE	0 986 486 031	15,87	
2.0, 4Motion	05.99-04.01	85		RLE	0 986 486 047	15,87	
2.3	05.99-04.01	110/125		RLE	0 986 486 047	15,87	
2.3 4Motion	05.99-06.06	110/125		LLE	0 986 486 031	15,87	
2.8 4Motion	05.99-04.01	150		RLE	0 986 486 047	15,87	
	05.99-06.06	150		LLE	0 986 486 031	15,87	
1.4	05.99-06.06	55		FSG	0 986 486 542	23,81	
			Get.-Nr. MQ-350	MG6	0 986 486 595	29	
			PR-Code OEM	FSZ, MG5	0 986 486 554	19,05	
			PR-Code OEJ	FSZ, MG5	0 986 486 576	19	
1.6	05.99-06.06	74/75/77/		FSG	0 986 486 542	23,81	
1.6 FSI		81		Get.-Nr. MQ-350	MG6	0 986 486 595	29
			PR-Code OEM	FSZ, MG5	0 986 486 554	19,05	
			PR-Code OEJ	FSZ, MG5	0 986 486 576	19	
1.8 T	05.99-05.03	92/110		FSG	0 986 486 542	23,81	
1.8 4Motion				Get.-Nr. MQ-350	MG6	0 986 486 595	29
			PR-Code OEM	FSZ, MG5	0 986 486 554	19,05	
			PR-Code OEJ	FSZ, MG5	0 986 486 576	19	
1.9 SDI	05.99-06.06	50/66/74/		FSG	0 986 486 542	23,81	
1.9 TDI		81/85/96		Get.-Nr. MQ-350	MG6	0 986 486 595	29
1.9 TDI 4Motion				PR-Code OEM	FSZ, MG5	0 986 486 554	19,05
				PR-Code OEJ	FSZ, MG5	0 986 486 576	19
2.0	05.99-06.06	85		FSG	0 986 486 542	23,81	
2.0 BiFuel				Get.-Nr. MQ-350	MG6	0 986 486 595	29
2.0 4Motion				PR-Code OEM	FSZ, MG5	0 986 486 554	19,05
				PR-Code OEJ	FSZ, MG5	0 986 486 576	19
2.3	05.99-06.06	110/125		FSG	0 986 486 542	23,81	
2.3 4Motion				Get.-Nr. MQ-350	MG6	0 986 486 595	29
				PR-Code OEM	FSZ, MG5	0 986 486 554	19,05
				PR-Code OEJ	FSZ, MG5	0 986 486 576	19
2.8 4Motion	05.99-06.06	150		FSG	0 986 486 542	23,81	
				Get.-Nr. MQ-350	MG6	0 986 486 595	29
				PR-Code OEM	FSZ, MG5	0 986 486 554	19,05
				PR-Code OEJ	FSZ, MG5	0 986 486 576	19









Golf IV [1J1]

1.4	MFD 10.97-05.04	55		JBH, LLE, M20	0 986 481 022	23,81	
	OFD 10.97-05.04	55		LLE	F 026 003 339	23,81	
				RLE	0 204 123 406	23,81	
1.6	MFD 10.97-05.04	74		JBH, LLE, M20	0 986 481 022	23,81	
	OFD 10.97-05.04	74		RLE	0 204 123 406	23,81	
1.6	MFD 11.99-05.04	75/77/81		JBH, LLE, M20	0 986 481 022	23,81	
1.6 FSI	OFD 11.99-05.04	75/77/81		LLE	F 026 003 339	23,81	
				RLE	0 204 123 406	23,81	
1.6, i	OFD 10.97-12.05	74		LLE	F 026 003 339	23,81	
1.6 i	ABO 10.97-12.05	74		RLE	0 204 123 406	23,81	
	ABS, 10.97-12.05	74		JBH, LLE,	0 986 481 022	23,81	
	MFD			M20			
1.8	MFD 10.97-10.00	92		JBH, LLE, M20	0 986 481 022	23,81	
	OFD 10.97-10.00	92		RLE	0 204 123 406	23,81	
1.8, i, 4Motion	OFD 10.97-10.00	92		LLE	F 026 003 339	23,81	
1.8 i	ABO 02.99-08.00	92		RLE	0 204 123 406	23,81	
	ABS, 02.99-08.00	92		JBH, LLE,	0 986 481 022	23,81	
	MFD			M20			
1.8 T	ABO 02.99-12.05	110		RLE	0 204 123 406	23,81	
	ABS, 02.99-12.05	110		JBH, LLE,	0 986 481 022	23,81	
	MFD			M20			



		S							
1.8 T	MFD	10.97-05.03	110			JBH,LLE,M20	0 986 481 022	23,81	
		06.01-05.04	132			JBH,LLE,M20	0 986 481 022	23,81	
	OFD	10.97-05.03	110			RLE	0 204 123 406	23,81	
		10.97-12.05	110			LLE	F 026 003 339	23,81	
		06.01-05.04	132			LLE	F 026 003 339	23,81	
						RLE	0 204 123 406	23,81	
1.8 4Motion	MFD	07.98-10.00	92			JBH,LLE,M20	0 986 481 022	23,81	
	OFD	07.98-10.00	92			RLE	0 204 123 406	23,81	
1.9 SDI	MFD	10.97-06.05	50/66/74			JBH,LLE,M20	0 986 481 022	23,81	
1.9 TDI	OFD	10.97-06.05	50/66/74			LLE	F 026 003 339	23,81	
1.9 TDI 4Motion						RLE	0 204 123 406	23,81	
1.9 TDI	ABO	05.00-12.05	81			RLE	0 204 123 406	23,81	
	ABS,	05.00-12.05	81			JBH,LLE,	0 986 481 022	23,81	
	MFD					M20			
		10.97-05.04	81			JBH,LLE,M20	0 986 481 022	23,81	
		10.97-05.04	81			RLE	0 204 123 406	23,81	
		10.97-12.05	81			LLE	F 026 003 339	23,81	
1.9 TDI	MFD	05.99-06.05	85/96/110			JBH,LLE,M20	0 986 481 022	23,81	
1.9 TDI 4Motion	OFD	05.99-06.05	85/96/110			LLE	F 026 003 339	23,81	
						RLE	0 204 123 406	23,81	
2.0	MFD	08.98-08.00	85			JBH,LLE	0 986 481 022	23,81	
		08.98-05.04	85			JBH,LLE,M20	0 986 481 022	23,81	
2.0, BiFuel	OFD	08.98-05.04	85			RLE	0 204 123 406	23,81	
2.0, BiFuel, i, 4Motion	OFD	08.98-12.05	85			LLE	F 026 003 339	23,81	
2.0 BiFuel	MFD	05.02-05.03	85			JBH,LLE,M20	0 986 481 022	23,81	
2.0 i	ABO	02.99-12.05	85			RLE	0 204 123 406	23,81	
	ABS,	02.99-12.05	85			JBH,LLE,	0 986 481 022	23,81	
	MFD					M20			
2.0 4Motion	MFD	04.00-06.05	85			JBH,LLE,M20	0 986 481 022	23,81	
	OFD	04.00-06.05	85			RLE	0 204 123 406	23,81	
2.3	MFD	10.97-06.05	110/125			JBH,LLE,M20	0 986 481 022	23,81	
2.3 4Motion	OFD	10.97-06.05	110/125			LLE	F 026 003 339	23,81	
						RLE	0 204 123 406	23,81	
2.8 4Motion	MFD	05.99-04.01	150			JBH,LLE,M20	0 986 481 022	23,81	
	OFD	05.99-06.05	150			LLE	F 026 003 339	23,81	
						RLE	0 204 123 406	23,81	
3.2 4Motion R32	MFD	10.03-05.04	177			JBH,LLE,M20	0 986 481 022	23,81	
	OFD	06.02-05.04	177			LLE	F 026 003 339	23,81	
						RLE	0 204 123 406	23,81	
	1.4	OFD	10.97-05.04	55		RLE	0 204 125 505		
	1.6, FSI, i	OFD	10.97-12.05	74/75/77/81		RLE	0 204 125 505		
	1.8, i, T, 4Motion	OFD	10.97-12.05	92/110/132		RLE	0 204 125 505		
	1.9 SDI, TDI, TDI 4Motion	OFD	10.97-12.05	50/66/74/81/85/96/110		RLE	0 204 125 505		
	2.0, BiFuel, i, 4Motion	OFD	08.98-12.05	85		RLE	0 204 125 505		
	2.3, 4Motion	OFD	10.97-06.05	110/125		RLE	0 204 125 505		
	2.8 4Motion	OFD	05.99-06.05	150		RLE	0 204 125 505		
	3.2 4Motion R32	OFD	06.02-05.04	177		RLE	0 204 125 505		
	1.4		10.97-04.01	55		RLE	0 986 486 047	15,87	
			10.97-05.04	55		LLE	0 986 486 031	15,87	
	1.6		10.97-04.01	74		RLE	0 986 486 047	15,87	
			11.99-04.01	75/77		RLE	0 986 486 047	15,87	
			11.99-05.04	75/77		LLE	0 986 486 031	15,87	
	1.6, i		10.97-12.05	74		LLE	0 986 486 031	15,87	
	1.6 FSI		08.01-05.04	81		LLE	0 986 486 031	15,87	
	1.6 i		10.97-12.05	74		RLE	0 986 486 047	15,87	
	1.8, i, 4Motion		10.97-10.00	92		LLE	0 986 486 031	15,87	
						RLE	0 986 486 047	15,87	
	1.8 T		10.97-12.05	110		LLE	0 986 486 031	15,87	
						RLE	0 986 486 047	15,87	
			06.01-05.04	132		LLE	0 986 486 031	15,87	
			05.03-12.05	132		RLE	0 986 486 047	15,87	





		S								
VW Golf IV [1J1]										
1.9 SDI, TDI, TDI 4Motion	10.97-04.01	50/66/74			RLE	0 986 486 047	15,87			
	10.97-06.05	50/66/74			LLE	0 986 486 031	15,87			
1.9 TDI	10.97-12.05	81			LLE	0 986 486 031	15,87			
					RLE	0 986 486 047	15,87			
1.9 TDI	05.99-04.01	85/96/110			RLE	0 986 486 047	15,87			
1.9 TDI 4Motion	05.99-06.05	85/96/110			LLE	0 986 486 031	15,87			
2.0	08.98-04.01	85			RLE	0 986 486 047	15,87			
2.0, BiFuel, i, 4Motion	08.98-12.05	85			LLE	0 986 486 031	15,87			
2.0 i	02.99-12.05	85			RLE	0 986 486 047	15,87			
2.0 4Motion	04.00-04.01	85			RLE	0 986 486 047	15,87			
2.3	10.97-04.01	110/125			RLE	0 986 486 047	15,87			
2.3 4Motion	10.97-06.05	110/125			LLE	0 986 486 031	15,87			
2.8 4Motion	05.99-04.01	150			RLE	0 986 486 047	15,87			
	05.99-06.05	150			LLE	0 986 486 031	15,87			
3.2 4Motion R32	06.02-05.04	177			LLE	0 986 486 031	15,87			
1.4	10.97-05.04	55		Get.-Nr. MQ-350	MG6	0 986 486 542	23,81			
				PR-Code OEM	FSZ, MG5	0 986 486 554	19,05			
				PR-Code OEJ	FSZ, MG5	0 986 486 576	19			
1.6	10.97-05.04	74		Get.-Nr. MQ-350	MG6	0 986 486 595	29			
				PR-Code OEM	FSZ, MG5	0 986 486 554	19,05			
				PR-Code OEJ	FSZ, MG5	0 986 486 576	19			
	09.00-05.04	75			FSG	0 986 486 542	23,81			
				Get.-Nr. MQ-350	MG6	0 986 486 595	29			
				PR-Code OEM	FSZ, MG5	0 986 486 554	19,05			
			PR-Code OEJ	FSZ, MG5	0 986 486 576	19				
	05.02-05.04	75			FSZ	0 986 486 554	19,05			
1.6	11.99-05.04	77/81			FSG	0 986 486 542	23,81			
1.6 FSI				Get.-Nr. MQ-350	MG6	0 986 486 595	29			
				PR-Code OEM	FSZ, MG5	0 986 486 554	19,05			
				PR-Code OEJ	FSZ, MG5	0 986 486 576	19			
1.6, i	10.97-12.05	74			FSG	0 986 486 542	23,81			
1.6 i	10.97-12.05	74		PR-Code OEJ	FSZ	0 986 486 576	19			
	05.01-12.05	74			FSZ, MQ0	0 986 486 554	19,05			
1.8	10.97-10.00	92		PR-Code OEJ	FSZ, MG5	0 986 486 576	19			
1.8, i, 4Motion	10.97-10.00	92			FSG	0 986 486 542	23,81			
1.8	10.97-10.00	92		Get.-Nr. MQ-350	MG6	0 986 486 595	29			
				PR-Code OEM	FSZ, MG5	0 986 486 554	19,05			
1.8 4Motion				PR-Code OEJ	FSZ, MG5	0 986 486 576	19			
1.8 i	02.99-08.00	92		PR-Code OEJ	FSZ	0 986 486 576	19			
1.8 T	10.97-05.03	110		Get.-Nr. MQ-350	MG6	0 986 486 595	29			
				PR-Code OEM	FSZ, MG5	0 986 486 554	19,05			
				PR-Code OEJ	FSZ, MG5	0 986 486 576	19			
		10.97-12.05	110			FSG	0 986 486 542	23,81		
		02.99-12.05	110		PR-Code OEJ	FSZ	0 986 486 576	19		
		05.01-12.05	110			FSZ, MQ0	0 986 486 554	19,05		
		06.01-05.04	132			FSG	0 986 486 542	23,81		
					Get.-Nr. MQ-350	MG6	0 986 486 595	29		
				PR-Code OEM	FSZ, MG5	0 986 486 554	19,05			
				PR-Code OEJ	FSZ, MG5	0 986 486 576	19			
1.8 4Motion	07.98-10.00	92		PR-Code OEJ	FSZ, MG5	0 986 486 576	19			
1.9 SDI	10.97-06.05	50/66/74			FSG	0 986 486 542	23,81			
1.9 TDI				Get.-Nr. MQ-350	MG6	0 986 486 595	29			
				PR-Code OEM	FSZ, MG5	0 986 486 554	19,05			
				PR-Code OEJ	FSZ, MG5	0 986 486 576	19			
1.9 TDI	10.97-05.04	81		Get.-Nr. MQ-350	MG6	0 986 486 595	29			
				PR-Code OEM	FSZ, MG5	0 986 486 554	19,05			
				PR-Code OEJ	FSZ, MG5	0 986 486 576	19			
		10.97-12.05	81			FSG	0 986 486 542	23,81		
		05.00-12.05	81		PR-Code OEJ	FSZ	0 986 486 576	19		
		05.01-12.05	81			FSZ, MQ0	0 986 486 554	19,05		

		S							
1.9 TDI		05.99-06.05	85/96/110			FSG	0 986 486 542	23,81	
1.9 TDI 4Motion					Get.-Nr. MQ-350	MG6	0 986 486 595	29	
					PR-Code OEM	FSZ, MG5	0 986 486 554	19,05	
					PR-Code OEJ	FSZ, MG5	0 986 486 576	19	
2.0		08.98-05.04	85			FSZ	0 986 486 554	19,05	
					PR-Code OEM	FSZ, MG5	0 986 486 554	19,05	
2.0, BiFuel		08.98-05.04	85		PR-Code OEJ	FSZ, MG5	0 986 486 576	19	
2.0, BiFuel, i, 4Motion		08.98-12.05	85			FSG	0 986 486 542	23,81	
2.0, BiFuel, 4Motion		08.98-06.05	85		Get.-Nr. MQ-350	MG6	0 986 486 595	29	
2.0 BiFuel		05.02-05.03	85		PR-Code OEM	FSZ, MG5	0 986 486 554	19,05	
2.0 i		02.99-12.05	85		PR-Code OEJ	FSZ	0 986 486 576	19	
		05.01-12.05	85			FSZ, MQ0	0 986 486 554	19,05	
2.0 4Motion		04.00-06.05	85		PR-Code OEM	FSZ, MG5	0 986 486 554	19,05	
					PR-Code OEJ	FSZ, MG5	0 986 486 576	19	
2.3		09.00-05.04	125			FSZ	0 986 486 554	19,05	
2.3		10.97-02.01	110			FSG	0 986 486 542	23,81	
2.3 4Motion					Get.-Nr. MQ-350	MG6	0 986 486 595	29	
					PR-Code OEM	FSZ, MG5	0 986 486 554	19,05	
					PR-Code OEJ	FSZ, MG5	0 986 486 576	19	
		09.00-06.05	125			FSG	0 986 486 542	23,81	
2.3 4Motion		09.00-06.05	125		Get.-Nr. MQ-350	MG6	0 986 486 595	29	
					PR-Code OEM	FSZ, MG5	0 986 486 554	19,05	
					PR-Code OEJ	FSZ, MG5	0 986 486 576	19	
2.8 4Motion		05.99-04.01	150			FSG	0 986 486 542	23,81	
					Get.-Nr. MQ-350	MG6	0 986 486 595	29	
					PR-Code OEM	FSZ, MG5	0 986 486 554	19,05	
					PR-Code OEJ	FSZ, MG5	0 986 486 576	19	
		05.01-06.05	150				0 986 486 595	29	
3.2 4Motion R32		06.02-05.04	177				0 986 486 595	29	
		10.03-05.04	177			FSG	0 986 486 542	23,81	
					Get.-Nr. MQ-350	MG6	0 986 486 595	29	
					PR-Code OEM	FSZ, MG5	0 986 486 554	19,05	
					PR-Code OEJ	FSZ, MG5	0 986 486 576	19	

Golf IV [9B1]

								
1.6		08.99-06.01	74				F 026 003 339	23,81
1.8 GTI Turbo		08.99-03.07	110/132				F 026 003 339	23,81
2.0		08.99-03.07	85				F 026 003 339	23,81
1.6		ABO 08.99-06.01	74				0 204 125 717	
1.8 GTI Turbo		ABO 08.99-03.07	110/132				0 204 125 717	
2.0		ABO 08.99-03.07	85				0 204 125 717	

Golf Plus [5M1]

								
1.4, FSI, TSI		01.05-12.08	55/59/66/90/ 103/118/125			BO	F 026 003 715	22,2
						JBH, LLE ATE	0 986 480 870	22
1.6, FSI, MultiFuel		01.05-01.09	75/85			BO	F 026 003 715	22,2
						JBH, LLE ATE	0 986 480 870	22
1.9 TDI		01.05-01.09	66/77			BO	F 026 003 715	22,2
						JBH, LLE ATE	0 986 480 870	22
2.0 FSI		01.05-05.09	100/103/ 110			BO	F 026 003 715	22,2
2.0 TDI						JBH, LLE ATE	0 986 480 870	22
2.0 TDI		05.05-10.05	96		Fg.-Nr. →1K..6..565 000	JBH, LLE ATE	0 986 480 870	22
		05.05-05.07	96			LLE BO	F 026 003 715	22,2
		11.05-05.07	96		Fg.-Nr. 1K..6..565 001→, PR-Code 1LJ	JBH, LLE ATE	0 986 480 870	22





















◀ VW Golf Plus [5M1]

















	1.4, FSI, TSI	01.05-12.08	55/59/66/90/103/118/125		BO	0 204 055 051	
	1.6, FSI, MultiFuel	01.05-01.09	75/85		BO	0 204 055 051	
	1.9 TDI	01.05-01.09	66/77		BO	0 204 055 051	
	2.0 FSI, TDI	01.05-05.09	100/103/110		BO	0 204 055 051	
	2.0 TDI	05.05-05.07	96		LLE BO	0 204 055 051	
	1.4, FSI, TSI	01.05-12.08	55/59/66/90			0 986 486 554	19,05
	1.4 TSI	05.06-12.08	103/118/125	PR-Code OEJ		0 986 486 576	19
				PR-Code OEM		0 986 486 554	19,05
	1.6, FSI, MultiFuel	01.05-01.09	75/85			0 986 486 554	19,05
	1.9 TDI	01.05-01.09	66/77	PR-Code OEJ		0 986 486 576	19
				PR-Code OEM		0 986 486 554	19,05
	2.0 FSI	05.05-06.08	110	PR-Code OEJ		0 986 486 576	19
				PR-Code OEM		0 986 486 554	19,05
	2.0 TDI	01.05-05.09	100/103			0 986 486 595	29
		05.05-05.07	96			0 986 486 554	19,05

Golf Plus [521]

	1.2 TSI	08.09-04.11	63/77		BO	F 026 003 715	22,2
				PR-Code 1ZF	JBH,LLE ATE	0 986 480 870	22
	1.4	05.11-02.14	63/77	PR-Code 1ZF	JBH,LLE	0 986 480 870	22
		OFD 05.11-02.14	63/77	PR-Code 1ZE	JBH,LLE	0 986 480 870	22
	1.4	01.09-04.11	59		BO	F 026 003 715	22,2
				PR-Code 1ZF	JBH,LLE ATE	0 986 480 870	22
	1.4, TSI	05.11-02.14	59	PR-Code 1ZF	JBH,LLE	0 986 480 870	22
		OFD 05.11-02.14	59/90/118	PR-Code 1ZE	JBH,LLE	0 986 480 870	22
	1.4 FSI	05.09-12.10	66		BO	F 026 003 715	22,2
				PR-Code 1ZF	JBH,LLE ATE	0 986 480 870	22
	1.4 TSI	01.09-04.11	90/118		BO	F 026 003 715	22,2
				PR-Code 1ZF	JBH,LLE ATE	0 986 480 870	22
	1.6	05.11-02.14	90/118	PR-Code 1ZF	JBH,LLE	0 986 480 870	22
		01.09-04.11	66/72-75/77	PR-Code 1ZF	JBH,LLE ATE	0 986 480 870	22
	1.6	05.11-02.14	66/72-75/77	PR-Code 1ZF	JBH,LLE	0 986 480 870	22
		OFD 05.11-02.14	66/72-75/77	PR-Code 1ZE	JBH,LLE	0 986 480 870	22
	1.6, BiFuel, MultiFuel, TDI	01.09-04.11	66/72-75/77		BO	F 026 003 715	22,2
		1.6 BiFuel	05.09-04.11	66/72-75/77	PR-Code 1ZF	JBH,LLE ATE	0 986 480 870
	1.6 BiFuel	05.11-02.14	66/72-75/77	PR-Code 1ZF	JBH,LLE	0 986 480 870	22
		OFD 05.11-02.14	66/72-75/77	PR-Code 1ZE	JBH,LLE	0 986 480 870	22
	1.6 MultiFuel	01.09-04.11	66/72-75/77	PR-Code 1ZF	JBH,LLE ATE	0 986 480 870	22
		05.11-02.14	66/72-75/77	PR-Code 1ZF	JBH,LLE	0 986 480 870	22
	1.6 MultiFuel	05.11-02.14	66/72-75/77	PR-Code 1ZE	JBH,LLE	0 986 480 870	22
		OFD 05.11-02.14	66/72-75/77	PR-Code 1ZE	JBH,LLE	0 986 480 870	22
	1.6 TDI	05.09-04.11	66/72-75/77	PR-Code 1ZF	JBH,LLE ATE	0 986 480 870	22
		05.11-02.14	66/72-75/77	PR-Code 1ZF	JBH,LLE	0 986 480 870	22
	1.6 TDI	05.11-02.14	66/72-75/77	PR-Code 1ZF	JBH,LLE	0 986 480 870	22
		OFD 05.11-02.14	66/72-75/77	PR-Code 1ZE	JBH,LLE	0 986 480 870	22
	2.0 TDI	01.09-04.11	81/100/103		BO	F 026 003 715	22,2
				PR-Code 1ZF	JBH,LLE ATE	0 986 480 870	22
	2.0 TDI	05.11-02.14	81/100/103	PR-Code 1ZF	JBH,LLE	0 986 480 870	22
				PR-Code 1ZF	JBH,LLE	0 986 480 870	22

















									
2.0 TDI		OFD	05.11-02.14	81/100/103	PR-Code 1ZE	JBH,LLE	0 986 480 870	22	
 1.2 TSI			08.09-02.14	63/77			0 986 486 554	19,05	
1.4, FSI, TSI			01.09-02.14	59/66/90			0 986 486 554	19,05	
1.4 TSI			01.09-09.12	118	PR-Code OEJ		0 986 486 576	19	
					PR-Code OEM		0 986 486 554	19,05	
			05.12-02.14	118			0 986 486 576	19	
1.6, BiFuel, MultiFuel			01.09-02.14	72-75			0 986 486 554	19,05	
1.6 TDI			05.09-02.14	66			0 986 486 576	19	
				77			0 986 486 576	19	
2.0 TDI			01.09-05.10	81	PR-Code OEJ		0 986 486 576	19	
					PR-Code OEM		0 986 486 554	19,05	
			01.09-04.11	100/103			0 986 486 595	29	
			05.10-02.14	81			0 986 486 576	19	
Golf Sportsvan [AM1]									
									
 1.2 TSI			04.14→	63/81			0 986 486 554	19,05	
1.4 TSI			04.14→	92			0 986 486 554	19,05	
1.6			05.14→	81			0 986 486 554	19,05	
Golf V Variant [1K5]									
									
 1.4, TSI			05.07-07.09	59/90/103/118/125		JBH,LLE ATE	0 986 480 870	22	
1.6, MultiFuel			05.07-11.08	75		JBH,LLE ATE	0 986 480 870	22	
1.9 TDI, TDI 4Motion			05.07-06.09	77		JBH,LLE ATE	0 986 480 870	22	
2.0 GTI, TDI, TDI 4Motion			05.07-07.09	96/100/103/147		JBH,LLE ATE	0 986 480 870	22	
 1.4, TSI			05.07-07.09	59/90/103/118		LLE BO	0 204 055 051		
1.4 TSI			05.07-06.08	125		BO	0 204 055 051		
1.6, MultiFuel			05.07-11.08	75		LLE BO	0 204 055 051		
1.9 TDI			05.07-11.08	77		LLE BO	0 204 055 051		
2.0 GTI			05.07-03.09	147		BO	0 204 055 051		
			04.08-11.08	147		LLE BO	0 204 055 051		
2.0 TDI, TDI 4Motion			05.07-07.09	96/100/103		BO	0 204 055 051		
 1.4, TSI			08.07-11.08	59/90	PR-Code OEM		0 986 486 554	19,05	
1.4 TSI			05.07-06.08	103	PR-Code OEJ		0 986 486 576	19	
				125	PR-Code OEJ		0 986 486 576	19	
			07.08-07.09	118	PR-Code OEM		0 986 486 554	19,05	
1.6, MultiFuel			05.07-11.08	75	PR-Code OEM		0 986 486 554	19,05	
1.9 TDI			05.07-11.08	77	PR-Code OEJ		0 986 486 576	19	
1.9 TDI 4Motion			12.07-06.09	77			0 986 486 595	29	
2.0 GTI, TDI, TDI 4Motion			05.07-07.09	96/100/103/147			0 986 486 595	29	
Golf V [1K1]									
									
 1.4, FSI, TSI			10.03-11.08	55/59/66/90/103/125		BO	F 026 003 715	22,2	
						JBH,LLE ATE	0 986 480 870	22	
1.6			01.04-11.08	75		BO	F 026 003 715	22,2	
			06.05-11.08	75		LLE BO	F 026 003 715	22,2	
1.6, MultiFuel			01.04-11.08	75		JBH,LLE ATE	0 986 480 870	22	
1.6 FSI			10.03-07.08	85		BO	F 026 003 715	22,2	
						JBH,LLE ATE	0 986 480 870	22	
1.6 MultiFuel			11.07-11.08	75		BO	F 026 003 715	22,2	
1.9 TDI			10.03-11.08	66/77		BO	F 026 003 715	22,2	
1.9 TDI 4Motion						JBH,LLE ATE	0 986 480 870	22	

	◀ VW Golf V [1K1]									
2.0 FSI	01.04-11.08	110				BO	F 026	003 715	22,2	
	11.05-11.08	110			LLE	BO	F 026	003 715	22,2	
2.0 FSI, FSI 4Motion	01.04-11.08	110			JBH,LLE	ATE	0986	480 870	22	
2.0 FSI 4Motion	08.04-10.08	110				BO	F 026	003 715	22,2	
2.0 GTI	09.04-11.08	147				LLE	BO	F 026	003 715	22,2
	11.05-11.08	147					BO	F 026	003 715	22,2
					JBH,TW	ATE	0986	480 870	22	
	09.06-11.08	169				BO	F 026	003 715	22,2	
	03.08-11.08	147			JBH,LLE,TW		0986	480 870	22	
2.0 SDI, TDI, TDI 4Motion	10.03-11.08	55/100/103				BO	F 026	003 715	22,2	
					JBH,LLE	ATE	0986	480 870	22	
2.0 TDI	11.05-11.08	125				BO	F 026	003 715	22,2	
					JBH,LLE	ATE	0986	480 870	22	
2.5	05.07-11.08	125				BO	F 026	003 715	22,2	
					JBH,LLE	ATE	0986	480 870	22	
3.2 R32	05.05-07.07	184			LLE	BO	F 026	003 715	22,2	
3.2 R32 4Motion	11.05-11.08	184				LLE	BO	F 026	003 715	22,2
	05.07-11.08	184				BO	F 026	003 715	22,2	
	1.4	10.03-06.06	55			BO	0 204	055 051		
		05.06-11.08	59			LLE	BO	0 204	055 051	
	1.4 FSI	10.03-05.06	66			BO	0 204	055 051		
	1.4 TSI	11.05-11.08	125			BO	0 204	055 051		
		05.06-11.08	90/103			LLE	BO	0 204	055 051	
	1.6	01.04-11.08	75			BO	0 204	055 051		
		06.05-11.08	75			LLE	BO	0 204	055 051	
	1.6 FSI	10.03-07.08	85			BO	0 204	055 051		
	1.6 MultiFuel	11.07-11.08	75			LLE	BO	0 204	055 051	
	1.9 TDI	10.03-11.08	66/77			BO	0 204	055 051		
	1.9 TDI 4Motion	02.06-11.08	66/77			LLE	BO	0 204	055 051	
	2.0 FSI	01.04-11.05	110			BO	0 204	055 051		
	2.0 FSI 4Motion	11.05-11.08	110			LLE	BO	0 204	055 051	
	2.0 GTI	09.06-11.08	169			BO	0 204	055 051		
	2.0 GTI, TDI	09.04-11.08	125/147			LLE	BO	0 204	055 051	
	2.0 SDI, TDI, TDI 4Motion	10.03-11.08	55/100/103			BO	0 204	055 051		
	2.5	05.07-11.08	125			BO	0 204	055 051		
	3.2 R32	05.05-07.07	184			BO	0 204	055 051		
	3.2 R32 4Motion	11.05-11.08	184			LLE	BO	0 204	055 051	
		05.07-11.08	184			BO	0 204	055 051		
	1.4	10.03-06.06	55	PR-Code OEJ			0986	486 576	19	
					PR-Code OEM			0986	486 554	19,05
	1.4, FSI, TSI	10.03-11.08	59/66/90	PR-Code OEM			0986	486 554	19,05	
	1.4 TSI	11.05-11.08	103/125	PR-Code OEJ			0986	486 576	19	
	1.6	01.04-11.08	75	PR-Code OEM			0986	486 554	19,05	
		06.05-11.08	75				0986	486 554	19,05	
	1.6 FSI	10.03-07.08	85	PR-Code OEM			0986	486 554	19,05	
	1.6 MultiFuel	11.07-11.08	75	PR-Code OEM			0986	486 554	19,05	
	1.9 TDI	10.03-11.08	77	PR-Code OEJ			0986	486 576	19	
		05.04-11.08	66	PR-Code OEJ			0986	486 576	19	
	1.9 TDI 4Motion	10.03-02.06	77	PR-Code OEJ			0986	486 576	19	
		08.05-10.08	77				0986	486 595	29	
	2.0 FSI	01.04-11.08	110	PR-Code OEJ			0986	486 576	19	
		01.05-11.05	110	PR-Code OEM			0986	486 554	19,05	
		11.05-11.08	110				0986	486 576	19	
	2.0 GTI, TDI	09.04-11.08	125/147/169				0986	486 595	29	
	2.0 SDI	01.04-11.08	55	PR-Code OEM			0986	486 554	19,05	
	2.0 TDI, TDI 4Motion	10.03-11.08	100/103				0986	486 595	29	
	2.5	05.07-11.08	125				0986	486 576	19	
	3.2 R32, R32 4Motion	05.05-11.08	184				0986	486 595	29	

		S							
Golf VI Cabriolet [517]									
									
	1.2 TSI	03.11-11.13	77	PR-Code 1ZP, PR-Code 1ZD	JBH, LLE		0 986 480 870	22	
	1.4 TSI	03.11→	90/118	PR-Code 1ZP, PR-Code 1ZD	JBH, LLE		0 986 480 870	22	
	1.6 TDI	03.11-11.13	77	PR-Code 1ZP, PR-Code 1ZD	JBH, LLE		0 986 480 870	22	
	2.0 TDI, TSI	11.11-11.13	103/155	PR-Code 1ZP, PR-Code 1ZD	JBH, LLE		0 986 480 870	22	
	1.2 TSI	03.11-11.13	77				0 986 486 554	19,05	
	1.4 TSI	03.11→	118				0 986 486 576	19	
		11.11-11.13	90				0 986 486 554	19,05	
	1.6 TDI	03.11-11.13	77				0 986 486 576	19	
Golf VI Variant [AJ5]									
									
	1.2 TSI	08.09-04.13	63/77		JBH, LLE ATE		0 986 480 870	22	
	1.4, TSI	06.09-04.13	59/90/118		JBH, LLE ATE		0 986 480 870	22	
	1.6, Multifuel, MultiFuel, TDI, TDI 4Motion	07.09-04.13	66/75/77		JBH, LLE ATE		0 986 480 870	22	
	2.0 TDI	07.09-04.13	81/100/103		JBH, LLE ATE		0 986 480 870	22	
	2.0 TSI	07.09-04.13	147	PR-Code 1ZD	JBH, LLE ATE		0 986 480 870	22	
	1.2 TSI	08.09-04.13	63/77				0 986 486 554	19,05	
	1.4, TSI	06.09-04.13	59/90				0 986 486 554	19,05	
	1.4 TSI	07.09-04.13	118				0 986 486 576	19	
	1.6, Multifuel, MultiFuel	07.09-04.13	75				0 986 486 554	19,05	
	1.6 TDI	12.09-04.13	66				0 986 486 595	29	
	1.6 TDI, TDI 4Motion	07.09-04.13	77				0 986 486 595	29	
	2.0 TDI	07.09-04.13	100				0 986 486 595	29	
			103				0 986 486 554	19,05	
		01.10-04.13	81				0 986 486 554	19,05	
	2.0 TSI	07.09-04.13	147				0 986 486 554	19,05	
Golf VI [5K1]									
									
	1.2 TSI	05.09-04.11	63/77	PR-Code 1ZF, PR-Code 1ZP, PR-Code 1ZD		BO	F 026 003 715	22,2	
				PR-Code 1ZF, PR-Code 1ZP, PR-Code 1ZD, PR-Code 1LV	JBH, LLE ATE		0 986 480 870	22	
		05.11-11.12	63/77	PR-Code 1ZF, PR-Code 1ZP, PR-Code 1ZD, PR-Code 1LV	JBH, LLE		0 986 480 870	22	
		OFD 05.11-11.12	63/77	PR-Code 1ZE	JBH, LLE		0 986 480 870	22	
	1.4	10.08-04.11	59/90/118	PR-Code 1ZF, PR-Code 1ZP, PR-Code 1ZD, PR-Code 1LV	JBH, LLE ATE		0 986 480 870	22	
		05.11-11.12	59/90/118	PR-Code 1ZF, PR-Code 1ZP, PR-Code 1ZD, PR-Code 1LV	JBH, LLE		0 986 480 870	22	
		OFD 05.11-11.12	59/90/118	PR-Code 1ZE	JBH, LLE		0 986 480 870	22	
	1.4	10.08-04.11	59/90/118	PR-Code 1ZF, PR-Code 1ZP, PR-Code 1ZD		BO	F 026 003 715	22,2	
	1.4 TSI	10.08-04.11	59/90/118	PR-Code 1ZF, PR-Code 1ZP, PR-Code 1ZD, PR-Code 1LV	JBH, LLE ATE		0 986 480 870	22	
		05.11-11.12	59/90/118	PR-Code 1ZF, PR-Code 1ZP, PR-Code 1ZD, PR-Code 1LV	JBH, LLE		0 986 480 870	22	
		OFD 05.11-11.12	59/90/118	PR-Code 1ZE	JBH, LLE		0 986 480 870	22	
	1.6	10.08-04.11	75	PR-Code 1ZF, PR-Code 1ZP, PR-Code 1ZD		BO	F 026 003 715	22,2	
	1.6, BiFuel, MultiFuel, TDI, TDI 4Motion	OFD 05.11-11.12	66/72-75/77	PR-Code 1ZE	JBH, LLE		0 986 480 870	22	

















		S							
◀ VW Golf VI [5K1]									
1.6		10.08-04.11	75	PR-Code 1ZF, PR-Code 1ZP, PR-Code 1ZD, PR-Code 1LV	JBH, LLE	ATE	0986 480 870	22	
1.6 MultiFuel		05.11-11.12	75	PR-Code 1ZF, PR-Code 1ZP, PR-Code 1ZD, PR-Code 1LV	JBH, LLE		0986 480 870	22	
1.6 BiFuel		11.08-04.11	66/72-75	PR-Code 1ZF, PR-Code 1ZP, PR-Code 1ZD		BO	F 026 003 715	22,2	
1.6 TDI		05.11-11.12	66/72-75	PR-Code 1ZF, PR-Code 1ZP, PR-Code 1ZD, PR-Code 1LV	JBH, LLE	ATE	0986 480 870	22	
1.6 MultiFuel		10.08-05.10	75			BO	F 026 003 715	22,2	
		05.10-04.11	75	PR-Code 1ZF, PR-Code 1ZP, PR-Code 1ZD		BO	F 026 003 715	22,2	
1.6 TDI		12.08-04.11	77	PR-Code 1ZF, PR-Code 1ZP, PR-Code 1ZD		BO	F 026 003 715	22,2	
1.6 TDI 4Motion		05.11-11.12	77	PR-Code 1ZF, PR-Code 1ZP, PR-Code 1ZD, PR-Code 1LV	JBH, LLE	ATE	0986 480 870	22	
		05.11-11.12	77	PR-Code 1ZF, PR-Code 1ZP, PR-Code 1ZD, PR-Code 1LV	JBH, LLE		0986 480 870	22	
1.8 TSI		06.09-01.11	118	PR-Code 1ZF, PR-Code 1ZP, PR-Code 1ZD, PR-Code 1LV	JBH, LLE	ATE	0986 480 870	22	
						BO	F 026 003 715	22,2	
2.0 GTI		04.09-04.11	155	PR-Code 1ZF, PR-Code 1ZP, PR-Code 1ZD		BO	F 026 003 715	22,2	
				PR-Code 1ZF, PR-Code 1ZP, PR-Code 1ZD, PR-Code 1LV	JBH, LLE	ATE	0986 480 870	22	
		05.11-11.12	155	PR-Code 1ZF, PR-Code 1ZP, PR-Code 1ZD, PR-Code 1LV	JBH, LLE		0986 480 870	22	
			173	PR-Code 1ZF, PR-Code 1ZP, PR-Code 1ZD, PR-Code 1LV	JBH, LLE		0986 480 870	22	
2.0 GTI, TDI, TDI 4Motion, TSI 4Motion	OFD	05.11-11.12	81/100/103/125/155/173/188/199	PR-Code 1ZE	JBH, LLE		0986 480 870	22	
2.0 TDI		10.08-05.11	81	PR-Code 1ZF, PR-Code 1ZP, PR-Code 1ZD, PR-Code 1LV	JBH, LLE	ATE	0986 480 870	22	
		05.11-11.12	81	PR-Code 1ZF, PR-Code 1ZP, PR-Code 1ZD, PR-Code 1LV	JBH, LLE		0986 480 870	22	
2.0 TDI, TDI 4Motion		10.08-05.10	100/103/125			BO	F 026 003 715	22,2	
		10.08-04.11	100/103/125	PR-Code 1ZF, PR-Code 1ZP, PR-Code 1ZD, PR-Code 1LV	JBH, LLE	ATE	0986 480 870	22	
		09.09-04.11	100/103/125	PR-Code 1ZF, PR-Code 1ZP, PR-Code 1ZD		BO	F 026 003 715	22,2	
		05.11-11.12	100/103/125	PR-Code 1ZF, PR-Code 1ZP, PR-Code 1ZD, PR-Code 1LV	JBH, LLE		0986 480 870	22	
2.0 TSI 4Motion		11.09-04.11	188	PR-Code 1ZF, PR-Code 1ZP, PR-Code 1ZD		BO	F 026 003 715	22,2	
				PR-Code 1ZF, PR-Code 1ZP, PR-Code 1ZD, PR-Code 1LV	JBH, LLE	ATE	0986 480 870	22	
			199	PR-Code 1ZF, PR-Code 1ZP, PR-Code 1ZD		BO	F 026 003 715	22,2	
				PR-Code 1ZF, PR-Code 1ZP, PR-Code 1ZD, PR-Code 1LV	JBH, LLE	ATE	0986 480 870	22	
		11.09-05.11	195			BO	F 026 003 715	22,2	
				PR-Code 1ZF, PR-Code 1ZP, PR-Code 1ZD, PR-Code 1LV	JBH, LLE	ATE	0986 480 870	22	
		05.11-11.12	188	PR-Code 1ZF, PR-Code 1ZP, PR-Code 1ZD, PR-Code 1LV	JBH, LLE		0986 480 870	22	
			199	PR-Code 1ZF, PR-Code 1ZP, PR-Code 1ZD, PR-Code 1LV	JBH, LLE		0986 480 870	22	



		S							
	1.2 TSI	05.09-11.12	63/77				LLE,TW	0 204 055 051	
	1.4, TSI	10.08-11.12	59/90/118				LLE,TW	0 204 055 051	
	1.6	10.08-02.12	75	PR-Code 1ZD, PR-Code 1ZE, PR-Code 1ZF, PR-Code 1ZP			LLE BO	0 204 055 051	
		10.08-11.12	75				LLE,TW	0 204 055 051	
	1.6 BiFuel, TDI	11.08-11.12	66/72-75				LLE,TW	0 204 055 051	
	1.6 MultiFuel	10.08-11.12	75				LLE,TW	0 204 055 051	
	1.6 TDI, TDI 4Motion	12.08-11.12	77				LLE,TW	0 204 055 051	
	1.8 TSI	06.09-01.11	118				LLE,TW	0 204 055 051	
	2.0 GTI	04.09-02.12	155	PR-Code 1ZD, PR-Code 1ZE, PR-Code 1ZF, PR-Code 1ZP			LLE BO	0 204 055 051	
	2.0 GTI, TSI 4Motion, 4Motion	11.09→	173/188/191/195/199				LLE,TW	0 204 055 051	
2.0 TDI, TDI 4Motion	10.08-11.12	81/100/103/125				LLE,TW	0 204 055 051		
	1.2 TSI	05.09-11.12	63/77					0 986 486 554	19,05
	1.4	10.08-11.12	59					0 986 486 554	19,05
	1.4 TSI	10.08-11.12	90/118					0 986 486 576	19
	1.6	10.08-11.12	75					0 986 486 554	19,05
	1.6 BiFuel	11.08-11.12	72-75					0 986 486 554	19,05
	1.6 MultiFuel	10.08-05.10	75	PR-Code OEM				0 986 486 554	19,05
		05.10-11.12	75					0 986 486 554	19,05
	1.6 TDI	02.09-11.12	66					0 986 486 576	19
	1.6 TDI, TDI 4Motion	12.08-11.12	77					0 986 486 576	19
	1.8 TSI	06.09-01.11	118	PR-Code OEJ				0 986 486 576	19
				PR-Code OEM				0 986 486 554	19,05
	2.0 GTI, TSI 4Motion	04.09-11.12	155/173/188					0 986 486 595	29
	2.0 TDI	10.08-05.11	81	PR-Code OEJ				0 986 486 576	19
				PR-Code OEM				0 986 486 554	19,05
		05.10-11.12	81					0 986 486 576	19
2.0 TDI, TDI 4Motion	10.08-04.11	100/103/125					0 986 486 595	29	
2.0 TSI 4Motion	11.09-05.11	195	PR-Code OEJ				0 986 486 576	19	
			PR-Code OEM				0 986 486 554	19,05	
	11.09-11.12	199					0 986 486 595	29	
Golf VII Variant [BA5]									
									
	1.2 TSI, TSI MultiFuel	05.13→	63/77/81					0 986 486 554	19,05
	1.4 TGI, TSI	05.13→	81/90/92					0 986 486 554	19,05
	1.6	05.14→	81					0 986 486 554	19,05
Golf VII [5G1]									
									
	1.4 GTE	05.14→	110-150				LLE RLE	0 204 819 790 0 204 819 792	
	1.2 TSI	08.12→	63/77/81					0 986 486 554	19,05
	1.4 TGI	06.13→	81					0 986 486 554	19,05
	1.4 TSI	11.12→	90					0 986 486 554	19,05
	1.4 TSI MultiFuel	11.12-01.13	90					0 986 486 576	19
	1.4 TSI, TSI ACT	08.12-01.13	103					0 986 486 576	19
	1.4 TSI, TSI MultiFuel	05.14→	92					0 986 486 554	19,05
	1.6 TDI	08.12-01.13	77/81					0 986 486 576	19
	2.0 TDI	11.12-01.13	81					0 986 486 576	19
Jetta									
									
	1.6 CEX, GEX	10.98-01.04	53				JBH	F 026 003 562	20,6
	1.6 i CI, GI, CIX, GIX	01.99-07.08	64				JBH	F 026 003 563	22

		S							
◀ VW									
Jetta [AV2]									
	1.4 TSI	03.13→	90/110					0986 486 554	19,05
	1.6	03.13→	63/77					0986 486 554	19,05
Jetta [AV3]									
	1.4 TSI	10.14→	90					0986 486 554	19,05
	1.6	10.14→	63/77					0986 486 554	19,05
Jetta III [1H8]									
	1.6, i	ABO 11.92-12.99	60/74		RLE			0986 485 111	
	1.8 i	ABO 11.96-12.99	82		RLE			0986 485 111	
	2.0 i	ABO 11.96-12.99	85		RLE			0986 485 111	
Jetta IV [1J2]									
	1.6 i	09.99-12.05	74		TW			0 204 123 406	23,81
	1.9 TDI	09.99-12.05	81		RLE			0 204 123 406	23,81
	2.0 i	09.99-12.05	85		RLE			0 204 123 406	23,81
	2.3 i	09.99-12.05	110/125		RLE			0 204 123 406	23,81
	1.6 i	09.99-12.05	74					0 204 125 505	
	1.8 T	OFD 09.03-12.05	110/132		RLE			0 204 125 505	
	1.9 TDI	OFD 09.99-12.05	81		RLE			0 204 125 505	
	2.0 i	OFD 09.99-12.05	85		RLE			0 204 125 505	
	2.3 i	07.01-12.05	125		TW			0 204 125 505	
		OFD 09.99-08.01	110		RLE			0 204 125 505	
	1.6 i	09.99-12.05	74		TW			0986 486 047	15,87
								0986 486 060	15,87
	1.6 i	09.99-12.05	74		FSG			0986 486 542	23,81
					FSZ			0986 486 538	19
Jetta V [1K6]									
	2.0 TDI	03.06→	103		BO			F 026 003 715	22,2
Jetta [1H2/1W2]									
	1.9 TDI	ABO 08.95→	66		JBH			F 026 003 563	22
	2.0	ABO 08.92-09.98	85		JBH			F 026 003 563	22
Jetta [1K2]									
	1.4 TSI	07.06-06.08	125	PR-Code 1ZF, PR-Code 1ZP, PR-Code 1ZD, PR-Code 1LV	JBH, LLE	ATE		0986 480 870	22
		07.06-10.10	90/103		JBH, LLE	ATE		0986 480 870	22
		07.08-10.10	118	PR-Code 1LJ, PR-Code 1LL, PR-Code 1ZA, PR-Code 1ZB	JBH, LLE	ATE		0986 480 870	22
	1.6, FSI, MultiFuel, TDI	09.05-10.10	66/75/77/85		JBH, LLE	ATE		0986 480 870	22



		S							
1.9 TDI		09.05-10.10	77			JBH, LLE ATE	0 986 480 870	22	
2.0 FSI, TDI		08.05-10.10	81/100/103/110			JBH, LLE ATE	0 986 480 870	22	
2.0 TDI, TSI		06.05-10.10	125/147			JBH, LLE ATE	0 986 480 870	22	
2.5		01.05-10.10	110/125			JBH, LLE ATE	0 986 480 870	22	
 1.4 TSI		07.06-06.08	103	PR-Code OEM			0 986 486 554	19,05	
			125	PR-Code OEM			0 986 486 554	19,05	
		07.07-10.10	90				0 986 486 554	19,05	
		07.08-10.10	118	PR-Code OEJ			0 986 486 576	19	
				PR-Code OEM			0 986 486 554	19,05	
1.6, MultiFuel		10.05-10.10	75				0 986 486 554	19,05	
1.6 FSI		09.05-06.08	85	PR-Code OEM			0 986 486 554	19,05	
1.6 TDI		07.09-10.10	77	PR-Code OEJ			0 986 486 576	19	
				PR-Code OEM			0 986 486 554	19,05	
		12.09-10.10	66	PR-Code OEJ			0 986 486 576	19	
				PR-Code OEM			0 986 486 554	19,05	
1.9 TDI		09.05-02.06	77				0 986 486 576	19	
		09.05-10.10	77	PR-Code OEJ			0 986 486 576	19	
				PR-Code OEM			0 986 486 554	19,05	
2.0 FSI		08.05-06.08	110	PR-Code OEM			0 986 486 554	19,05	
2.0 TDI		08.05-10.10	100/103				0 986 486 595	29	
		01.10-10.10	81				0 986 486 554	19,05	
2.0 TDI, TSI		09.05-10.10	125/147				0 986 486 595	29	
2.5		07.07-10.10	125				0 986 486 576	19	
				PR-Code OEM			0 986 486 554	19,05	
Jetta [9M2]									
									
 1.8		OFD 09.98→	110				F 026 003 339	23,81	
		06.00-08.08	132		TW		F 026 003 339	23,81	
2.0		OFD 12.98-06.04	85				F 026 003 339	23,81	
2.8		OFD 10.98-12.04	130/147				F 026 003 339	23,81	
 1.8		ABO 06.00-08.08	132			BO	0 204 125 717		
 1.8		09.98→	110/132				0 986 486 031	15,87	
2.0		12.98-06.04	85				0 986 486 031	15,87	
2.8		10.98-12.04	130/147				0 986 486 031	15,87	
 1.8		09.98→	110				0 986 486 538	19	
		06.00-08.08	132		MG5		0 986 486 538	19	
					MG6		0 986 486 595	29	
2.0		12.98-06.04	85				0 986 486 538	19	
2.8		10.98-12.04	130				0 986 486 538	19	
		10.01-06.04	147				0 986 486 538	19	
							0 986 486 595	29	
Jetta [162]									
									
 1.2 TSI		10.10-07.14	77				0 986 486 554	19,05	
1.4 TSI		04.11-10.11	110/118				0 986 486 576	19	
		07.11-07.14	90				0 986 486 554	19,05	
1.6		12.11-07.14	77				0 986 486 554	19,05	
1.6 TDI		10.10-07.12	77				0 986 486 576	19	
2.0 TDI		10.10-04.13	103				0 986 486 595	29	
2.0 TSI		10.10-07.14	147/155				0 986 486 595	29	





◀ VW

Jetta [163]



	1.2 TSI	07.14→	77/81			0986 486 554	19,05
	1.4 TSI	08.14→	90/92			0986 486 554	19,05
	2.0 TSI	10.14→	155			0986 486 595	29

Kombi



	2.5 i	ABO	07.93-05.95	82-85	Fg.-Nr. →70..S..127 805	JBH	F 026 003 563	22
			07.93-05.05	82-85		254,JBH	0986 481 030	25,4
			06.95-05.05	82-85	Fg.-Nr. 70..S..127 806→	JBH	0986 480 930	23,81
	ABS	07.93-05.95	82-85	Fg.-Nr. →70..S..127 805	JBH	0986 480 834	22,2	
		07.93-05.05	82-85		254,JBH	0986 481 007	25,4	
		06.95-05.05	82-85	Fg.-Nr. 70..S..127 806→	JBH	0986 480 933	23,81	
	2.5 i		07.93-05.05	82-85		TW	0986 486 037	19,05
							0986 486 048	15,87
	2.5 i		07.93-05.05	82-85		TW	0986 486 537	23,8
							0986 486 538	19
							0986 486 576	19
	2.5 i		07.93-05.05	82-85			0986 482 036^A	
	2.5 i		10.97-05.05	82-85	Fg.-Nr. 70..W..062 420→		0 265 220 434^F	

LT [2D, 2H]



	28 2.3	ABO	05.96-08.01	96/105	Fg.-Nr. →2D..2H011 024		0 204 123 483	23,81
	28 2.8 D Turbo	ABS	05.96-08.01	96/105	Fg.-Nr. →2D..2H011 024	JBH	F 026 003 484	23,81
	28 2.5 SDI	ABO	05.96-04.01	55			0 204 123 483	23,81
		ABS	05.96-04.01	55		JBH	F 026 003 484	23,81
	28 2.5 TDI	ABO	05.96-05.99	75			0 204 123 483	23,81
			05.99-04.01	66			0 204 123 483	23,81
			05.99-08.01	80	Fg.-Nr. →2D..2H011 024		0 204 123 483	23,81
			04.01-08.01	61/70	Fg.-Nr. →2D..2H011 024		0 204 123 483	23,81
		ABS	05.96-05.99	75		JBH	F 026 003 484	23,81
			05.99-04.01	66		JBH	F 026 003 484	23,81
			05.99-08.01	80	Fg.-Nr. →2D..2H011 024	JBH	F 026 003 484	23,81
			04.01-08.01	61/70	Fg.-Nr. →2D..2H011 024	JBH	F 026 003 484	23,81
	28 2.8 D Turbo	ABO	07.97-12.98	92			0 204 123 483	23,81
		ABS	07.97-12.98	92		JBH	F 026 003 484	23,81
	35 2.3	ABO	05.96-08.01	96/105	Fg.-Nr. →2D..2H011 024		0 204 123 483	23,81
	35 2.8 D Turbo	ABS	05.96-08.01	96/105	Fg.-Nr. →2D..2H011 024	JBH	F 026 003 484	23,81
	35 2.5 SDI	ABO	05.96-04.01	55			0 204 123 483	23,81
		ABS	05.96-04.01	55		JBH	F 026 003 484	23,81
	35 2.5 TDI	ABO	05.96-05.99	75			0 204 123 483	23,81
			05.99-04.01	66			0 204 123 483	23,81
			05.99-08.01	80	Fg.-Nr. →2D..2H011 024		0 204 123 483	23,81
			04.01-08.01	61/70	Fg.-Nr. →2D..2H011 024		0 204 123 483	23,81
		ABS	05.96-05.99	75		JBH	F 026 003 484	23,81
			05.99-04.01	66		JBH	F 026 003 484	23,81
			05.99-08.01	80	Fg.-Nr. →2D..2H011 024	JBH	F 026 003 484	23,81
			04.01-08.01	61/70	Fg.-Nr. →2D..2H011 024	JBH	F 026 003 484	23,81
	35 2.8 D Turbo	ABO	07.97-12.98	92			0 204 123 483	23,81
		ABS	07.97-12.98	92		JBH	F 026 003 484	23,81

		S								
46 2.3	ABO	05.96-08.01	96/105	Fg.-Nr. →2D..2H011 024			0 204 123 483	23,81		
46 2.8 D Turbo	ABS	05.96-08.01	96/105	Fg.-Nr. →2D..2H011 024		JBH	F 026 003 484	23,81		
						254	0 204 123 370	25,4		
46 2.5 SDI	ABO	05.96-04.01	55				0 204 123 483	23,81		
	ABS	05.96-04.01	55			JBH	F 026 003 484	23,81		
46 2.5 TDI	ABO	05.96-05.99	75				0 204 123 483	23,81		
		05.96-08.01	80	Fg.-Nr. →2D..2H011 024			0 204 123 483	23,81		
		05.99-04.01	66				0 204 123 483	23,81		
		04.01-08.01	61	Fg.-Nr. →2D..2H011 024			0 204 123 483	23,81		
	ABS	05.96-08.98	80	Fg.-Nr. →2D..X..012 291		JBH	F 026 003 484	23,81		
		05.96-05.99	75			JBH	F 026 003 484	23,81		
						254	0 204 123 370	25,4		
		09.98-08.01	80	Fg.-Nr. 2D..X..012 292→ 2D..2H011 024			0 204 123 370	25,4		
	ABS	05.99-04.01	66			JBH	F 026 003 484	23,81		
						254	0 204 123 370	25,4		
		05.99-08.01	80	Fg.-Nr. →2D..2H011 024		JBH	F 026 003 484	23,81		
						254	0 204 123 370	25,4		
		04.01-08.01	61	Fg.-Nr. →2D..2H011 024		JBH	F 026 003 484	23,81		
						254	0 204 123 370	25,4		
			70	Fg.-Nr. →2D..2H011 024		JBH	F 026 003 484	23,81		
						254	0 204 123 370	25,4		
46 2.8 D Turbo	ABO	07.97-12.98	92				0 204 123 483	23,81		
	ABS	07.97-12.98	92			JBH	F 026 003 484	23,81		
						254	0 204 123 370	25,4		
	28 2.3, 2.8 D Turbo	05.96-08.01	96/105	Fg.-Nr. →2D..2H011 024			0 204 125 741			
		28 2.5 SDI	05.96-04.01	55				0 204 125 741		
	28 2.5 TDI	05.96-05.99	75					0 204 125 741		
		05.99-04.01	66					0 204 125 741		
		05.99-08.01	80	Fg.-Nr. →2D..2H011 024				0 204 125 741		
		04.01-08.01	61	Fg.-Nr. →2D..2H011 024				0 204 125 741		
	28 2.8 D Turbo		07.97-12.98	92				0 204 125 741		
								0 204 125 741		
	35 2.3, 2.8 D Turbo		05.96-08.01	96/105	Fg.-Nr. →2D..2H011 024			0 204 125 741		
	35 2.5 SDI		05.96-04.01	55				0 204 125 741		
	35 2.5 TDI		05.96-05.99	75				0 204 125 741		
			05.99-04.01	66				0 204 125 741		
			05.99-08.01	80	Fg.-Nr. →2D..2H011 024				0 204 125 741	
			04.01-08.01	61	Fg.-Nr. →2D..2H011 024				0 204 125 741	
	35 2.8 D Turbo		07.97-12.98	92				0 204 125 741		
								0 204 125 741		
46 2.3, 2.8 D Turbo		05.96-08.01	96/105	Fg.-Nr. →2D..2H011 024			0 204 125 741			
46 2.5 SDI		05.96-04.01	55				0 204 125 741			
46 2.5 TDI		05.96-05.99	75				0 204 125 741			
		05.96-08.01	80	Fg.-Nr. →2D..2H011 024			0 204 125 741			
		05.99-04.01	66				0 204 125 741			
		04.01-08.01	61	Fg.-Nr. →2D..2H011 024				0 204 125 741		
46 2.8 D Turbo		07.97-12.98	92				0 204 125 741			
							0 204 125 741			
	28 2.3, 2.5 SDI, 2.5 TDI, 2.8 D Turbo, 2.8 TDI	05.96-04.06	55/61/66/70/75/80/92/ 96/105/116				0 986 486 053	19,05		
	35 2.3, 2.5 SDI, 2.5 TDI, 2.8 D Turbo, 2.8 TDI	05.96-04.06	55/61/66/70/75/80/92/ 96/105/116				0 986 486 053	19,05		
	46 2.3, 2.5 SDI, 2.5 TDI, 2.8 D Turbo, 2.8 TDI	05.96-04.06	55/61/66/70/75/80/92/ 96/105/116				0 986 486 053	19,05		
	28 2.3, 2.5 SDI, 2.5 TDI	05.96-04.06	55/61/66/70/75/80/105				0 986 486 546	22,2		
	35 2.3, 2.5 SDI, 2.5 TDI	05.96-04.06	55/61/66/70/75/80/105				0 986 486 546	22,2		
	46 2.3, 2.5 SDI, 2.5 TDI	05.96-04.06	55/61/66/70/75/80/105				0 986 486 546	22,2		





◀ VW LT [2D, 2H]

	28 2.3, 2.5 SDI, 2.5 TDI, 2.8 D Turbo, 2.8 TDI		05.96-04.06	55/61/66/70/75/80/92/96/105/116			0 204 131 248 ^A	
	35 2.3	ABO	05.96-11.98	105	Fg.-Nr. →2D..X..021 000		0 204 131 248 ^A	
			12.98-11.01	105	Fg.-Nr. 2D..X..021 001→	R30,R35 R40	0 204 131 249 ^A 0 204 131 250 ^A	
	35 2.3, 2.5 SDI, 2.5 TDI, 2.8 D Turbo, 2.8 TDI	ABS	05.96-04.06	55/61/66/70/75/80/92/96/105/116			0 204 131 248 ^A	
	35 2.5 SDI	ABO	05.96-11.98	55	Fg.-Nr. →2D..X..021 000		0 204 131 248 ^A	
			12.98-04.01	55	Fg.-Nr. 2D..X..021 001→	R30,R35 R40	0 204 131 249 ^A 0 204 131 250 ^A	
	35 2.5 TDI	ABO	05.96-11.98	75	Fg.-Nr. →2D..X..021 000		0 204 131 248 ^A	
			12.98-05.99	75	Fg.-Nr. 2D..X..021 001→	R30,R35 R40	0 204 131 249 ^A 0 204 131 250 ^A	
			05.99-04.06	61/66/70		R30,R35 R40	0 204 131 249 ^A 0 204 131 250 ^A	
				80		R30,R35 R40	0 204 131 249 ^A 0 204 131 250 ^A	
	35 2.8 D Turbo	ABO	07.97-11.98	92	Fg.-Nr. →2D..X..021 000		0 204 131 248 ^A	
			12.98-12.98	92	Fg.-Nr. 2D..X..021 001→	R30,R35 R40	0 204 131 249 ^A 0 204 131 250 ^A	
			01.99-01.02	96		R30,R35 R40	0 204 131 249 ^A 0 204 131 250 ^A	
	35 2.8 TDI	ABO	02.02-04.06	116		R30,R35 R40	0 204 131 249 ^A 0 204 131 250 ^A	
	46 2.3, 2.5 SDI, 2.5 TDI, 2.8 D Turbo, 2.8 TDI	ABO	05.96-04.06	55/61/66/70/75/80/92/96/105/116			0 204 131 251 ^A	
		ABS	05.96-04.06	55/61/66/70/75/80/92/96/105/116			0 204 131 248 ^A	
	28 2.3		06.98-11.01	105	Fg.-Nr. 2D..X..000 053→		0 265 220 489 ^E	
	28 2.5 SDI		06.98-04.01	55	Fg.-Nr. 2D..X..000 053→		0 265 220 489 ^E	
	28 2.5 TDI		06.98-05.99	75	Fg.-Nr. 2D..X..000 053→		0 265 220 489 ^E	
			05.99-04.06	61/66/70			0 265 220 489 ^E	
				80			0 265 220 489 ^E	
	28 2.8 D Turbo		06.98-12.98	92	Fg.-Nr. 2D..X..000 053→		0 265 220 489 ^E	
			01.99-01.02	96			0 265 220 489 ^E	
	28 2.8 TDI		02.02-04.06	116			0 265 220 489 ^E	
	35 2.3		06.98-11.01	105	Fg.-Nr. 2D..X..000 053→		0 265 220 489 ^E	
	35 2.5 SDI		06.98-04.01	55	Fg.-Nr. 2D..X..000 053→		0 265 220 489 ^E	
	35 2.5 TDI		06.98-05.99	75	Fg.-Nr. 2D..X..000 053→		0 265 220 489 ^E	
			05.99-04.06	61/66/70			0 265 220 489 ^E	
				80			0 265 220 489 ^E	
	35 2.8 D Turbo		06.98-12.98	92	Fg.-Nr. 2D..X..000 053→		0 265 220 489 ^E	
			01.99-01.02	96			0 265 220 489 ^E	
	35 2.8 TDI		02.02-04.06	116			0 265 220 489 ^E	
	46 2.3		06.98-11.01	105	Fg.-Nr. 2D..X..000 053→		0 265 220 489 ^E	
	46 2.5 SDI		06.98-04.01	55	Fg.-Nr. 2D..X..000 053→		0 265 220 489 ^E	
	46 2.5 TDI		06.98-05.99	75	Fg.-Nr. 2D..X..000 053→		0 265 220 489 ^E	
			06.98-04.06	80	Fg.-Nr. 2D..X..000 053→		0 265 220 489 ^E	
			05.99-04.06	61/66/70			0 265 220 489 ^E	
				80			0 265 220 489 ^E	
	46 2.8 D Turbo		06.98-12.98	92	Fg.-Nr. 2D..X..000 053→		0 265 220 489 ^E	
			01.99-01.02	96			0 265 220 489 ^E	
	46 2.8 TDI		02.02-04.06	116			0 265 220 489 ^E	

LT [28, 29, 21]

	28 2.4, 2.4 D, 2.4 D Turbo		10.88-04.96	51/70				1 987 472 178
						JBH	0 986 480 079	23,81
	31 2.4, 2.4 D, 2.4 D Turbo		10.88-04.96	51/70				1 987 472 178
						JBH	0 986 480 079	23,81
	35 2.4, 2.4 D, 2.4 D Turbo		10.88-04.96	51/70				1 987 472 178
						JBH	0 986 480 079	23,81

		S							
	40 2.4, 2.4 D, 2.4 D Turbo	10.88-04.96	51/70						1 987 472 178
						JBH	0 986 480 079	23,81	
	45 2.4 D	08.92-04.96	51/70						1 987 472 178
	45 2.4 D Turbo					JBH	0 986 480 079	23,81	
	50 2.4 D	08.92-04.96	51/70						1 987 472 178
	50 2.4 D Turbo					JBH	0 986 480 079	23,81	
	55 2.4 D	08.92-04.96	51/70						1 987 472 178
	55 2.4 D Turbo					JBH	0 986 480 079	23,81	
	28 2.4, 2.4 D, 2.4 D Turbo	08.89-04.96	51/70				0 265 103 059 ^H		
						FLR	0 265 100 069 ^H		
	31 2.4, 2.4 D, 2.4 D Turbo	08.89-04.96	51/70				0 265 103 059 ^H		
						FLR	0 265 100 069 ^H		
	35 2.4, 2.4 D, 2.4 D Turbo	08.89-04.96	51/70				0 265 103 059 ^H		
						FLR	0 265 100 069 ^H		
	40 2.4, 2.4 D, 2.4 D Turbo	08.89-04.96	51/70				0 265 103 059 ^H		
						FLR	0 265 100 069 ^H		
	45 2.4 D	08.92-04.96	51/70				0 265 103 059 ^H		
	45 2.4 D Turbo					FLR	0 265 100 069 ^H		
	50 2.4 D	08.92-04.96	51/70				0 265 103 059 ^H		
	50 2.4 D Turbo					FLR	0 265 100 069 ^H		
	55 2.4 D	08.92-04.96	51/70				0 265 103 059 ^H		
	55 2.4 D Turbo					FLR	0 265 100 069 ^H		

Lupo [6X1]

	1.0	10.98-07.05	37			JBH,RLE	0 986 480 869	22	
		ABO 10.98-07.05	37			JBH,LLE	F 026 003 562	20,6	
		ABS, 10.98-07.05	37			JBH,LLE	0 986 481 013	22,2	
		OFD					0 986 481 015	23,81	
	1.2 TDI 3L	10.98-07.05	45			JBH,RLE	0 986 480 869	22	
		ABO 10.98-07.05	45			JBH,LLE	F 026 003 562	20,6	
		ABS, 10.98-07.05	45			JBH,LLE	0 986 481 013	22,2	
		OFD					0 986 481 015	23,81	
	1.4	06.98-07.05	44/55/74/77			JBH,RLE	0 986 480 869	22	
	1.4 FSI	ABO 06.98-07.05	44/55/74/77			JBH,LLE	F 026 003 562	20,6	
	1.4 TDI	ABS, 06.98-07.05	44/55/74/			JBH,LLE	0 986 481 013	22,2	
		OFD	77				0 986 481 015	23,81	
	1.6 GTI	05.00-07.05	92			JBH,RLE	0 986 480 869	22	
		ABO 05.00-07.05	92			JBH,LLE	F 026 003 562	20,6	
		ABS, 05.00-07.05	92			JBH,LLE	0 986 481 013	22,2	
		OFD					0 986 481 015	23,81	
	1.7 SDI	10.98-07.05	44			JBH,RLE	0 986 480 869	22	
		ABO 10.98-07.05	44			JBH,LLE	F 026 003 562	20,6	
		ABS, 10.98-07.05	44			JBH,LLE	0 986 481 013	22,2	
		OFD					0 986 481 015	23,81	
	1.0	10.98-07.05	37			RLE	0 204 125 516		
		ABO 10.98-07.05	37			LLE	0 204 125 254		
	1.2 TDI 3L	10.98-07.05	45			RLE	0 204 125 516		
		ABO 10.98-07.05	45			LLE	0 204 125 254		
	1.4, FSI, TDI	06.98-07.05	44/55/74/77			RLE	0 204 125 516		
		ABO 06.98-07.05	44/55/74/77			LLE	0 204 125 254		
	1.6 GTI	05.00-07.05	92			RLE	0 204 125 516		
		ABO 05.00-07.05	92			LLE	0 204 125 254		
	1.7 SDI	10.98-07.05	44			RLE	0 204 125 516		
		ABO 10.98-07.05	44			LLE	0 204 125 254		
	1.4 TDI	06.98-07.05	55				0 986 486 576	19	
	1.6 GTI	05.00-07.05	92				0 986 486 554	19,05	

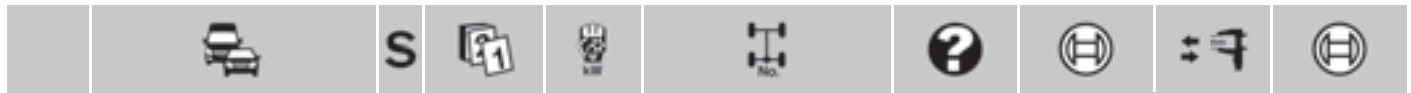

◀ VW Lupo [6X1]











	1.0		10.98-04.99	37			0 986 482 007^A	
	1.2 TDI 3L		10.98-04.99	45			0 986 482 007^A	
	1.4, TDI		06.98-04.99	55/74			0 986 482 007^A	
	1.7 SDI		10.98-04.99	44			0 986 482 007^A	

Multivan T4 [70, 7D]



	1.9 D	ABS, 09.90-04.97	45			254,JBH	0 986 481 007	25,4
		OFD 06.95-04.97	45	Fg.-Nr. 70..S..127 806→		JBH	0 986 480 933	23,81
		MFD 09.90-04.97	45			JBH	0 986 481 007	25,4
	1.9 D Turbo	ABS, 10.92-06.03	50			254,JBH	0 986 481 007	25,4
		OFD 06.95-06.03	50	Fg.-Nr. 70..S..127 806→		JBH	0 986 480 933	23,81
		MFD 10.92-06.03	50			JBH	0 986 481 007	25,4
	1.9 D	ABO 09.90-06.03	45/50			254,JBH	0 986 481 030	25,4
	1.9 D Turbo	06.95-06.03	45/50	Fg.-Nr. 70..S..127 806→		JBH	0 986 480 930	23,81
		ABO, 09.90-05.95	45/50	Fg.-Nr. →70..S..127 805		JBH	F 026 003 563	22
		OFD						
		ABS 09.90-05.95	45/50	Fg.-Nr. →70..S..127 805		JBH	0 986 480 834	22,2
	2.0	ABO 09.90-06.03	62			254,JBH	0 986 481 030	25,4
		06.95-06.03	62	Fg.-Nr. 70..S..127 806→		JBH	0 986 480 930	23,81
		ABO, 09.90-05.95	62	Fg.-Nr. →70..S..127 805		JBH	F 026 003 563	22
		OFD						
		ABS 09.90-05.95	62	Fg.-Nr. →70..S..127 805		JBH	0 986 480 834	22,2
		ABS, 09.90-06.03	62			254,JBH	0 986 481 007	25,4
		OFD 06.95-06.03	62	Fg.-Nr. 70..S..127 806→		JBH	0 986 480 933	23,81
		MFD 09.90-06.03	62			JBH	0 986 481 007	25,4
	2.4 D	ABO 05.97-06.03	55			JBH	0 986 480 930	23,81
						254,JBH	0 986 481 030	25,4
		ABS, 09.90-05.98	57			254,JBH	0 986 481 007	25,4
		OFD 05.97-06.03	55			JBH	0 986 480 933	23,81
						254,JBH	0 986 481 007	25,4
		MFD 09.90-05.98	57			JBH	0 986 481 007	25,4
		05.97-06.03	55			JBH	0 986 481 007	25,4
	2.4 D Syncro	ABS, 11.92-09.98	57			254,JBH	0 986 481 007	25,4
		OFD						
		MFD 11.92-09.98	57			JBH	0 986 481 007	25,4
	2.4 D, D Syncro	ABO 09.90-09.98	57			254,JBH	0 986 481 030	25,4
		06.95-09.98	57	Fg.-Nr. 70..S..127 806→		JBH	0 986 480 930	23,81
		ABO, 09.90-05.95	57	Fg.-Nr. →70..S..127 805		JBH	F 026 003 563	22
		OFD						
		ABS 09.90-05.95	57	Fg.-Nr. →70..S..127 805		JBH	0 986 480 834	22,2
		ABS, 06.95-09.98	57	Fg.-Nr. 70..S..127 806→		JBH	0 986 480 933	23,81
		OFD						
	2.5	ABO 06.95-10.96	81	Fg.-Nr. 70..S..127 806→		JBH	0 986 480 930	23,81
		09.95-12.95	81			JBH	0 986 480 930	23,81
		08.96-06.03	81			JBH	0 986 480 930	23,81
		ABO, 11.90-08.94	81			JBH	F 026 003 563	22
		OFD 07.94-05.95	81	Fg.-Nr. →70..S..127 805		JBH	F 026 003 563	22
		ABS 11.90-08.94	81			JBH	0 986 480 834	22,2
		07.94-05.95	81	Fg.-Nr. →70..S..127 805		JBH	0 986 480 834	22,2
		ABS, 11.90-06.03	81			254,JBH	0 986 481 007	25,4
		OFD 06.95-10.96	81	Fg.-Nr. 70..S..127 806→		JBH	0 986 480 933	23,81
		09.95-12.95	81			JBH	0 986 480 933	23,81
		08.96-06.03	81			JBH	0 986 480 933	23,81
			85			254,JBH	0 986 481 007	25,4
		MFD 11.90-06.03	81			JBH	0 986 481 007	25,4
		08.96-06.03	85			JBH	0 986 481 007	25,4
	2.5	ABO 11.90-06.03	81			254,JBH	0 986 481 030	25,4
	2.5 Syncro	ABS, 08.96-06.03	85			JBH	0 986 480 933	23,81
		OFD						



									
2.5, Syncro, TDI	ABO	08.96-06.03	85/111			JBH	0 986 480 930	23,81	
						254,JBH	0 986 481 030	25,4	
2.5 Syncro	ABO	06.95-10.96	81	Fg.-Nr. 70..S..127 806→		JBH	0 986 480 930	23,81	
		06.97-11.01	81			JBH	0 986 480 930	23,81	
	ABO,	01.94-05.95	81	Fg.-Nr. →70..S..127 805		JBH	F 026 003 563	22	
	OFD								
	ABS	01.94-05.95	81	Fg.-Nr. →70..S..127 805		JBH	0 986 480 834	22,2	
	ABS,	01.94-10.96	81			254,JBH	0 986 481 007	25,4	
	OFD	06.95-10.96	81	Fg.-Nr. 70..S..127 806→		JBH	0 986 480 933	23,81	
		08.96-06.03	85			254,JBH	0 986 481 007	25,4	
		06.97-11.01	81			JBH	0 986 480 933	23,81	
						254,JBH	0 986 481 007	25,4	
	MFD	01.94-10.96	81			JBH	0 986 481 007	25,4	
		08.96-06.03	85			JBH	0 986 481 007	25,4	
		06.97-11.01	81			JBH	0 986 481 007	25,4	
2.5 TDI	ABO	06.95-06.03	75	Fg.-Nr. 70..S..127 806→		JBH	0 986 480 930	23,81	
		05.98-06.03	65			JBH	0 986 480 930	23,81	
						254,JBH	0 986 481 030	25,4	
		05.99-06.03	75			JBH	0 986 480 930	23,81	
	ABO,	01.95-05.95	75	Fg.-Nr. →70..S..127 805		JBH	F 026 003 563	22	
	OFD								
	ABS	01.95-05.95	75	Fg.-Nr. →70..S..127 805		JBH	0 986 480 834	22,2	
	ABS,	01.95-06.03	75			254,JBH	0 986 481 007	25,4	
	OFD	06.95-06.03	75	Fg.-Nr. 70..S..127 806→		JBH	0 986 480 933	23,81	
		05.98-06.03	65/111			JBH	0 986 480 933	23,81	
						254,JBH	0 986 481 007	25,4	
		05.99-06.03	75			JBH	0 986 480 933	23,81	
	MFD	01.95-06.03	75			JBH	0 986 481 007	25,4	
		05.98-06.03	65			JBH	0 986 481 007	25,4	
			111			JBH	0 986 481 007	25,4	
2.5 TDI Syncro	ABO	03.98-06.03	75			JBH	0 986 480 930	23,81	
	ABS	04.01-06.03	75			JBH	0 986 480 933	23,81	
	ABS,	03.98-06.03	75			JBH	0 986 480 933	23,81	
	OFD					254,JBH	0 986 481 007	25,4	
	MFD	03.98-06.03	75			JBH	0 986 481 007	25,4	
2.5 TDI, TDI Syncro	ABO	01.95-06.03	75			254,JBH	0 986 481 030	25,4	
2.8	ABO	01.96-06.03	103/150			JBH	0 986 480 930	23,81	
						254,JBH	0 986 481 030	25,4	
	ABS,	01.96-05.00	103			JBH	0 986 480 933	23,81	
	OFD					254,JBH	0 986 481 007	25,4	
		05.00-06.03	150			JBH	0 986 480 933	23,81	
						254,JBH	0 986 481 007	25,4	
	MFD	01.96-05.00	103			JBH	0 986 481 007	25,4	
		05.00-06.03	150			JBH	0 986 481 007	25,4	
	1.9 D	09.90-06.03	45/50			TW	0 986 486 037	19,05	
	1.9 D Turbo						0 986 486 048	15,87	
	2.0	09.90-06.03	62			TW	0 986 486 037	19,05	
							0 986 486 048	15,87	
	2.4 D	09.90-06.03	55/57			TW	0 986 486 037	19,05	
	2.4 D Syncro						0 986 486 048	15,87	
	2.5	11.90-06.03	81/85/111			TW	0 986 486 037	19,05	
	2.5 Syncro, TDI						0 986 486 048	15,87	
	2.5 TDI	01.95-06.03	75			TW	0 986 486 048	15,87	
		05.98-06.03	65			TW	0 986 486 037	19,05	
							0 986 486 048	15,87	
	2.5 TDI Syncro	03.98-06.03	75			TW	0 986 486 048	15,87	
		04.01-06.03	75				0 986 486 048	15,87	
	2.5 TDI, TDI Syncro	01.95-06.03	75			TW	0 986 486 037	19,05	
	2.8	01.96-06.03	103/150			TW	0 986 486 037	19,05	
							0 986 486 048	15,87	





◀ VW Multivan T4 [70, 7D]





















	1.9 D	09.90-04.97	45		0 986 486 537	23,8
	1.9 D Turbo	10.92-04.97	50		0 986 486 537	23,8
		05.97-06.03	50		0 986 486 576	19
	2.0	09.90-04.97	62		0 986 486 537	23,8
		05.97-06.03	62		0 986 486 576	19
	2.4 D	05.97-06.03	55		0 986 486 576	19
	2.4 D	09.90-04.97	57		0 986 486 537	23,8
	2.4 D Syncro	05.97-09.98	57		0 986 486 576	19
	2.5	11.90-04.97	81/85		0 986 486 537	23,8
	2.5 Syncro	05.97-06.03	81/85		0 986 486 576	19
	2.5 TDI	05.98-06.03	65		0 986 486 576	19
	2.8	05.00-06.03	150		0 986 486 576	19

	1.9 D, D Turbo	09.90-06.03	45/50		0 986 482 036 ^A	
	2.0	09.90-06.03	62		0 986 482 036 ^A	
	2.4 D, D Syncro	09.90-06.03	55/57		0 986 482 036 ^A	
	2.5, Syncro, TDI, TDI Syncro	11.90-06.03	65/75/81/85/111		0 986 482 036 ^A	
	2.8	01.96-06.03	103/150		0 986 482 036 ^A	

	1.9 D	09.90-06.03	45/50		0 265 202 454 ^M	
	1.9 D Turbo	01.96-06.03	45/50		0 265 220 434 ^F	
		09.90-06.03	62		0 265 202 454 ^M	
	2.0	01.96-06.03	62		0 265 220 434 ^F	
		09.90-06.03	55/57		0 265 202 454 ^M	
	2.4 D	01.96-06.03	55/57		0 265 220 434 ^F	
	2.4 D Syncro	11.90-06.03	65/75/81/85/111		0 265 202 454 ^M	
	2.5, Syncro, TDI, TDI Syncro	01.96-06.03	65/75/81/85/111		0 265 220 434 ^F	
		11.90-06.03	65/75/81/85/111		0 265 202 454 ^M	
	2.8	01.96-05.00	103		0 265 202 454 ^M	
		10.97-05.00	103	Fg.-Nr. 70..W..062 420→	0 265 220 434 ^F	
05.00-06.03		150		0 265 202 454 ^M		

	1.9 D	09.90-12.95	45/50		0 265 100 072 ^H		
	1.9 D Turbo	09.90-06.03	45/50	1KX,326	0 265 109 612 ^M		
				281,284,GRG	0 265 109 602 ^M		
	2.0	09.90-12.95	62		0 265 100 072 ^H		
				09.90-06.03	62	1KX,326	0 265 109 612 ^M
				281,284,GRG	0 265 109 602 ^M		
				1KX,326	0 265 109 612 ^M		
	2.4 D	05.97-06.03	55	281,284,GRG	0 265 109 602 ^M		
	2.4 D	09.90-12.95	57		0 265 100 072 ^H		
	2.4 D Syncro	09.90-09.98	57	1KX,326	0 265 109 612 ^M		
				281,284,GRG	0 265 109 602 ^M		
	2.5	11.90-12.95	81		0 265 100 072 ^H		
	2.5 Syncro	11.90-06.03	81	1KX,326	0 265 109 612 ^M		
				281,284,GRG	0 265 109 602 ^M		
	2.5, Syncro, TDI	08.96-06.03	85/111	1KX,326	0 265 109 612 ^M		
				281,284,GRG	0 265 109 602 ^M		
	2.5 TDI	01.95-12.95	75		0 265 100 072 ^H		
				01.95-06.03	75	1KX,326	0 265 109 612 ^M
			05.98-06.03	65	281,284,GRG	0 265 109 602 ^M	
				1KX,326	0 265 109 612 ^M		
				281,284,GRG	0 265 109 602 ^M		
	2.5 TDI Syncro	03.98-06.03	75	1KX,326	0 265 109 612 ^M		
				281,284,GRG	0 265 109 602 ^M		
				04.01-05.02	75	Fg.-Nr. →70..3..019 101	GRG
		06.02-06.03	75	Fg.-Nr. 70..3..019 102→		0 265 109 612 ^M	
	2.8	01.96-06.03	103/150	1KX,326	0 265 109 612 ^M		
				281,284,GRG	0 265 109 602 ^M		

	1.9 D, D Turbo	09.90-06.03	45/50		0 265 005 214	
	2.0	09.90-06.03	62		0 265 005 214	

		S							
2.4 D, D Syncro				09.90-06.03	55/57		0 265 005 214		
2.5, Syncro, TDI, TDI Syncro				11.90-06.03	65/75/81/85/111		0 265 005 214		
2.8				01.96-06.03	103/150		0 265 005 214		
Multivan T5 [7E]									
									
	2.0 TDI, TDI 4Motion, TSI, TSI 4Motion			09.09→	100/103/110/ 132/150		0 986 486 595	29	
Multivan T5 [7H]									
									
	1.9 TDI			04.03-11.09	62/63/75/77	JBH	0 986 480 992	27	
	2.0			06.03-11.09	85	JBH	0 986 480 992	27	
	2.5 TDI			02.03-11.09	96	JBH,LLE	0 986 480 992	27	
					128	JBH,LLE	0 986 480 992	27	
				11.03-11.09	120	JBH	0 986 480 992	27	
				01.06-11.09	96	PR-Code 1AT JBH	0 986 480 992	27	
					128	PR-Code 1AT JBH	0 986 480 992	27	
	2.5 TDI 4Motion			07.04-11.09	96	JBH,LLE	0 986 480 992	27	
					128	JBH,LLE	0 986 480 992	27	
				01.06-11.09	96	JBH	0 986 480 992	27	
					128	JBH	0 986 480 992	27	
	3.2			02.03-06.04	170	JBH	0 986 480 992	27	
				05.03-11.09	173	JBH	0 986 480 992	27	
	3.2 4Motion			07.04-11.09	173	JBH	0 986 480 992	27	
	2.5 TDI, TDI 4Motion			02.03-11.09	96/120/128		0 986 486 595	29	
	3.2, 4Motion			02.03-11.09	170/173		0 986 486 595	29	
Multivan T6 [SG]									
									
	2.0 TDI, TDI 4Motion, TFSI			04.15→	103/110/132/150		0 986 486 595	29	
Multivan T6 [SSG]									
									
	2.0 TDI 4Motion			04.15→	103		0 986 486 595	29	
New Beetle Cabriolet [1Y7]									
									
	1.4	OFD		01.03-06.05	55	LLE	F 026 003 339	23,81	
				01.03-09.10	55	RLE	0 204 123 406	23,81	
	1.6	OFD		01.03-06.05	75	LLE	F 026 003 339	23,81	
				01.03-09.10	75	RLE	0 204 123 406	23,81	
	1.8 T	OFD		01.03-06.05	110	LLE	F 026 003 339	23,81	
				01.03-09.10	110	RLE	0 204 123 406	23,81	
	1.9 TDI	OFD		06.03-06.05	74	LLE	F 026 003 339	23,81	
				06.03-06.06	74	RLE	0 204 123 406	23,81	
				07.05-09.10	77	RLE	0 204 123 406	23,81	
	2.0	OFD		01.03-06.05	85	LLE	F 026 003 339	23,81	
				01.03-10.10	85	RLE	0 204 123 406	23,81	
	2.5	OFD		07.05-09.10	110	RLE	0 204 123 406	23,81	
	1.4	OFD		01.03-09.10	55	RLE	0 204 125 505		
	1.6	OFD		01.03-09.10	75	RLE	0 204 125 505		
	1.8 T	OFD		01.03-09.10	110	RLE	0 204 125 505		



◀ VW New Beetle Cabriolet [1Y7]

1.9 TDI	OFD	06.03-09.10	74/77		RLE	0 204 125 505	
2.0	OFD	01.03-10.10	85		RLE	0 204 125 505	
2.5	OFD	07.05-09.10	110		RLE	0 204 125 505	













	1.4		01.03-09.10	55		LLE	0 986 486 031	15,87
	1.6		01.03-09.10	75		LLE	0 986 486 031	15,87
	1.8 T		01.03-09.10	110		LLE	0 986 486 031	15,87
	1.9 TDI		06.03-09.10	74/77		LLE	0 986 486 031	15,87
	2.0		01.03-10.10	85		LLE	0 986 486 031	15,87
	2.5		07.05-09.10	110		LLE	0 986 486 031	15,87

	1.4		01.03-09.10	55	PR-Code OEJ	0 986 486 538	19
					PR-Code OEM	0 986 486 554	19,05
	1.6		01.03-09.10	75	PR-Code OEJ	0 986 486 538	19
					PR-Code OEM	0 986 486 554	19,05
	1.8 T		01.03-06.04	110	PR-Code OEJ	0 986 486 576	19
			01.03-09.10	110	PR-Code OEM	0 986 486 554	19,05
			12.03-09.10	110	PR-Code OEJ	0 986 486 538	19
	1.9 TDI		06.03-09.10	74/77	PR-Code OEJ	0 986 486 538	19
					PR-Code OEM	0 986 486 554	19,05
	2.0		01.03-07.05	85	PR-Code OEJ	0 986 486 576	19
			01.03-10.10	85	PR-Code OEJ	0 986 486 538	19
	2.5		07.05-09.10	110	PR-Code OEJ	0 986 486 576	19
PR-Code OEM					0 986 486 554	19,05	

New Beetle [1C1/9C1]











	1.4	OFD	11.01-06.05	55		LLE	BO	F 026 003 339	23,81		
			11.01-09.10	55		RLE		0 204 123 406	23,81		
	1.6	MFD	10.99-05.01	74/75		JBH,LLE, M20			0 986 481 022	23,81	
					OFD	10.99-10.00	74	LLE		F 026 003 339	23,81
								RLE		0 204 123 406	23,81
						06.00-12.10	75	RLE		0 204 123 406	23,81
						06.01-06.05	75	LLE	BO	F 026 003 339	23,81
								LLE	BO	F 026 003 339	23,81
	1.8 T	MFD	01.98-05.01	110	PR-Code 1AC, PR-Code 1AJ	LLE	BO	F 026 003 339	23,81		
						JBH,LLE, M20			0 986 481 022	23,81	
						06.01-06.04	110	LLE	BO	F 026 003 339	23,81
					OFD	01.98-05.01	110	LLE		F 026 003 339	23,81
						01.98-12.10	110	RLE		0 204 123 406	23,81
						10.00-06.05	110	LLE	BO	F 026 003 339	23,81
						06.01-07.05	132	RLE		0 204 123 406	23,81
						07.04-06.05	132	LLE	BO	F 026 003 339	23,81
	1.9 TDI	MFD	01.98-05.01	66	PR-Code 1AC, PR-Code 1AJ	LLE	BO	F 026 003 339	23,81		
						JBH,LLE, M20			0 986 481 022	23,81	
						10.00-05.01	74	JBH,LLE, M20		0 986 481 022	23,81
						06.01-06.04	66	LLE	BO	F 026 003 339	23,81
						06.01-06.05	74	LLE	BO	F 026 003 339	23,81
					OFD	01.98-06.04	66	RLE		0 204 123 406	23,81
						10.00-12.10	74	RLE		0 204 123 406	23,81
						07.04-06.05	74	LLE	BO	F 026 003 339	23,81
						07.05-12.10	77	RLE		0 204 123 406	23,81
					2.0	MFD	01.98-05.01	85	PR-Code 1AC, PR-Code 1AJ	LLE	BO
		JBH,LLE, M20							0 986 481 022	23,81	
		06.01-06.05	85	LLE					BO	F 026 003 339	23,81
	OFD	01.98-09.10	85	RLE						0 204 123 406	23,81
					LLE	BO	F 026 003 339	23,81			

		S							
2.3		MFD	10.00-05.01	125		JBH,LLE, M20	0 986 481 022	23,81	
			06.01-06.05	125		LLE BO	F 026 003 339	23,81	
		OFD	10.00-06.05	125		RLE	0 204 123 406	23,81	
2.5		OFD	07.05-09.10	110		RLE	0 204 123 406	23,81	
3.2 RSI 4x4		MFD	10.00-05.01	165		JBH,LLE, M20	0 986 481 022	23,81	
		OFD	10.00-05.01	165		LLE	F 026 003 339	23,81	
						RLE	0 204 123 406	23,81	
	1.4	OFD	11.01-09.10	55		RLE	0 204 125 505		
	1.6	OFD	10.99-12.10	74/75		RLE	0 204 125 505		
	1.8 T	OFD	01.98-12.10	110/132		RLE	0 204 125 505		
	1.9 TDI	OFD	01.98-12.10	66/74/77		RLE	0 204 125 505		
	2.0	OFD	01.98-09.10	85		RLE	0 204 125 505		
	2.3	OFD	10.00-06.05	125		RLE	0 204 125 505		
	2.5	OFD	07.05-09.10	110		RLE	0 204 125 505		
	3.2 RSI 4x4	OFD	10.00-05.01	165		RLE	0 204 125 505		
	1.4		11.01-09.10	55		LLE	0 986 486 031	15,87	
	1.6		10.99-12.10	74/75		LLE	0 986 486 031	15,87	
	1.8 T		01.98-12.10	110/132		LLE	0 986 486 031	15,87	
	1.9 TDI		01.98-12.10	66/74/77		LLE	0 986 486 031	15,87	
	2.0		01.98-09.10	85		LLE	0 986 486 031	15,87	
	2.3		10.00-06.05	125		LLE	0 986 486 031	15,87	
	2.5		07.05-09.10	110		LLE	0 986 486 031	15,87	
	3.2 RSI 4x4		10.00-05.01	165		LLE	0 986 486 031	15,87	
	1.4		11.01-09.10	55	PR-Code OEJ		0 986 486 538	19	
					PR-Code OEM		0 986 486 554	19,05	
	1.6		10.99-10.00	74	PR-Code OEJ		0 986 486 576	19	
					PR-Code OEM		0 986 486 554	19,05	
			06.00-06.05	75			0 986 486 538	19	
			06.02-12.10	75	PR-Code OEJ		0 986 486 538	19	
					PR-Code OEM		0 986 486 554	19,05	
	1.8 T		01.98-06.05	110	PR-Code OEJ		0 986 486 576	19	
			01.98-12.10	110	PR-Code OEM		0 986 486 554	19,05	
			10.00-12.10	110	PR-Code OEJ		0 986 486 538	19	
			06.01-07.05	132			0 986 486 595	29	
	1.9 TDI		01.98-06.04	66	PR-Code OEJ		0 986 486 576	19	
					PR-Code OEM		0 986 486 554	19,05	
			10.00-12.06	74	PR-Code OEJ		0 986 486 576	19	
			10.00-12.10	74	PR-Code OEM		0 986 486 554	19,05	
			07.04-12.10	74	PR-Code OEJ		0 986 486 538	19	
			07.05-12.10	77	PR-Code OEJ		0 986 486 538	19	
					PR-Code OEM		0 986 486 554	19,05	
	2.0		01.98-06.07	85	PR-Code OEJ		0 986 486 576	19	
			01.98-09.10	85	PR-Code OEM		0 986 486 554	19,05	
			11.98-06.05	85			0 986 486 538	19	
			06.01-09.10	85	PR-Code OEJ		0 986 486 538	19	
	2.3		10.00-06.05	125			0 986 486 576	19	
	2.5		07.05-09.10	110	PR-Code OEJ		0 986 486 576	19	
					PR-Code OEM		0 986 486 554	19,05	
	3.2 RSI 4x4		10.00-05.01	165			0 986 486 576	19	
Passat Alltrack [365]									
									
	1.8 TFSI		01.12→	112/118	PR-Code OEJ		0 986 486 576	19	
					PR-Code OEN		0 986 486 595	29	
	2.0 TDI, TDI 4Motion		01.12→	103			0 986 486 595	29	

			S									
◀ VW												
Passat [B5]												
	1.8 i		01.98-04.04	92			JBH	0986 480 935	25,4			
Passat CC [357]												
	1.4 TSI		01.11-05.12	118	PR-Code OEJ			0986 486 576	19			
	1.8 TSI		05.08-05.12	112/118	PR-Code OEJ			0986 486 576	19			
	2.0 TDI, TDI 4Motion, TSI		05.08-05.12	100/103/105/125/147/155				0986 486 595	29			
	3.6 FSI, FSI 4Motion		05.08-05.12	206/220	PR-Code OEJ			0986 486 576	19			
Passat Variant [3B5]												
	1.6	MFD	01.97-04.99	74	Fg.-Nr. →3B..X..600 000	JBH	0986 480 974	23,8				
			05.99-11.00	74	Fg.-Nr. 3B..Y..000 001→	JBH,LLE	0986 480 966	25,4				
							JBH,RLE	0986 480 989	25,4			
					07.99-11.00	74		JBH,LLE	0986 480 966	25,4		
								JBH,RLE	0986 480 989	25,4		
				OFD	01.97-04.99	74	Fg.-Nr. →3B..X..600 000	JBH	0986 480 890	23,81		
			05.99-11.00		74	Fg.-Nr. 3B..Y..000 001→	JBH,LLE	0986 480 935	25,4			
			07.99-11.00		74		JBH,LLE	0986 480 935	25,4			
		1.8	MFD	05.97-04.99	85	Fg.-Nr. →3B..X..600 000	JBH	0986 480 974	23,8			
					05.99-11.00	85	Fg.-Nr. 3B..Y..000 001→	JBH,LLE	0986 480 966	25,4		
								JBH,RLE	0986 480 989	25,4		
				OFD	05.97-04.99	85	Fg.-Nr. →3B..X..600 000	JBH	0986 480 890	23,81		
			05.99-11.00		85	Fg.-Nr. 3B..Y..000 001→	JBH,LLE	0986 480 935	25,4			
							JBH,LLE	0986 480 935	25,4			
	1.8	MFD	05.97-01.99	92		JBH	0986 480 974	23,8				
				01.99-04.99	92	Fg.-Nr. →3B..X..600 000	JBH	0986 480 974	23,8			
				05.99-11.00	92	Fg.-Nr. 3B..Y..000 001→	JBH,LLE	0986 480 966	25,4			
			OFD	05.97-01.99	92		JBH	0986 480 890	23,81			
				01.99-04.99	92	Fg.-Nr. →3B..X..600 000	JBH	0986 480 890	23,81			
				05.99-11.00	92	Fg.-Nr. 3B..Y..000 001→	JBH,LLE	0986 480 935	25,4			
	1.8 Turbo	MFD	05.97-04.99	110	Fg.-Nr. →3B..X..600 000	JBH	0986 480 974	23,8				
				05.99-11.00	110	Fg.-Nr. 3B..Y..000 001→	JBH,LLE	0986 480 966	25,4			
							JBH,RLE	0986 480 989	25,4			
			OFD	05.97-04.99	110	Fg.-Nr. →3B..X..600 000	JBH	0986 480 890	23,81			
				05.99-11.00	110	Fg.-Nr. 3B..Y..000 001→	JBH,LLE	0986 480 935	25,4			
							JBH,LLE	0986 480 935	25,4			
	1.9 TDI	MFD	05.97-04.99	66	Fg.-Nr. →3B..X..600 000	JBH	0986 480 974	23,8				
				05.99-11.00	66	Fg.-Nr. 3B..Y..000 001→	JBH,LLE	0986 480 966	25,4			
							JBH,RLE	0986 480 989	25,4			
			OFD	02.00-11.00	74	Fg.-Nr. 3B..Y..000 001→	JBH,LLE	0986 480 966	25,4			
							JBH,RLE	0986 480 989	25,4			
				05.97-04.99	66	Fg.-Nr. →3B..X..600 000	JBH	0986 480 890	23,81			
				05.99-11.00	66	Fg.-Nr. 3B..Y..000 001→	JBH,LLE	0986 480 935	25,4			
					02.00-11.00	74	Fg.-Nr. 3B..Y..000 001→	JBH,LLE	0986 480 935	25,4		
							JBH,LLE	0986 480 935	25,4			
	1.9 TDI	MFD	05.97-04.99	81/85	Fg.-Nr. →3B..X..600 000	JBH	0986 480 974	23,8				
				05.99-11.00	81/85	Fg.-Nr. 3B..Y..000 001→	JBH,LLE	0986 480 966	25,4			
							JBH,RLE	0986 480 989	25,4			
			OFD	08.99-11.00	81/85		JBH,LLE	0986 480 966	25,4			
							JBH,RLE	0986 480 989	25,4			
				05.97-04.99	81/85	Fg.-Nr. →3B..X..600 000	JBH	0986 480 890	23,81			
	1.9 TDI syncro	MFD	05.99-11.00	81/85	Fg.-Nr. 3B..Y..000 001→	JBH,LLE	0986 480 935	25,4				
							JBH,LLE	0986 480 935	25,4			
				08.99-11.00	81/85		JBH,LLE	0986 480 935	25,4			
	2.3	MFD	09.97-04.99	110	Fg.-Nr. →3B..X..600 000	JBH	0986 480 974	23,8				
				05.99-11.00	110	Fg.-Nr. 3B..Y..000 001→	JBH,LLE	0986 480 966	25,4			
							JBH,RLE	0986 480 989	25,4			





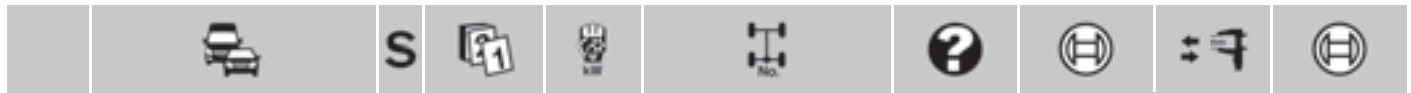







		S							
2.3	OFD	09.97-04.99	110	Fg.-Nr. →3B..X..600 000	JBH		0 986 480 890	23,81	
2.3 syncro		05.99-11.00	110	Fg.-Nr. 3B..Y..000 001→	JBH,LLE		0 986 480 935	25,4	
2.5 TDI	MFD	08.98-04.99	110	Fg.-Nr. →3B..X..600 000	JBH		0 986 480 974	23,8	
2.5 TDI syncro		05.99-11.00	110		JBH,LLE		0 986 480 966	25,4	
					JBH,RLE		0 986 480 989	25,4	
	OFD	08.98-04.99	110	Fg.-Nr. →3B..X..600 000	JBH		0 986 480 890	23,81	
		05.99-11.00	110		JBH,LLE		0 986 480 935	25,4	
2.8	MFD	10.99-11.00	140		JBH,LLE		0 986 480 966	25,4	
					JBH,RLE		0 986 480 989	25,4	
	OFD	10.99-11.00	140		JBH,LLE		0 986 480 935	25,4	
2.8	MFD	01.97-04.99	142	Fg.-Nr. →3B..X..600 000	JBH		0 986 480 974	23,8	
2.8 syncro		05.99-11.00	142		JBH,LLE		0 986 480 966	25,4	
					JBH,RLE		0 986 480 989	25,4	
	OFD	01.97-04.99	142	Fg.-Nr. →3B..X..600 000	JBH		0 986 480 890	23,81	
		05.99-11.00	142		JBH,LLE		0 986 480 935	25,4	
1.6		01.97-02.97	74	Fg.-Nr. →3B..V..100 000	LLE		0 986 486 083	19	
		03.97-11.00	74	Fg.-Nr. 3B..V..100 001→	LLE		0 986 486 054	19,05	
		05.97-11.00	74		LLE		0 986 486 054	19,05	
1.8, syncro, Turbo		05.97-11.00	85/92/110		LLE		0 986 486 054	19,05	
1.9 TDI		05.97-06.97	66	Fg.-Nr. →3B..W..070 000	EFV,LLE		0 986 486 083	19	
			81	Fg.-Nr. →3B..W..070 000	EFV,LLE		0 986 486 083	19	
		07.97-11.00	66	Fg.-Nr. 3B..W..070 001→	LLE		0 986 486 054	19,05	
			81	Fg.-Nr. 3B..W..070 001→	LLE		0 986 486 054	19,05	
		05.98-11.00	66		LLE		0 986 486 054	19,05	
		08.99-11.00	81		LLE		0 986 486 054	19,05	
		02.00-11.00	74		LLE		0 986 486 054	19,05	
1.9 TDI syncro		06.97-08.00	81		LLE		0 986 486 054	19,05	
1.9 TDI, TDI syncro		01.99-11.00	85		LLE		0 986 486 054	19,05	
2.3, syncro		09.97-11.00	110		LLE		0 986 486 054	19,05	
2.5 TDI		05.99-11.00	110	Fg.-Nr. 3B..W..070 001→	LLE		0 986 486 083	19	
2.5 TDI, TDI syncro		08.98-11.00	110		LLE		0 986 486 054	19,05	
2.8, syncro		01.97-11.00	140/142		LLE		0 986 486 054	19,05	
1.6		01.97-02.97	74	Fg.-Nr. →3B..V..100 000			0 986 486 551	22,2	
		03.97-11.00	74	Fg.-Nr. 3B..V..100 001→			0 986 486 548	22,2	
		05.97-11.00	74				0 986 486 548	22,2	
1.8, syncro, Turbo		05.97-11.00	85/92/110				0 986 486 548	22,2	
1.9 TDI		05.97-06.97	66	Fg.-Nr. →3B..W..070 000			0 986 486 551	22,2	
		07.97-11.00	66	Fg.-Nr. 3B..W..070 001→			0 986 486 548	22,2	
		05.98-11.00	66				0 986 486 548	22,2	
		02.00-11.00	74				0 986 486 548	22,2	
1.9 TDI		05.97-06.97	81	Fg.-Nr. →3B..W..070 000			0 986 486 551	22,2	
1.9 TDI syncro		07.97-11.00	81	Fg.-Nr. 3B..W..070 001→			0 986 486 548	22,2	
		01.99-11.00	85				0 986 486 548	22,2	
		08.99-11.00	81				0 986 486 548	22,2	
2.3, syncro		09.97-11.00	110				0 986 486 548	22,2	
2.5 TDI, TDI syncro		08.98-11.00	110				0 986 486 548	22,2	
2.8, syncro		01.97-11.00	140/142				0 986 486 548	22,2	
1.6		01.97-05.97	74	Fg.-Nr. →3B..W..030 000			0 265 220 440 ^E		
							0 265 220 446 ^F		
		01.97-11.00	74				0 265 202 403 ^M		
					CS2		0 265 216 564 ^B		
		06.97-11.98	74	Fg.-Nr. 3B..W..030 001→ 3B..X..300 000	CS2		0 265 220 413 ^F		
		06.97-11.00	74	Fg.-Nr. 3B..W..030 001→	CS2		0 265 220 407 ^E		
		12.98-04.00	74	Fg.-Nr. 3B..X..300 001→ 3B..YE399 201	CS2		0 265 220 527 ^F		
		01.99-04.00	74	Fg.-Nr. →3B..YE399 201	CS2		0 265 220 527 ^F		
		01.99-11.00	74		CS2		0 265 220 407 ^E		
		05.00-11.00	74	Fg.-Nr. 3B..YE399 202→	CS2		0 265 220 639 ^F		



◀ VW Passat Variant [3B5]

1.8	05.97-05.97	85/92	Fg.-Nr. →3B..W..030 000		0 265 220 440 ^E
					0 265 220 446 ^F
	05.97-11.00	85			0 265 202 403 ^M
				CS2	0 265 216 564 ^B
		92		CS2	0 265 216 564 ^B
	06.97-11.98	85/92	Fg.-Nr. 3B..W..030 001→ 3B..X..300 000	CS2	0 265 220 413 ^F
	06.97-01.99	92	Fg.-Nr. 3B..W..030 001→	CS2	0 265 220 407 ^E
	06.97-11.00	85	Fg.-Nr. 3B..W..030 001→	CS2	0 265 220 407 ^E
	12.98-01.99	92	Fg.-Nr. 3B..X..300 001→	CS2	0 265 220 527 ^F
	12.98-04.00	85	Fg.-Nr. 3B..X..300 001→ 3B..YE399 201	CS2	0 265 220 527 ^F
01.99-04.00	92	Fg.-Nr. →3B..YE399 201	CS2	0 265 220 527 ^F	
01.99-11.00	92		CS2	0 265 220 407 ^E	
05.00-11.00	85/92	Fg.-Nr. 3B..YE399 202→	CS2	0 265 220 639 ^F	
1.8, syncro	05.97-11.00	92			0 265 220 403 ^M
1.8 syncro	08.97-08.00	92		CS2	0 265 220 410 ^E
1.8 Turbo	05.97-05.97	110	Fg.-Nr. →3B..W..030 000		0 265 220 440 ^E
					0 265 220 446 ^F
	05.97-11.00	110			0 265 202 403 ^M
				CS2	0 265 216 564 ^B
	06.97-11.98	110	Fg.-Nr. 3B..W..030 001→ 3B..X..300 000	CS2	0 265 220 413 ^F
	06.97-11.00	110	Fg.-Nr. 3B..W..030 001→	CS2	0 265 220 407 ^E
	12.98-04.00	110	Fg.-Nr. 3B..X..300 001→ 3B..YE399 201	CS2	0 265 220 527 ^F
	01.99-04.00	110	Fg.-Nr. →3B..YE399 201	CS2	0 265 220 527 ^F
	01.99-11.00	110		CS2	0 265 220 407 ^E
	05.00-11.00	110	Fg.-Nr. 3B..YE399 202→	CS2	0 265 220 639 ^F
1.9 TDI	05.97-05.97	66	Fg.-Nr. →3B..W..030 000		0 265 220 440 ^E
					0 265 220 446 ^F
		81	Fg.-Nr. →3B..W..030 000		0 265 220 440 ^E
					0 265 220 446 ^F
	05.97-11.00	66			0 265 202 403 ^M
				CS2	0 265 216 564 ^B
		81		CS2	0 265 216 564 ^B
	06.97-11.98	66	Fg.-Nr. 3B..W..030 001→ 3B..X..300 000	CS2	0 265 220 413 ^F
		81	Fg.-Nr. 3B..W..030 001→ 3B..X..300 000	CS2	0 265 220 413 ^F
	06.97-11.00	66	Fg.-Nr. 3B..W..030 001→	CS2	0 265 220 407 ^E
		81	Fg.-Nr. 3B..W..030 001→	CS2	0 265 220 407 ^E
	05.98-11.98	66	Fg.-Nr. →3B..X..300 000	CS2	0 265 220 413 ^F
	05.98-11.00	66		CS2	0 265 220 407 ^E
	12.98-04.00	66	Fg.-Nr. 3B..X..300 001→ 3B..YE399 201	CS2	0 265 220 527 ^F
		81	Fg.-Nr. 3B..X..300 001→ 3B..YE399 201	CS2	0 265 220 527 ^F
	01.99-04.00	85	Fg.-Nr. →3B..YE399 201	CS2	0 265 220 527 ^F
	01.99-11.00	85		CS2	0 265 216 564 ^B
					0 265 220 407 ^E
	08.99-04.00	81	Fg.-Nr. →3B..YE399 201	CS2	0 265 220 527 ^F
	08.99-11.00	81		CS2	0 265 220 407 ^E
02.00-04.00	74	Fg.-Nr. →3B..YE399 201	CS2	0 265 220 527 ^F	
02.00-11.00	74			0 265 202 403 ^M	
			CS2	0 265 216 564 ^B	
				0 265 220 407 ^E	
05.00-11.00	66	Fg.-Nr. 3B..YE399 202→	CS2	0 265 220 639 ^F	
	74	Fg.-Nr. 3B..YE399 202→	CS2	0 265 220 639 ^F	
	81	Fg.-Nr. 3B..YE399 202→	CS2	0 265 220 639 ^F	
	85	Fg.-Nr. 3B..YE399 202→	CS2	0 265 220 639 ^F	
1.9 TDI syncro	06.97-08.00	81		CS2	0 265 220 410 ^E
	01.00-08.00	85		CS2	0 265 220 410 ^E



		S							
1.9 TDI		05.97-11.00	81					0 265 202 403 ^M	
1.9 TDI syncro		01.99-11.00	85					0 265 202 403 ^M	
2.3		09.97-11.98	110	Fg.-Nr. →3B..X..300 000		CS2		0 265 220 413 ^F	
		09.97-11.00	110			CS2		0 265 216 564 ^B	
								0 265 220 407 ^E	
		12.98-04.00	110	Fg.-Nr. 3B..X..300 001→ 3B..YE399 201		CS2		0 265 220 527 ^F	
		05.00-11.00	110	Fg.-Nr. 3B..YE399 202→		CS2		0 265 220 639 ^F	
2.3, syncro		09.97-11.00	110					0 265 202 403 ^M	
2.3 syncro		09.97-08.00	110			CS2		0 265 220 410 ^E	
2.5 TDI		08.98-04.00	110	Fg.-Nr. →3B..YE399 201		CS2		0 265 220 527 ^F	
		08.98-11.00	110			CS2		0 265 216 564 ^B	
								0 265 220 407 ^E	
		05.00-11.00	110	Fg.-Nr. 3B..YE399 202→		CS2		0 265 220 639 ^F	
2.5 TDI syncro		02.99-08.00	110			CS2		0 265 220 410 ^E	
2.5 TDI, TDI syncro		08.98-11.00	110					0 265 202 403 ^M	
2.8		06.97-11.98	142	Fg.-Nr. →3B..X..300 000		CS2		0 265 220 413 ^F	
		06.97-11.00	142			CS2		0 265 216 564 ^B	
								0 265 220 407 ^E	
		12.98-04.00	142	Fg.-Nr. 3B..X..300 001→ 3B..YE399 201		CS2		0 265 220 527 ^F	
		01.99-04.00	142	Fg.-Nr. →3B..YE399 201		CS2		0 265 220 527 ^F	
		10.99-04.00	140	Fg.-Nr. →3B..YE399 201		CS2		0 265 220 527 ^F	
		10.99-11.00	140					0 265 202 403 ^M	
						CS2		0 265 216 564 ^B	
								0 265 220 407 ^E	
		05.00-11.00	140	Fg.-Nr. 3B..YE399 202→		CS2		0 265 220 639 ^F	
			142	Fg.-Nr. 3B..YE399 202→		CS2		0 265 220 639 ^F	
2.8, syncro		01.97-11.00	142					0 265 202 403 ^M	
2.8 syncro		01.97-08.00	142			CS2		0 265 220 410 ^E	
1.6		01.97-11.00	74					0 265 109 463 ^M	
		05.97-11.00	85					0 265 109 463 ^M	
			92					0 265 109 463 ^M	
1.8 syncro		08.97-08.99	92	Fg.-Nr. →3B..Y..100 000		GRG		0 265 109 426 ^M	
		09.99-08.00	92	Fg.-Nr. 3B..Y..100 001→		GRG		0 265 109 462 ^M	
1.8 Turbo		05.97-11.00	110					0 265 109 463 ^M	
1.9 TDI		05.97-11.00	66/74					0 265 109 463 ^M	
			81					0 265 109 463 ^M	
		01.99-11.00	85					0 265 109 463 ^M	
1.9 TDI syncro		06.97-08.99	81	Fg.-Nr. →3B..Y..100 000		GRG		0 265 109 426 ^M	
		09.99-08.00	81	Fg.-Nr. 3B..Y..100 001→		GRG		0 265 109 462 ^M	
		01.00-08.00	85			GRG		0 265 109 462 ^M	
2.3		09.97-11.00	110					0 265 109 463 ^M	
2.3 syncro		09.97-08.99	110	Fg.-Nr. →3B..Y..100 000		GRG		0 265 109 426 ^M	
		09.99-08.00	110	Fg.-Nr. 3B..Y..100 001→		GRG		0 265 109 462 ^M	
2.5 TDI		08.98-11.00	110					0 265 109 463 ^M	
2.5 TDI syncro		02.99-08.99	110	Fg.-Nr. →3B..Y..100 000		GRG		0 265 109 426 ^M	
		09.99-08.00	110	Fg.-Nr. 3B..Y..100 001→		GRG		0 265 109 462 ^M	
2.8		06.97-11.00	142					0 265 109 463 ^M	
		10.99-11.00	140					0 265 109 463 ^M	
2.8 syncro		01.97-08.99	142	Fg.-Nr. →3B..Y..100 000		GRG		0 265 109 426 ^M	
		09.99-08.00	142	Fg.-Nr. 3B..Y..100 001→		GRG		0 265 109 462 ^M	
		10.99-08.00	142			GRG		0 265 109 462 ^M	
1.6		01.97-11.00	74			5PO		0 265 005 207	
						6PO		0 265 005 214	
1.8, syncro, Turbo		05.97-11.00	85/92/110			5PO		0 265 005 207	
						6PO		0 265 005 214	
1.9 TDI		05.97-11.00	66/74			5PO		0 265 005 207	
			81/85			5PO		0 265 005 207	
1.9 TDI syncro		06.97-08.00	81/85			5PO		0 265 005 207	
						6PO		0 265 005 214	





	◀ VW Passat Variant [3B5]							
	2.3	09.97-11.00	110			5PO	0 265	005 207
	2.3 syncro					6PO	0 265	005 214
	2.5 TDI	08.98-11.00	110			5PO	0 265	005 207
	2.5 TDI syncro	02.99-08.00	110			5PO	0 265	005 207
						6PO	0 265	005 214
	2.8	01.97-11.00	140/142			5PO	0 265	005 207
	2.8 syncro					6PO	0 265	005 214











Passat Variant [3B6]



	1.6	05.01-05.05	75	Fg.-Nr. 3B..2..000 001→		JBH	LUC	0 986	481 046	25,4
		MFD 10.00-04.01	75	Fg.-Nr. →3B..1..400 000		JBH,LLE		0 986	480 966	25,4
						JBH,RLE		0 986	480 989	25,4
		OFD 10.00-04.01	75	Fg.-Nr. →3B..1..400 000		JBH,LLE		0 986	480 935	25,4
	1.8	05.01-05.05	110/125	Fg.-Nr. 3B..2..000 001→		JBH	LUC	0 986	481 046	25,4
		MFD 10.00-04.01	110/125	Fg.-Nr. →3B..1..400 000		JBH,LLE		0 986	480 966	25,4
						JBH,RLE		0 986	480 989	25,4
		OFD 10.00-04.01	110/125	Fg.-Nr. →3B..1..400 000		JBH,LLE		0 986	480 935	25,4
	1.9 TDI	05.01-05.05	74/96	Fg.-Nr. 3B..2..000 001→		JBH	LUC	0 986	481 046	25,4
	1.9 TDI 4Motion	MFD 10.00-04.01	74/96	Fg.-Nr. →3B..1..400 000		JBH,LLE		0 986	480 966	25,4
						JBH,RLE		0 986	480 989	25,4
		OFD 10.00-04.01	74/96	Fg.-Nr. →3B..1..400 000		JBH,LLE		0 986	480 935	25,4
	2.0, TDI	11.01-05.05	96/100			JBH	LUC	0 986	481 046	25,4
	2.0	05.01-05.05	85	Fg.-Nr. 3B..2..000 001→		JBH	LUC	0 986	481 046	25,4
	2.0 4Motion	MFD 10.00-04.01	85	Fg.-Nr. →3B..1..400 000		JBH,LLE		0 986	480 966	25,4
						JBH,RLE		0 986	480 989	25,4
		OFD 10.00-04.01	85	Fg.-Nr. →3B..1..400 000		JBH,LLE		0 986	480 935	25,4
	2.3	05.01-05.05	125	Fg.-Nr. 3B..2..000 001→		JBH	LUC	0 986	481 046	25,4
	2.3 4Motion	MFD 10.00-04.01	125	Fg.-Nr. →3B..1..400 000		JBH,LLE		0 986	480 966	25,4
						JBH,RLE		0 986	480 989	25,4
		OFD 10.00-04.01	125	Fg.-Nr. →3B..1..400 000		JBH,LLE		0 986	480 935	25,4
	2.5 TDI	05.01-05.03	110	Fg.-Nr. 3B..2..000 001→		JBH	LUC	0 986	481 046	25,4
	2.5 TDI 4Motion	01.03-05.05	120/132			JBH	LUC	0 986	481 046	25,4
		MFD 10.00-04.01	110	Fg.-Nr. →3B..1..400 000		JBH,LLE		0 986	480 966	25,4
						JBH,RLE		0 986	480 989	25,4
		OFD 10.00-04.01	110	Fg.-Nr. →3B..1..400 000		JBH,LLE		0 986	480 935	25,4
	2.8	05.01-05.05	140/142	Fg.-Nr. 3B..2..000 001→		JBH	LUC	0 986	481 046	25,4
	2.8 4Motion	MFD 10.00-04.01	140/142	Fg.-Nr. →3B..1..400 000		JBH,LLE		0 986	480 966	25,4
						JBH,RLE		0 986	480 989	25,4
		OFD 10.00-04.01	140/142	Fg.-Nr. →3B..1..400 000		JBH,LLE		0 986	480 935	25,4
	4.0, 4Motion	09.01-09.04	202			JBH	LUC	0 986	481 046	25,4

	1.6	10.00-05.05	75			LLE		0 986	486 054	19,05
	1.8	10.00-05.05	110/125			LLE		0 986	486 054	19,05
	1.9 TDI	10.00-05.05	74			LLE		0 986	486 054	19,05
	1.9 TDI, TDI 4Motion	10.00-05.05	96			LLE		0 986	486 061	19,05
	2.0, 4Motion	10.00-05.05	85/96			LLE		0 986	486 054	19,05
	2.0 TDI	11.03-05.05	100			LLE		0 986	486 061	19,05
	2.3, 4Motion	10.00-05.05	125			LLE		0 986	486 054	19,05
	2.5 TDI, TDI 4Motion	10.00-05.05	110/120/132			LLE		0 986	486 061	19,05
	2.8, 4Motion	10.00-05.05	140/142			LLE		0 986	486 054	19,05
	4.0, 4Motion	09.01-09.04	202			LLE		0 986	486 061	19,05

	1.6	10.00-05.05	75					0 986	486 548	22,2
	1.8	10.00-05.05	110/125					0 986	486 548	22,2
	1.9 TDI, TDI 4Motion	10.00-05.05	74/96					0 986	486 548	22,2
	2.0, TDI, 4Motion	10.00-05.05	85/96/100					0 986	486 548	22,2
	2.3, 4Motion	10.00-05.05	125					0 986	486 548	22,2
	2.5 TDI, TDI 4Motion	10.00-05.05	110/120/132					0 986	486 548	22,2
	2.8, 4Motion	10.00-05.05	140/142					0 986	486 548	22,2

		S							
	1.6	10.00-04.01	75	Fg.-Nr. →3B..1..400 000			0 265 202 403 ^M		
		10.00-05.05	75		CS2	0 265 216 564 ^B			
							0 265 220 407 ^E		
		05.01-05.05	75	Fg.-Nr. 3B..2..000 001→	CS2	0 265 225 125 ^T			
	1.8	10.00-04.01	110/125	Fg.-Nr. →3B..1..400 000		0 265 202 403 ^M			
		10.00-05.05	110/125		CS2	0 265 216 564 ^B			
						0 265 220 407 ^E			
		05.01-05.05	110/125	Fg.-Nr. 3B..2..000 001→	CS2	0 265 225 125 ^T			
	1.9 TDI	10.00-04.01	74	Fg.-Nr. →3B..1..400 000		0 265 202 403 ^M			
		10.00-05.05	74		CS2	0 265 216 564 ^B			
			96		CS2	0 265 216 564 ^B			
						0 265 220 407 ^E			
	05.01-05.05	74	Fg.-Nr. 3B..2..000 001→	CS2	0 265 225 125 ^T				
		96	Fg.-Nr. 3B..2..000 001→	CS2	0 265 225 125 ^T				
1.9 TDI, TDI 4Motion	10.00-04.01	96	Fg.-Nr. →3B..1..400 000		0 265 202 403 ^M				
1.9 TDI 4Motion	10.00-05.05	96		CS2	0 265 220 410 ^E				
	05.01-05.05	96	Fg.-Nr. 3B..2..000 001→		0 265 225 122 ^T				
2.0	10.00-05.05	85		CS2	0 265 216 564 ^B				
					0 265 220 407 ^E				
	05.01-05.05	85	Fg.-Nr. 3B..2..000 001→	CS2	0 265 225 125 ^T				
2.0	11.01-05.05	96/100		CS2	0 265 216 564 ^B				
2.0 TDI					0 265 220 407 ^E				
					0 265 225 125 ^T				
2.0, 4Motion	10.00-04.01	85	Fg.-Nr. →3B..1..400 000		0 265 202 403 ^M				
2.0 4Motion	10.00-05.05	85		CS2	0 265 220 410 ^E				
	05.01-05.05	85	Fg.-Nr. 3B..2..000 001→		0 265 225 122 ^T				
2.3	10.00-05.05	125		CS2	0 265 216 564 ^B				
					0 265 220 407 ^E				
	05.01-05.05	125	Fg.-Nr. 3B..2..000 001→	CS2	0 265 225 125 ^T				
2.3, 4Motion	10.00-04.01	125	Fg.-Nr. →3B..1..400 000		0 265 202 403 ^M				
2.3 4Motion	01.01-05.05	125		CS2	0 265 220 410 ^E				
	05.01-05.05	125	Fg.-Nr. 3B..2..000 001→		0 265 225 122 ^T				
2.5 TDI	10.00-05.03	110		CS2	0 265 216 564 ^B				
					0 265 220 407 ^E				
	05.01-05.03	110	Fg.-Nr. 3B..2..000 001→	CS2	0 265 225 125 ^T				
	05.03-05.05	120		CS2	0 265 216 564 ^B				
					0 265 220 407 ^E				
					0 265 225 125 ^T				
2.5 TDI, TDI 4Motion	10.00-04.01	110	Fg.-Nr. →3B..1..400 000		0 265 202 403 ^M				
2.5 TDI 4Motion	10.00-01.03	110		CS2	0 265 220 410 ^E				
	05.01-01.03	110	Fg.-Nr. 3B..2..000 001→		0 265 225 122 ^T				
	01.03-05.05	132			0 265 225 122 ^T				
				CS2	0 265 220 410 ^E				
2.8	10.00-05.05	140/142		CS2	0 265 216 564 ^B				
					0 265 220 407 ^E				
	05.01-05.05	140/142	Fg.-Nr. 3B..2..000 001→	CS2	0 265 225 125 ^T				
2.8, 4Motion	10.00-04.01	140/142	Fg.-Nr. →3B..1..400 000		0 265 202 403 ^M				
2.8 4Motion	10.00-05.05	140/142		CS2	0 265 220 410 ^E				
	05.01-05.05	140/142	Fg.-Nr. 3B..2..000 001→		0 265 225 122 ^T				
4.0	05.02-09.04	202		CS2	0 265 216 564 ^B				
					0 265 220 407 ^E				
4.0, 4Motion	09.01-09.04	202			0 265 225 088 ^T				
4.0 4Motion	09.01-09.04	202		CS2	0 265 220 410 ^E				
	1.6	10.00-04.01	75	Fg.-Nr. →3B..1..400 000			0 265 109 463 ^M		
	1.8	10.00-04.01	110/125	Fg.-Nr. →3B..1..400 000			0 265 109 463 ^M		
	1.9 TDI	10.00-04.01	74	Fg.-Nr. →3B..1..400 000		0 265 109 463 ^M			
			96	Fg.-Nr. →3B..1..400 000		0 265 109 463 ^M			
	1.9 TDI 4Motion	10.00-04.01	96	Fg.-Nr. →3B..1..400 000	GRG	0 265 109 462 ^M			
	2.0	10.00-04.01	85	Fg.-Nr. →3B..1..400 000		0 265 109 463 ^M			
2.0 4Motion	10.00-04.01	85	Fg.-Nr. →3B..1..400 000	GRG	0 265 109 462 ^M				



VW Passat Variant [3B6]

2.3	10.00-04.01	125	Fg.-Nr. →3B..1..400 000		0 265 109 463 ^M
2.3 4Motion	01.01-04.01	125	Fg.-Nr. →3B..1..400 000	GRG	0 265 109 462 ^M
2.5 TDI	10.00-04.01	110	Fg.-Nr. →3B..1..400 000		0 265 109 463 ^M
2.5 TDI 4Motion	10.00-04.01	110	Fg.-Nr. →3B..1..400 000	GRG	0 265 109 462 ^M
2.8	10.00-04.01	140/142	Fg.-Nr. →3B..1..400 000		0 265 109 463 ^M
2.8 4Motion	10.00-04.01	140/142	Fg.-Nr. →3B..1..400 000	GRG	0 265 109 462 ^M

1.6	10.00-04.01	75	Fg.-Nr. →3B..1..400 000		0 265 005 214
	05.01-05.05	75	Fg.-Nr. 3B..1..400 001→		0 265 005 252
1.8	10.00-04.01	110	Fg.-Nr. →3B..1..400 000		0 265 005 214
	05.01-05.05	110	Fg.-Nr. 3B..1..400 001→		0 265 005 252
1.9 TDI	10.00-04.01	74/96	Fg.-Nr. →3B..1..400 000		0 265 005 214
1.9 TDI 4Motion	05.01-05.05	74/96	Fg.-Nr. 3B..1..400 001→		0 265 005 252
2.0	10.00-04.01	85	Fg.-Nr. →3B..1..400 000		0 265 005 214
2.0 4Motion	05.01-05.05	85	Fg.-Nr. 3B..1..400 001→		0 265 005 252
2.3	10.00-04.01	125	Fg.-Nr. →3B..1..400 000		0 265 005 214
2.3 4Motion	05.01-05.05	125	Fg.-Nr. 3B..1..400 001→		0 265 005 252
2.5 TDI	10.00-04.01	110	Fg.-Nr. →3B..1..400 000		0 265 005 214
2.5 TDI 4Motion	05.01-05.03	110	Fg.-Nr. 3B..1..400 001→		0 265 005 252
2.8	10.00-04.01	140/142	Fg.-Nr. →3B..1..400 000		0 265 005 214
2.8 4Motion	05.01-05.05	140/142	Fg.-Nr. 3B..1..400 001→		0 265 005 252
4.0 4Motion	09.01-09.04	202			0 265 005 252













1.6	10.00-05.05	75			0 265 005 303
1.8	10.00-05.05	110/125			0 265 005 303
1.9 TDI, TDI 4Motion	10.00-05.05	74/96			0 265 005 303
2.0, TDI, 4Motion	10.00-05.05	85/96/100			0 265 005 303
2.3, 4Motion	10.00-05.05	125			0 265 005 303
2.5 TDI, TDI 4Motion	10.00-05.05	110/120/132			0 265 005 303
2.8, 4Motion	10.00-05.05	140/142			0 265 005 303
4.0, 4Motion	09.01-09.04	202			0 265 005 303

Passat Variant [3C5]









1.4 TSI	05.07-11.10	90			0 986 486 554	19,05
1.4 TSI EcoFuel	11.08-11.10	110	PR-Code OEJ		0 986 486 576	19
			PR-Code OEM		0 986 486 554	19,05
1.6	08.05-11.10	75			0 986 486 554	19,05
1.6 FSI	08.05-06.08	85	PR-Code OEM		0 986 486 554	19,05
1.6 TDI	08.09-11.10	77	PR-Code OEJ		0 986 486 576	19
			PR-Code OEM		0 986 486 554	19,05
1.8 TSI	05.07-11.10	112/118	PR-Code OEJ		0 986 486 576	19
			PR-Code OEM		0 986 486 554	19,05
1.9 TDI	08.05-11.08	77	PR-Code OEJ		0 986 486 576	19
			PR-Code OEM		0 986 486 554	19,05
2.0 FSI	08.05-11.10	110	PR-Code OEJ		0 986 486 576	19
2.0 FSI 4Motion			PR-Code OEM		0 986 486 554	19,05
2.0 TDI	08.05-06.08	120			0 986 486 595	29
	11.08-11.10	81	PR-Code OEJ		0 986 486 576	19
			PR-Code OEM		0 986 486 554	19,05
2.0 TDI, TDI 4Motion	08.05-11.10	88/90/100/103/105			0 986 486 595	29
2.0 TDI, TDI 4Motion, TSI	12.07-11.10	125/147			0 986 486 554	19,05
2.0 TDI, TSI	08.05-11.10	125/147			0 986 486 595	29
3.2 FSI 4Motion	11.05-11.10	184			0 986 486 554	19,05
3.6 FSI, FSI R36 4Motion, FSI 4Motion	09.05-11.10	206/220			0 986 486 554	19,05

Passat Variant [3G5]

1.4 GTE Hybrid	05.15→	115		LLE	0 204 819 790
				RLE	0 204 819 792









		S								
Passat Variant [315/35I/3A5]										
										
	1.6	ABO	10.94-03.97	74		JBH	F 026 003 562	20,6		
							F 026 003 563	22		
		ABS	10.94-07.95	74	Fg.-Nr. →3A-S-300 000	JBH, LLE	0 986 480 878	23,8		
			08.95-03.97	74	Fg.-Nr. 3A-T-000 001→	JBH, LLE	0 986 480 987	23,81		
	1.8	ABO	08.90-03.97	55/66		JBH	F 026 003 562	20,6		
							F 026 003 563	22		
		ABS	08.90-07.95	55/66	Fg.-Nr. →3A-S-300 000	JBH, LLE	0 986 480 878	23,8		
			08.95-03.97	55/66	Fg.-Nr. 3A-T-000 001→	JBH, LLE	0 986 480 987	23,81		
	1.9 TD	ABO	03.91-03.97	55/66/81		JBH	F 026 003 562	20,6		
	1.9 TDI						F 026 003 563	22		
			ABS	03.91-07.95	55/66	Fg.-Nr. →3A-S-300 000	JBH, LLE	0 986 480 878	23,8	
			08.95-03.97	55/66	Fg.-Nr. 3A-T-000 001→	JBH, LLE	0 986 480 987	23,81		
	1.9 TDI	ABS	03.96-03.97	81	Fg.-Nr. 3A-T-000 001→	JBH, LLE	0 986 480 987	23,81		
	2.0	ABO	03.90-03.97	79/85/110		JBH	F 026 003 562	20,6		
							F 026 003 563	22		
		ABS	03.90-07.95	79/85/110	Fg.-Nr. →3A-S-300 000	JBH, LLE	0 986 480 878	23,8		
	2.0 syncro		08.95-03.97	79/85/110	Fg.-Nr. 3A-T-000 001→	JBH, LLE	0 986 480 987	23,81		
	2.8	ABO	06.91-03.97	128		JBH	F 026 003 562	20,6		
							F 026 003 563	22		
		ABS	06.91-07.95	128	Fg.-Nr. →3A-S-300 000	JBH, LLE	0 986 480 878	23,8		
			08.95-03.97	128	Fg.-Nr. 3A-T-000 001→	JBH, LLE	0 986 480 987	23,81		
	2.8 syncro	MFD	10.94-12.95	142	Fg.-Nr. →3B..X..600 000	JBH	0 986 480 974	23,8		
			OFD	10.94-12.95	142	Fg.-Nr. →3B..X..600 000	JBH	0 986 480 890	23,81	
	2.9 syncro	ABS	01.94-07.95	135	Fg.-Nr. →3A-S-300 000	JBH, LLE	0 986 480 878	23,8		
				08.95-03.97	135	Fg.-Nr. 3A-T-000 001→	JBH, LLE	0 986 480 987	23,81	
	1.6		10.94-03.97	74	Fg.-Nr. 3A..R..000 001→	LLE	0 986 486 041	19		
	1.8		01.94-03.97	66	Fg.-Nr. 3A..R..000 001→	LLE	0 986 486 041	19		
	1.9 TDI		01.94-03.97	66/81	Fg.-Nr. 3A..R..000 001→	LLE	0 986 486 041	19		
	2.0, syncro		01.94-03.97	79/85/110	Fg.-Nr. 3A..R..000 001→	LLE	0 986 486 041	19		
	2.8		01.94-03.97	128	Fg.-Nr. 3A..R..000 001→	LLE	0 986 486 041	19		
	2.8 syncro		10.94-12.95	142	Fg.-Nr. →3B..V..100 000	LLE	0 986 486 083	19		
	2.9 syncro		01.94-03.97	135	Fg.-Nr. 3A..R..000 001→	LLE	0 986 486 041	19		
	1.6		10.94-03.97	74			0 986 486 537	23,8		
	1.8		08.90-03.97	55/66			0 986 486 537	23,8		
	1.9 TD, TDI		03.91-03.97	55/66/81			0 986 486 537	23,8		
	2.0, syncro		03.90-03.97	79/85/110			0 986 486 537	23,8		
	2.8		06.91-03.97	128			0 986 486 537	23,8		
	2.8 syncro		10.94-12.95	142	Fg.-Nr. →3B..V..100 000		0 986 486 551	22,2		
	2.9 syncro		01.94-03.97	135			0 986 486 537	23,8		
	1.6		10.94-03.97	74		NIV	0 986 482 006^A			
					Fg.-Nr. 31..LE..183 282→	NIV	0 204 131 058			
	1.8		08.90-03.97	55/66			NIV	0 986 482 006^A		
					Fg.-Nr. 31..LE..183 282→	NIV	0 204 131 058			
	1.9 TD		03.91-03.97	55/66/81			NIV	0 986 482 006^A		
	1.9 TDI				Fg.-Nr. 31..LE..183 282→	NIV	0 204 131 058			
	2.0		03.90-09.94	85			NIV	0 204 131 058		
			03.90-03.97	85			NIV	0 986 482 006^A		
			01.94-03.97	110			NIV	0 986 482 006^A		
					Fg.-Nr. 31..LE..183 282→	NIV	0 204 131 058			
				10.94-03.97	79		NIV	0 986 482 006^A		
					Fg.-Nr. 31..LE..183 282→	NIV	0 204 131 058			
					85	Fg.-Nr. 31..LE..183 282→	NIV	0 204 131 058		
	2.0 syncro		10.90-03.97	85	Fg.-Nr. 31-L-000 001→	NIV	0 204 131 058			
				Fg.-Nr. 31-L-152 501→	NIV	0 986 482 006^A				
2.8		06.91-03.97	128			NIV	0 986 482 006^A			
				Fg.-Nr. 31..LE..183 282→	NIV	0 204 131 058				

◀ VW Passat Variant [315/35I/3A5]										
	2.9 syncro	01.94-03.97	135	Fg.-Nr. 31-L-000 001→	NIV	0 204 131 058				
				Fg.-Nr. 31-L-152 501→	NIV	0 986 482 006 ^A				
	2.8 syncro	10.94-12.95	142			0 265 202 403 ^M				
					CS2	0 265 220 410 ^E				
					CS2,NFN	0 265 216 564 ^B				
				Fg.-Nr. →3B..W..030 000	NFN	0 265 216 413 ^B				
	ASR	10.94-12.95	142	Fg.-Nr. →3B..W..030 000		0 265 220 446 ^E				
	EDS	10.94-12.95	142	Fg.-Nr. →3B..W..030 000		0 265 220 440 ^E				
	2.8 syncro	10.94-12.95	142		GRG	0 265 109 426 ^M				
	2.8 syncro	10.94-12.95	142		5PO	0 265 005 207				
					6PO	0 265 005 214				
Passat Variant [365]										
	1.4 TSI	08.10→	90			0 986 486 554	19,05			
	1.4 TSI, TSI EcoFuel	09.10→	110/118			0 986 486 576	19			
	1.6 TDI	08.10→	77			0 986 486 576	19			
	1.8 TSI	08.10→	112/118		PR-Code OEJ		0 986 486 576	19		
					PR-Code OEN		0 986 486 595	29		
2.0 TDI, TDI 4Motion, TSI	08.10→	100/103/125/130/155				0 986 486 595	29			
Passat [3B2]										
	1.6	MFD	10.96-04.99	74	Fg.-Nr. →3B..X..600 000	JBH	0 986 480 974	23,8		
			05.99-11.00	74	Fg.-Nr. 3B..Y..000 001→	JBH,LLE	0 986 480 966	25,4		
			07.99-11.00	74		JBH,RLE	0 986 480 989	25,4		
						JBH,LLE	0 986 480 966	25,4		
						JBH,RLE	0 986 480 989	25,4		
		OFD	10.96-04.99	74	Fg.-Nr. →3B..X..600 000	JBH	0 986 480 890	23,81		
			05.99-11.00	74	Fg.-Nr. 3B..Y..000 001→	JBH,LLE	0 986 480 935	25,4		
			07.99-11.00	74		JBH,LLE	0 986 480 935	25,4		
	1.8	MFD	12.96-01.99	92		JBH	0 986 480 974	23,8		
1.8 syncro			01.99-04.99	92	Fg.-Nr. →3B..X..600 000	JBH	0 986 480 974	23,8		
					Fg.-Nr. 3B..Y..000 001→	JBH,LLE	0 986 480 966	25,4		
			05.99-11.00	92		JBH,RLE	0 986 480 989	25,4		
		OFD	12.96-01.99	92		JBH	0 986 480 890	23,81		
			01.99-04.99	92	Fg.-Nr. →3B..X..600 000	JBH	0 986 480 890	23,81		
			05.99-11.00	92	Fg.-Nr. 3B..Y..000 001→	JBH,LLE	0 986 480 935	25,4		
	1.8	MFD	10.96-04.99	85-110	Fg.-Nr. →3B..X..600 000	JBH	0 986 480 974	23,8		
1.8 Turbo			05.99-11.00	85-110	Fg.-Nr. 3B..Y..000 001→	JBH,LLE	0 986 480 966	25,4		
						JBH,RLE	0 986 480 989	25,4		
		OFD	10.96-04.99	85-110	Fg.-Nr. →3B..X..600 000	JBH	0 986 480 890	23,81		
			05.99-11.00	85-110	Fg.-Nr. 3B..Y..000 001→	JBH,LLE	0 986 480 935	25,4		
	1.8 Turbo	MFD	08.98-04.99	110	Fg.-Nr. →3B..X..600 000	JBH	0 986 480 974	23,8		
			05.99-11.00	110	Fg.-Nr. 3B..Y..000 001→	JBH,LLE	0 986 480 966	25,4		
						JBH,RLE	0 986 480 989	25,4		
		OFD	08.98-04.99	110	Fg.-Nr. →3B..X..600 000	JBH	0 986 480 890	23,81		
			05.99-11.00	110	Fg.-Nr. 3B..Y..000 001→	JBH,LLE	0 986 480 935	25,4		
	1.9 TDI	MFD	10.96-04.99	66	Fg.-Nr. →3B..X..600 000	JBH	0 986 480 974	23,8		
			05.99-11.00	66	Fg.-Nr. 3B..Y..000 001→	JBH,LLE	0 986 480 966	25,4		
						JBH,RLE	0 986 480 989	25,4		
			02.00-11.00	74	Fg.-Nr. 3B..Y..000 001→	JBH,LLE	0 986 480 966	25,4		
						JBH,RLE	0 986 480 989	25,4		
		OFD	10.96-04.99	66	Fg.-Nr. →3B..X..600 000	JBH	0 986 480 890	23,81		
			05.99-11.00	66	Fg.-Nr. 3B..Y..000 001→	JBH,LLE	0 986 480 935	25,4		
			02.00-11.00	74	Fg.-Nr. 3B..Y..000 001→	JBH,LLE	0 986 480 935	25,4		

		S							
1.9 TDI	MFD	10.96-04.99	81/85	Fg.-Nr. →3B..X..600 000	JBH		0 986 480 974	23,8	
1.9 TDI syncro		05.99-11.00	81/85	Fg.-Nr. 3B..Y..000 001→	JBH,LLE		0 986 480 966	25,4	
					JBH,RLE		0 986 480 989	25,4	
		08.99-11.00	81/85		JBH,LLE		0 986 480 966	25,4	
					JBH,RLE		0 986 480 989	25,4	
	OFD	10.96-04.99	81/85	Fg.-Nr. →3B..X..600 000	JBH		0 986 480 890	23,81	
		05.99-11.00	81/85	Fg.-Nr. 3B..Y..000 001→	JBH,LLE		0 986 480 935	25,4	
		08.99-11.00	81/85		JBH,LLE		0 986 480 935	25,4	
2.0	MFD	01.00-08.00	88	Fg.-Nr. 3B..Y..000 001→	JBH,LLE		0 986 480 966	25,4	
					JBH,RLE		0 986 480 989	25,4	
	OFD	01.00-08.00	88	Fg.-Nr. 3B..Y..000 001→	JBH,LLE		0 986 480 935	25,4	
2.3	MFD	10.96-04.99	110	Fg.-Nr. →3B..X..600 000	JBH		0 986 480 974	23,8	
2.3 syncro		05.99-11.00	110	Fg.-Nr. 3B..Y..000 001→	JBH,LLE		0 986 480 966	25,4	
					JBH,RLE		0 986 480 989	25,4	
	OFD	10.96-04.99	110	Fg.-Nr. →3B..X..600 000	JBH		0 986 480 890	23,81	
		05.99-11.00	110	Fg.-Nr. 3B..Y..000 001→	JBH,LLE		0 986 480 935	25,4	
2.5 TDI	MFD	08.98-04.99	110	Fg.-Nr. →3B..X..600 000	JBH		0 986 480 974	23,8	
2.5 TDI syncro		05.99-11.00	110	Fg.-Nr. 3B..Y..000 001→	JBH,LLE		0 986 480 966	25,4	
					JBH,RLE		0 986 480 989	25,4	
	OFD	08.98-04.99	110	Fg.-Nr. →3B..X..600 000	JBH		0 986 480 890	23,81	
		05.99-11.00	110	Fg.-Nr. 3B..Y..000 001→	JBH,LLE		0 986 480 935	25,4	
2.8	MFD	01.97-04.99	132	Fg.-Nr. →3B..X..600 000	JBH		0 986 480 974	23,8	
		05.99-11.00	132	Fg.-Nr. 3B..Y..000 001→	JBH,LLE		0 986 480 966	25,4	
					JBH,RLE		0 986 480 989	25,4	
			142	Fg.-Nr. 3B..Y..000 001→	JBH,LLE		0 986 480 966	25,4	
					JBH,RLE		0 986 480 989	25,4	
		10.99-11.00	140		JBH,LLE		0 986 480 966	25,4	
					JBH,RLE		0 986 480 989	25,4	
	OFD	01.97-04.99	132	Fg.-Nr. →3B..X..600 000	JBH		0 986 480 890	23,81	
		05.99-11.00	132	Fg.-Nr. 3B..Y..000 001→	JBH,LLE		0 986 480 935	25,4	
			142	Fg.-Nr. 3B..Y..000 001→	JBH,LLE		0 986 480 935	25,4	
		10.99-11.00	140		JBH,LLE		0 986 480 935	25,4	
2.8	MFD	01.97-04.99	142	Fg.-Nr. →3B..X..600 000	JBH		0 986 480 974	23,8	
2.8 syncro	OFD	01.97-04.99	142	Fg.-Nr. →3B..X..600 000	JBH		0 986 480 890	23,81	
2.8 syncro	MFD	05.99-11.00	142	Fg.-Nr. 3B..Y..000 001→	JBH,LLE		0 986 480 966	25,4	
					JBH,RLE		0 986 480 989	25,4	
		10.99-11.00	142		JBH,LLE		0 986 480 966	25,4	
					JBH,RLE		0 986 480 989	25,4	
	OFD	05.99-11.00	142	Fg.-Nr. 3B..Y..000 001→	JBH,LLE		0 986 480 935	25,4	
		10.99-11.00	142		JBH,LLE		0 986 480 935	25,4	
1.6		10.96-02.97	74	Fg.-Nr. →3B..V..100 000	LLE		0 986 486 083	19	
		03.97-11.00	74	Fg.-Nr. 3B..V..100 001→	LLE		0 986 486 054	19,05	
		01.99-11.00	74		LLE		0 986 486 054	19,05	
1.8		03.97-01.99	92	Fg.-Nr. 3B..V..100 001→	LLE		0 986 486 054	19,05	
		01.99-11.00	92		LLE		0 986 486 054	19,05	
1.8		10.96-02.97	85-110	Fg.-Nr. →3B..V..100 000	LLE		0 986 486 083	19	
1.8 Turbo		03.97-11.00	85-110	Fg.-Nr. 3B..V..100 001→	LLE		0 986 486 054	19,05	
1.8 syncro		06.97-11.00	92		LLE		0 986 486 054	19,05	
1.8 Turbo		08.98-11.00	110		LLE		0 986 486 054	19,05	
1.9 TDI		10.96-06.97	66	Fg.-Nr. →3B..W..070 000	EFV,LLE		0 986 486 083	19	
			81	Fg.-Nr. →3B..W..070 000	EFV,LLE		0 986 486 083	19	
		07.97-11.00	66	Fg.-Nr. 3B..W..070 001→	LLE		0 986 486 054	19,05	
			81	Fg.-Nr. 3B..W..070 001→	LLE		0 986 486 054	19,05	
		08.97-11.00	66		LLE		0 986 486 054	19,05	
		08.99-11.00	81		LLE		0 986 486 054	19,05	
		02.00-11.00	74		LLE		0 986 486 054	19,05	
1.9 TDI syncro		06.97-11.00	81		LLE		0 986 486 054	19,05	
1.9 TDI, TDI syncro		01.98-11.00	85		LLE		0 986 486 054	19,05	
2.0		01.00-08.00	88		LLE		0 986 486 054	19,05	
2.3		10.96-02.97	110	Fg.-Nr. →3B..V..100 000	LLE		0 986 486 083	19	
		03.97-11.00	110	Fg.-Nr. 3B..V..100 001→	LLE		0 986 486 054	19,05	
2.3 syncro		06.97-11.00	110		LLE		0 986 486 054	19,05	



		S								
	◀ VW Passat [3B2]									
2.5 TDI, TDI syncro	08.98-11.00	110				LLE	0986 486 054	19,05		
2.8	01.97-02.97	132	Fg.-Nr. →3B..V..100 000			LLE	0986 486 083	19		
		142	Fg.-Nr. →3B..V..100 000			LLE	0986 486 083	19		
	03.97-11.00	132	Fg.-Nr. 3B..V..100 001→			LLE	0986 486 054	19,05		
		142	Fg.-Nr. 3B..V..100 001→			LLE	0986 486 054	19,05		
	10.97-08.00		Fg.-Nr. 3B..V..100 001→			LLE	0986 486 054	19,05		
	01.99-11.00	142				LLE	0986 486 054	19,05		
	10.99-11.00	140				LLE	0986 486 054	19,05		
2.8 syncro	01.97-11.00	142				LLE	0986 486 054	19,05		
	1.6	10.96-02.97	74	Fg.-Nr. →3B..V..100 000			0986 486 551	22,2		
		03.97-11.00	74	Fg.-Nr. 3B..V..100 001→			0986 486 548	22,2		
		01.99-11.00	74				0986 486 548	22,2		
	1.8	12.96-02.97	92	Fg.-Nr. →3B..V..100 000			0986 486 551	22,2		
		03.97-01.99	92	Fg.-Nr. 3B..V..100 001→			0986 486 548	22,2		
		01.99-11.00	92				0986 486 548	22,2		
	1.8	10.96-02.97	85-110	Fg.-Nr. →3B..V..100 000			0986 486 551	22,2		
	1.8 Turbo	03.97-11.00	85-110	Fg.-Nr. 3B..V..100 001→			0986 486 548	22,2		
	1.8 syncro	06.97-11.00	92				0986 486 548	22,2		
	1.8 Turbo	08.98-11.00	110				0986 486 548	22,2		
	1.9 TDI	10.96-06.97	66	Fg.-Nr. →3B..W..070 000			0986 486 551	22,2		
		07.97-11.00	66	Fg.-Nr. 3B..W..070 001→			0986 486 548	22,2		
		02.00-11.00	74				0986 486 548	22,2		
	1.9 TDI	10.96-06.97	81	Fg.-Nr. →3B..W..070 000			0986 486 551	22,2		
	1.9 TDI syncro	07.97-11.00	81	Fg.-Nr. 3B..W..070 001→			0986 486 548	22,2		
		01.98-11.00	85				0986 486 548	22,2		
		08.99-11.00	81				0986 486 548	22,2		
	2.0	01.00-08.00	88				0986 486 548	22,2		
	2.3	10.96-02.97	110	Fg.-Nr. →3B..V..100 000			0986 486 551	22,2		
		03.97-11.00	110	Fg.-Nr. 3B..V..100 001→			0986 486 548	22,2		
	2.3 syncro	06.97-11.00	110				0986 486 548	22,2		
	2.5 TDI, TDI syncro	08.98-11.00	110				0986 486 548	22,2		
	2.8	01.97-02.97	132	Fg.-Nr. →3B..V..100 000			0986 486 551	22,2		
			132	Fg.-Nr. 3B..V..100 001→			0986 486 548	22,2		
		03.97-11.00	142	Fg.-Nr. 3B..V..100 001→			0986 486 548	22,2		
							0986 486 548	22,2		
		10.97-08.00					0986 486 548	22,2		
01.99-11.00		142				0986 486 548	22,2			
10.99-11.00		140				0986 486 548	22,2			
2.8, syncro	01.97-02.97	142	Fg.-Nr. →3B..V..100 000			0986 486 551	22,2			
2.8 syncro	01.97-11.00	142				0986 486 548	22,2			
	1.6	10.96-05.97	74	Fg.-Nr. →3B..W..030 000			0265 220 440 ^E			
							0265 220 446 ^F			
		10.96-11.00	74				CS2	0265 202 403 ^M		
								0265 216 564 ^B		
		06.97-11.98	74	Fg.-Nr. 3B..W..030 001→ 3B..X..300 000		CS2	0265 220 413 ^F			
		06.97-11.00	74	Fg.-Nr. 3B..W..030 001→		CS2	0265 220 407 ^E			
		12.98-04.00	74	Fg.-Nr. 3B..X..300 001→ 3B..YE399 201		CS2	0265 220 527 ^F			
		01.99-04.00	74	Fg.-Nr. →3B..YE399 201		CS2	0265 220 527 ^F			
		01.99-11.00	74			CS2	0265 220 407 ^E			
		05.00-11.00	74	Fg.-Nr. 3B..YE399 202→		CS2	0265 220 639 ^F			
		1.8	12.96-05.97	92	Fg.-Nr. →3B..W..030 000			0265 220 440 ^E		
								0265 220 446 ^F		
			12.96-11.00	92			CS2	0265 216 564 ^B		
							0265 220 413 ^F			
	06.97-11.98		92	Fg.-Nr. 3B..W..030 001→ 3B..X..300 000		CS2	0265 220 413 ^F			
	06.97-01.99		92	Fg.-Nr. 3B..W..030 001→		CS2	0265 220 407 ^E			
	12.98-01.99		92	Fg.-Nr. 3B..X..300 001→		CS2	0265 220 527 ^F			
	01.99-04.00	92	Fg.-Nr. →3B..YE399 201		CS2	0265 220 527 ^F				
	01.99-11.00	92			CS2	0265 220 407 ^E				
	05.00-11.00	92	Fg.-Nr. 3B..YE399 202→		CS2	0265 220 639 ^F				

		S							
1.8, syncro		12.96-11.00	92						0 265 202 403 ^M
1.8, Turbo		10.96-05.97	85-110	Fg.-Nr. →3B..W..030 000					0 265 220 440 ^E
									0 265 220 446 ^F
		10.96-11.00	85-110						0 265 202 403 ^M
						CS2			0 265 216 564 ^B
		06.97-11.98	85-110	Fg.-Nr. 3B..W..030 001→ 3B..X..300 000		CS2			0 265 220 413 ^F
		06.97-11.00	85-110	Fg.-Nr. 3B..W..030 001→		CS2			0 265 220 407 ^E
		12.98-04.00	85-110	Fg.-Nr. 3B..X..300 001→ 3B..YE399 201		CS2			0 265 220 527 ^F
		05.00-11.00	85-110	Fg.-Nr. 3B..YE399 202→		CS2			0 265 220 639 ^F
1.8 syncro		06.97-11.00	92			CS2			0 265 220 410 ^E
1.8 Turbo		08.98-04.00	110	Fg.-Nr. →3B..YE399 201		CS2			0 265 220 527 ^F
		08.98-11.00	110						0 265 202 403 ^M
						CS2			0 265 216 564 ^B
									0 265 220 407 ^E
		05.00-11.00	110	Fg.-Nr. 3B..YE399 202→		CS2			0 265 220 639 ^F
1.9 TDI		10.96-05.97	66	Fg.-Nr. →3B..W..030 000					0 265 220 440 ^E
									0 265 220 446 ^F
			81	Fg.-Nr. →3B..W..030 000					0 265 220 440 ^E
									0 265 220 446 ^F
		10.96-11.00	66						0 265 202 403 ^M
						CS2			0 265 216 564 ^B
			81			CS2			0 265 216 564 ^B
		06.97-11.98	66	Fg.-Nr. 3B..W..030 001→ 3B..X..300 000		CS2			0 265 220 413 ^F
			81	Fg.-Nr. 3B..W..030 001→ 3B..X..300 000		CS2			0 265 220 413 ^F
		06.97-11.00	66	Fg.-Nr. 3B..W..030 001→		CS2			0 265 220 407 ^E
			81	Fg.-Nr. 3B..W..030 001→		CS2			0 265 220 407 ^E
		08.97-11.98	66	Fg.-Nr. →3B..X..300 000		CS2			0 265 220 413 ^F
		08.97-11.00	66			CS2			0 265 220 407 ^E
		01.98-04.00	85	Fg.-Nr. →3B..YE399 201		CS2			0 265 220 527 ^F
		01.98-11.00	85			CS2			0 265 216 564 ^B
									0 265 220 407 ^E
		12.98-04.00	66	Fg.-Nr. 3B..X..300 001→ 3B..YE399 201		CS2			0 265 220 527 ^F
			81	Fg.-Nr. 3B..X..300 001→ 3B..YE399 201		CS2			0 265 220 527 ^F
		08.99-04.00	81	Fg.-Nr. →3B..YE399 201		CS2			0 265 220 527 ^F
		08.99-11.00	81			CS2			0 265 220 407 ^E
		02.00-04.00	74	Fg.-Nr. →3B..YE399 201		CS2			0 265 220 527 ^F
		02.00-11.00	74						0 265 202 403 ^M
						CS2			0 265 216 564 ^B
									0 265 220 407 ^E
		05.00-11.00	66	Fg.-Nr. 3B..YE399 202→		CS2			0 265 220 639 ^F
			74	Fg.-Nr. 3B..YE399 202→		CS2			0 265 220 639 ^F
			81	Fg.-Nr. 3B..YE399 202→		CS2			0 265 220 639 ^F
			85	Fg.-Nr. 3B..YE399 202→		CS2			0 265 220 639 ^F
1.9 TDI syncro		06.97-11.00	81			CS2			0 265 220 410 ^E
		01.00-08.00	85			CS2			0 265 220 410 ^E
1.9 TDI		10.96-11.00	81						0 265 202 403 ^M
1.9 TDI syncro		01.98-11.00	85						0 265 202 403 ^M
2.0		01.00-04.00	88	Fg.-Nr. →3B..YE399 201		CS2			0 265 220 527 ^F
		01.00-08.00	88						0 265 202 403 ^M
						CS2			0 265 216 564 ^B
									0 265 220 407 ^E
		05.00-08.00	88	Fg.-Nr. 3B..YE399 202→		CS2			0 265 220 639 ^F
2.3		10.96-05.97	110	Fg.-Nr. →3B..W..030 000					0 265 220 440 ^E
									0 265 220 446 ^F
		10.96-11.00	110			CS2			0 265 216 564 ^B
		06.97-11.98	110	Fg.-Nr. 3B..W..030 001→ 3B..X..300 000		CS2			0 265 220 413 ^F



		S							
◀ VW Passat [3B2]									
2.3	06.97-11.00	110	Fg.-Nr. 3B..W..030 001→	CS2	0 265 220 407 ^E				
	12.98-04.00	110	Fg.-Nr. 3B..X..300 001→ 3B..YE399 201	CS2	0 265 220 527 ^F				
	05.00-11.00	110	Fg.-Nr. 3B..YE399 202→	CS2	0 265 220 639 ^F				
2.3, syncro	10.96-11.00	110			0 265 202 403 ^M				
2.3 syncro	06.97-11.00	110		CS2	0 265 220 410 ^E				
2.5 TDI	08.98-04.00	110	Fg.-Nr. →3B..YE399 201	CS2	0 265 220 527 ^F				
	08.98-11.00	110		CS2	0 265 216 564 ^B				
					0 265 220 407 ^E				
	05.00-11.00	110	Fg.-Nr. 3B..YE399 202→	CS2	0 265 220 639 ^F				
2.5 TDI syncro	08.98-11.00	110		CS2	0 265 220 410 ^E				
2.5 TDI, TDI syncro	08.98-11.00	110			0 265 202 403 ^M				
2.8	01.97-05.97	132	Fg.-Nr. →3B..W..030 000		0 265 220 440 ^E				
		142	Fg.-Nr. →3B..W..030 000		0 265 220 446 ^F				
					0 265 220 440 ^E				
					0 265 220 446 ^F				
	01.97-11.00	132			0 265 202 403 ^M				
					0 265 202 403 ^T				
				CS2,NFN	0 265 216 564 ^B				
				NFN	0 265 216 413 ^B				
		142		CS2	0 265 216 564 ^B				
	06.97-11.98	132	Fg.-Nr. 3B..W..030 001→ 3B..X..300 000	CS2	0 265 220 413 ^F				
		142	Fg.-Nr. 3B..W..030 001→ 3B..X..300 000	CS2	0 265 220 413 ^F				
	06.97-11.00	132	Fg.-Nr. 3B..W..030 001→	CS2	0 265 220 407 ^E				
		142	Fg.-Nr. 3B..W..030 001→	CS2	0 265 220 407 ^E				
	12.98-04.00	132	Fg.-Nr. 3B..X..300 001→ 3B..YE399 201	CS2	0 265 220 527 ^F				
		142	Fg.-Nr. 3B..X..300 001→ 3B..YE399 201	CS2	0 265 220 527 ^F				
	01.99-04.00	142	Fg.-Nr. →3B..YE399 201	CS2	0 265 220 527 ^F				
	01.99-11.00	142		CS2	0 265 220 407 ^E				
	10.99-04.00	140	Fg.-Nr. →3B..YE399 201	CS2	0 265 220 527 ^F				
	10.99-11.00	140		CS2	0 265 202 403 ^M				
					0 265 216 564 ^B				
					0 265 220 407 ^E				
	05.00-11.00	132	Fg.-Nr. 3B..YE399 202→	CS2	0 265 220 639 ^F				
		140	Fg.-Nr. 3B..YE399 202→	CS2	0 265 220 639 ^F				
		142	Fg.-Nr. 3B..YE399 202→	CS2	0 265 220 639 ^F				
2.8, syncro	01.97-11.00	142			0 265 202 403 ^M				
2.8 syncro	01.97-11.00	142		CS2	0 265 220 410 ^E				
1.6	10.96-11.00	74			0 265 109 463 ^M				
1.8	12.96-11.00	92			0 265 109 463 ^M				
1.8, Turbo	10.96-11.00	85-110			0 265 109 463 ^M				
1.8 syncro	06.97-08.99	92	Fg.-Nr. →3B..Y..100 000	GRG	0 265 109 426 ^M				
	09.99-11.00	92	Fg.-Nr. 3B..Y..100 001→	GRG	0 265 109 462 ^M				
1.8 Turbo	08.98-11.00	110			0 265 109 463 ^M				
1.9 TDI	10.96-11.00	66/74			0 265 109 463 ^M				
		81			0 265 109 463 ^M				
	01.98-11.00	85			0 265 109 463 ^M				
1.9 TDI syncro	06.97-08.99	81	Fg.-Nr. →3B..Y..100 000	GRG	0 265 109 426 ^M				
	09.99-11.00	81	Fg.-Nr. 3B..Y..100 001→	GRG	0 265 109 462 ^M				
	01.00-08.00	85		GRG	0 265 109 462 ^M				
2.0	01.00-08.00	88			0 265 109 463 ^M				
2.3	10.96-11.00	110			0 265 109 463 ^M				
2.3 syncro	06.97-08.99	110	Fg.-Nr. →3B..Y..100 000	GRG	0 265 109 426 ^M				
	09.99-11.00	110	Fg.-Nr. 3B..Y..100 001→	GRG	0 265 109 462 ^M				
2.5 TDI	08.98-11.00	110			0 265 109 463 ^M				
2.5 TDI syncro	08.98-08.99	110	Fg.-Nr. →3B..Y..100 000	GRG	0 265 109 426 ^M				
	09.99-11.00	110	Fg.-Nr. 3B..Y..100 001→	GRG	0 265 109 462 ^M				

2.8	01.97-11.00	132/140						0 265 109 463 ^M
		142						0 265 109 463 ^M
2.8 syncro	01.97-08.99	142	Fg.-Nr. →3B..Y..100 000	GRG				0 265 109 426 ^M
	09.99-11.00	142	Fg.-Nr. 3B..Y..100 001→	GRG				0 265 109 462 ^M
	10.99-11.00	142		GRG				0 265 109 462 ^M
1.6	10.96-11.00	74		5PO				0 265 005 207
				6PO				0 265 005 214
1.8, syncro, Turbo	10.96-11.00	85-110		5PO				0 265 005 207
				6PO				0 265 005 214
1.9 TDI	10.96-11.00	66		5PO				0 265 005 207
				6PO				0 265 005 214
	02.00-11.00	74						0 265 005 207
1.9 TDI	10.96-11.00	81/85		5PO				0 265 005 207
1.9 TDI syncro				6PO				0 265 005 214
2.0	01.00-08.00	88		5PO				0 265 005 207
				6PO				0 265 005 214
2.3	10.96-11.00	110		5PO				0 265 005 207
2.3 syncro				6PO				0 265 005 214
2.5 TDI	08.98-11.00	110		5PO				0 265 005 207
2.5 TDI syncro				6PO				0 265 005 214
2.8	01.97-11.00	132/140/		5PO				0 265 005 207
2.8 syncro		142		6PO				0 265 005 214

Passat [3B3]

1.6	05.01-05.05	75	Fg.-Nr. 3B..2..000 001→	JBH	LUC	0 986 481 046	25,4	
	MFD 10.00-04.01	75	Fg.-Nr. →3B..1..400 000	JBH,LLE		0 986 480 966	25,4	
				JBH,RLE		0 986 480 989	25,4	
	OFD 10.00-04.01	75	Fg.-Nr. →3B..1..400 000	JBH,LLE		0 986 480 935	25,4	
1.8	05.01-05.05	110/125	Fg.-Nr. 3B..2..000 001→	JBH	LUC	0 986 481 046	25,4	
	MFD 10.00-04.01	110/125	Fg.-Nr. →3B..1..400 000	JBH,LLE		0 986 480 966	25,4	
				JBH,RLE		0 986 480 989	25,4	
	OFD 10.00-04.01	110/125	Fg.-Nr. →3B..1..400 000	JBH,LLE		0 986 480 935	25,4	
1.9 TDI	05.01-05.05	74/96	Fg.-Nr. 3B..2..000 001→	JBH	LUC	0 986 481 046	25,4	
1.9 TDI 4Motion	MFD 10.00-04.01	74/96	Fg.-Nr. →3B..1..400 000	JBH,LLE		0 986 480 966	25,4	
				JBH,RLE		0 986 480 989	25,4	
	OFD 10.00-04.01	74/96	Fg.-Nr. →3B..1..400 000	JBH,LLE		0 986 480 935	25,4	
2.0, TDI	11.01-05.05	96/100		JBH	LUC	0 986 481 046	25,4	
2.0	05.01-05.05	85	Fg.-Nr. 3B..2..000 001→	JBH	LUC	0 986 481 046	25,4	
2.0 4Motion	MFD 10.00-04.01	85	Fg.-Nr. →3B..1..400 000	JBH,LLE		0 986 480 966	25,4	
				JBH,RLE		0 986 480 989	25,4	
	OFD 10.00-04.01	85	Fg.-Nr. →3B..1..400 000	JBH,LLE		0 986 480 935	25,4	
2.3	05.01-05.05	125	Fg.-Nr. 3B..2..000 001→	JBH	LUC	0 986 481 046	25,4	
2.3 4Motion	MFD 10.00-04.01	125	Fg.-Nr. →3B..1..400 000	JBH,LLE		0 986 480 966	25,4	
				JBH,RLE		0 986 480 989	25,4	
	OFD 10.00-04.01	125	Fg.-Nr. →3B..1..400 000	JBH,LLE		0 986 480 935	25,4	
2.5 TDI	05.01-05.03	110	Fg.-Nr. 3B..2..000 001→	JBH	LUC	0 986 481 046	25,4	
2.5 TDI 4Motion	01.03-05.05	120/132		JBH	LUC	0 986 481 046	25,4	
	MFD 10.00-04.01	110	Fg.-Nr. →3B..1..400 000	JBH,LLE		0 986 480 966	25,4	
				JBH,RLE		0 986 480 989	25,4	
	OFD 10.00-04.01	110	Fg.-Nr. →3B..1..400 000	JBH,LLE		0 986 480 935	25,4	
2.8	05.01-05.05	140/142	Fg.-Nr. 3B..2..000 001→	JBH	LUC	0 986 481 046	25,4	
2.8 4Motion	MFD 10.00-04.01	140/142	Fg.-Nr. →3B..1..400 000	JBH,LLE		0 986 480 966	25,4	
				JBH,RLE		0 986 480 989	25,4	
	OFD 10.00-04.01	140/142	Fg.-Nr. →3B..1..400 000	JBH,LLE		0 986 480 935	25,4	
4.0, 4Motion	09.01-09.04	202		JBH	LUC	0 986 481 046	25,4	
1.6	10.00-05.05	75		LLE		0 986 486 054	19,05	
1.8	10.00-05.05	110/125		LLE		0 986 486 054	19,05	
1.9 TDI	10.00-05.05	74		LLE		0 986 486 054	19,05	

◀ VW Passat [3B3]								
1.9 TDI, TDI 4Motion	10.00-05.05	96			LLE	0 986 486 061		19,05
2.0, 4Motion	10.00-05.05	85/96			LLE	0 986 486 054		19,05
2.0 TDI	11.03-05.05	100			LLE	0 986 486 061		19,05
2.3, 4Motion	10.00-05.05	125			LLE	0 986 486 054		19,05
2.5 TDI, TDI 4Motion	10.00-05.05	110/120/132			LLE	0 986 486 061		19,05
2.8, 4Motion	10.00-05.05	140/142			LLE	0 986 486 054		19,05
4.0, 4Motion	09.01-09.04	202			LLE	0 986 486 061		19,05
1.6								
	10.00-05.05	75				0 986 486 548		22,2
1.8								
	10.00-05.05	110/125				0 986 486 548		22,2
1.9 TDI, TDI 4Motion								
	10.00-05.05	74/96				0 986 486 548		22,2
2.0, TDI, 4Motion								
	10.00-05.05	85/96/100				0 986 486 548		22,2
2.3, 4Motion								
	10.00-05.05	125				0 986 486 548		22,2
2.5 TDI, TDI 4Motion								
	10.00-05.05	110/120/132				0 986 486 548		22,2
2.8, 4Motion								
	10.00-05.05	140/142				0 986 486 548		22,2
1.6								
	10.00-04.01	75	Fg.-Nr. →3B..1..400 000			0 265 202 403 ^M		
	10.00-05.05	75		CS2		0 265 216 564 ^B		
						0 265 220 407 ^E		
	05.01-05.05	75	Fg.-Nr. 3B..2..000 001→	CS2		0 265 225 125 ^T		
1.8								
	10.00-04.01	110/125	Fg.-Nr. →3B..1..400 000			0 265 202 403 ^M		
	10.00-05.05	110/125		CS2		0 265 216 564 ^B		
						0 265 220 407 ^E		
	05.01-05.05	110/125	Fg.-Nr. 3B..2..000 001→	CS2		0 265 225 125 ^T		
1.9 TDI								
	10.00-04.01	74	Fg.-Nr. →3B..1..400 000			0 265 202 403 ^M		
	10.00-05.05	74		CS2		0 265 216 564 ^B		
						0 265 220 407 ^E		
		96		CS2		0 265 216 564 ^B		
						0 265 220 407 ^E		
	05.01-05.05	74	Fg.-Nr. 3B..2..000 001→	CS2		0 265 225 125 ^T		
		96	Fg.-Nr. 3B..2..000 001→	CS2		0 265 225 125 ^T		
1.9 TDI, TDI 4Motion								
	10.00-04.01	96	Fg.-Nr. →3B..1..400 000			0 265 202 403 ^M		
1.9 TDI 4Motion								
	10.00-05.05	96		CS2		0 265 220 410 ^E		
	05.01-05.05	96	Fg.-Nr. 3B..2..000 001→			0 265 225 122 ^T		
2.0								
	10.00-04.01	85	Fg.-Nr. →3B..1..400 000			0 265 202 403 ^M		
						0 265 202 403 ^T		
	10.00-05.05	85		CS2		0 265 216 564 ^B		
						0 265 220 407 ^E		
	05.01-05.05	85	Fg.-Nr. 3B..2..000 001→	CS2		0 265 225 125 ^T		
2.0								
	11.01-05.05	96/100		CS2		0 265 216 564 ^B		
2.0 TDI								
						0 265 220 407 ^E		
						0 265 225 125 ^T		
2.0 4Motion								
	10.00-04.01	85	Fg.-Nr. →3B..1..400 000			0 265 202 403 ^M		
	10.00-05.05	85		CS2		0 265 220 410 ^E		
	05.01-05.05	85	Fg.-Nr. 3B..2..000 001→			0 265 225 122 ^T		
2.3								
	10.00-05.05	125		CS2		0 265 216 564 ^B		
						0 265 220 407 ^E		
	05.01-05.05	125	Fg.-Nr. 3B..2..000 001→	CS2		0 265 225 125 ^T		
2.3, 4Motion								
	10.00-04.01	125	Fg.-Nr. →3B..1..400 000			0 265 202 403 ^M		
2.3 4Motion								
	01.01-05.05	125		CS2		0 265 220 410 ^E		
	05.01-05.05	125	Fg.-Nr. 3B..2..000 001→			0 265 225 122 ^T		
2.5 TDI								
	10.00-05.03	110		CS2		0 265 216 564 ^B		
						0 265 220 407 ^E		
	05.01-05.03	110	Fg.-Nr. 3B..2..000 001→	CS2		0 265 225 125 ^T		
	05.03-05.05	120		CS2		0 265 216 564 ^B		
						0 265 220 407 ^E		
						0 265 225 125 ^T		
2.5 TDI, TDI 4Motion								
	10.00-04.01	110	Fg.-Nr. →3B..1..400 000			0 265 202 403 ^M		
2.5 TDI 4Motion								
	10.00-01.03	110		CS2		0 265 220 410 ^E		
	05.01-01.03	110	Fg.-Nr. 3B..2..000 001→			0 265 225 122 ^T		
	01.03-05.05	132				0 265 225 122 ^T		
				CS2		0 265 220 410 ^E		

		S								
2.8		10.00-04.01	140	Fg.-Nr. →3B..1..400 000			0 265 202 403 ^M			
							0 265 202 403 ^T			
		10.00-05.05	140/142		CS2		0 265 216 564 ^B			
							0 265 220 407 ^E			
		05.01-05.05	140	Fg.-Nr. 3B..2..000 001→	CS2		0 265 225 125 ^T			
		142	Fg.-Nr. 3B..2..000 001→	CS2		0 265 225 125 ^T				
2.8, 4Motion		10.00-04.01	142	Fg.-Nr. →3B..1..400 000			0 265 202 403 ^M			
2.8 4Motion		10.00-04.01	140	Fg.-Nr. →3B..1..400 000			0 265 202 403 ^M			
		10.00-05.05	140		CS2		0 265 220 410 ^E			
			142		CS2		0 265 220 410 ^E			
		05.01-05.05	140	Fg.-Nr. 3B..2..000 001→			0 265 225 122 ^T			
			142	Fg.-Nr. 3B..2..000 001→			0 265 225 122 ^T			
4.0		05.02-09.04	202		CS2	0 265 216 564 ^B				
						0 265 220 407 ^E				
4.0, 4Motion		09.01-09.04	202				0 265 225 088 ^T			
4.0 4Motion		09.01-09.04	202		CS2		0 265 220 410 ^E			
		10.00-04.01	75	Fg.-Nr. →3B..1..400 000			0 265 109 463 ^M			
		1.8	10.00-04.01	110/125	Fg.-Nr. →3B..1..400 000			0 265 109 463 ^M		
		1.9 TDI	10.00-04.01	74/96	Fg.-Nr. →3B..1..400 000			0 265 109 463 ^M		
		1.9 TDI 4Motion	10.00-04.01	96	Fg.-Nr. →3B..1..400 000	GRG		0 265 109 462 ^M		
		2.0	10.00-04.01	85	Fg.-Nr. →3B..1..400 000			0 265 109 463 ^M		
		2.0 4Motion	10.00-04.01	85	Fg.-Nr. →3B..1..400 000	GRG		0 265 109 462 ^M		
		2.3	10.00-04.01	125	Fg.-Nr. →3B..1..400 000			0 265 109 463 ^M		
		2.3 4Motion	01.01-04.01	125	Fg.-Nr. →3B..1..400 000	GRG		0 265 109 462 ^M		
		2.5 TDI	10.00-04.01	110	Fg.-Nr. →3B..1..400 000			0 265 109 463 ^M		
		2.5 TDI 4Motion	10.00-04.01	110	Fg.-Nr. →3B..1..400 000	GRG		0 265 109 462 ^M		
		2.8	10.00-04.01	140/142	Fg.-Nr. →3B..1..400 000			0 265 109 463 ^M		
		2.8 4Motion	10.00-04.01	140/142	Fg.-Nr. →3B..1..400 000	GRG		0 265 109 462 ^M		
				10.00-04.01	75	Fg.-Nr. →3B..1..400 000			0 265 005 214	
	05.01-05.05			75	Fg.-Nr. 3B..1..400 001→			0 265 005 252		
1.8	10.00-04.01			110/125	Fg.-Nr. →3B..1..400 000			0 265 005 214		
	05.01-05.05			110/125	Fg.-Nr. 3B..1..400 001→			0 265 005 252		
1.9 TDI	10.00-04.01			74/96	Fg.-Nr. →3B..1..400 000			0 265 005 214		
1.9 TDI 4Motion	05.01-05.05			74/96	Fg.-Nr. 3B..1..400 001→			0 265 005 252		
2.0	10.00-04.01			85	Fg.-Nr. →3B..1..400 000			0 265 005 214		
2.0 4Motion	05.01-05.05			85	Fg.-Nr. 3B..1..400 001→			0 265 005 252		
2.3	10.00-04.01			125	Fg.-Nr. →3B..1..400 000			0 265 005 214		
2.3 4Motion	05.01-05.05			125	Fg.-Nr. 3B..1..400 001→			0 265 005 252		
2.5 TDI	10.00-04.01			110	Fg.-Nr. →3B..1..400 000			0 265 005 214		
2.5 TDI 4Motion	05.01-05.03			110	Fg.-Nr. 3B..1..400 001→			0 265 005 252		
2.8	10.00-04.01			140/142	Fg.-Nr. →3B..1..400 000			0 265 005 214		
2.8 4Motion	05.01-05.05	140/142	Fg.-Nr. 3B..1..400 001→			0 265 005 252				
4.0 4Motion	09.01-09.04	202				0 265 005 252				
		10.00-05.05	75				0 265 005 303			
		1.8	10.00-05.05	110/125				0 265 005 303		
		1.9 TDI, TDI 4Motion	10.00-05.05	74/96				0 265 005 303		
		2.0, TDI, 4Motion	10.00-05.05	85/96/100				0 265 005 303		
		2.3, 4Motion	10.00-05.05	125				0 265 005 303		
		2.5 TDI, TDI 4Motion	10.00-05.05	110/120/132				0 265 005 303		
		2.8, 4Motion	10.00-05.05	140/142				0 265 005 303		
		4.0, 4Motion	09.01-09.04	202				0 265 005 303		
Passat [3C2]										
		05.07-07.10	90	PR-Code OEM			0 986 486 554	19,05		
		1.4 TSI EcoFuel	11.08-07.10	110	PR-Code OEJ			0 986 486 576	19	
					PR-Code OEM			0 986 486 554	19,05	
		1.6	03.05-07.10	75				0 986 486 554	19,05	

		S							
	◀ VW Passat [3C2]								
	1.6 FSI	03.05-06.08	85		PR-Code OEM		0 986 486 554		19,05
	1.6 TDI	08.09-07.10	77		PR-Code OEJ		0 986 486 576		19
					PR-Code OEM		0 986 486 554		19,05
	1.8 TSI	05.08-07.10	112/118		PR-Code OEJ		0 986 486 576		19
					PR-Code OEM		0 986 486 554		19,05
	1.9 TDI	03.05-11.08	77		PR-Code OEJ		0 986 486 576		19
					PR-Code OEM		0 986 486 554		19,05
	2.0 FSI	03.05-11.05	110		PR-Code OEM		0 986 486 554		19,05
		11.05-07.10	110				0 986 486 554		19,05
	2.0 FSI, FSI 4Motion	03.05-07.10	110		PR-Code OEJ		0 986 486 576		19
	2.0 FSI 4Motion	09.05-07.10	110		PR-Code OEM		0 986 486 554		19,05
	2.0 TDI	08.05-06.08	120				0 986 486 595		29
		11.08-07.10	81		PR-Code OEJ		0 986 486 576		19
					PR-Code OEM		0 986 486 554		19,05
	2.0 TDI, TDI 4Motion	03.05-11.10	88/90/100/103/105				0 986 486 595		29
	2.0 TDI, TDI 4Motion, TSI	05.08-07.10	125/147				0 986 486 554		19,05
	2.0 TDI, TSI	03.05-11.10	125/147				0 986 486 595		29
	3.6 FSI, FSI 4Motion	09.05-07.10	206				0 986 486 554		19,05
	Passat [3G2]								
	1.4 GTE Hybrid	05.15→	115			LLE	0 204 819 790		
						RLE	0 204 819 792		
	Passat [312/35I/3A2]								
	1.6	ABO	10.94-03.97	74		JBH	F 026 003 562		20,6
							F 026 003 563		22
		ABS	10.94-07.95	74	Fg.-Nr. →3A-S-300 000	JBH,LLE	0 986 480 878		23,8
			08.95-03.97	74	Fg.-Nr. 3A-T-000 001→	JBH,LLE	0 986 480 987		23,81
	1.8	ABO	08.90-03.97	55/66		JBH	F 026 003 562		20,6
							F 026 003 563		22
		ABS	08.90-07.95	55/66	Fg.-Nr. →3A-S-300 000	JBH,LLE	0 986 480 878		23,8
			08.95-03.97	55/66	Fg.-Nr. 3A-T-000 001→	JBH,LLE	0 986 480 987		23,81
	1.8 G60	ABS	09.89-08.94	118	Fg.-Nr. →3A-S-300 000	JBH,LLE	0 986 480 878		23,8
	1.9 TD	ABO	03.91-03.97	55/66/81		JBH	F 026 003 562		20,6
	1.9 TDI						F 026 003 563		22
		ABS	03.91-07.95	55/66	Fg.-Nr. →3A-S-300 000	JBH,LLE	0 986 480 878		23,8
			08.95-03.97	55/66	Fg.-Nr. 3A-T-000 001→	JBH,LLE	0 986 480 987		23,81
	1.9 TDI	ABS	03.96-03.97	81	Fg.-Nr. 3A-T-000 001→	JBH,LLE	0 986 480 987		23,81
	2.0	ABO	03.90-03.97	79/85/110		JBH	F 026 003 562		20,6
			03.90-08.97	79/85/110		JBH	F 026 003 563		22
		ABS	08.95-08.97	79/85/110	Fg.-Nr. 3A-T-000 001→	JBH,LLE	0 986 480 987		23,81
	2.0, syncro	ABS	03.90-07.95	79/85/110	Fg.-Nr. →3A-S-300 000	JBH,LLE	0 986 480 878		23,8
	2.8	ABO	06.91-03.97	128		JBH	F 026 003 562		20,6
							F 026 003 563		22
		ABS	06.91-07.95	128	Fg.-Nr. →3A-S-300 000	JBH,LLE	0 986 480 878		23,8
			08.95-03.97	128	Fg.-Nr. 3A-T-000 001→	JBH,LLE	0 986 480 987		23,81
	1.6		10.94-03.97	74	Fg.-Nr. 3A..R..000 001→	LLE	0 986 486 041		19
	1.8		01.94-03.97	66	Fg.-Nr. 3A..R..000 001→	LLE	0 986 486 041		19
	1.9 TDI		01.94-03.97	66/81	Fg.-Nr. 3A..R..000 001→	LLE	0 986 486 041		19
	2.0, syncro		01.94-03.97	79/85/110	Fg.-Nr. 3A..R..000 001→	LLE	0 986 486 041		19
	2.8		01.94-03.97	128	Fg.-Nr. 3A..R..000 001→	LLE	0 986 486 041		19
	1.6		10.94-03.97	74			0 986 486 537		23,8
	1.8, G60		09.89-03.97	55/66/118			0 986 486 537		23,8
	1.9 TD, TDI		03.91-03.97	55/66/81			0 986 486 537		23,8
	2.0, syncro		03.90-08.97	79/85/110			0 986 486 537		23,8
	2.8		06.91-03.97	128			0 986 486 537		23,8



	1.6	10.94-03.97	74		NIV	0 986 482 006 ^A	
				Fg.-Nr. 31..LE..183 282→	NIV	0 204 131 058	
	1.8	08.90-03.97	55/66		NIV	0 986 482 006 ^A	
				Fg.-Nr. 31..LE..183 282→	NIV	0 204 131 058	
	1.8 G60	09.89-08.94	118			0 986 482 006 ^A	
		08.90-08.94	118	Fg.-Nr. 31-L-000 001→	NIV	0 204 131 058	
	1.9 TD	03.91-03.97	55/66/81		NIV	0 986 482 006 ^A	
	1.9 TDI			Fg.-Nr. 31..LE..183 282→	NIV	0 204 131 058	
	2.0	03.90-09.94	85		NIV	0 204 131 058	
		03.90-03.97	85		NIV	0 986 482 006 ^A	
		01.94-03.97	110		NIV	0 986 482 006 ^A	
				Fg.-Nr. 31..LE..183 282→	NIV	0 204 131 058	
		09.94-08.97	85	Fg.-Nr. 31..LE..183 282→	NIV	0 204 131 058	
		10.94-03.97	79		NIV	0 986 482 006 ^A	
				Fg.-Nr. 31..LE..183 282→	NIV	0 204 131 058	
	ABO 09.94-08.97	85			0 986 482 006 ^A		
2.0 syncro	10.90-09.94	85	Fg.-Nr. 31-L-000 001→	NIV	0 204 131 058		
			Fg.-Nr. 31-L-152 501→	NIV	0 986 482 006 ^A		
2.8	06.91-03.97	128		NIV	0 986 482 006 ^A		
			Fg.-Nr. 31..LE..183 282→	NIV	0 204 131 058		

Passat [362]

	1.4 TSI	08.10→	90			0 986 486 554	19,05
	1.4 TSI, TSI EcoFuel	09.10→	110/118			0 986 486 576	19
	1.6 TDI	08.10→	77			0 986 486 576	19
	1.8 TSI	08.10→	112/118	PR-Code OEJ		0 986 486 576	19
				PR-Code OEN		0 986 486 595	29
	2.0 TDI, TDI 4Motion, TSI	08.10→	100/103/125/130/155			0 986 486 595	29

Phaeton [3D]

	3.2	05.02-05.05	177			0 265 225 056 ^T	
	3.0 FSI 4Motion, TDI 4Motion	09.04→	165/171/176/184			0 265 005 252	
	3.2, 4Motion	05.02-10.08	177			0 265 005 252	
	3.6 4Motion	11.08→	206			0 265 005 252	
	4.2 4Motion	05.03→	246			0 265 005 252	
	5.0 TDI 4Motion	11.02-10.06	230			0 265 005 252	
	6.0 4Motion	05.02→	309/331			0 265 005 252	
	3.0 FSI 4Motion, TDI 4Motion	09.04→	165/171/176/184			0 265 005 303	
	3.2, 4Motion	05.02-10.08	177			0 265 005 303	
	3.6 4Motion	11.08→	206			0 265 005 303	
	4.2 4Motion	05.03→	246			0 265 005 303	
	5.0 TDI 4Motion	11.02-10.06	230			0 265 005 303	
	6.0 4Motion	05.02→	309/331			0 265 005 303	

Pointer [55]









	1.8 i	05.94-12.96	72		BRB, BSY	0 204 032 350	
--	--------------	-------------	----	--	----------	---------------	--

Polo

	1.4 16V, 8V	05.02-07.06	55/61			0 265 231 436 ^B	
	1.6	05.02-07.06	74			0 265 231 436 ^B	





















			S							
◀ VW										
Polo Classic										
	1.8 Mi		07.96-05.98	73			JBH	F 026 003 562	20,6	
		ABO	01.01-12.03	66			JBH	F 026 003 563	22	
	1.9 SD	ABO	05.96-08.00	47			JBH	F 026 003 562	20,6	
			09.00-08.08	47			JBH	F 026 003 563	22	
	1.9 SD, TDI	ABS	05.96-08.08	47/66			JBH	0 986 481 016	22,2	
	1.9 TDI	ABO	03.99-08.08	66			JBH	F 026 003 563	22	
2.0 Mi		02.01-04.02	85			JBH	F 026 003 563	22		
	1.8 Mi	ABO	07.96-05.98	73				0 204 125 262		
	1.9 SD, TDI	ABO	05.96-08.08	47/66				0 204 125 262		
	1.9 SD		05.96-08.08	47			TW	0 204 131 697^A		
	1.9 TDI		03.99-08.00	66				0 204 131 697^A		
			09.00-08.08	66			TW	0 204 131 697^A		
Polo Classic [6V2]										
	1.4	ABO	05.96-05.98	44			JBH	F 026 003 562	20,6	
			12.97-07.98	44	Fg.-Nr. →6K..X..523000		JBH,RLE	F 026 003 562	20,6	
								F 026 003 563	22	
			12.97-08.99	44			JBH,LLE	F 026 003 562	20,6	
								F 026 003 563	22	
			08.98-08.99	44	Fg.-Nr. 6K..X..523 001→		RLE	0 204 123 520	20,6	
								0 204 123 521	22,22	
			10.99-09.01	44/55			JBH,LLE	F 026 003 562	20,6	
								F 026 003 563	22	
							RLE	0 204 123 520	20,6	
								0 204 123 521	22,22	
			ABS	05.96-08.99	44		JBH,LLE	0 986 480 987	23,81	
							0 986 481 016	22,2		
						JBH,RLE	0 986 480 869	22		
			10.99-09.01	44/55		JBH,LLE	0 986 480 987	23,81		
							0 986 481 016	22,2		
						JBH,RLE	0 986 480 869	22		
	1.6	ABO	11.95-09.97	55			JBH	F 026 003 562	20,6	
								F 026 003 563	22	
			12.95-07.98	74	Fg.-Nr. →6K..X..523000		JBH,RLE	F 026 003 562	20,6	
								F 026 003 563	22	
		12.95-08.99	74			JBH,LLE	F 026 003 562	20,6		
							F 026 003 563	22		
		04.97-07.98	55	Fg.-Nr. →6K..X..523000		JBH,RLE	F 026 003 562	20,6		
							F 026 003 563	22		
		04.97-09.01	55			JBH,LLE	F 026 003 562	20,6		
							F 026 003 563	22		
		08.98-08.99	74	Fg.-Nr. 6K..X..523 001→		RLE	0 204 123 520	20,6		
							0 204 123 521	22,22		
		08.98-09.01	55	Fg.-Nr. 6K..X..523 001→		RLE	0 204 123 520	20,6		
							0 204 123 521	22,22		
		10.99-09.01	74			JBH,LLE	F 026 003 562	20,6		
							F 026 003 563	22		
						RLE	0 204 123 520	20,6		
							0 204 123 521	22,22		
		ABS	11.95-09.01	55/74		JBH,LLE	0 986 480 987	23,81		
						0 986 481 016	22,2			
					JBH,RLE	0 986 480 869	22			

		S								
1.7 SDI	ABO	11.97-07.98	44	Fg.-Nr. →6K..X..523000	JBH,RLE		F 026 003 562	20,6		
							F 026 003 563	22		
		11.97-08.99	44			JBH,LLE		F 026 003 562	20,6	
								F 026 003 563	22	
		08.98-08.99	44	Fg.-Nr. 6K..X..523 001→		RLE		O 204 123 520	20,6	
								O 204 123 521	22,22	
ABS	11.97-08.99	44			JBH,LLE		O 986 480 987	23,81		
							O 986 481 016	22,2		
					JBH,RLE		O 986 480 869	22		
1.8	ABO	03.98-07.98	66	Fg.-Nr. →6K..X..523000	JBH,RLE		F 026 003 562	20,6		
							F 026 003 563	22		
		03.98-09.01	66			JBH,LLE		F 026 003 562	20,6	
								F 026 003 563	22	
		08.98-09.01	66	Fg.-Nr. 6K..X..523 001→		RLE		O 204 123 520	20,6	
								O 204 123 521	22,22	
ABS	03.98-09.01	66			JBH,LLE		O 986 480 987	23,81		
							O 986 481 016	22,2		
					JBH,RLE		O 986 480 869	22		
1.9 D	ABO	01.96-04.96	47		JBH		F 026 003 562	20,6		
							F 026 003 563	22		
1.9 D	ABS	12.95-08.99	47		JBH,LLE		O 986 480 987	23,81		
1.9 SDI							O 986 481 016	22,2		
					JBH,RLE		O 986 480 869	22		
1.9 SDI	ABO	12.95-07.98	47	Fg.-Nr. →6K..X..523000	JBH,RLE		F 026 003 562	20,6		
							F 026 003 563	22		
		12.95-08.99	47			JBH,LLE		F 026 003 562	20,6	
								F 026 003 563	22	
		08.98-08.99	47	Fg.-Nr. 6K..X..523 001→		RLE		O 204 123 520	20,6	
								O 204 123 521	22,22	
	10.99-09.01	50			JBH,LLE		F 026 003 562	20,6		
							F 026 003 563	22		
					RLE		O 204 123 520	20,6		
							O 204 123 521	22,22		
ABS	10.99-09.01	50			JBH,LLE		O 986 480 987	23,81		
							O 986 481 016	22,2		
					JBH,RLE		O 986 480 869	22		
1.9 TDI	ABO	07.96-07.98	66	Fg.-Nr. →6K..X..523000	JBH,RLE		F 026 003 562	20,6		
							F 026 003 563	22		
		07.96-08.99	66			JBH,LLE		F 026 003 562	20,6	
								F 026 003 563	22	
		08.98-08.99	66	Fg.-Nr. 6K..X..523 001→		RLE		O 204 123 520	20,6	
								O 204 123 521	22,22	
			81			JBH,LLE		F 026 003 562	20,6	
								F 026 003 563	22	
						RLE		O 204 123 520	20,6	
								O 204 123 521	22,22	
		10.99-09.01	66/81			JBH,LLE		F 026 003 562	20,6	
								F 026 003 563	22	
						RLE		O 204 123 520	20,6	
								O 204 123 521	22,22	
	ABS	07.96-08.99	66			JBH,LLE		O 986 480 987	23,81	
O 986 481 016								22,2		
					JBH,RLE		O 986 480 869	22		
	08.98-08.99	81			JBH,LLE		O 986 480 987	23,81		
							O 986 481 016	22,2		
					JBH,RLE		O 986 480 869	22		
	10.99-09.01	66/81			JBH,LLE		O 986 480 987	23,81		
							O 986 481 016	22,2		
					JBH,RLE		O 986 480 869	22		
	10.00-09.01	66	Fg.-Nr. 6K..1..517 677→		RLE		O 204 055 389			
		81	Fg.-Nr. 6K..1..517 677→		RLE		O 204 055 389			



		S									
◀ VW Polo Classic [6V2]											
2.0	ABO	08.99-09.01	85			J&H,LLE	F 026	003 562	20,6		
								F 026	003 563	22	
							RLE	0 204	123 520	20,6	
								0 204	123 521	22,22	
	ABS	08.99-09.01	85			J&H,LLE	0 986	480 987	23,81		
								0 986	481 016	22,2	
J&H,RLE							0 986	480 869	22		
1.4	ABO	05.96-08.99	44			LLE,Z9	ATE	0 204	125 262		
							RLE,Z9	ATE	0 204	125 263	
									0 204	125 264	
			10.99-09.01	44			LLE,Z9	ATE	0 204	125 262	
							RLE,Z9	ATE	0 204	125 263	
									0 204	125 264	
				55			LLE,Z9	ATE	0 204	125 262	
							RLE,Z9	ATE	0 204	125 263	
									0 204	125 264	
		ABS	05.96-08.99	44			RLE		0 204	055 380	
			10.99-09.01	44			RLE		0 204	055 380	
				55			RLE		0 204	055 380	
	1.6	ABO	11.95-09.01	55/74			LLE,Z9	ATE	0 204	125 262	
								RLE,Z9	ATE	0 204	125 263
										0 204	125 264
	ABS	11.95-09.01	55/74			RLE		0 204	055 380		
1.7 SDI	ABO	11.97-08.99	44			LLE,Z9	ATE	0 204	125 262		
							RLE,Z9	ATE	0 204	125 263	
									0 204	125 264	
	ABS	11.97-08.99	44			RLE		0 204	055 380		
1.8	ABO	03.98-09.01	66			LLE,Z9	ATE	0 204	125 262		
							RLE,Z9	ATE	0 204	125 263	
									0 204	125 264	
	ABS	03.98-09.01	66			RLE		0 204	055 380		
1.9 D	ABO	12.95-08.99	47			LLE,Z9	ATE	0 204	125 262		
							RLE,Z9	ATE	0 204	125 263	
									0 204	125 264	
1.9 SDI	ABO	10.99-09.01	50			LLE,Z9	ATE	0 204	125 262		
							RLE,Z9	ATE	0 204	125 263	
									0 204	125 264	
	ABS	12.95-08.99	47			RLE		0 204	055 380		
1.9 SDI	ABO	10.99-09.01	50			LLE,Z9	ATE	0 204	125 262		
							RLE,Z9	ATE	0 204	125 263	
									0 204	125 264	
		ABS	10.99-09.01	50			RLE		0 204	055 380	
	1.9 TDI	ABO	07.96-08.99	66			LLE,Z9	ATE	0 204	125 262	
								RLE,Z9	ATE	0 204	125 263
										0 204	125 264
				08.98-08.99	81			LLE,Z9	ATE	0 204	125 262
								RLE,Z9	ATE	0 204	125 263
										0 204	125 264
				10.99-09.01	66			LLE,Z9	ATE	0 204	125 262
								RLE,Z9	ATE	0 204	125 263
										0 204	125 264
				81			LLE,Z9	ATE	0 204	125 262	
							RLE,Z9	ATE	0 204	125 263	
									0 204	125 264	
		ABS	07.96-08.99	66			RLE		0 204	055 380	
			08.98-08.99	81			RLE		0 204	055 380	
			10.99-09.01	66			RLE		0 204	055 380	
			81			RLE		0 204	055 380		
2.0	ABO	08.99-09.01	85			LLE,Z9	ATE	0 204	125 262		
							RLE,Z9	ATE	0 204	125 263	
									0 204	125 264	
	ABS	08.99-09.01	85			RLE		0 204	055 380		

		S								
	1.6	10.99-09.01	74			LLE	0 986 486 109	15,8		
	1.7 SDI	11.97-04.99	44			LLE	0 986 486 146	15,87		
	1.9 SDI	12.95-04.99	47			LLE	0 986 486 146	15,87		
		10.99-09.01	50			LLE	0 986 486 109	15,8		
	1.9 TDI	07.96-04.99	66/81			LLE	0 986 486 038	19		
		10.99-09.01	66/81			LLE	0 986 486 109	15,8		
	1.6	10.99-09.01	74				0 986 486 542	23,81		
	1.9 SDI	10.99-09.01	50				0 986 486 542	23,81		
	1.9 TDI	07.96-08.99	66/81					0 986 486 537	23,8	
10.99-09.01		66/81					0 986 486 576	19		
	1.4	05.96-08.99	44				0 204 131 697 ^A			
		10.99-09.01	44				0 204 131 697 ^A			
			55				0 204 131 697 ^A			
	1.6	11.95-09.01	55/74				0 204 131 697 ^A			
	1.7 SDI	11.97-08.99	44				0 204 131 697 ^A			
	1.8	03.98-09.01	66				0 204 131 697 ^A			
	1.9 D, SDI	12.95-08.99	47				0 204 131 697 ^A			
	1.9 SDI	10.99-09.01	50				0 204 131 697 ^A			
	2.0	08.99-09.01	85				0 204 131 697 ^A			
	Polo Classic [9V8]									
										
	1.6 i	12.94-10.03	74			JBH	F 026 003 563	22		
	1.6 i	12.94-10.03	74				0 204 131 697 ^A			
	Polo Classic [9V8 2C4]									
										
	1.4 i	12.94-10.03	62			JBH	F 026 003 562	20,6		
		12.94-10.03	62				0 204 125 264			
	1.4 i	12.94-10.03	62				0 204 131 697 ^A			
	Polo Classic [80]									
										
		1.0	10.90-09.94	33			JBH	F 026 003 180	20,6	
								0 986 480 422	17,46	
		1.3	10.90-09.94	40/56-59			JBH	F 026 003 180	20,6	
							0 986 480 422	17,46		
RLE							0 204 123 329	19		
1.4 D		10.90-09.94	35			JBH	F 026 003 180	20,6		
							0 986 480 422	17,46		
						RLE	0 204 123 329	19		
		1.0	10.90-09.94	33			LLE	0 204 125 054		
	1.3	10.90-09.94	40			LLE	0 204 125 054			













◀ VW Polo Classic [80]									
	1.0		10.90-09.94	33				0 986 482 006 ^A	
	1.3		10.90-09.94	40/56-59				0 986 482 006 ^A	
	1.4D		10.90-09.94	35				0 986 482 006 ^A	
Polo Coupé [80]									
	1.0		10.90-09.94	33		JBH	F 026 003 180	20,6	
					RLE	0 204 123 329	19		
	1.3		10.90-09.94	40/56-59		JBH	F 026 003 180	20,6	
					RLE	0 204 123 329	19		
	1.3 G40		10.90-09.94	85		JBH	F 026 003 180	20,6	
					RLE	0 204 123 329	19		
	1.4D		10.90-09.94	35		JBH	F 026 003 180	20,6	
					RLE	0 204 123 329	19		
		1.0		10.90-09.94	33		LLE	0 204 125 054	
		1.3		10.90-09.94	40		LLE	0 204 125 054	
		1.0		10.90-09.94	33			0 986 482 006 ^A	
		1.3, G40		10.90-09.94	40/56-59/85			0 986 482 006 ^A	
1.4D			10.90-09.94	35			0 986 482 006 ^A		
Polo Hatchback									
	1.4 i		01.01-07.08	55		JBH	0 986 480 820	20,6	
Polo Limousine [9N2]									
	1.6	ABS	07.03-05.07	74	PR-Code 1CK	JBH	0 986 480 820	20,6	
	1.6		07.03-05.07	74	PR-Code OEM		0 986 486 554	19,05	
	1.6		07.03-07.04	74	Fg.-Nr. →N..40005 7000		0 265 225 162 ^T		
			08.04-09.05	74	Fg.-Nr. 9N..50000 001→, 9N..5P000 001→9N..6P005 843		0 265 231 436 ^B		
			08.04-05.07	74	Fg.-Nr. 9N..50000 001→		0 265 234 703 ^T		
			10.05-05.07	74	Fg.-Nr. 9N..6P005 844→		0 265 232 246 ^B		
	1.6		07.03-05.07	74		TW	0 265 005 252		
						0 265 005 692			
Polo Playa [9V4]									
	1.4 i		10.98-10.02	62		JBH	F 026 003 562	20,6	
	1.6 i		10.98-10.02	74		JBH	F 026 003 563	22	
	1.8 i	ABO	10.98-10.02	82		JBH	F 026 003 563	22	
	1.4 i		10.98-10.02	62			0 204 125 264		

Polo Sedan									
	1.4 16V	11.02-02.05	55				0 265 231 436 ^B		
	1.9 TDI	11.02-07.06	74				0 265 231 436 ^B		
Polo Sedan [612]									
	1.6	09.10→	63/77				0 986 486 554	19,05	
Polo Sedan [614]									
	1.6	05.15→	63/77				0 986 486 554	19,05	
Polo Variant [6V5]									
	1.4	ABO 05.97-12.97	44			JBH	F 026 003 562	20,6	
							F 026 003 563	22	
		12.97-07.98	44	Fg.-Nr. →6K..X..523000		JBH,RLE	F 026 003 562	20,6	
							F 026 003 563	22	
		12.97-08.99	44			JBH,LLE	F 026 003 562	20,6	
							F 026 003 563	22	
		08.98-08.99	44	Fg.-Nr. 6K..X..523 001→		RLE	0 204 123 520	20,6	
							0 204 123 521	22,22	
		10.99-09.01	44/55			JBH,LLE	F 026 003 562	20,6	
							F 026 003 563	22	
						RLE	0 204 123 520	20,6	
							0 204 123 521	22,22	
		ABS 05.97-08.99	44			JBH,LLE	0 986 480 987	23,81	
							0 986 481 016	22,2	
						JBH,RLE	0 986 480 869	22	
		10.99-09.01	44/55			JBH,LLE	0 986 480 987	23,81	
							0 986 481 016	22,2	
						JBH,RLE	0 986 480 869	22	
	1.6	ABO 05.97-07.98	74	Fg.-Nr. →6K..X..523000		JBH,RLE	F 026 003 562	20,6	
							F 026 003 563	22	
		05.97-08.99	74			JBH,LLE	F 026 003 562	20,6	
							F 026 003 563	22	
		09.97-07.98	55	Fg.-Nr. →6K..X..523000		JBH,RLE	F 026 003 562	20,6	
							F 026 003 563	22	
		09.97-09.01	55			JBH,LLE	F 026 003 562	20,6	
							F 026 003 563	22	
		08.98-08.99	74	Fg.-Nr. 6K..X..523 001→		RLE	0 204 123 520	20,6	
							0 204 123 521	22,22	
		08.98-09.01	55	Fg.-Nr. 6K..X..523 001→		RLE	0 204 123 520	20,6	
							0 204 123 521	22,22	
		10.99-09.01	74			JBH,LLE	F 026 003 562	20,6	
							F 026 003 563	22	
						RLE	0 204 123 520	20,6	
							0 204 123 521	22,22	
		ABS 05.97-09.01	55/74			JBH,LLE	0 986 480 987	23,81	
							0 986 481 016	22,2	
						JBH,RLE	0 986 480 869	22	



		S								
◀ VW Polo Variant [6V5]										
1.7 SDI	ABO	11.97-07.98	44	Fg.-Nr. →6K..X..523000	JBH,RLE	F 026 003 562	20,6			
						F 026 003 563	22			
			11.97-08.99	44		JBH,LLE	F 026 003 562	20,6		
							F 026 003 563	22		
			08.98-08.99	44	Fg.-Nr. 6K..X..523 001→	RLE	0 204 123 520	20,6		
							0 204 123 521	22,22		
		ABS	11.97-08.99	44		JBH,LLE	0 986 480 987	23,81		
							0 986 481 016	22,2		
						JBH,RLE	0 986 480 869	22		
	1.9 SDI	ABO	06.97-07.98	47	Fg.-Nr. →6K..X..523000	JBH,RLE	F 026 003 562	20,6		
F 026 003 563							22			
			06.97-08.99	47		JBH,LLE	F 026 003 562	20,6		
							F 026 003 563	22		
			08.98-08.99	47	Fg.-Nr. 6K..X..523 001→	RLE	0 204 123 520	20,6		
							0 204 123 521	22,22		
			10.99-09.01	50		JBH,LLE	F 026 003 562	20,6		
							F 026 003 563	22		
						RLE	0 204 123 520	20,6		
							0 204 123 521	22,22		
		ABS	06.97-08.99	47		JBH,LLE	0 986 480 987	23,81		
							0 986 481 016	22,2		
						JBH,RLE	0 986 480 869	22		
			10.99-09.01	50		JBH,LLE	0 986 480 987	23,81		
						0 986 481 016	22,2			
					JBH,RLE	0 986 480 869	22			
1.9 TDI	ABO	06.97-07.98	66	Fg.-Nr. →6K..X..523000	JBH,RLE	F 026 003 562	20,6			
						F 026 003 563	22			
			06.97-08.99	66		JBH,LLE	F 026 003 562	20,6		
							F 026 003 563	22		
			06.98-07.98	81	Fg.-Nr. →6K..X..523000	JBH,RLE	F 026 003 562	20,6		
							F 026 003 563	22		
			06.98-08.99	81		JBH,LLE	F 026 003 562	20,6		
							F 026 003 563	22		
			08.98-08.99	66	Fg.-Nr. 6K..X..523 001→	RLE	0 204 123 520	20,6		
							0 204 123 521	22,22		
				81	Fg.-Nr. 6K..X..523 001→	RLE	0 204 123 520	20,6		
							0 204 123 521	22,22		
			10.99-09.01	66		JBH,LLE	F 026 003 562	20,6		
							F 026 003 563	22		
						RLE	0 204 123 520	20,6		
							0 204 123 521	22,22		
				81		JBH,LLE	F 026 003 562	20,6		
							F 026 003 563	22		
						RLE	0 204 123 520	20,6		
							0 204 123 521	22,22		
		ABS	06.97-08.99	66		JBH,LLE	0 986 480 987	23,81		
							0 986 481 016	22,2		
					JBH,RLE	0 986 480 869	22			
		06.98-08.99	81		JBH,LLE	0 986 480 987	23,81			
						0 986 481 016	22,2			
					JBH,RLE	0 986 480 869	22			
		10.99-09.01	66		JBH,LLE	0 986 480 987	23,81			
						0 986 481 016	22,2			
					JBH,RLE	0 986 480 869	22			
			81		JBH,LLE	0 986 480 987	23,81			
						0 986 481 016	22,2			
					JBH,RLE	0 986 480 869	22			
		10.00-09.01	66	Fg.-Nr. 6K..1..517 677→	RLE	0 204 055 389				
			81	Fg.-Nr. 6K..1..517 677→	RLE	0 204 055 389				













		S								
	1.4	ABO	05.97-08.99	44			LLE,Z9 ATE	0 204 125 262		
							RLE,Z9 ATE	0 204 125 263		
								0 204 125 264		
				10.99-09.01	44			LLE,Z9 ATE	0 204 125 262	
								RLE,Z9 ATE	0 204 125 263	
									0 204 125 264	
					55			LLE,Z9 ATE	0 204 125 262	
								RLE,Z9 ATE	0 204 125 263	
									0 204 125 264	
			ABS	05.97-08.99	44			RLE	0 204 055 380	
				10.99-09.01	44			RLE	0 204 055 380	
					55			RLE	0 204 055 380	
1.6	ABO	05.97-09.01	55/74				LLE,Z9 ATE	0 204 125 262		
							RLE,Z9 ATE	0 204 125 263		
								0 204 125 264		
		ABS	05.97-09.01	55/74			RLE	0 204 055 380		
1.7 SDI	ABO	11.97-08.99	44				LLE,Z9 ATE	0 204 125 262		
							RLE,Z9 ATE	0 204 125 263		
								0 204 125 264		
		ABS	11.97-08.99	44			RLE	0 204 055 380		
1.9 SDI	ABO	06.97-08.99	47				LLE,Z9 ATE	0 204 125 262		
							RLE,Z9 ATE	0 204 125 263		
								0 204 125 264		
			10.99-09.01	50			LLE,Z9 ATE	0 204 125 262		
							RLE,Z9 ATE	0 204 125 263		
								0 204 125 264		
		ABS	06.97-08.99	47			RLE	0 204 055 380		
			10.99-09.01	50			RLE	0 204 055 380		
1.9 TDI	ABO	06.97-08.99	66				LLE,Z9 ATE	0 204 125 262		
							RLE,Z9 ATE	0 204 125 263		
								0 204 125 264		
				06.98-08.99	81			LLE,Z9 ATE	0 204 125 262	
								RLE,Z9 ATE	0 204 125 263	
									0 204 125 264	
				10.99-09.01	66			LLE,Z9 ATE	0 204 125 262	
								RLE,Z9 ATE	0 204 125 263	
									0 204 125 264	
				81				LLE,Z9 ATE	0 204 125 262	
								RLE,Z9 ATE	0 204 125 263	
									0 204 125 264	
		ABS	06.97-08.99	66			RLE	0 204 055 380		
			06.98-08.99	81			RLE	0 204 055 380		
			10.99-09.01	66			RLE	0 204 055 380		
				81			RLE	0 204 055 380		
	1.6		10.99-09.01	74			LLE	0 986 486 109	15,8	
	1.7 SDI		11.97-04.99	44			LLE	0 986 486 146	15,87	
	1.9 SDI		06.97-04.99	47				LLE	0 986 486 146	15,87
			10.99-09.01	50				LLE	0 986 486 109	15,8
1.9 TDI		06.97-04.99	66/81				LLE	0 986 486 038	19	
		10.99-09.01	66/81				LLE	0 986 486 109	15,8	
	1.6		10.99-09.01	74				0 986 486 542	23,81	
	1.9 SDI		10.99-09.01	50				0 986 486 542	23,81	
	1.9 TDI		06.97-08.99	66/81					0 986 486 537	23,8
			10.99-09.01	66/81					0 986 486 576	19
	1.4		05.97-08.99	44				0 204 131 697 ^A		
			10.99-09.01	44				0 204 131 697 ^A		
				55				0 204 131 697 ^A		
	1.6		05.97-09.01	55/74				0 204 131 697 ^A		
1.7 SDI		11.97-08.99	44				0 204 131 697 ^A			















		S							
VW Polo Variant [6V5]									
1.9 SDI		06.97-08.99	47					0 204 131 697 ^A	
		10.99-09.01	50					0 204 131 697 ^A	
Polo Vivo [6S1]									
	1.4 i	ABO	02.10-10.11	55/63				0 986 480 850	20,6
		ABS	02.10-10.11	55/63				0 986 480 820	20,6
	1.4 i		02.10→	55/63				0 986 486 554	19,05
	1.4 i		02.10→	55/63				0 265 232 246 ^B	
Polo [6C1]									
	1.0 TSI		11.14→	70/81				0 986 486 554	19,05
	1.2		02.14→	66/81				0 986 486 554	19,05
	1.4 TSI ACT		04.14→	110				0 986 486 595	29
Polo [6N1]									
	1.0		10.94-04.96	33/37	Fg.-Nr. →6N-T 250 000	JBH,LLE		0 986 480 869	22
			10.94-12.99	33/37		JBH		F 026 003 562	20,6
						JBH,RLE		0 986 480 869	22
			05.96-12.99	33/37	Fg.-Nr. 6N-V 000 001→	JBH,LLE		0 986 481 013	22,2
								0 986 481 015	23,81
1.3			10.94-07.95	40		JBH		F 026 003 562	20,6
						JBH,RLE		0 986 480 869	22
					Fg.-Nr. →6N-T 250 000	JBH,LLE		0 986 480 869	22
			07.96-12.99	40		JBH		F 026 003 562	20,6
						JBH,RLE		0 986 480 869	22
					Fg.-Nr. 6N-V 000 001→	JBH,LLE		0 986 481 013	22,2
								0 986 481 015	23,81
1.4			07.95-04.96	40-44	Fg.-Nr. →6N-T 250 000	JBH,LLE		0 986 480 869	22
			07.95-12.99	40-44		JBH		F 026 003 562	20,6
						JBH,RLE		0 986 480 869	22
			04.96-04.96	74	Fg.-Nr. →6N-T 250 000	JBH,LLE		0 986 480 869	22
			04.96-12.99	74		JBH,RLE		0 986 480 869	22
			05.96-12.99	40-44	Fg.-Nr. 6N-V 000 001→	JBH,LLE		0 986 481 013	22,2
								0 986 481 015	23,81
				74	Fg.-Nr. 6N-V 000 001→	JBH,LLE		0 986 481 013	22,2
								0 986 481 015	23,81
			05.97-12.99	44		JBH		F 026 003 562	20,6
						JBH,RLE		0 986 480 869	22
					Fg.-Nr. 6N-V 000 001→	JBH,LLE		0 986 481 013	22,2
								0 986 481 015	23,81
1.6			10.94-12.99	55		JBH		F 026 003 562	20,6
			07.95-04.96	55	Fg.-Nr. →6N-T 250 000	JBH,LLE		0 986 480 869	22
			07.95-12.99	55		JBH,RLE		0 986 480 869	22
			05.96-12.99	55	Fg.-Nr. 6N-V 000 001→	JBH,LLE		0 986 481 013	22,2
								0 986 481 015	23,81
			04.98-12.99	88		JBH,RLE		0 986 480 869	22
1.7 SDI			04.97-12.99	42/44		JBH		F 026 003 562	20,6
						JBH,RLE		0 986 480 869	22
					Fg.-Nr. 6N-V 000 001→	JBH,LLE		0 986 481 013	22,2
							0 986 481 015	23,81	



		S								
1.9 D		10.94-04.96	47	Fg.-Nr. →6N-T 250 000		JBH,LLE	0 986 480 869	22		
		10.94-12.99	47			JBH	F 026 003 562	20,6		
						JBH,RLE	0 986 480 869	22		
		05.96-12.99	47	Fg.-Nr. 6N-V 000 001→		JBH,LLE	0 986 481 013	22,2		
							0 986 481 015	23,81		
 1.0		10.94-12.99	33/37			LLE	0 204 125 254			
	ABS	10.94-12.99	33/37			LLE	0 204 125 516			
1.3		10.94-07.95	40			LLE	0 204 125 254			
		07.96-12.99	40			LLE	0 204 125 254			
	ABS	10.94-07.95	40			LLE	0 204 125 516			
		07.96-12.99	40			LLE	0 204 125 516			
1.4		07.95-12.99	40-44/74			LLE	0 204 125 254			
	ABS	07.95-12.99	40-44/74			LLE	0 204 125 516			
1.6		10.94-07.95	55			RLE	0 204 125 516			
		10.94-12.99	55			LLE	0 204 125 254			
	ABO, OFD	04.98-12.99	88			RLE	0 204 125 516			
	ABS	07.95-12.99	55			LLE	0 204 125 516			
	OFD	04.98-12.99	88			LLE	0 204 125 254			
1.7 SDI		04.97-12.99	42/44			LLE	0 204 125 254			
	ABS	04.97-12.99	42/44			LLE	0 204 125 516			
1.9 D		10.94-12.99	47			LLE	0 204 125 254			
	ABS	10.94-12.99	47			LLE	0 204 125 516			
 1.0		10.94-04.99	33/37				0 986 482 007 ^A			
	1.3		10.94-07.95	40				0 986 482 007 ^A		
			07.96-04.99	40				0 986 482 007 ^A		
	1.4		07.95-04.99	40-44/74			0 986 482 007 ^A			
	1.6		10.94-04.99	55/88			0 986 482 007 ^A			
	1.7 SDI		04.97-04.99	42/44			0 986 482 007 ^A			
	1.9 D		10.94-04.99	47			0 986 482 007 ^A			
	Polo [6N2]									
 1.0		ABO 07.98-09.01	37			JBH,LLE	F 026 003 562	20,6		
	ABS	07.98-09.01	37			JBH,LLE	0 986 481 013	22,2		
						JBH,RLE	0 986 480 869	22		
	1.4	ABO	09.98-09.01	40/44			JBH,LLE	F 026 003 562	20,6	
		ABS	09.98-09.01	40/44			JBH,LLE	0 986 481 013	22,2	
							JBH,RLE	0 986 480 869	22	
	1.4 TDI	ABO	10.99-09.01	55			JBH	0 986 480 869	22	
		ABS	10.99-09.01	55			JBH,LLE	0 986 481 015	23,81	
	1.4 16V		09.98-09.01	74			JBH,RLE	0 986 480 869	22	
			01.99-09.01	55			JBH,RLE	0 986 480 869	22	
		ABO	01.99-09.01	55			JBH,LLE	F 026 003 562	20,6	
			07.99-09.01	74	PR-Code 1AG		JBH,LLE	0 986 480 869	22	
					PR-Code 1AL		JBH,LLE	F 026 003 562	20,6	
					PR-Code 1AL, PR-Code 1LX, PR-Code 1ZE, PR-Code 1ZK, PR-Code 1ZJ		JBH,RLE	0 986 480 869	22	
			10.99-09.01	55			JBH	0 986 480 869	22	
				74			JBH,RLE	0 986 480 869	22	
		ABS	09.98-09.01	74			JBH,LLE	0 986 481 015	23,81	
			01.99-09.01	55			JBH,LLE	0 986 481 013	22,2	
		07.99-09.01	74	PR-Code 1AC, PR-Code 1AH, PR-Code 1ZN, PR-Code 1LB, PR-Code 1LM, PR-Code 1ZC PR-Code 1AH, PR-Code 1AC		JBH,LLE	0 986 481 013	22,2		
	1.6	ABO	11.99-09.01	92			JBH,RLE	0 986 480 869	22	
ABS		11.99-09.01	92			JBH,LLE	0 986 481 015	23,81		



		S							
VW Polo [6N2]									
	1.7 SDI	ABO	10.99-09.01	42/44		JBH,LLE	F 026	003 562	20,6
		ABS	10.99-09.01	42/44		JBH,LLE	0986	481 013	22,2
						JBH,RLE	0986	480 869	22
	1.9 D	ABO	10.99-09.01	47		JBH,LLE	F 026	003 562	20,6
	1.9 SDI	ABO	10.99-09.01	47		JBH,LLE	0986	481 013	22,2
		ABS	10.99-09.01	47		JBH,RLE	0986	480 869	22
1.0									
	1.0	ABO	07.98-09.01	37		LLE	0204	125 254	
		OFD	07.98-09.01	37		RLE	0204	125 516	
	1.4, TDI, 16V	OFD	09.98-09.01	40/44/55/66		RLE	0204	125 516	
	1.4, 16V	ABO	09.98-09.01	40/44/55		LLE	0204	125 254	
	1.4 16V		07.99-09.01	74		RLE	0204	125 516	
		OFD	09.98-09.01	74		RLE	0204	125 516	
			07.99-09.01	74		LLE	0204	125 254	
	1.6	OFD	11.99-09.01	92		RLE	0204	125 516	
	1.7 SDI	ABO	10.99-09.01	42/44		LLE	0204	125 254	
		OFD	10.99-09.01	42/44		RLE	0204	125 516	
	1.9 D	ABO	10.99-09.01	47		LLE	0204	125 254	
	1.9 SDI	OFD	10.99-09.01	47		RLE	0204	125 516	
	1.4 16V		01.01-09.01	55			0986	486 060	15,87
	1.4 TDI		10.99-09.01	55			0986	486 576	19
Polo [6R1]									
	1.2, TDI, TSI		06.09-02.14	44/51/55/63/66/77			0986	486 554	19,05
		1.4	06.09-02.14	63			0986	486 554	19,05
			02.10→	63	PR-Code OEJ		0986	486 553	19,05
					PR-Code OEM		0986	486 554	19,05
	1.4 BiFuel		03.10-01.11	60			0986	486 554	19,05
	1.4 TSI ACT		10.12-02.14	103			0986	486 595	29
	1.6 BiFuel		01.11-02.14	60			0986	486 554	19,05
	1.6 TDI		06.09-02.14	55			0986	486 553	19,05
				66			0986	486 553	19,05
				77			0986	486 553	19,05
			02.10→	77	PR-Code OEJ		0986	486 553	19,05
					PR-Code OEM		0986	486 554	19,05
	2.0 WRC		08.13-02.14	162			0986	486 595	29
Polo [9N1]									
	1.2	ABO	11.01-05.05	40/47		JBH,LH	0986	480 850	20,6
		ABS	11.01-05.05	40/47		JBH,LH	0986	480 820	20,6
	1.4	ABO	09.01-04.05	74		JBH,LH	0986	480 850	20,6
		ABS	09.01-04.05	74		JBH,LH	0986	480 820	20,6
	1.4	ABO	09.01-06.05	55		JBH,LH	0986	480 850	20,6
	1.4 TDI	ABS	09.01-06.05	55		JBH,LH	0986	480 820	20,6
	1.4 FSI	ABO	09.01-05.05	63		JBH	0986	480 850	20,6
		ABS	09.01-05.05	63		JBH	0986	480 820	20,6
	1.9 SDI	ABO	09.01-05.05	47/74/96		JBH,LH	0986	480 850	20,6
	1.9 TDI	ABS	09.01-05.05	47/74/96		JBH,LH	0986	480 820	20,6
	1.2		11.01-05.05	40/47	PR-Code OEJ		0986	486 553	19,05
					PR-Code OEM		0986	486 554	19,05
		1.4, FSI, TDI	09.01-06.05	55/63/74	PR-Code OEJ		0986	486 553	19,05
					PR-Code OEM		0986	486 554	19,05

		S							
1.9 SDI		09.01-05.05	47/74/96	PR-Code OEJ			0 986 486 553	19,05	
1.9 TDI				PR-Code OEM			0 986 486 554	19,05	
	1.2	11.01-05.05	40/47				0 204 031 681 ^A		
	1.4, FSI, TDI	09.01-06.05	55/63/74				0 204 031 681 ^A		
						252,288	0 204 031 682 ^A		
	1.9 SDI	09.01-05.05	47/74/96				0 204 031 681 ^A		
	1.9 TDI					252,288	0 204 031 682 ^A		
	1.2	11.01-04.04	40/47	Fg.-Nr. →9N..4..233 000			0 265 225 162 ^T		
		05.04-05.05	40/47				0 265 231 436 ^B		
							0 265 232 252 ^F		
							0 265 234 119 ^T		
	1.4	09.01-01.02	55				0 265 225 162 ^T		
		09.01-04.04	55	Fg.-Nr. →9N..4..233 000			0 265 225 162 ^T		
			74	Fg.-Nr. →9N..4..233 000			0 265 225 162 ^T		
		11.01-04.02	74				0 265 225 162 ^T		
		05.04-04.05	74	Fg.-Nr. 9N..4..233 001→			0 265 232 252 ^F		
							0 265 234 119 ^T		
		05.04-05.05	55				0 265 231 436 ^B		
							0 265 232 252 ^F		
							0 265 234 119 ^T		
	1.4 FSI	09.01-04.04	63	Fg.-Nr. →9N..4..233 000			0 265 225 162 ^T		
		05.04-05.05	63	Fg.-Nr. 9N..4..233 001→			0 265 231 436 ^B		
							0 265 232 252 ^F		
							0 265 234 119 ^T		
	1.4 TDI	09.01-04.04	55	Fg.-Nr. →9N..4..233 000			0 265 225 162 ^T		
		05.04-06.05	55	Fg.-Nr. 9N..4..233 001→			0 265 231 436 ^B		
							0 265 232 252 ^F		
							0 265 234 119 ^T		
	1.9 SDI	09.01-04.04	47/74	Fg.-Nr. →9N..4..233 000			0 265 225 162 ^T		
	1.9 TDI	05.04-05.05	47/74	Fg.-Nr. 9N..4..233 001→			0 265 231 436 ^B		
							0 265 232 252 ^F		
							0 265 234 119 ^T		
	1.9 TDI	11.03-04.04	96	Fg.-Nr. →9N..4..233 000			0 265 225 162 ^T		
		05.04-05.05	96				0 265 231 436 ^B		
							0 265 232 252 ^F		
							0 265 234 119 ^T		
	1.2	11.01-04.04	40/47	Fg.-Nr. →9N..4..250 000			0 265 005 252		
		05.04-05.05	40/47				0 265 005 692		
	1.4	09.01-01.02	55				0 265 005 252		
		09.01-04.04	55	Fg.-Nr. →9N..4..250 000			0 265 005 252		
			74	Fg.-Nr. →9N..4..250 000			0 265 005 252		
		11.01-04.02	74				0 265 005 252		
		05.04-04.05	74	Fg.-Nr. 9N..5..000 001→			0 265 005 692		
		05.04-05.05	55				0 265 005 692		
	1.4 FSI	09.01-04.04	63	Fg.-Nr. →9N..4..250 000			0 265 005 252		
		05.04-05.05	63	Fg.-Nr. 9N..5..000 001→			0 265 005 692		
	1.4 TDI	09.01-04.04	55	Fg.-Nr. →9N..4..250 000			0 265 005 252		
		05.04-06.05	55	Fg.-Nr. 9N..5..000 001→			0 265 005 692		
	1.9 SDI	09.01-04.04	47/74	Fg.-Nr. →9N..4..250 000			0 265 005 252		
	1.9 TDI	05.04-05.05	47/74	Fg.-Nr. 9N..5..000 001→			0 265 005 692		
	1.9 TDI	11.03-04.04	96	Fg.-Nr. →9N..4..250 000			0 265 005 252		
		05.04-05.05	96				0 265 005 692		
	1.2	11.01-05.04	40/47				0 265 005 303		
	1.4, FSI, TDI	09.01-06.05	55/63/74				0 265 005 303		
	1.9 SDI, TDI	09.01-05.05	47/74/96				0 265 005 303		





◀ VW

Polo [9N2]















	1.4, TDI	ABS	07.03-05.07	55/63/74	PR-Code 1CK	JBH	0 986 480 820	20,6
	1.9 SDI, TDI	ABS	07.03-05.07	47/74	PR-Code 1CK	JBH	0 986 480 820	20,6
	2.0	ABS	07.03-05.07	85	PR-Code 1CK	JBH	0 986 480 820	20,6
	1.4, TDI		07.03-05.07	55/63/74	PR-Code OEM		0 986 486 554	19,05
	1.9 SDI, TDI		07.03-05.07	47/74	PR-Code OEM		0 986 486 554	19,05
	2.0		07.03-05.07	85	PR-Code OEM		0 986 486 554	19,05
	1.4, TDI		07.03-05.07	55			0 204 031 682 ^A	
	1.9 SDI		11.03-05.07	47			0 204 031 682 ^A	
	1.4		11.03-07.04	74	Fg.-Nr. →N..40005 7000		0 265 225 162 ^T	
			12.03-07.04	63	Fg.-Nr. →N..40005 7000		0 265 225 162 ^T	
			08.04-05.05	63	Fg.-Nr. 9N..50000 001→		0 265 234 703 ^T	
					Fg.-Nr. 9N..50000 001→, 9N..5P000 001→		0 265 231 436 ^B	
			08.04-09.05	74	Fg.-Nr. 9N..50000 001→, 9N..5P000 001→9N..6P005 843		0 265 231 436 ^B	
			08.04-05.07	74	Fg.-Nr. 9N..50000 001→		0 265 234 703 ^T	
		10.05-05.07	74	Fg.-Nr. 9N..6P005 844→		0 265 232 246 ^B		
	1.4		07.03-07.04	55	Fg.-Nr. →N..40005 7000		0 265 225 162 ^T	
	1.4 TDI		08.04-09.05	55	Fg.-Nr. 9N..50000 001→, 9N..5P000 001→9N..6P005 843		0 265 231 436 ^B	
			08.04-05.07	55	Fg.-Nr. 9N..50000 001→		0 265 234 703 ^T	
			10.05-05.07	55	Fg.-Nr. 9N..6P005 844→		0 265 232 246 ^B	
	1.9 SDI		07.03-07.04	47/74	Fg.-Nr. →N..40005 7000		0 265 225 162 ^T	
1.9 TDI		08.04-09.05	47/74	Fg.-Nr. 9N..50000 001→, 9N..5P000 001→9N..6P005 843		0 265 231 436 ^B		
		08.04-05.07	47/74	Fg.-Nr. 9N..50000 001→		0 265 234 703 ^T		
		10.05-05.07	47/74	Fg.-Nr. 9N..6P005 844→		0 265 232 246 ^B		
2.0		07.03-07.04	85	Fg.-Nr. →N..40005 7000		0 265 225 162 ^T		
		08.04-09.05	85	Fg.-Nr. 9N..50000 001→, 9N..5P000 001→9N..6P005 843		0 265 231 436 ^B		
		08.04-05.07	85	Fg.-Nr. 9N..50000 001→		0 265 234 703 ^T		
		10.05-05.07	85	Fg.-Nr. 9N..6P005 844→		0 265 232 246 ^B		
	1.4		07.03-05.07	55/63/74		TW	0 265 005 252	
	1.4 TDI						0 265 005 692	
	1.9 SDI		07.03-05.07	47/74		TW	0 265 005 252	
	1.9 TDI						0 265 005 692	
	2.0		07.03-05.07	85		TW	0 265 005 252	
							0 265 005 692	

Polo [9N3]

























	1.2	ABo	04.05-12.09	40/44/47/51		JBH	0 986 480 850	20,6
		ABS	04.05-07.07	40/47		JBH,LLE	0 986 480 820	20,6
		MFD	05.07-12.09	44/51		JBH,LLE	0 986 480 820	20,6
	1.4, FSI, i	ABS	04.05-04.10	55/62/63/74		JBH,LLE	0 986 480 820	20,6
	1.4, FSI, i, TDI	ABo	04.05-04.10	51/55/58/59/62/63/74		JBH	0 986 480 850	20,6
	1.4	MFD	04.05-07.06	51/58/59	Fg.-Nr. →9N..7B000033, →9N..7D017538, →9N..7Y040366	JBH,RLE	0 986 480 820	20,6
	1.4 TDI		04.05-12.09	51/58/59		JBH,LLE	0 986 480 820	20,6
	1.6	ABo	05.06-12.09	77		JBH	0 986 480 850	20,6
		MFD	05.06-07.06	77	Fg.-Nr. →9N..7B000033, →9N..7D017538, →9N..7Y040366	JBH,RLE	0 986 480 820	20,6
			05.06-12.09	77		JBH,LLE	0 986 480 820	20,6

		S							
1.6 i	ABO 06.05→	74				JBH,TW	0 986 480 850	20,6	
	ABS 06.05→	74				JBH,TW	0 986 480 820	20,6	
1.8 GTI	ABO 09.05-11.09	110/132				JBH	0 986 480 850	20,6	
	MFD 09.05-07.06	110/132	Fg.-Nr. →9N..7B000033, →9N..7D017538, →9N..7Y040366			JBH,RLE	0 986 480 820	20,6	
	09.05-11.09	110/132				JBH,LLE	0 986 480 820	20,6	
1.9 SDI	ABO 04.05-12.09	47/74/96				JBH	0 986 480 850	20,6	
1.9 TDI	MFD 04.05-07.06	47/74/96	Fg.-Nr. →9N..7B000033, →9N..7D017538, →9N..7Y040366			JBH,RLE	0 986 480 820	20,6	
	04.05-12.09	47/74/96				JBH,LLE	0 986 480 820	20,6	
	1.4 i	06.06-04.10	62				0 986 486 060	15,87	
	1.6 i	06.05→	74				0 986 486 060	15,87	
	1.2	04.05-12.09	40/44/47/ 51	PR-Code OEJ PR-Code OEM			0 986 486 553 0 986 486 554	19,05 19,05	
	1.4, FSI, i, TDI	04.05-04.10	51/55/58/ 59/62/63/ 74	PR-Code OEJ PR-Code OEM			0 986 486 553 0 986 486 554	19,05 19,05	
	1.6	06.05→	74/77	PR-Code OEJ			0 986 486 553	19,05	
	1.6 i			PR-Code OEM			0 986 486 554	19,05	
	1.8 GTI	09.05-11.09	110/132	PR-Code OEJ PR-Code OEM			0 986 486 553 0 986 486 554	19,05 19,05	
	1.9 SDI	04.05-12.09	47/74	PR-Code OEJ			0 986 486 553	19,05	
	1.9 TDI			PR-Code OEM			0 986 486 554	19,05	
	1.9 TDI	04.05-12.09	96				0 986 486 595	29	
	1.2	04.05-12.09	40/44/47/ 51			252,288	0 204 031 681 ^A 0 204 031 682 ^A		
	1.4, FSI, i, TDI	04.05-04.10	51/55/58/59/ 62/63/74			252,288	0 204 031 681 ^A 0 204 031 682 ^A		
	1.6	06.05→	74/77				0 204 031 681 ^A		
	1.6 i					252,288	0 204 031 682 ^A		
	1.8 GTI	09.05-11.09	110/132				0 204 031 681 ^A		
	1.9 SDI	04.05-12.09	47/74/96			252,288	0 204 031 682 ^A		
	1.9 TDI					252,288	0 204 031 682 ^A		
	1.2	04.05-05.07	40			RDK	0 265 232 246 ^B 0 265 232 252 ^F 0 265 234 700 ^T		
						RDK	0 265 232 249 ^B 0 265 232 255 ^F 0 265 234 703 ^T		
		04.05-07.07	47			RDK	0 265 232 246 ^B 0 265 232 252 ^F 0 265 234 700 ^T		
						RDK	0 265 232 249 ^B 0 265 232 255 ^F 0 265 234 703 ^T		
		05.07-04.08	44/51	Fg.-Nr. →9N..8..300000 Fg.-Nr. →9N..8..300000, PR-Code OHY		RDK RDK	0 265 232 249 ^B 0 265 231 436 ^B		
		05.07-12.09	44/51			RDK RDK	0 265 232 252 ^F 0 265 234 700 ^T 0 265 232 255 ^F 0 265 234 703 ^T		
		05.08-12.09	44/51	Fg.-Nr. 9N..9..000 001→ Fg.-Nr. 9N..9..000001→		RDK RDK	0 265 232 246 ^B 0 265 232 249 ^B		

			S							
◀ VW Polo [9N3]										
1.4	04.05-07.07	55					RDK	0 265 232 246 ^B		
								0 265 232 252 ^F		
								0 265 234 700 ^T		
1.4	04.05-04.10	62/63/74					RDK	0 265 232 246 ^B		
								0 265 232 252 ^F		
								0 265 234 700 ^T		
1.4 FSI	04.05-04.10	62/63/74					RDK	0 265 232 249 ^B		
								0 265 232 255 ^F		
								0 265 234 703 ^T		
1.4 i	04.05-04.10	62/63/74					RDK	0 265 232 249 ^B		
								0 265 232 255 ^F		
								0 265 234 703 ^T		
1.4	04.05-04.08	58/59	Fg.-Nr. →9N..8..300000				RDK	0 265 232 249 ^B		
								0 265 231 436 ^B		
								0 265 232 252 ^F		
1.4 TDI	04.05-12.09	58/59	Fg.-Nr. →9N..8..300000, PR-Code OHY				RDK	0 265 234 700 ^T		
								0 265 232 255 ^F		
								0 265 234 703 ^T		
1.4 TDI	04.05-04.08	51	Fg.-Nr. →9N..8..300000				RDK	0 265 232 246 ^B		
								0 265 232 249 ^B		
								0 265 231 436 ^B		
1.4 TDI	04.05-12.09	51	Fg.-Nr. →9N..8..300000, PR-Code OHY				RDK	0 265 232 252 ^F		
								0 265 234 700 ^T		
								0 265 232 255 ^F		
1.4 TDI	05.08-12.09	58/59	Fg.-Nr. 9N..9..000 001→				RDK	0 265 232 246 ^B		
								0 265 232 249 ^B		
								0 265 231 436 ^B		
1.4 TDI	04.05-04.08	51	Fg.-Nr. →9N..8..300000				RDK	0 265 232 249 ^B		
								0 265 231 436 ^B		
								0 265 232 252 ^F		
1.4 TDI	04.05-12.09	51	Fg.-Nr. →9N..8..300000, PR-Code OHY				RDK	0 265 234 700 ^T		
								0 265 232 255 ^F		
								0 265 234 703 ^T		
1.4 TDI	05.08-12.09	51	Fg.-Nr. 9N..9..000 001→				RDK	0 265 232 246 ^B		
								0 265 232 249 ^B		
								0 265 231 436 ^B		
1.6	05.06-04.08	77	Fg.-Nr. →9N..8..300000				RDK	0 265 232 249 ^B		
								0 265 231 436 ^B		
								0 265 232 252 ^F		
1.6	05.06-12.09	77	Fg.-Nr. →9N..8..300000, PR-Code OHY				RDK	0 265 234 700 ^T		
								0 265 232 255 ^F		
								0 265 234 703 ^T		
1.6	05.08-12.09	77	Fg.-Nr. 9N..9..000 001→				RDK	0 265 232 246 ^B		
								0 265 232 249 ^B		
								0 265 231 436 ^B		
1.6 i	06.05→	74					RDK	0 265 232 246 ^B		
								0 265 232 252 ^F		
								0 265 234 700 ^T		
1.6 i	06.05→	74					RDK	0 265 232 249 ^B		
								0 265 232 255 ^F		
								0 265 234 703 ^T		
1.8 GTI	09.05-04.08	110/132	Fg.-Nr. →9N..8..300000				RDK	0 265 232 249 ^B		
								0 265 231 436 ^B		
								0 265 232 252 ^F		
1.8 GTI	09.05-11.09	110/132	Fg.-Nr. →9N..8..300000, PR-Code OHY				RDK	0 265 234 700 ^T		
								0 265 232 255 ^F		
								0 265 234 703 ^T		
1.8 GTI	09.05-11.09	110/132	Fg.-Nr. 9N..9..000 001→				RDK	0 265 232 246 ^B		
								0 265 232 249 ^B		
								0 265 231 436 ^B		
1.9 SDI	04.05-04.08	47/74/96	Fg.-Nr. →9N..8..300000				RDK	0 265 232 249 ^B		
								0 265 231 436 ^B		
								0 265 232 252 ^F		
1.9 TDI	04.05-12.09	47/74/96	Fg.-Nr. →9N..8..300000, PR-Code OHY				RDK	0 265 234 700 ^T		
								0 265 232 255 ^F		
								0 265 234 703 ^T		











		S							
1.9 SDI		05.08-12.09	47/74/96	Fg.-Nr. 9N..9..000 001→	RDK		0 265 232 246 ^B		
1.9 TDI				Fg.-Nr. 9N..9..000001→	RDK		0 265 232 249 ^B		
 1.2		04.05-12.09	40/44/47/51				0 265 005 692		
1.4, FSI, i, TDI		04.05-04.10	51/55/58/59/ 62/63/74				0 265 005 692		
1.6, i		06.05→	74/77				0 265 005 692		
1.8 GTI		09.05-11.09	110/132				0 265 005 692		
1.9 SDI, TDI		04.05-12.09	47/74/96				0 265 005 692		
Polo [9N4]									
									
 1.4 TDI		04.05→	58				0 265 232 246 ^B		
Polo [80]									
									
 1.0		10.90-09.94	33		JBH		F 026 003 180	20,6	
					RLE		0 986 480 422	17,46	
							0 204 123 329	19	
1.3		10.90-09.94	40/56-59		JBH		F 026 003 180	20,6	
					RLE		0 986 480 422	17,46	
							0 204 123 329	19	
1.4 D		10.90-09.94	35		JBH		F 026 003 180	20,6	
					RLE		0 986 480 422	17,46	
							0 204 123 329	19	
 1.0		10.90-09.94	33		LLE		0 204 125 054		
1.3		10.90-09.94	40		LLE		0 204 125 054		
 1.0		10.90-09.94	33				0 986 482 006 ^A		
1.3		10.90-09.94	40/56-59				0 986 482 006 ^A		
1.4 D		10.90-09.94	35				0 986 482 006 ^A		
Santana [32]									
									
 1.8 Mi		10.96-01.98	74		WBH	BRB, BSY	0 204 032 595		
		ABS	10.96-01.98	74		HYK, WBH	0 204 032 825		
						JBH	0 204 032 994		
						HYK, WBH	0 204 032 826		
Scirocco R [138]									
									
 2.0 TSI		05.14→	188/206	PR-Code 1ZP, PR-Code 1ZD	JBH, LLE		0 986 480 870	22	
 2.0 TSI		05.14→	188/206				0 986 486 595	29	
Scirocco [137]									
									
 1.4 TSI		08.08→	90/118	PR-Code 1ZP, PR-Code 1ZD	JBH, LLE		0 986 480 870	22	

		S							
◀ VW Scirocco [137]									
	2.0 TDI	08.08→	100/103/	PR-Code 1ZP, PR-Code 1ZD	JBH, LLE	0986 480 870	22		
	2.0 TSI		125/130/ 147/155/ 188/195						
	1.4 TSI	08.08-10.12	118	PR-Code OEJ		0986 486 576	19		
				PR-Code OEM		0986 486 554	19,05		
		11.08→	90			0986 486 554	19,05		
		09.12→	118			0986 486 576	19		
	2.0 TDI	10.08-11.10	103/125	PR-Code OEJ		0986 486 576	19		
				PR-Code OEM		0986 486 554	19,05		
				PR-Code OEN		0986 486 595	29		
		11.10→	100			0986 486 595	29		
			103/125			0986 486 595	29		
	2.0 TDI, TSI	08.08→	130/147/155/188/195			0986 486 595	29		
Scirocco [138]									
	1.4 TSI	05.14→	90/92/118	PR-Code 1ZP, PR-Code 1ZD	JBH, LLE	0986 480 870	22		
	2.0 TDI	05.14→	110/132/	PR-Code 1ZP, PR-Code 1ZD	JBH, LLE	0986 480 870	22		
	2.0 TSI		135/155/ 162						
	1.4 TSI	05.14→	90/92			0986 486 554	19,05		
			118			0986 486 576	19		
	2.0 TSI	05.14→	132/155/162			0986 486 595	29		
Sharan [7M8]									
	1.8 T	ABS	11.97-02.00	110		JBH	0986 481 047		
	1.9 TDI	ABO	09.95-07.96	66		JBH	0986 480 930	23,81	
			07.96-08.97	66	Fg.-Nr. →7M..W..020 918	JBH	0986 480 930	23,81	
			09.96-08.97	81	Fg.-Nr. →7M..W..020 918	JBH	0986 480 930	23,81	
		ABS	09.95-07.96	66		JBH	0986 480 933	23,81	
			07.96-08.97	66	Fg.-Nr. →7M..W..020 918	JBH	0986 480 933	23,81	
			09.96-08.97	81	Fg.-Nr. →7M..W..020 918	JBH	0986 480 933	23,81	
			09.97-02.00	66	Fg.-Nr. 7M..W..020 919→	JBH	0986 481 047		
				81	Fg.-Nr. 7M..W..020 919→	JBH	0986 481 047		
			03.99-02.00	66		JBH	0986 481 047		
			08.99-02.00	81		JBH	0986 481 047		
	2.0	ABO	09.95-08.97	85	Fg.-Nr. →7M..W..020 918	JBH	0986 480 930	23,81	
		ABS	09.95-08.97	85	Fg.-Nr. →7M..W..020 918	JBH	0986 480 933	23,81	
			09.97-02.00	85	Fg.-Nr. 7M..W..020 919→	JBH	0986 481 047		
	2.8	ABO	09.95-08.97	128	Fg.-Nr. →7M..W..020 918	JBH	0986 480 930	23,81	
	2.8 syncro	ABS	09.95-08.97	128	Fg.-Nr. →7M..W..020 918	JBH	0986 480 933	23,81	
			09.97-02.00	128	Fg.-Nr. 7M..W..020 919→	JBH	0986 481 047		
			04.98-02.00	128		JBH	0986 481 047		
	1.8 T		11.97-02.00	110			0986 486 050	19,05	
	1.9 TDI		09.95-02.00	66/81			0986 486 050	19,05	
	2.0		09.95-02.00	85			0986 486 050	19,05	
	2.8, syncro		09.95-02.00	128			0986 486 050	19,05	
Sharan [7M9, 7M6]									
	1.8 T	MFD	05.00-10.02	110	Fg.-Nr. →7M..3..029 999	JBH	0986 480 819		
		OFD	05.00-03.10	110		JBH, RLE	0986 481 047		
	1.9 TDI, TDI 4Motion	MFD	04.00-10.02	66/85	Fg.-Nr. →7M..3..029 999	JBH	0986 480 819		
	1.9 TDI 4Motion	OFD	05.00-03.10	85		JBH, RLE	0986 481 047		

		S							
		2.0	MFD 05.00-10.02	85	Fg.-Nr. →7M..3..029 999	JBH	0 986 480 819		
		2.8, 4Motion	MFD 05.00-10.02	150	Fg.-Nr. →7M..3..029 999	JBH	0 986 480 819		
		1.8 T	05.00-03.10	110			0 986 486 050	19,05	
		1.9 TDI, TDI 4Motion	04.00-03.10	66/85/96/110			0 986 486 050	19,05	
		2.0, TDI	05.00-03.10	85/100/103			0 986 486 050	19,05	
		2.8, 4Motion	05.00-03.10	150			0 986 486 050	19,05	
		1.8 T	05.00-03.10	110			0 986 486 595	29	
		1.9 TDI, TDI 4Motion	04.00-03.10	66/85/96/110			0 986 486 595	29	
		2.0, TDI	05.00-03.10	85/100/103			0 986 486 595	29	
		2.8, 4Motion	05.00-03.10	150			0 986 486 595	29	
Sharan [7N1]									
		1.4 TSI	05.10→	110			0 986 486 595	29	
		2.0 TDI, TDI 4Motion	05.10→	85/100/103/125			0 986 486 595	29	
Tiguan [5N1]									
		1.4 TSI, TSI 4Motion	11.07-05.11	90/110			0 986 486 595	29	
		2.0 TDI, TDI 4Motion, TFSI 4Motion, TSI, TSI 4Motion	11.07-05.11	81/100/103/ 120/125/147			0 986 486 595	29	
Tiguan [5N2]									
		1.4 TSI, TSI 4Motion	05.11→	90/110/118			0 986 486 595	29	
		2.0 TDI 4Motion, TSI 4Motion	05.11→	130/132/155			0 986 486 595	29	
Touareg [7LA]									
		2.5 TDI	01.03-11.06	120/128		JBH, LLE	0 986 480 992	27	
		3.0 TDI	11.04-11.06	155/165		JBH, LLE	0 986 480 992	27	
		3.2	11.02-11.06	162		JBH, LLE	0 986 480 992	27	
						JBH	0 986 480 992	27	
		3.6 FSI	08.05-11.06	206		JBH, LLE	0 986 480 992	27	
		4.2, FSI	12.02-11.06	228/257		JBH, LLE	0 986 480 992	27	
		5.0 TDI	11.02-11.06	230		JBH, LLE	0 986 480 992	27	
		6.0	08.04-11.06	331		JBH, LLE	0 986 480 992	27	
Touareg [7L6]									
		2.5 TDI	12.06-05.10	120/128		JBH, LLE	0 986 480 992	27	
		3.0 TDI	12.06-05.10	155/165/176		JBH, LLE	0 986 480 992	27	
		3.6 FSI	12.06-05.10	206		JBH, LLE	0 986 480 992	27	
		4.2 FSI	12.06-05.10	257		JBH, LLE	0 986 480 992	27	
		5.0 TDI	12.06-02.09	230		JBH	0 986 480 992	27	
			12.06-05.10	230/258		JBH, LLE	0 986 480 992	27	
		6.0	12.06-05.10	316/331		JBH, LLE	0 986 480 992	27	
Touran [1T1]									
		1.4 TSI	02.06-11.06	103		JBH, LLE	0 986 480 870	22	
		1.6, FSI	02.03-11.06	75/85		JBH, LLE	0 986 480 870	22	
		1.9 TDI	02.03-11.06	66/74/77		JBH, LLE	0 986 480 870	22	
		2.0 EcoFuel, FSI, TDI	02.03-11.06	80/100/103/110/125		JBH, LLE	0 986 480 870	22	



		S							
◀ VW Touran [1T1]									
	1.4 TSI	02.06-11.06	103	PR-Code OEJ			0 986 486 576	19	
				PR-Code OEM			0 986 486 554	19,05	
	1.6	02.03-11.06	75/85	PR-Code OEJ			0 986 486 576	19	
	1.6 FSI			PR-Code OEM			0 986 486 554	19,05	
	1.9 TDI	02.03-11.06	66/74/77	PR-Code OEJ			0 986 486 576	19	
				PR-Code OEM			0 986 486 554	19,05	
	2.0 EcoFuel	02.06-11.06	80	PR-Code OEJ			0 986 486 576	19	
				PR-Code OEM			0 986 486 554	19,05	
	2.0 FSI	10.03-11.06	110	PR-Code OEJ			0 986 486 576	19	
				PR-Code OEM			0 986 486 554	19,05	
	2.0 TDI	02.03-11.06	100/103				0 986 486 595	29	
		11.05-11.06	125				0 986 486 595	29	
Touran [1T2]									
	1.4 TSI, TSI EcoFuel	11.06-05.10	103/110/125		JBH, LLE		0 986 480 870	22	
	1.6, FSI	11.06-05.10	75/85		JBH, LLE		0 986 480 870	22	
	1.9 TDI	11.06-05.10	66/77		JBH, LLE		0 986 480 870	22	
	2.0 EcoFuel, FSI, TDI	11.06-05.10	80/100/103/110/125		JBH, LLE		0 986 480 870	22	
	1.4 TSI	11.06-05.10	103/110/125	PR-Code OEJ			0 986 486 576	19	
	1.4 TSI EcoFuel			PR-Code OEM			0 986 486 554	19,05	
	1.6, FSI	11.06-05.10	75/85	PR-Code OEM			0 986 486 554	19,05	
	1.9 TDI	11.06-05.10	66/77	PR-Code OEJ			0 986 486 576	19	
				PR-Code OEM			0 986 486 554	19,05	
				PR-Code OEN			0 986 486 595	29	
	2.0 EcoFuel	11.06-05.10	80	PR-Code OEM			0 986 486 554	19,05	
	2.0 FSI	11.06-01.07	110	PR-Code OEM			0 986 486 554	19,05	
	2.0 TDI	11.06-05.10	100/103/125				0 986 486 595	29	
				PR-Code OEM			0 986 486 554	19,05	
Touran [1T3]									
	1.2 TSI	05.10→	77		JBH, LLE		0 986 480 870	22	
	1.4 TSI, TSI EcoFuel	05.10→	103/110/125		JBH, LLE		0 986 480 870	22	
	1.6 TDI	05.10→	66/77		JBH, LLE		0 986 480 870	22	
	2.0 TDI	05.10→	81/103/125/130		JBH, LLE		0 986 480 870	22	
	1.2 TSI	05.10→	77				0 986 486 554	19,05	
	1.4 TSI	05.10-09.12	103	PR-Code OEJ			0 986 486 576	19	
				PR-Code OEM			0 986 486 554	19,05	
			125	PR-Code OEM			0 986 486 554	19,05	
		09.12→	103				0 986 486 576	19	
	1.4 TSI EcoFuel	05.10→	110				0 986 486 576	19	
	1.6 TDI	05.10→	66/77				0 986 486 576	19	
	2.0 TDI	05.10→	103				0 986 486 595	29	
Touran [1T3]									
	2.0 TDI	04.13→	81		JBH, LLE		0 986 480 870	22	
Transporter T4 [70, 7D]									
	1.9 D	ABO 09.90-04.97	45		254, JBH		0 986 481 030	25,4	
		06.95-04.97	45	Fg.-Nr. 70..S..127 806→	JBH		0 986 480 930	23,81	
		ABO, 09.90-05.95	45	Fg.-Nr. →70..S..127 805	JBH		F 026 003 563	22	
		OFD							

		S								
1.9 D	ABS	09.90-05.95	45	Fg.-Nr. →70..S..127 805		JBH	0 986 480 834	22,2		
	ABS,	09.90-04.97	45			254, JBH	0 986 481 007	25,4		
	OFD	06.95-04.97	45	Fg.-Nr. 70..S..127 806→		JBH	0 986 480 933	23,81		
	MFD	09.90-04.97	45			JBH	0 986 481 007	25,4		
1.9 D Turbo	ABO	10.92-05.95	50	Fg.-Nr. →70..S..127 805		JBH	F 026 003 563	22		
		10.92-06.03	50			254, JBH	0 986 481 030	25,4		
		06.95-06.03	50	Fg.-Nr. 70..S..127 806→		JBH	0 986 480 930	23,81		
	ABS	10.92-05.95	50	Fg.-Nr. →70..S..127 805		JBH	0 986 480 834	22,2		
		10.92-06.03	50			254, JBH	0 986 481 007	25,4		
		06.95-06.03	50	Fg.-Nr. 70..S..127 806→		JBH	0 986 480 933	23,81		
2.0	ABO	09.90-06.03	62			254, JBH	0 986 481 030	25,4		
		06.95-06.03	62	Fg.-Nr. 70..S..127 806→		JBH	0 986 480 930	23,81		
	ABO,	09.90-05.95	62	Fg.-Nr. →70..S..127 805		JBH	F 026 003 563	22		
	OFD									
	ABS	09.90-05.95	62	Fg.-Nr. →70..S..127 805		JBH	0 986 480 834	22,2		
	ABS,	09.90-06.03	62			254, JBH	0 986 481 007	25,4		
	OFD	06.95-06.03	62	Fg.-Nr. 70..S..127 806→		JBH	0 986 480 933	23,81		
	MFD	09.90-06.03	62			JBH	0 986 481 007	25,4		
2.4 D	ABO	05.97-06.03	55			JBH	0 986 480 930	23,81		
						254, JBH	0 986 481 030	25,4		
	ABS	05.97-06.03	55			JBH	0 986 480 933	23,81		
						254, JBH	0 986 481 007	25,4		
	ABS,	09.90-05.98	57			254, JBH	0 986 481 007	25,4		
	OFD									
	MFD	09.90-05.98	57			JBH	0 986 481 007	25,4		
2.4 D Syncro	ABS,	11.92-09.98	57			254, JBH	0 986 481 007	25,4		
	OFD									
	MFD	11.92-09.98	57			JBH	0 986 481 007	25,4		
2.4 D	ABO	09.90-09.98	57			254, JBH	0 986 481 030	25,4		
		06.95-09.98	57	Fg.-Nr. 70..S..127 806→		JBH	0 986 480 930	23,81		
2.4 D Syncro	ABO,	09.90-05.95	57	Fg.-Nr. →70..S..127 805		JBH	F 026 003 563	22		
	OFD									
	ABS	09.90-05.95	57	Fg.-Nr. →70..S..127 805		JBH	0 986 480 834	22,2		
	ABS,	06.95-09.98	57	Fg.-Nr. 70..S..127 806→		JBH	0 986 480 933	23,81		
	OFD									
		MFD	01.94-06.03	81			JBH	0 986 481 007	25,4	
2.5	ABO	06.95-10.96	81	Fg.-Nr. 70..S..127 806→		JBH	0 986 480 930	23,81		
		09.95-12.95	81			JBH	0 986 480 930	23,81		
		08.96-06.03	81			JBH	0 986 480 930	23,81		
	ABS,	01.94-06.03	81			254, JBH	0 986 481 007	25,4		
	OFD	06.95-10.96	81	Fg.-Nr. 70..S..127 806→		JBH	0 986 480 933	23,81		
		09.95-12.95	81			JBH	0 986 480 933	23,81		
		08.96-06.03	81			JBH	0 986 480 933	23,81		
			85			254, JBH	0 986 481 007	25,4		
		MFD	01.94-06.03	81			JBH	0 986 481 007	25,4	
			08.96-06.03	85			JBH	0 986 481 007	25,4	
2.5	ABO	01.94-06.03	81			254, JBH	0 986 481 030	25,4		
2.5 Syncro	ABS	01.94-05.95	81	Fg.-Nr. →70..S..127 805		JBH	0 986 480 834	22,2		
	ABS,	05.96-06.03	85			JBH	0 986 480 933	23,81		
	OFD									
2.5	ABO	05.96-06.03	85/111			JBH	0 986 480 930	23,81		
						254, JBH	0 986 481 030	25,4		
2.5 Syncro	ABO,	01.94-05.95	75/81	Fg.-Nr. →70..S..127 805		JBH	F 026 003 563	22		
	OFD									
2.5 Syncro	ABO	06.95-10.96	81	Fg.-Nr. 70..S..127 806→		JBH	0 986 480 930	23,81		
		06.97-11.01	81			JBH	0 986 480 930	23,81		
	ABS,	01.94-10.96	81			254, JBH	0 986 481 007	25,4		
	OFD	06.95-10.96	81	Fg.-Nr. 70..S..127 806→		JBH	0 986 480 933	23,81		
		05.96-06.03	85			254, JBH	0 986 481 007	25,4		
		06.97-11.01	81			JBH	0 986 480 933	23,81		
						254, JBH	0 986 481 007	25,4		
		MFD	01.94-10.96	81			JBH	0 986 481 007	25,4	
			05.96-06.03	85			JBH	0 986 481 007	25,4	
			06.97-11.01	81			JBH	0 986 481 007	25,4	



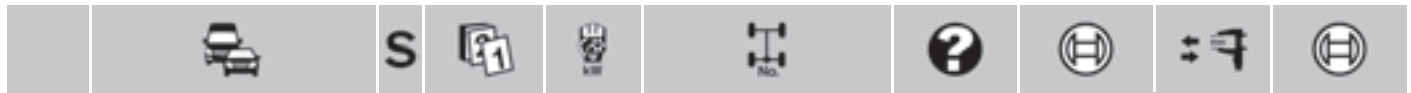















◀ VW Transporter T4 [70, 7D]

2.5 TDI	ABO	06.95-06.03	75	Fg.-Nr. 70...S..127 806→	JBH	0986 480 930	23,81
		05.98-06.03	65		JBH	0986 480 930	23,81
					254,JBH	0986 481 030	25,4
		05.99-06.03	75		JBH	0986 480 930	23,81
	ABS	01.95-05.95	75	Fg.-Nr. →70...S..127 805	JBH	0986 480 834	22,2
	ABS,	01.95-06.03	75		254,JBH	0986 481 007	25,4
	OFD	06.95-06.03	75	Fg.-Nr. 70...S..127 806→	JBH	0986 480 933	23,81
		05.98-06.03	65		JBH	0986 480 933	23,81
					254,JBH	0986 481 007	25,4
			111		JBH	0986 480 933	23,81
					254,JBH	0986 481 007	25,4
		05.99-06.03	75		JBH	0986 480 933	23,81
	MFD	01.95-06.03	75		JBH	0986 481 007	25,4
		05.98-06.03	65		JBH	0986 481 007	25,4
			111		JBH	0986 481 007	25,4
2.5 TDI Syncro	ABO	03.98-06.03	75		JBH	0986 480 930	23,81
	ABS	04.01-06.03	75		JBH	0986 480 933	23,81
	ABS,	03.98-06.03	75		JBH	0986 480 933	23,81
	OFD				254,JBH	0986 481 007	25,4
	MFD	03.98-06.03	75		JBH	0986 481 007	25,4
2.5 TDI, TDI Syncro	ABO	01.95-06.03	75		254,JBH	0986 481 030	25,4
2.8	ABO	01.96-06.03	103/150		JBH	0986 480 930	23,81
					254,JBH	0986 481 030	25,4
	ABS,	01.96-05.00	103		JBH	0986 480 933	23,81
	OFD				254,JBH	0986 481 007	25,4
		05.00-06.03	150		JBH	0986 480 933	23,81
					254,JBH	0986 481 007	25,4
	MFD	01.96-05.00	103		JBH	0986 481 007	25,4
		05.00-06.03	150		JBH	0986 481 007	25,4











		1.9 D	09.90-06.03	45/50	TW	0986 486 037	19,05
		1.9 D Turbo					0986 486 048
		2.0	09.90-06.03	62	TW	0986 486 037	19,05
						0986 486 048	15,87
		2.4 D	09.90-06.03	55/57	TW	0986 486 037	19,05
		2.4 D Syncro				0986 486 048	15,87
		2.5, Syncro, TDI	01.94-06.03	81/85/111	TW	0986 486 037	19,05
						0986 486 048	15,87
		2.5 TDI	01.95-06.03	75	TW	0986 486 048	15,87
			05.98-06.03	65	TW	0986 486 037	19,05
						0986 486 048	15,87
		2.5 TDI Syncro	03.98-06.03	75	TW	0986 486 048	15,87
			04.01-06.03	75		0986 486 048	15,87
		2.5 TDI, TDI Syncro	01.95-06.03	75	TW	0986 486 037	19,05
		2.8	01.96-06.03	103/150	TW	0986 486 037	19,05
						0986 486 048	15,87

		1.9 D	09.90-04.97	45		0986 486 537	23,8
		1.9 D Turbo	10.92-06.03	50	TW	0986 486 537	23,8
						0986 486 538	19
						0986 486 576	19
		2.0	09.90-04.97	62		0986 486 537	23,8
			05.97-06.03	62		0986 486 576	19
		2.4 D	05.97-06.03	55	TW	0986 486 538	19
						0986 486 576	19
		2.4 D	09.90-04.97	57		0986 486 537	23,8
		2.4 D Syncro	05.97-09.98	57		0986 486 576	19
		2.5	01.94-04.97	81/85		0986 486 537	23,8
		2.5 Syncro	05.97-06.03	81/85		0986 486 576	19
		2.5 TDI	05.98-06.03	65		0986 486 576	19
		2.8	05.00-06.03	150		0986 486 576	19

		S							
	1.9 D, D Turbo	09.90-06.03	45/50				0 986 482 036 ^A		
	2.0	09.90-06.03	62				0 986 482 036 ^A		
	2.4 D, D Syncro	09.90-06.03	55/57				0 986 482 036 ^A		
	2.5, Syncro, TDI, TDI Syncro	01.94-06.03	65/75/81/85/111				0 986 482 036 ^A		
	2.8	01.96-06.03	103/150				0 986 482 036 ^A		
	1.9 D	09.90-04.97	45				0 265 202 454 ^M		
		01.96-04.97	45				0 265 220 434 ^F		
	1.9 D Turbo	10.92-06.03	50				0 265 202 454 ^M		
		10.97-06.03	50	Fg.-Nr. 70..W..062 420→			0 265 220 434 ^F		
	2.0	09.90-06.03	62				0 265 202 454 ^M		
		01.96-06.03	62				0 265 220 434 ^F		
	2.4 D	05.97-06.03	55				0 265 202 454 ^M		
		10.97-06.03	55	Fg.-Nr. 70..W..062 420→			0 265 220 434 ^F		
	2.4 D	09.90-09.98	57				0 265 202 454 ^M		
	2.4 D Syncro	01.96-09.98	57				0 265 220 434 ^F		
	2.5, Syncro, TDI, TDI Syncro	01.94-06.03	65/75/81/85/111				0 265 202 454 ^M		
		01.96-06.03	65/75/81/85/111				0 265 220 434 ^F		
	2.8	01.96-05.00	103				0 265 202 454 ^M		
		10.97-05.00	103	Fg.-Nr. 70..W..062 420→			0 265 220 434 ^F		
		05.00-06.03	150				0 265 202 454 ^M		
						0 265 220 434 ^F			
	1.9 D	09.90-12.95	45/50				0 265 100 072 ^H		
	1.9 D Turbo	09.90-06.03	45/50			1KX,326	0 265 109 612 ^M		
						281,284,GRG	0 265 109 602 ^M		
	2.0	09.90-12.95	62				0 265 100 072 ^H		
		09.90-06.03	62			1KX,326	0 265 109 612 ^M		
						281,284,GRG	0 265 109 602 ^M		
	2.4 D	05.97-06.03	55			1KX,326	0 265 109 612 ^M		
						281,284,GRG	0 265 109 602 ^M		
	2.4 D	09.90-12.95	57				0 265 100 072 ^H		
	2.4 D Syncro	09.90-09.98	57			1KX,326	0 265 109 612 ^M		
						281,284,GRG	0 265 109 602 ^M		
	2.5	01.94-12.95	81				0 265 100 072 ^H		
	2.5 Syncro	01.94-06.03	81			1KX,326	0 265 109 612 ^M		
						281,284,GRG	0 265 109 602 ^M		
	2.5, Syncro, TDI	05.96-06.03	85/111			1KX,326	0 265 109 612 ^M		
						281,284,GRG	0 265 109 602 ^M		
	2.5 TDI	01.95-12.95	75				0 265 100 072 ^H		
		01.95-06.03	75			1KX,326	0 265 109 612 ^M		
						281,284,GRG	0 265 109 602 ^M		
		05.98-06.03	65			1KX,326	0 265 109 612 ^M		
						281,284,GRG	0 265 109 602 ^M		
	2.5 TDI Syncro	03.98-06.03	75			1KX,326	0 265 109 612 ^M		
						281,284,GRG	0 265 109 602 ^M		
	04.01-05.02	75	Fg.-Nr. →70..3..019 101		GRG	0 265 109 602 ^M			
	06.02-06.03	75	Fg.-Nr. 70..3..019 102→			0 265 109 612 ^M			
2.8	01.96-06.03	103/150			1KX,326	0 265 109 612 ^M			
					281,284,GRG	0 265 109 602 ^M			
	1.9 D, D Turbo	09.90-06.03	45/50				0 265 005 214		
	2.0	09.90-06.03	62				0 265 005 214		
	2.4 D, D Syncro	09.90-06.03	55/57				0 265 005 214		
	2.5, Syncro, TDI, TDI Syncro	01.94-06.03	65/75/81/85/111				0 265 005 214		
	2.8	01.96-06.03	103/150				0 265 005 214		
Transporter T5 [7E]									
									
	2.0 TDI, TDI 4Motion, TSI, TSI 4Motion	09.09→	100/103/110/ 132/150				0 986 486 595	29	

		S							
◀ VW									
Transporter T5 [7F]									
	2.0 TDI, TDI 4Motion, TSI	09.09→	100/103/110/132				0 986 486 595	29	
Transporter T5 [7H]									
	1.9 TDI	04.03-11.09	62/63/75/77		JBH		0 986 480 992	27	
	2.0	06.03-11.09	85		JBH		0 986 480 992	27	
	2.5 TDI	02.03-11.09	96		JBH,LLE		0 986 480 992	27	
			128		JBH,LLE		0 986 480 992	27	
	2.5 TDI 4Motion	07.04-11.09	96		JBH,LLE		0 986 480 992	27	
			128		JBH,LLE		0 986 480 992	27	
	3.2	02.03-06.04	170		JBH		0 986 480 992	27	
			173		JBH		0 986 480 992	27	
	3.2 4Motion	07.04-11.09	96		JBH		0 986 480 992	27	
			128		JBH		0 986 480 992	27	
	2.5 TDI, TDI 4Motion	02.03-11.09	96/120/128				0 986 486 595	29	
	3.2, 4Motion	02.03-11.09	170/173				0 986 486 595	29	
Transporter T5 [7J]									
	1.9 TDI	04.03-11.09	62/63/75/77		JBH		0 986 480 992	27	
	2.0	06.03-11.09	85		JBH		0 986 480 992	27	
	2.5 TDI, TDI 4Motion	04.03-11.09	96/128		JBH		0 986 480 992	27	
	3.2, 4Motion	02.04-11.09	170		JBH		0 986 480 992	27	
	2.5 TDI	04.03-11.09	96/128				0 986 486 595	29	
	2.5 TDI 4Motion								
Transporter T6 [SF]									
	2.0 TDI, TDI 4Motion, TFSI	04.15→	103/110/132				0 986 486 595	29	
Transporter T6 [SG]									
	2.0 TDI, TDI 4Motion, TFSI	04.15→	103/110/132/150				0 986 486 595	29	
Vento									
	2.0 i	08.96-12.98	85		JBH		F 026 003 562	20,6	
							F 026 003 563	22	
	2.0 i	08.96-12.98	85				0 204 131 697 ^A		



		S							
Vento [1H2]									
									
	1.4	ABO	11.91-12.97	44			JBH, LLE	0 986 480 878	23,8
							JBH, RLE	F 026 003 562	20,6
								F 026 003 563	22
		ABS	11.91-12.94	44	Fg.-Nr. →1H..SW..385 334		JBH, LLE	0 986 480 878	23,8
			01.95-07.95	44	Fg.-Nr. 1H..SW..385 335→		JBH, LLE	0 986 480 987	23,81
								0 986 481 016	22,2
			07.95-12.97	44			JBH, LLE	0 986 480 987	23,81
								0 986 481 016	22,2
	1.6		09.92-09.94	55			JBH, LLE	0 986 480 878	23,8
		ABO	09.92-12.97	55			JBH, RLE	F 026 003 562	20,6
								F 026 003 563	22
			10.94-12.97	55			JBH, LLE	0 986 480 878	23,8
				74			JBH, LLE	0 986 480 878	23,8
							JBH, RLE	F 026 003 562	20,6
								F 026 003 563	22
		ABS	10.94-12.94	55/74	Fg.-Nr. →1H..SW..385 334		JBH, LLE	0 986 480 878	23,8
			01.95-12.95	55/74	Fg.-Nr. 1H..SW..385 335→		JBH, LLE	0 986 480 987	23,81
								0 986 481 016	22,2
			07.95-12.97	55/74			JBH, LLE	0 986 480 987	23,81
								0 986 481 016	22,2
	1.8		11.91-09.94	66			JBH, LLE	0 986 480 878	23,8
		ABO	11.91-12.97	55			JBH, LLE	0 986 480 878	23,8
							JBH, RLE	F 026 003 562	20,6
								F 026 003 563	22
				66			JBH, RLE	F 026 003 562	20,6
								F 026 003 563	22
			10.94-12.97	66			JBH, LLE	0 986 480 878	23,8
		ABS	11.91-12.94	55/66	Fg.-Nr. →1H..SW..385 334		JBH, LLE	0 986 480 878	23,8
			01.95-12.97	55/66	Fg.-Nr. 1H..SW..385 335→		JBH, LLE	0 986 480 987	23,81
								0 986 481 016	22,2
	1.9 D	ABS	11.91-12.94	47	Fg.-Nr. →1H..SW..385 334		JBH, LLE	0 986 480 878	23,8
			01.95-12.97	47	Fg.-Nr. 1H..SW..385 335→		JBH, LLE	0 986 480 987	23,81
								0 986 481 016	22,2
	1.9 D, SDI, TD, TDI	ABO	11.91-12.97	47/55/66/ 81			JBH, LLE	0 986 480 878	23,8
							JBH, RLE	F 026 003 562	20,6
								F 026 003 563	22
	1.9 SDI	ABS	01.95-12.97	47			JBH, LLE	0 986 480 987	23,81
								0 986 481 016	22,2
	1.9 TD	ABS	11.91-12.94	55	Fg.-Nr. →1H..SW..385 334		JBH, LLE	0 986 480 878	23,8
			01.95-12.97	55	Fg.-Nr. 1H..SW..385 335→		JBH, LLE	0 986 480 987	23,81
								0 986 481 016	22,2
	1.9 TDI	ABS	09.93-12.94	66	Fg.-Nr. →1H..SW..385 334		JBH, LLE	0 986 480 878	23,8
			01.95-07.96	66	Fg.-Nr. 1H..SW..385 335→		JBH, LLE	0 986 480 987	23,81
								0 986 481 016	22,2
			02.96-12.97	81			JBH, LLE	0 986 480 987	23,81
								0 986 481 016	22,2
			08.96-12.97	66			JBH, LLE	0 986 480 987	23,81
								0 986 481 016	22,2
	2.0		11.91-09.94	85			JBH, LLE	0 986 480 878	23,8
		ABO	11.91-12.97	85			JBH, RLE	F 026 003 562	20,6
								F 026 003 563	22
			10.94-12.97	79			JBH, LLE	0 986 480 878	23,8
							JBH, RLE	F 026 003 562	20,6
								F 026 003 563	22
				85			JBH, LLE	0 986 480 878	23,8
		ABS	10.94-12.94	79	Fg.-Nr. →1H..SW..385 334		JBH, LLE	0 986 480 878	23,8
				85	Fg.-Nr. →1H..SW..385 334		JBH, LLE	0 986 480 878	23,8
			10.94-12.97	85			JBH, LLE	0 986 480 987	23,81
								0 986 481 016	22,2

		S							
◀ VW Vento [1H2]									
2.0	ABS	01.95-12.97	79	Fg.-Nr. 1H..SW..385 335→	JBH,LLE	0986 480 987	23,81		
						0986 481 016	22,2		
2.8	ABO	01.92-12.97	120/128		JBH,LLE	0986 480 878	23,8		
					JBH,RLE	F 026 003 562	20,6		
						F 026 003 563	22		
	ABS	01.92-12.94	120/128	Fg.-Nr. →1H..SW..385 334	JBH,LLE	0986 480 878	23,8		
		01.95-12.97	120/128	Fg.-Nr. 1H..SW..385 335→	JBH,LLE	0986 480 987	23,81		
						0986 481 016	22,2		
	1.4	11.91-12.97	44		BD9,RLE	0986 485 111			
	1.6	09.92-12.97	55/74		BD9,RLE	0986 485 111			
	1.8	11.91-12.97	55/66		BD9,RLE	0986 485 111			
	1.9 D, SDI, TD, TDI	11.91-12.97	47/55/66/81		BD9,RLE	0986 485 111			
	2.0	11.91-12.97	79/85		BD9,RLE	0986 485 111			
	2.8	01.92-12.97	120/128		BD9,RLE	0986 485 111			
	1.4	11.91-12.97	44		LLE	0986 486 038	19		
					RLE	0986 486 045	19,05		
	1.6	09.92-12.97	55/74		LLE	0986 486 038	19		
					RLE	0986 486 045	19,05		
	1.8	11.91-12.97	55/66		LLE	0986 486 038	19		
					RLE	0986 486 045	19,05		
	1.9 D	11.91-12.97	47		LLE	0986 486 038	19		
					RLE	0986 486 045	19,05		
	1.9 SDI	01.95-12.97	47		LLE	0986 486 146	15,87		
	1.9 TD	11.91-12.97	55/66/81		LLE	0986 486 038	19		
	1.9 TDI				RLE	0986 486 045	19,05		
	2.0	11.91-12.97	79/85		LLE	0986 486 038	19		
RLE					0986 486 045	19,05			
2.8	01.92-12.97	120/128		LLE	0986 486 038	19			
				RLE	0986 486 045	19,05			
	1.4	11.91-12.97	44			0986 486 537	23,8		
	1.6	09.92-12.97	55/74			0986 486 537	23,8		
	1.8	11.91-12.97	55/66			0986 486 537	23,8		
	1.9 D, TD, TDI	11.91-12.97	47/55/66/81			0986 486 537	23,8		
	2.0	11.91-12.97	79/85			0986 486 537	23,8		
	2.8	01.92-12.97	120/128			0986 486 537	23,8		
	1.4	11.91-12.97	44		SBR	0 204 131 697^A			
					TBR	0986 482 007^A			
	1.6	09.92-12.97	55/74		SBR	0 204 131 697^A			
					TBR	0986 482 007^A			
	1.8	11.91-12.97	55/66		SBR	0 204 131 697^A			
					TBR	0986 482 007^A			
	1.9 D, SDI, TD, TDI	11.91-12.97	47/55/66/81		SBR	0 204 131 697^A			
					TBR	0986 482 007^A			
	2.0	11.91-12.97	79/85		SBR	0 204 131 697^A			
					TBR	0986 482 007^A			
	2.8	01.92-12.97	120/128		SBR	0 204 131 697^A			
					TBR	0986 482 007^A			

de

Gegenüberstellung
online verfügbar

en

Cross-reference
online available

fr

Tableaux de corres-
pondance en ligne
disponible

it

Comparazione
disponibile online

es

Equivalencias
disponible online

nl

Tegenoverstelling
online beschikbaar

sv

Jämförelse finns
online

pt

Confrontação
disponível online

cs

Porovnání k dispozici
online

ru

Сопоставление
онлайн-сравнение



1 Product search
2 Show details
3 Comparisons

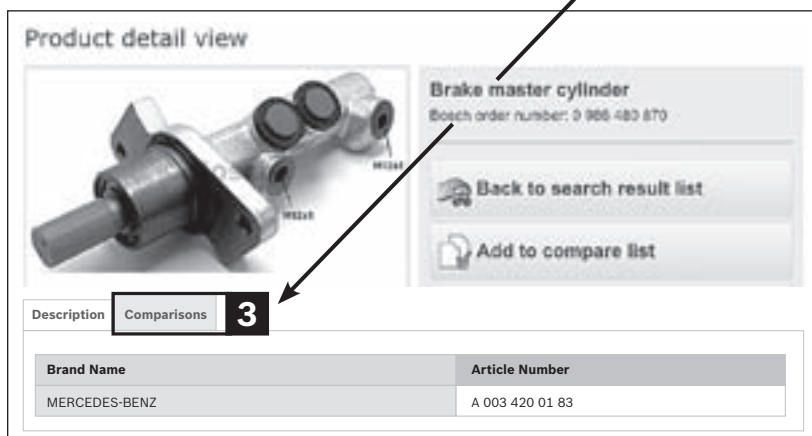
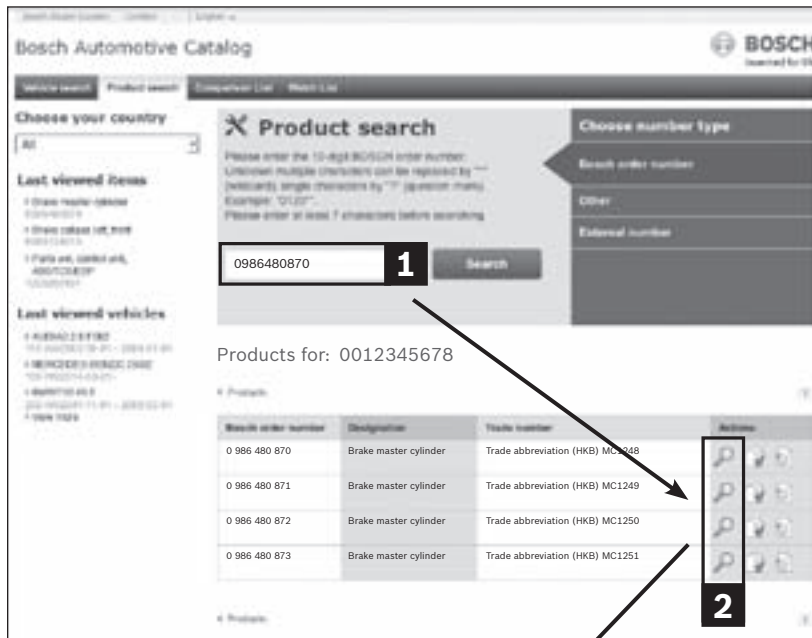

www.bosch-automotive-catalog.com

Einfacher und schneller Zu-
griff auf Bestellnummern von
Herstellern anderer Marken,
für die es einbaugleiche
Bosch-Produkte gibt.

Easier and faster access to
order numbers of manu-
facturers of different brands
for which Bosch products
exist that have an equivalent
design.

Accès rapide et simple aux
références de commande
des fabricants d'autres
marques pour lesquels il
existe des produits Bosch
de montage identique.

Accesso rapido e semplice ai
numeri d'ordine di produttori
di altri marchi, per i quali
esistono prodotti Bosch con
uguale installazione.

Acceso sencillo y rápido
a los números de pedido de
fabricantes de otras marcas
para las que hay productos
Bosch de montaje similar.

Eenvoudiger en snelle
toegang tot bestelnummers
van fabrikanten van andere
merken, waarvoor op
dezelfde wijze inbouwbare
Bosch-producten bestaan.

Enklare och snabbare
åtkomst till beställnings-
nummer från tillverkare
av andra märken som har
produkter som liknar Bosch
monteringsmässigt.

Acesso simples e mais
rápido aos números de
encomenda dos fabricantes
de outras marcas, para
os quais existem produtos
Bosch semelhantes.

Jednodušší a rychlejší
přístup k objednacím číslům
výrobců jiných značek,
pro které existují produkty
Bosch stejné vestavby.

Простой и быстрый
доступ к номерам заказа
изготовителей прочих
марок, для которых
существуют продукты
Bosch с аналогичным
способом установки.



de

Bosch bietet ein innovatives Bremsen-Komplettprogramm.

Beste Voraussetzungen für Handel und Werkstatt gewährleisten:

- ▶ Hohe Marktabdeckung mit über 10.000 Produkten
- ▶ Abgestimmte Diagnose- und Prüftechnik
- ▶ Umfassende Verkaufsunterstützung

en

Bosch offers a complete program of innovative brake systems.

Aftermarket resellers and service centers are able to enjoy maximum benefits based on:

- ▶ high levels of market coverage, with over 10,000 products
- ▶ coordinated diagnostic and testing technology
- ▶ comprehensive sales support

fr

Bosch propose une gamme de freins complète et innovante.

Pour le revendeur et le garagiste, les meilleures conditions sont remplies grâce à:

- ▶ une couverture élevée du marché assurée par plus de 10.000 produits
- ▶ un matériel de diagnostic et de contrôle adapté
- ▶ une assistance commerciale complète

it

Bosch offre un innovativo programma completo per freni.

I migliori presupposti per l'aftermarket e l'officina sono garantiti da:

- ▶ Elevata copertura del mercato con oltre 10.000 prodotti
- ▶ Tecnica di prova e di diagnosi su misura
- ▶ Ampio supporto alla vendita

es

Bosch ofrece un innovador programa completo de frenos.

Garantía de las mejores condiciones para el distribuidor y el taller:

- ▶ Alta cobertura de mercado con más de 10.000 referencias.
- ▶ Técnica coordinada de diagnóstico y comprobación
- ▶ Amplio apoyo comercial

nl

Bosch biedt een innovatief en compleet remprogramma.

De beste voorwaarden voor handel en garages garanderen:

- ▶ Een hoge marktdekking met meer dan 10.000 producten
- ▶ Een hierop afgestemde diagnose- en testtechniek
- ▶ Een uitgebreide verkoopondersteuning

sv

Bosch erbjuder ett innovativt bromskomplettprogram.

De bästa förutsättningarna för handel och verkstad garanterar:

- ▶ Hög marknadstäckning med över 10.000 produkter
- ▶ Avstämde diagnos- och testteknik
- ▶ Omfattande säljstöd

pt

A inovadora gama de travões da Bosch.

Garantia dos melhores requisitos para o comércio e oficinas:

- ▶ Elevada cobertura do mercado com mais de 10.000 produtos
- ▶ Tecnologia de diagnóstico e de teste comprovada
- ▶ Suporte de vendas abrangente

cs

Bosch nabízí inovativní kompletní brzdový program.

Jsou zaručeny nejlepší předpoklady pro obchod a servis:

- ▶ Vysoké pokrytí trhu více než 10000 produkty
- ▶ Přizpůsobená diagnostika a zkušební technika
- ▶ Rozsáhlá podporaprodaje

ru

Bosch предлагает инновационную полную программу тормозных систем.

Наилучшие условия для торговых партнеров и станций техобслуживания обеспечиваются за счет:

- ▶ высокой степени удовлетворения спроса на рынке благодаря наличию более 10.000 изделий
- ▶ согласованного диагностического и испытательного оборудования
- ▶ всесторонней поддержке продаж

nl

Veilige diagnose. Tijdsbesparende reparatie. Bosch-Diagnostics en reserveonderdelen.

sv

Säker diagnos. Tidsbesparande reparation. Bosch-Diagnostics och reservdelar.

pt

Diagnóstico seguro. Reparação rápida. Bosch-Diagnostics e peças sobressalentes.

cs

Bezpečná diagnostika. Časově úsporná oprava. Bosch-Diagnostics a náhradní díly.

ru

Надежная диагностика. Ремонт с выигрышем во времени. Диагностика и запасные части Bosch.



Alles uit één hand. Bosch biedt de werkplaats een volledig programma voor verbetering van de efficiëntie en kwaliteit in het dagelijkse werk. Van de wereldwijd actieve ontwikkelaar en toonaangevende fabrikant van systeemtechniek voor voertuigen komen de reserve onderdelen in bekende originele kwaliteit. Competentie en kwaliteit – voor de toekomst van uw werkplaats.

Allt från samma ställe. Bosch kan erbjuda verkstaden ett komplett program som ökar arbetets effektivitet och kvalitet. Reservdelarna i originalkvalitet kommer från globalt aktiva utvecklare och ledande tillverkare av fordonsystemteknik. Kompetens och kvalitet – för er verkstads framtid.

Tudo do mesmo fornecedor. A Bosch oferece às oficinas um programa completo para aumentar a eficiência e a qualidade do trabalho diário. As peças sobressalentes são fornecidas, com a reconhecida qualidade original, pelo principal fabricante de tecnologia automóvel, que desenvolve os seus projectos em todo o mundo. Competência e qualidade – para o futuro da sua oficina.

Vše z jedné ruky. Bosch nabízí servisu kompletní program pro zvýšení účinnosti a kvality při každodenní práci. Celosvětově aktivní firma v oblasti vývoje a výroby systémové techniky pro vozidla dodává náhradní díly ve známe originální kvalitě. Kompetence a kvalita pro budoucnost vašeho servisu.

Все из одних рук. Bosch предлагает автосервисам полную программу для повышения эффективности и качества ежедневной работы. Действующий по всему миру разработчик и ведущий производитель автомобильного оборудования поставляет запасные части оригинального качества. Компетентность и качество – для будущего Вашего автосервиса.